



US00D798040S

(12) **United States Design Patent** (10) **Patent No.:** **US D798,040 S**
Binder et al. (45) **Date of Patent:** **** Sep. 26, 2017**

(54) **PACKAGING FOR A WOUND THERAPY SYSTEM**

(71) Applicant: **Smith & Nephew PLC**, London (GB)

(72) Inventors: **Ian Binder**, Chippenham (GB); **John Cowan-Hughes**, Bristol (GB); **Beverley Love**, Hessle (GB); **Mark Russell**, Hull (GB); **Peter Sleight**, Cottingham (GB); **Philip Walsh**, Bristol (GB)

(73) Assignee: **Smith & Nephew PLC** (GB)

(**) Term: **15 Years**

(21) Appl. No.: **29/584,531**

(22) Filed: **Nov. 15, 2016**

Related U.S. Application Data

(63) Continuation of application No. 29/563,987, filed on May 10, 2016, now Pat. No. Des. 772,559, which is (Continued)

(51) **LOC (10) Cl.** **03-01**

(52) **U.S. Cl.**
USPC **D3/203.6; D9/432**

(58) **Field of Classification Search**
USPC D9/414, 420-423, 432, 456, 721;
D3/203.1, 203.6, 203.7, 203.8
(Continued)

(56) **References Cited**

U.S. PATENT DOCUMENTS

D134,249 S 11/1942 Button
2,874,707 A 2/1959 Koppel
(Continued)

FOREIGN PATENT DOCUMENTS

FR 1 163 907 10/1958

OTHER PUBLICATIONS

Packaging for Pico Single Use Negative Pressure Wound Therapy System (2012) in 1 page.

(Continued)

Primary Examiner — Ian Simmons

Assistant Examiner — Keith Frank

(74) *Attorney, Agent, or Firm* — Knobbe, Martens, Olson & Bear LLP

(57) **CLAIM**

The ornamental design for packaging for a wound therapy system, as shown and described.

DESCRIPTION

FIG. 1 is a top, front, and left side perspective view of a packaging for a wound therapy system showing my new design in a closed configuration;

FIG. 2 is a front elevation view thereof;

FIG. 3 is a rear elevation view thereof;

FIG. 4 is a right side elevation view thereof;

FIG. 5 is a left side elevation view thereof;

FIG. 6 is a top plan view thereof;

FIG. 7 is a bottom plan view thereof;

FIG. 8 is a top, front, and left side perspective view of the packaging for a wound therapy system of FIG. 1 in a partially open configuration.

FIG. 9 is a front elevation view of the packaging for a wound therapy system of FIG. 1 in a fully open configuration;

FIG. 10 is a rear elevation view thereof;

FIG. 11 is a right side elevation view thereof;

FIG. 12 is a left side elevation view of the packaging of FIG. 1 in a fully open configuration.

FIG. 13 is a top plan view thereof; and,

FIG. 14 is a bottom plan view thereof.

The broken lines in the drawings depict unclaimed subject matter and form no part of the claimed design.

1 Claim, 13 Drawing Sheets

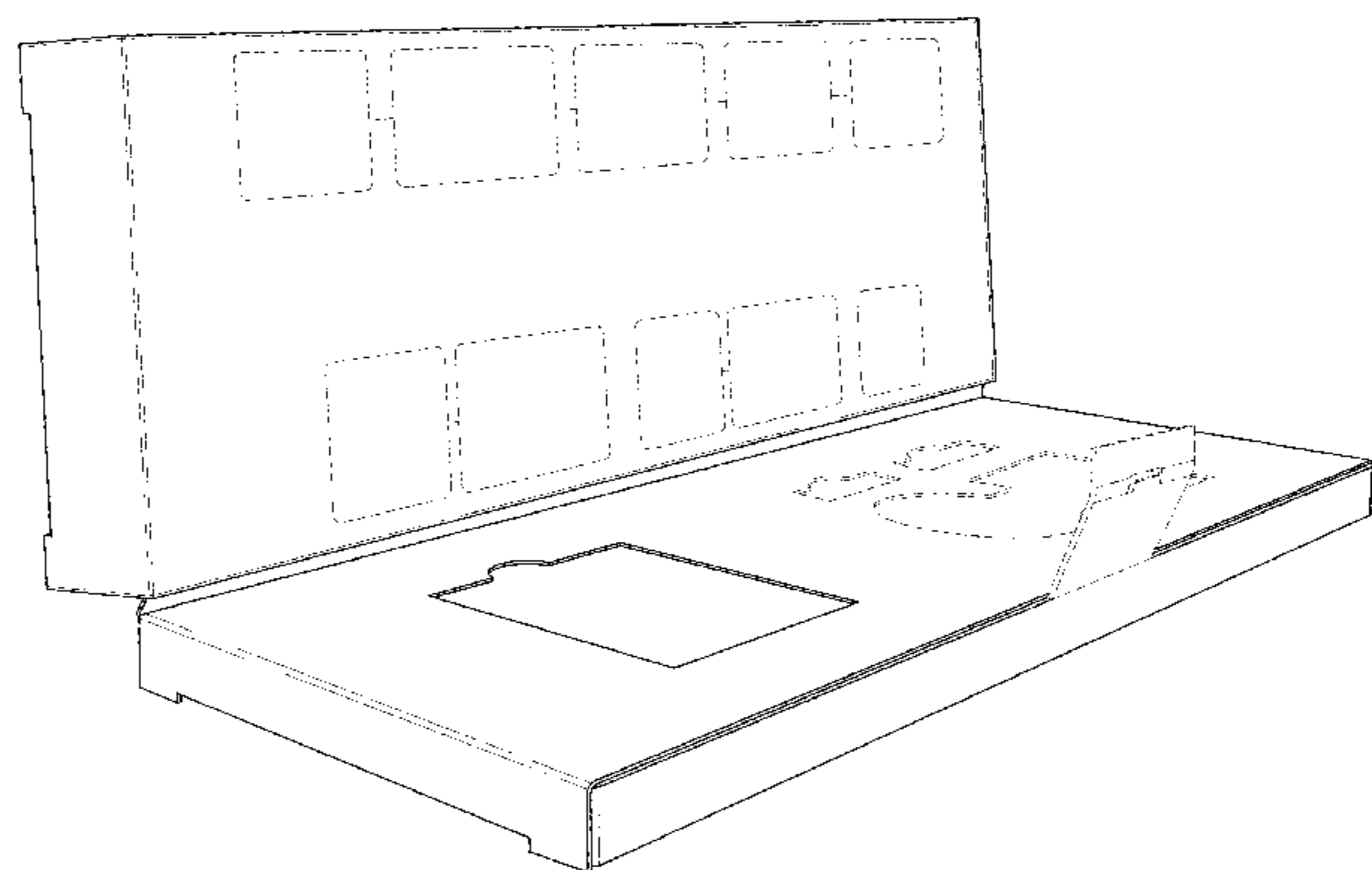
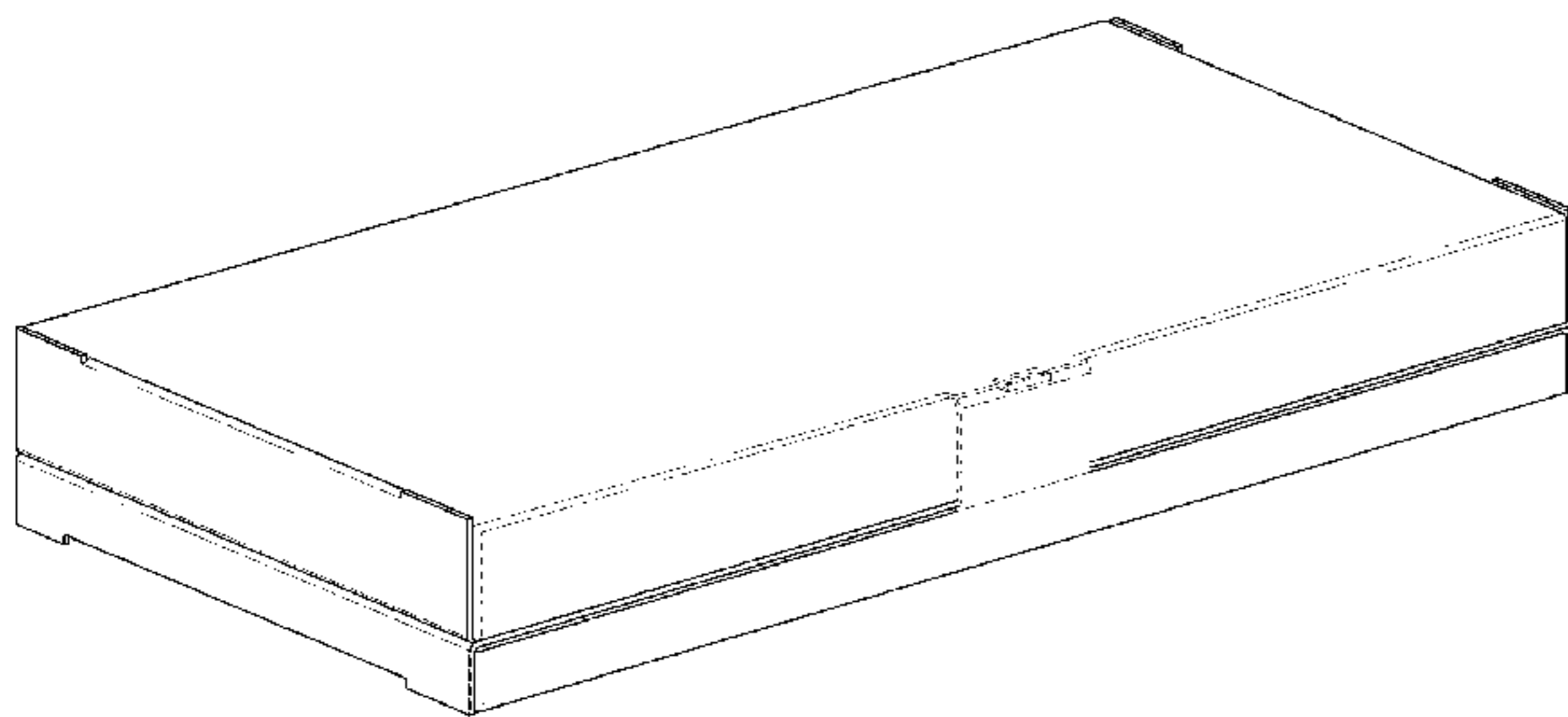

Related U.S. Application Data

a continuation of application No. 29/492,878, filed on Jun. 3, 2014, now Pat. No. Des. 758,851.

(58) **Field of Classification Search**

CPC .. B65D 85/48; B65D 5/0245; B65D 77/0433; B65D 85/46

See application file for complete search history.

(56) **References Cited**

U.S. PATENT DOCUMENTS

3,640,379 A 2/1972 Weingarden
 3,972,328 A 8/1976 Chen
 D254,219 S 2/1980 Papciak
 D267,834 S 2/1983 Yew
 D268,098 S 3/1983 Brown
 D275,425 S 9/1984 Briggs
 D281,836 S 12/1985 Sparkman
 D289,461 S 4/1987 Humphries
 4,977,483 A 12/1990 Perretta
 D313,505 S 1/1991 Leopoldi et al.
 D316,181 S 4/1991 Clifton
 D320,308 S 10/1991 Whitworth
 D327,363 S 6/1992 Farb
 5,238,732 A 8/1993 Krishnan
 D339,287 S 9/1993 Levin
 5,344,024 A 9/1994 Cohu
 D365,754 S 1/1996 Plassier
 D369,295 S * 4/1996 Kobari D9/423
 5,549,584 A 8/1996 Gross
 D389,639 S 1/1998 Priebe
 D393,591 S 4/1998 Baryshyan
 5,759,570 A 6/1998 Arnold
 D396,750 S 8/1998 Slater et al.
 D397,869 S 9/1998 Minhas
 D398,527 S 9/1998 Maceachern et al.
 D420,586 S 2/2000 Maceachern et al.
 D431,902 S * 10/2000 Mellin D3/203.1
 D455,312 S * 4/2002 Myszka D6/407
 6,626,891 B2 9/2003 Ohmstede
 6,913,149 B2 * 7/2005 Gelardi B65D 50/045
 206/1.5
 7,361,184 B2 4/2008 Joshi
 7,381,859 B2 6/2008 Hunt et al.
 D579,195 S 10/2008 Kagawa

D589,798 S * 4/2009 Liipola D9/456
 7,569,742 B2 8/2009 Haggstrom et al.
 7,615,036 B2 11/2009 Joshi et al.
 D606,394 S 12/2009 Stewart
 D607,717 S 1/2010 Hodges
 7,699,823 B2 4/2010 Haggstrom et al.
 D618,546 S 6/2010 Easterbrook et al.
 D621,125 S * 8/2010 Heintzelman D99/28
 7,775,998 B2 8/2010 Riesinger
 7,811,269 B2 10/2010 Boynton et al.
 7,846,141 B2 12/2010 Weston
 7,910,791 B2 3/2011 Coffey
 7,922,703 B2 4/2011 Riesinger
 7,964,766 B2 6/2011 Blott et al.
 D644,514 S * 9/2011 Robins D9/456
 D645,735 S 9/2011 Clark et al.
 D661,188 S 6/2012 Fahy
 D661,189 S 6/2012 Fahy
 D661,190 S 6/2012 Fahy
 D663,944 S 7/2012 Bouskill
 D668,948 S 10/2012 LaTrobe
 D678,067 S * 3/2013 Jones D9/456
 D682,279 S * 5/2013 Fuchs D14/440
 D687,300 S 8/2013 Jones et al.
 D704,442 S * 5/2014 Chen D3/294
 D708,055 S 7/2014 Elston et al.
 D723,792 S 3/2015 Anderson et al.
 D729,515 S * 5/2015 Slimane D3/242
 D730,728 S 6/2015 Fath
 9,241,873 B2 1/2016 Upchurch et al.
 D750,478 S 3/2016 Kiss
 D761,023 S 7/2016 Tramontana
 D766,713 S * 9/2016 Kiss D9/421
 2003/0230509 A1 * 12/2003 Fitzgerald B42F 7/14
 206/472
 2007/0225663 A1 9/2007 Watt et al.
 2008/0306456 A1 12/2008 Riesinger

OTHER PUBLICATIONS

Protz, Kerstin: "Modern Wundauflagen unterstützen Heilungsprozess", Wundversorgung: Indikation and Anwendung, Geriatrie Journal Apr. 2005, pp. 3333-3339.
 Smith & Nephew, "PICO packaging reduction", Jun. 2014, <http://www.smith-nephew.com/news-and-media/case-studies/picosntm-packaging-reduction/>.

* cited by examiner

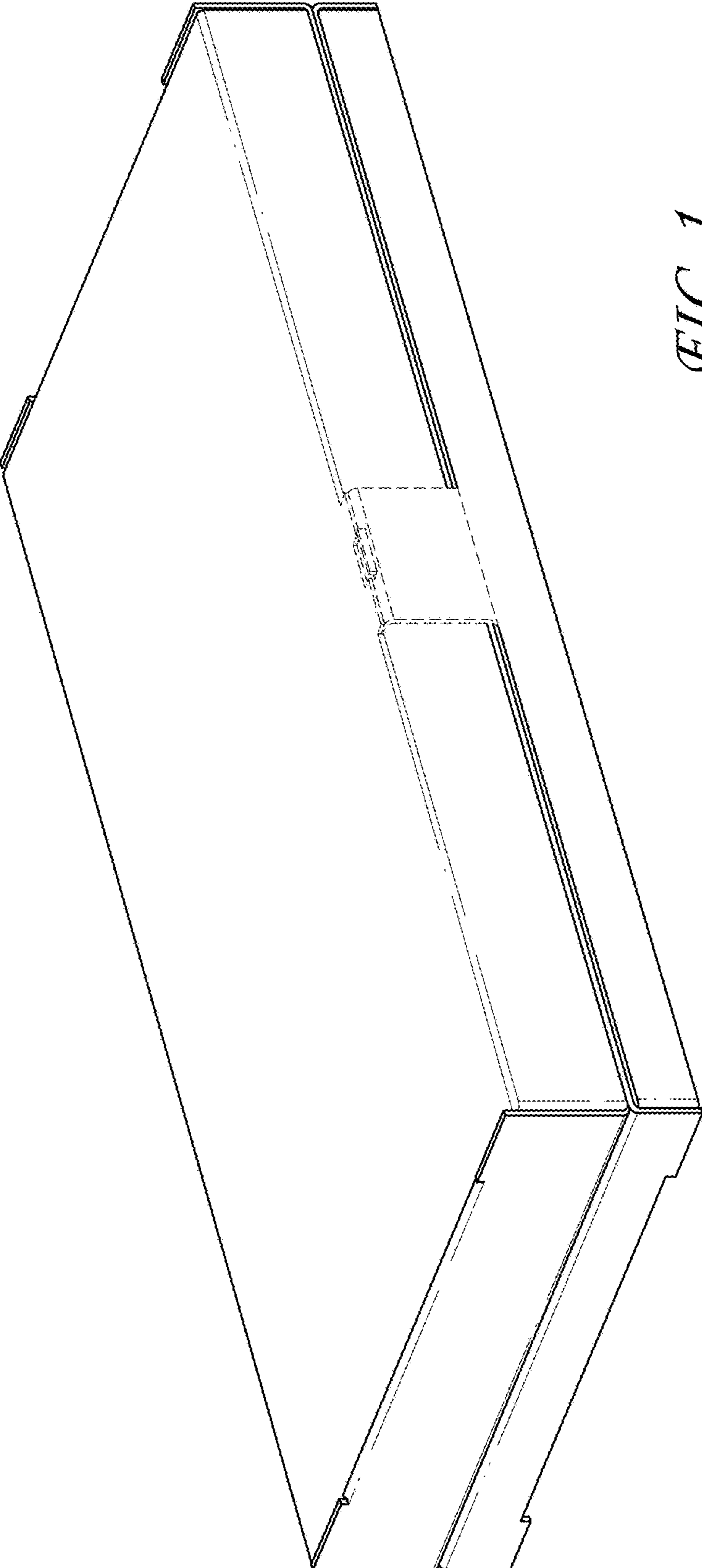

FIG. 1

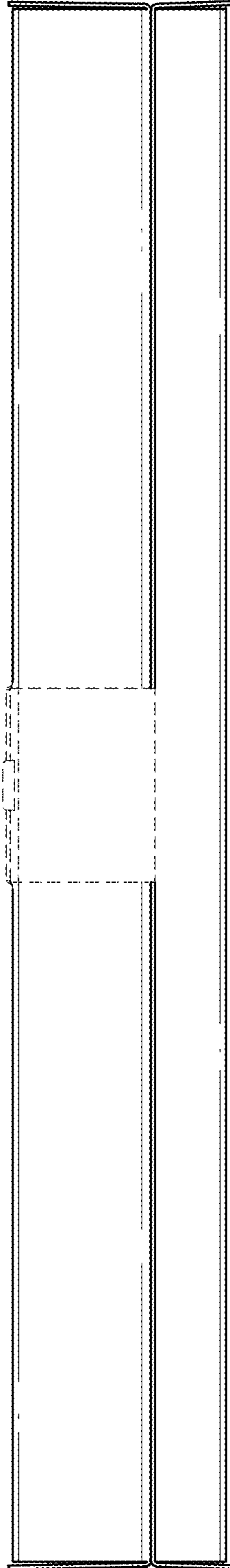

FIG. 2

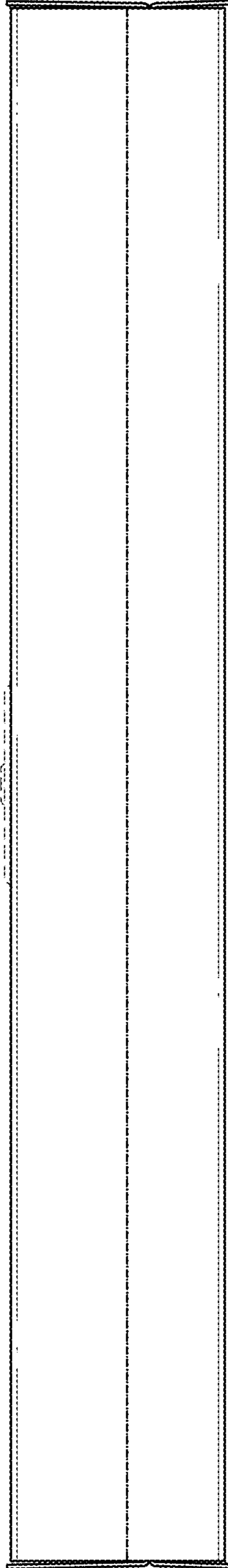

FIG. 3

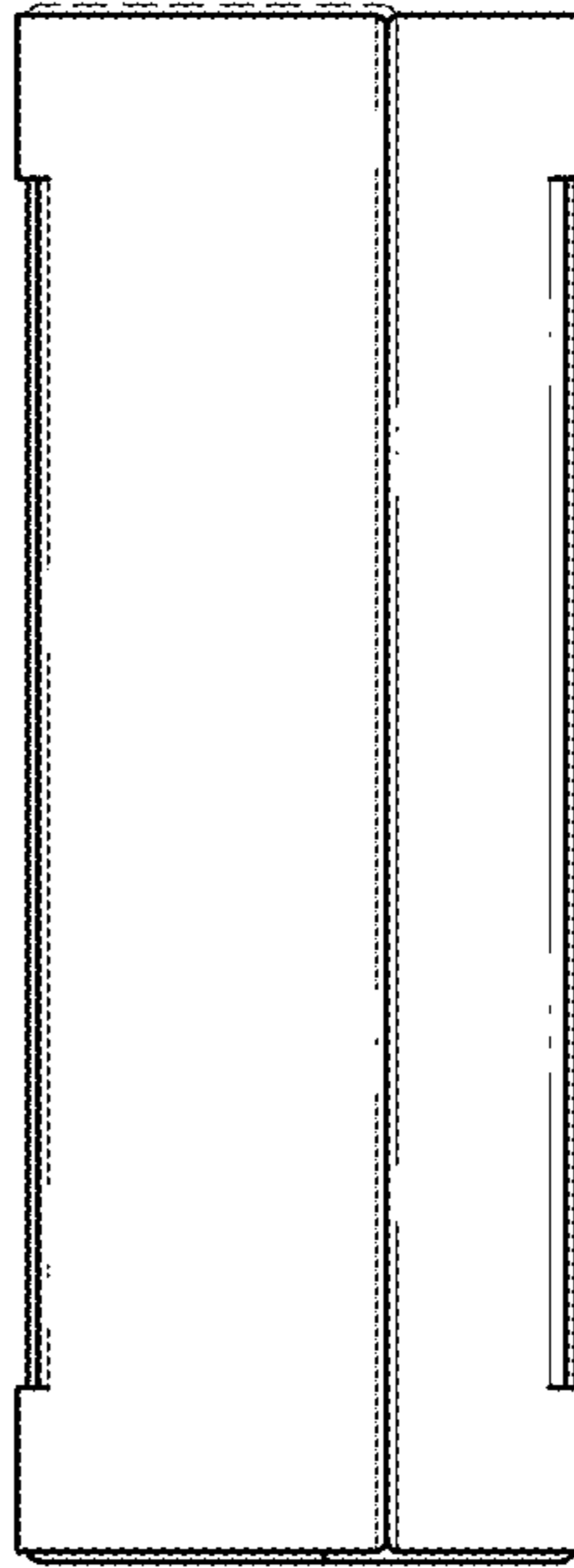

FIG. 4

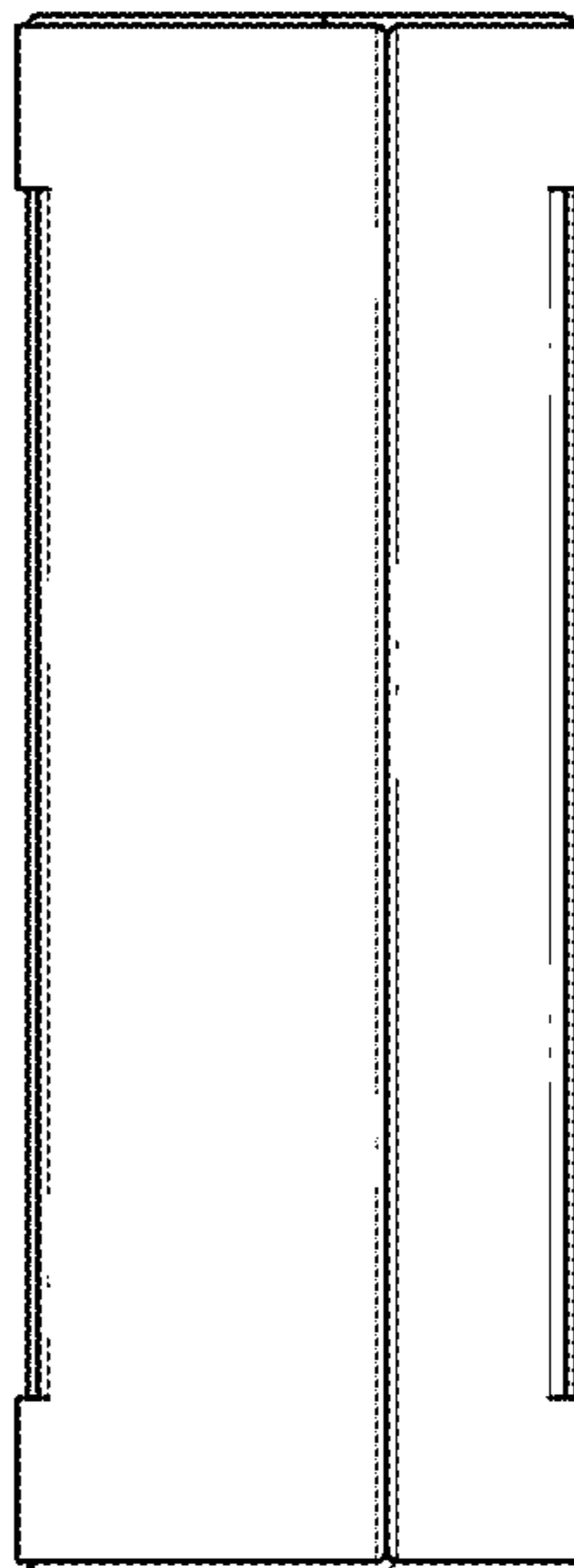

FIG. 5



FIG. 6

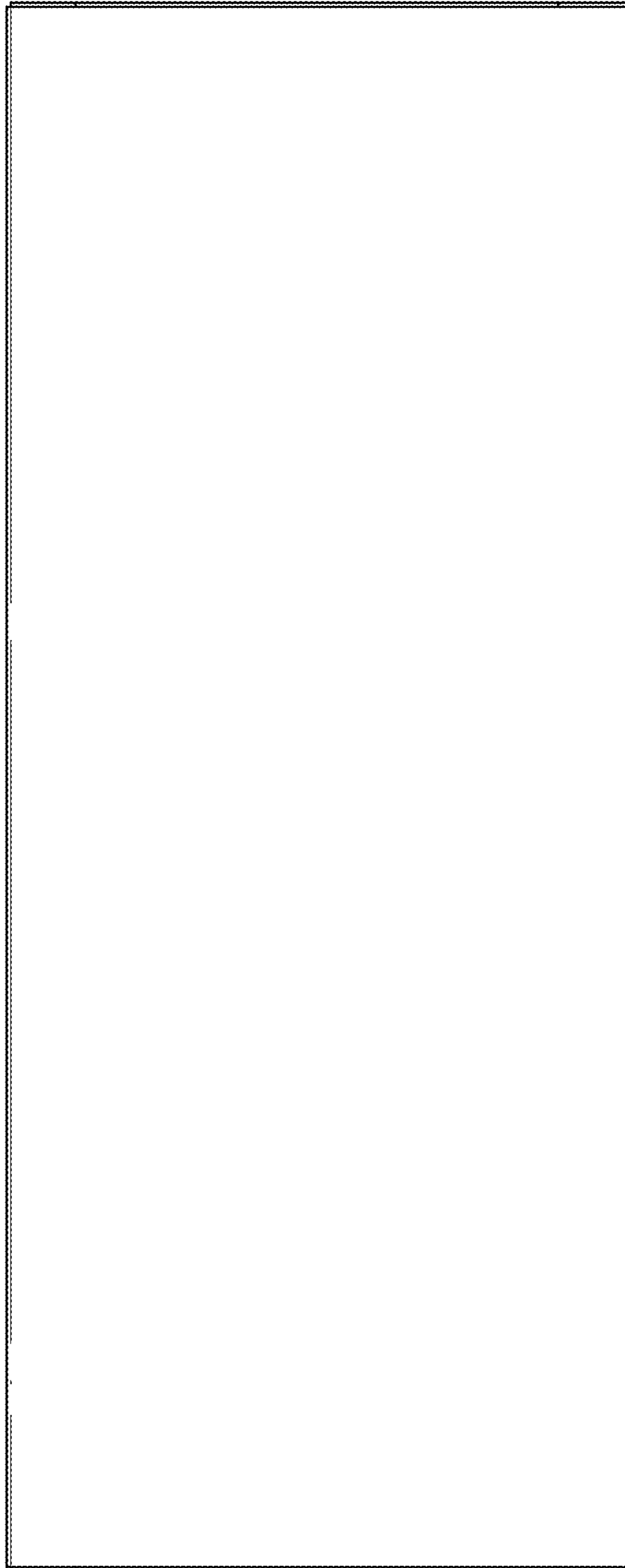

FIG. 7

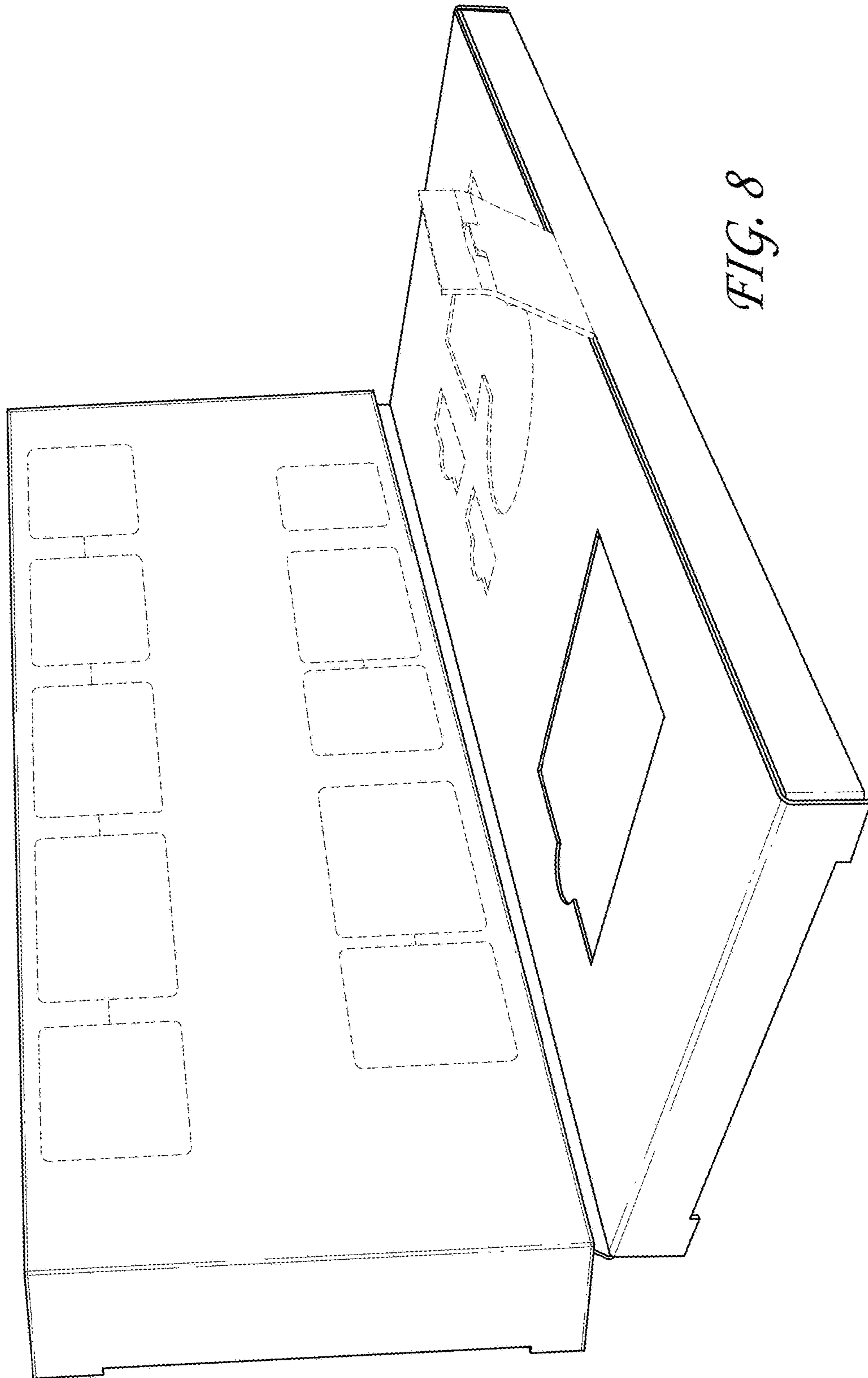

FIG. 8

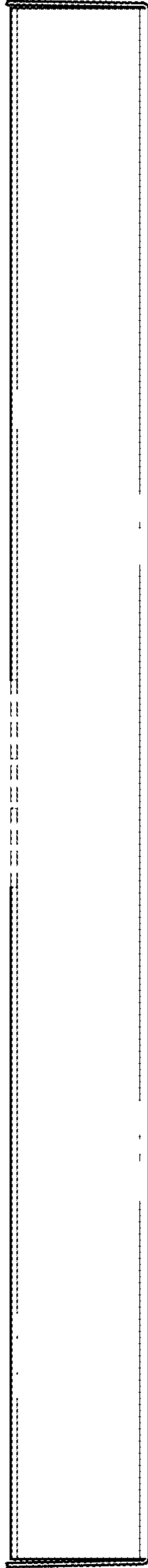

FIG. 9

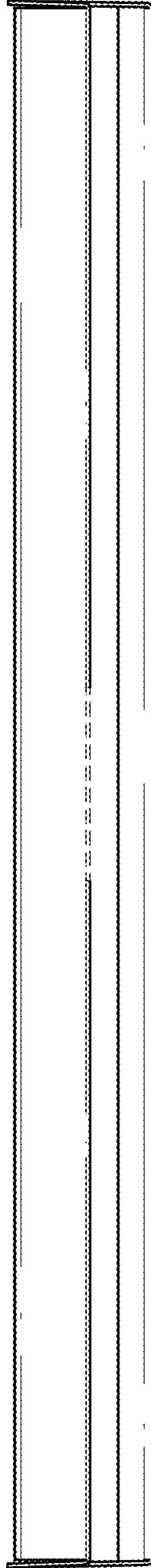

FIG. 10

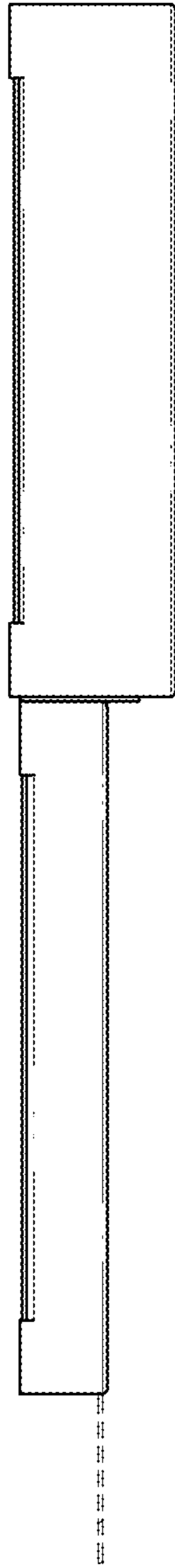

FIG. 11

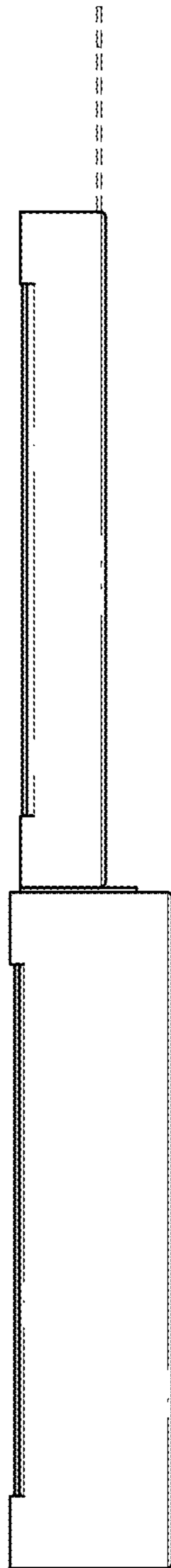

FIG. 12

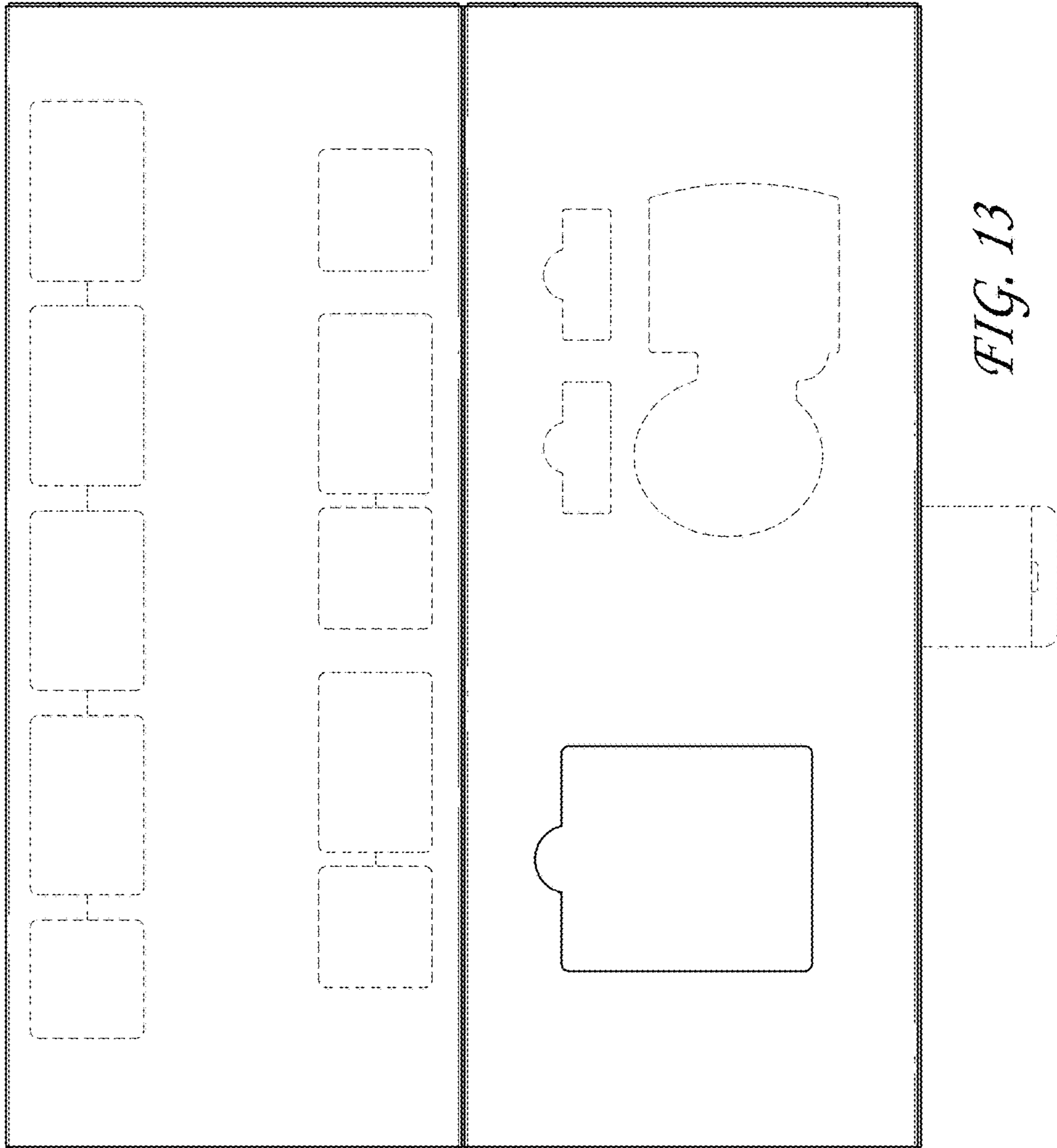

FIG. 13

FIG. 14

