



US00D798020S

(12) **United States Design Patent** (10) **Patent No.:** **US D798,020 S**
Magnusson (45) **Date of Patent:** **** Sep. 19, 2017**

- (54) **SHOPPING CART BASKET**
- (71) Applicant: **Advance Carts Inc.**, Boca Raton, FL (US)
- (72) Inventor: **Marcus Magnusson**, Boca Raton, FL (US)
- (73) Assignee: **Advance Carts Inc.**, Boca Raton, FL (US)
- (**) Term: **15 Years**
- (21) Appl. No.: **29/558,943**
- (22) Filed: **Mar. 23, 2016**
- (51) **LOC (10) Cl.** **12-02**
- (52) **U.S. Cl.**
USPC **D34/27**
- (58) **Field of Classification Search**
USPC D34/12-27; 280/33.992, 33.991, 47.34, 280/79.11
CPC B62B 3/1404; B62B 3/146; B62B 3/1476
See application file for complete search history.

- D644,810 S * 9/2011 Peota D34/17
- D646,041 S * 9/2011 Berthiaume D34/21
- D659,936 S * 5/2012 Berthiaume D34/27

* cited by examiner

Primary Examiner — Cynthia Ramirez
(74) *Attorney, Agent, or Firm* — Murtha Cullina LLP; Anthony P. Gangemi

(57) **CLAIM**

The ornamental design for a shopping cart basket, as shown and described.

DESCRIPTION

FIG. 1 is a right side view of a shopping cart basket showing my new design;
 FIG. 2 is a left side view of the shopping cart basket shown in FIG. 1;
 FIG. 3 is a rear view of the shopping cart basket shown in FIG. 1;
 FIG. 4 is a front view of the shopping cart basket shown in FIG. 1;
 FIG. 5 is a top view of the shopping cart basket shown in FIG. 1;
 FIG. 6 is a bottom view of the shopping cart basket shown in FIG. 1;
 FIG. 7 is a top isometric view of the shopping cart basket shown in FIG. 1; and,
 FIG. 8 is a bottom isometric view of the shopping cart basket shown in FIG. 1.

1 Claim, 8 Drawing Sheets

(56) **References Cited**

U.S. PATENT DOCUMENTS

- D400,679 S * 11/1998 Kern D34/27
- D528,732 S * 9/2006 Hubbard D34/27
- D546,021 S * 7/2007 Splain D34/27
- D564,172 S * 3/2008 Steinhobel D34/12
- D582,122 S * 12/2008 Splain D34/27
- D628,759 S * 12/2010 Walter D34/27
- D641,532 S * 7/2011 Peota D34/17

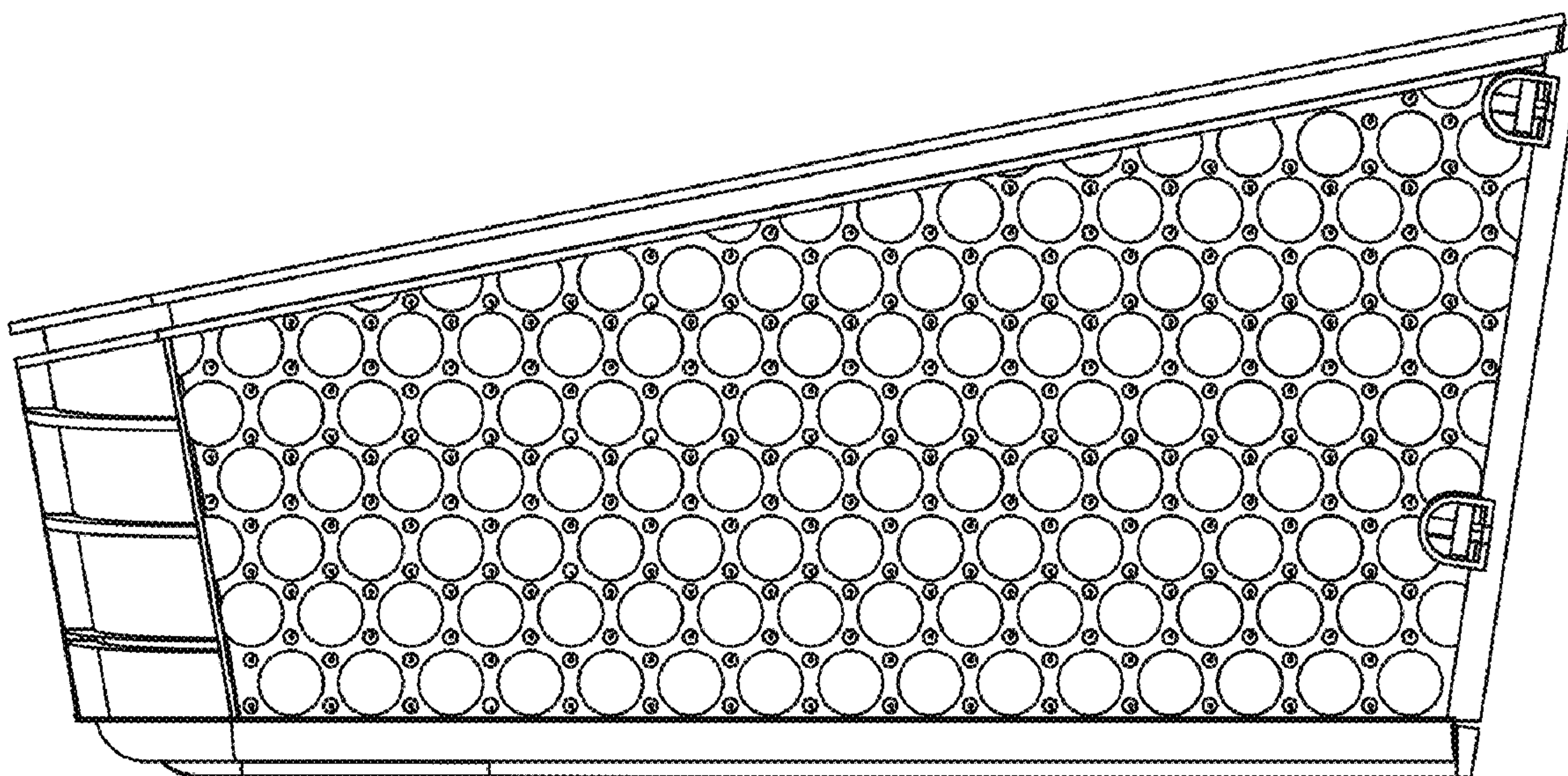

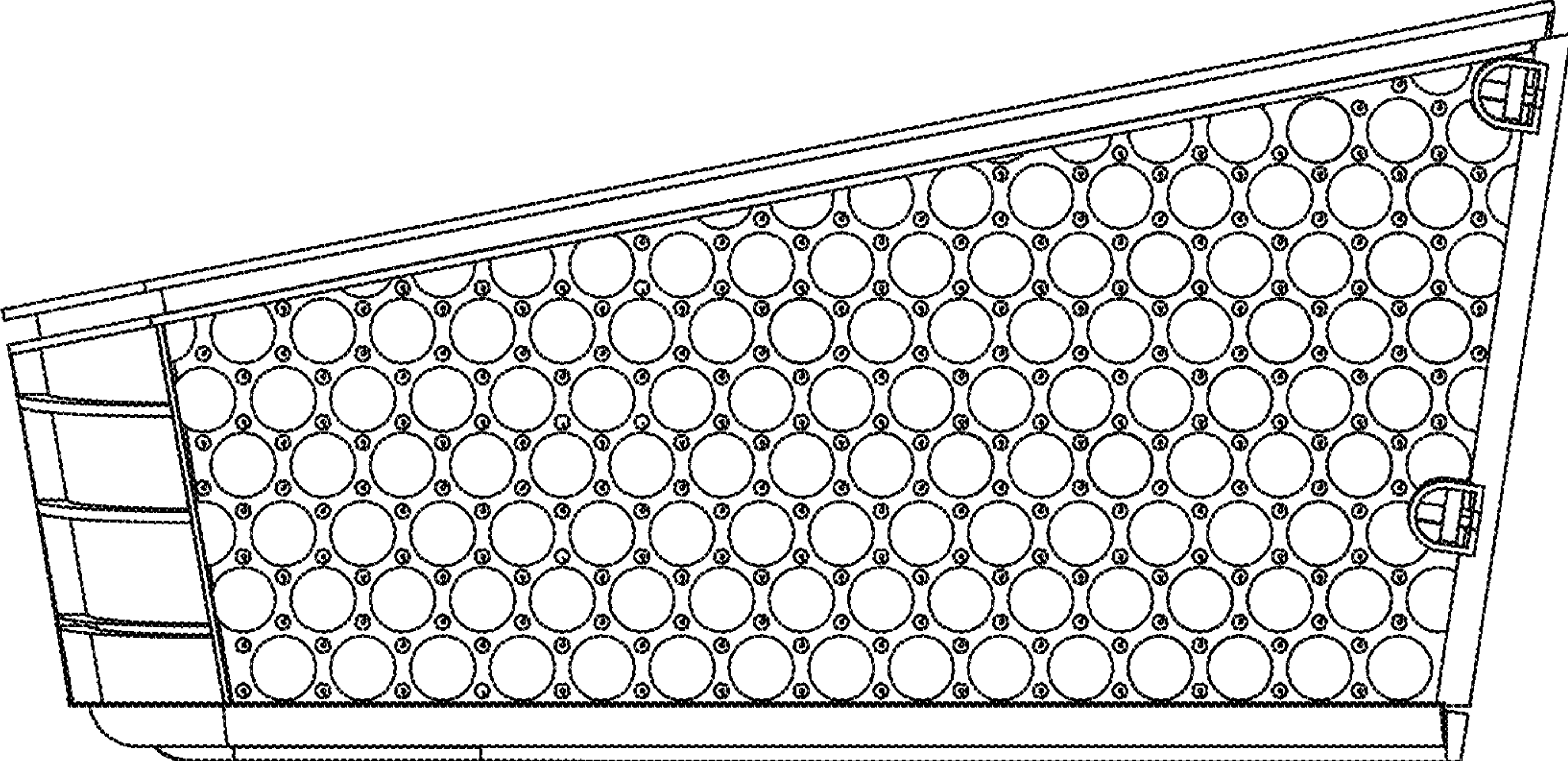

FIG. 1

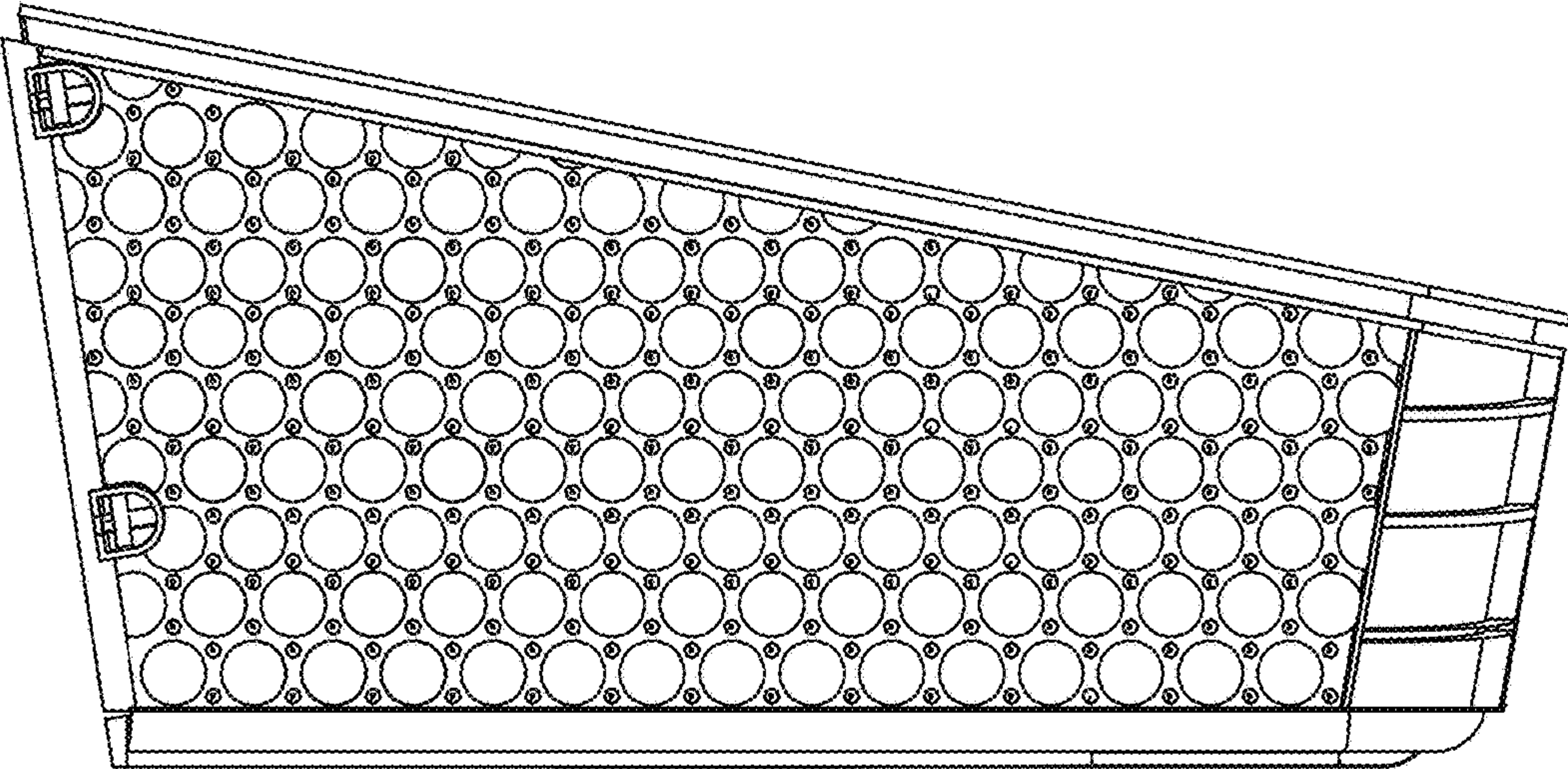

FIG. 2

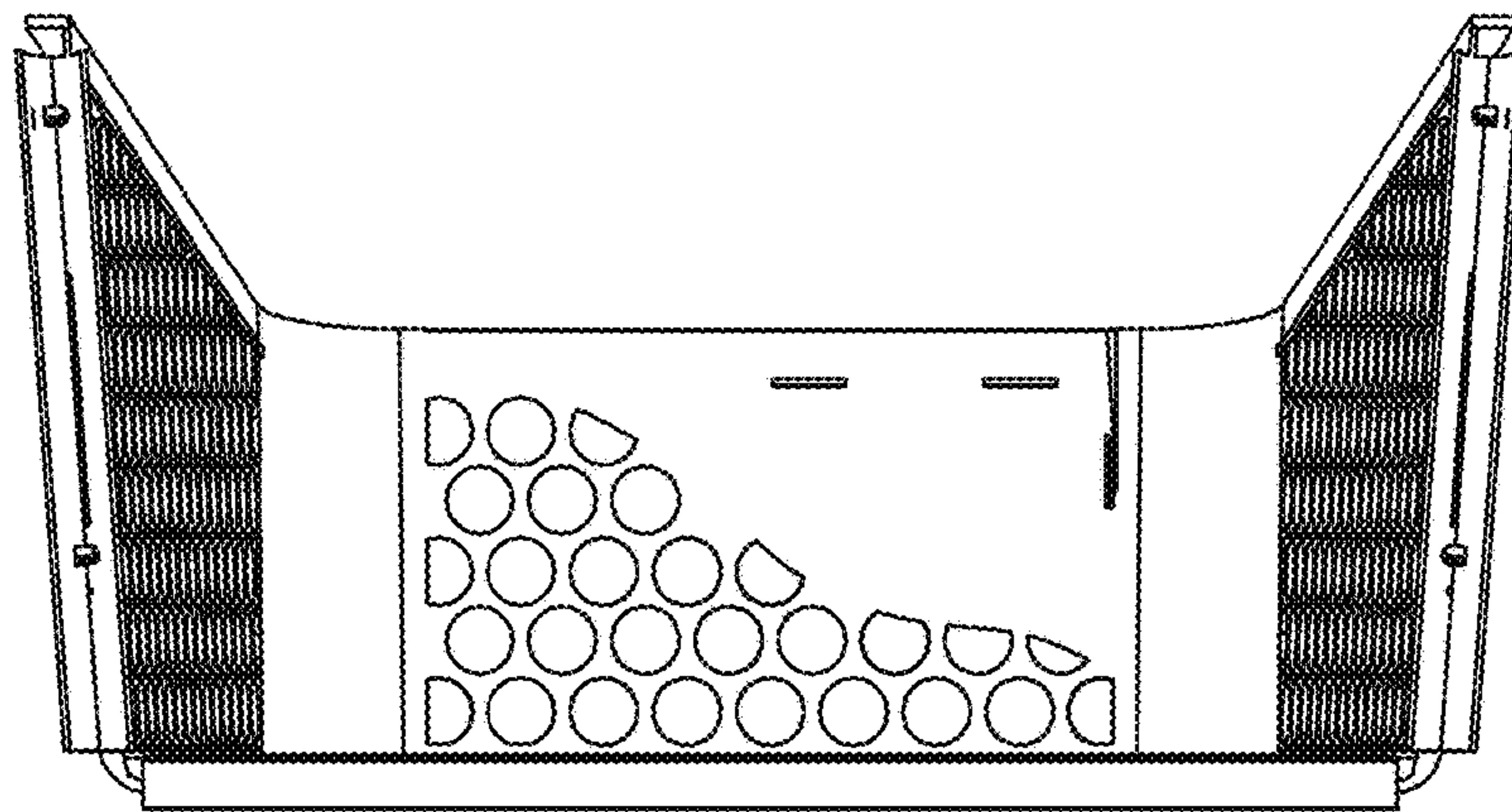

FIG. 3

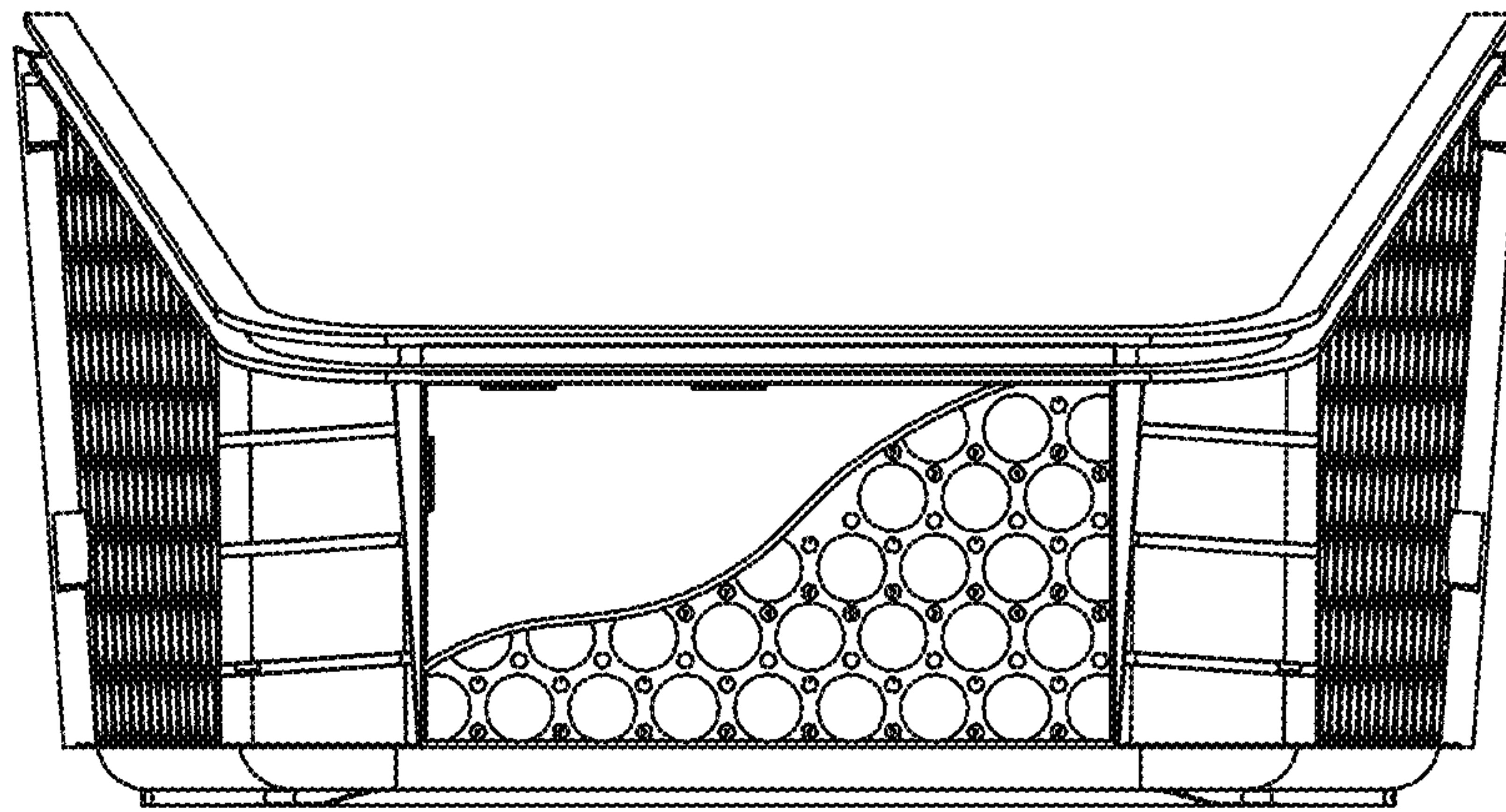

FIG. 4

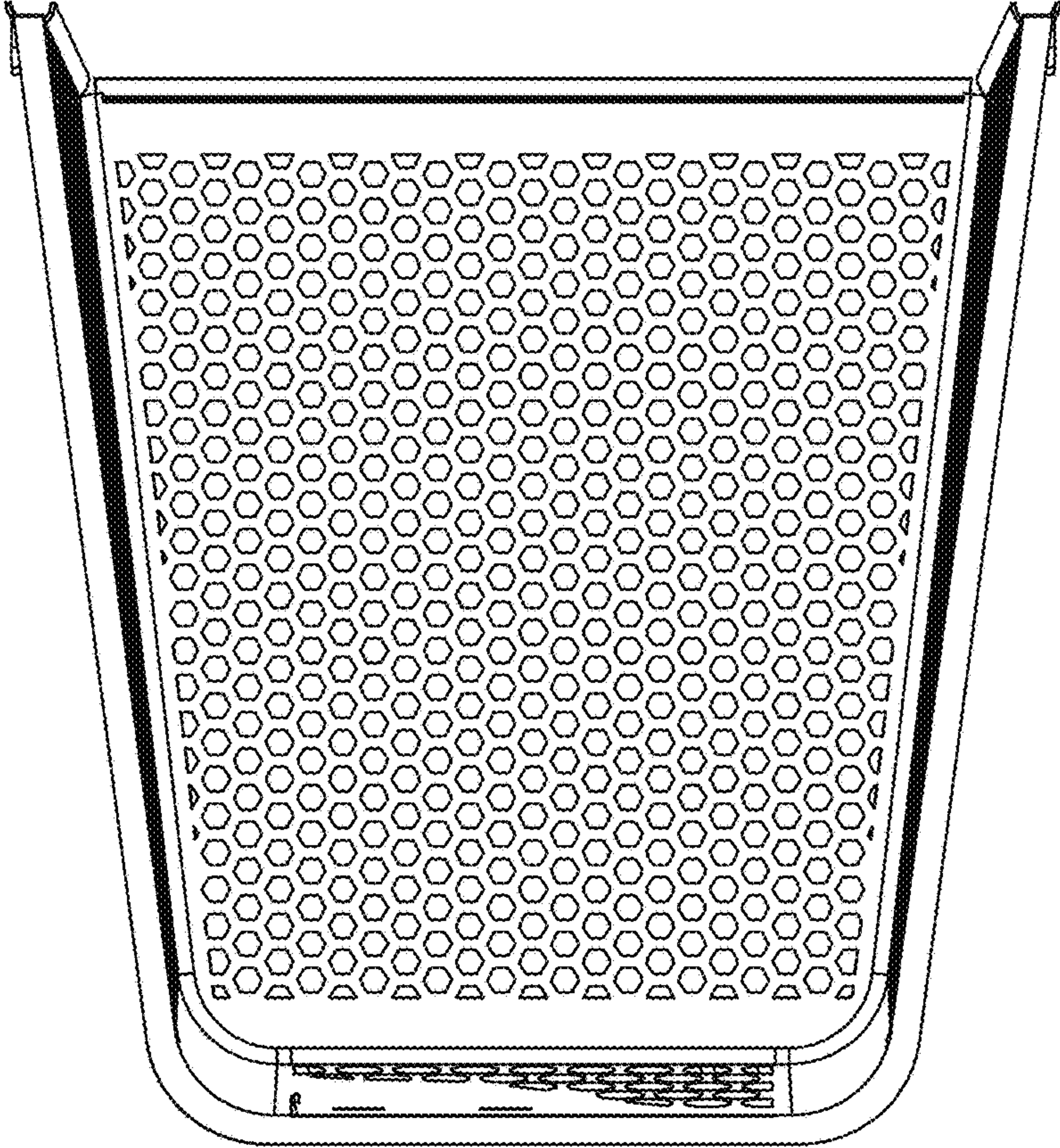

FIG. 5

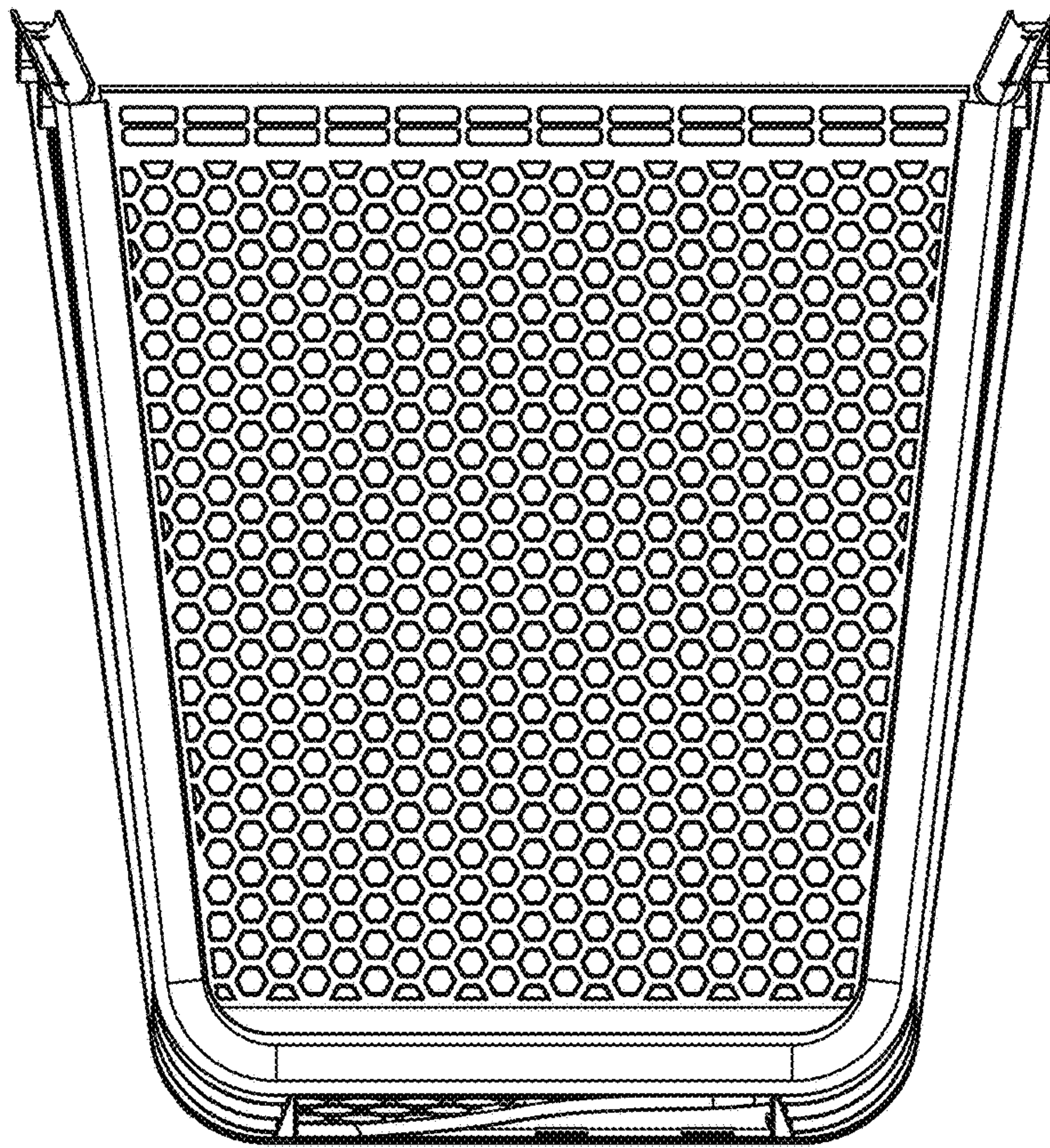

FIG. 6

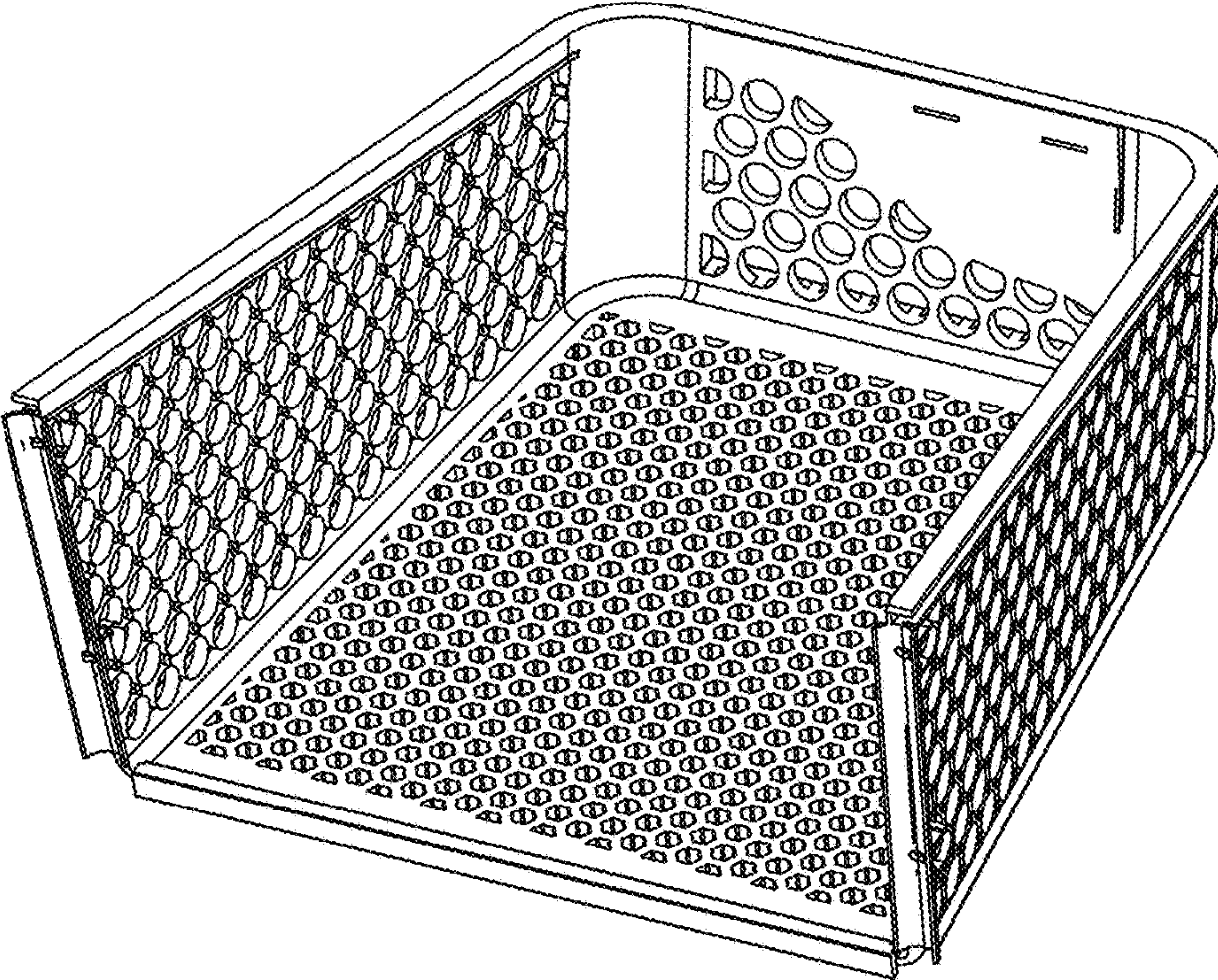

FIG. 7

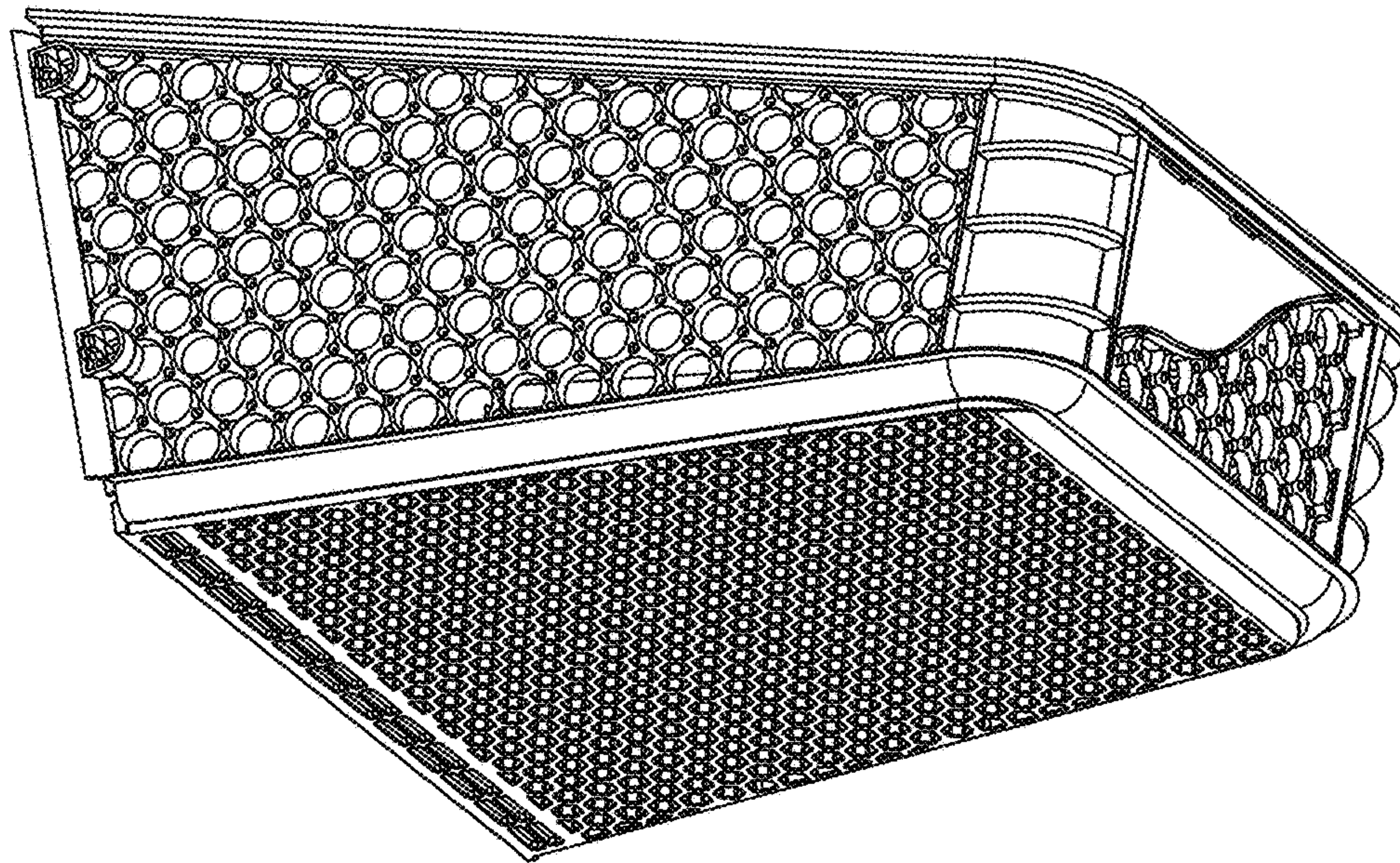

FIG. 8