



US00D797964S

(12) **United States Design Patent** (10) **Patent No.:** **US D797,964 S**
Hill (45) **Date of Patent:** **** Sep. 19, 2017**

(54) **HEAD LAMP**

(71) Applicant: **Jaguar Land Rover Limited**, Whitley, Coventry (GB)

(72) Inventor: **Andrew Hill**, Whitley (GB)

(73) Assignee: **Jaguar Land Rover Limited**, Whitley, Coventry (GB)

(**) Term: **15 Years**

(21) Appl. No.: **29/546,807**

(22) Filed: **Nov. 25, 2015**

(30) **Foreign Application Priority Data**

Jun. 15, 2015 (EM) 002719328

(51) **LOC (10) Cl.** **26-06**

(52) **U.S. Cl.**
USPC **D26/28**

(58) **Field of Classification Search**
USPC D26/28-36; 362/80-83, 267-269,
362/459-468, 475-478, 485-487

(Continued)

(56) **References Cited**

U.S. PATENT DOCUMENTS

D637,319 S * 5/2011 Jeong D26/28
D691,302 S * 10/2013 Lai D26/28

(Continued)

Primary Examiner — Marcus Jackson

(74) *Attorney, Agent, or Firm* — Wood Herron & Evans LLP

(57) **CLAIM**

The ornamental design for a head lamp, as shown and described.

DESCRIPTION

FIG. 1 is a front left perspective view of a head lamp for a vehicle according to the present invention.

FIG. 2 is a left side view of the head lamp shown in FIG. 1. FIG. 3 is a front view thereof.

FIG. 4 is a right side view thereof.

FIG. 5 is a top view thereof.

FIG. 6 is a front left perspective view of the head lamp shown in FIG. 1, with the head lamp shown mounted on a vehicle that is depicted in de-emphasized and halftone portions. These de-emphasized portions form no part of the claimed invention. More particularly, in FIG. 6, the head lamp of the present invention is shown within the broken line, and any elements shown outside of the broken line form no part of the claimed invention, but are instead included to show environmental aspects of the claimed invention.

FIG. 7 is a front left perspective view of a head lamp for a vehicle according to an alternative embodiment of the present invention.

FIG. 8 is a left side view of the head lamp shown in FIG. 7. FIG. 9 is a front view thereof.

FIG. 10 is a right side view thereof.

FIG. 11 is a top view thereof.

FIG. 12 is a front left perspective view of the head lamp shown in FIG. 7, with the head lamp shown mounted on a vehicle that is depicted in de-emphasized and halftone portions. These de-emphasized portions form no part of the claimed invention. More particularly, in FIG. 12, the head lamp of the present invention is shown within the broken line, and any elements shown outside of the broken line form no part of the claimed invention, but are instead included to show environmental aspects of the claimed invention.

FIG. 13 is a front left perspective view of a head lamp for a vehicle according to another alternative embodiment of the present invention.

FIG. 14 is a left side view of the head lamp shown in FIG. 13.

FIG. 15 is a front view thereof.

FIG. 16 is a right side view thereof.

FIG. 17 is a top view thereof.

FIG. 18 is a front left perspective view of the head lamp shown in FIG. 13, with the head lamp shown mounted on a vehicle that is depicted in de-emphasized and halftone portions. These de-emphasized portions form no part of the claimed invention. More particularly, in FIG. 18, the head lamp of the present invention is shown within the broken

(Continued)

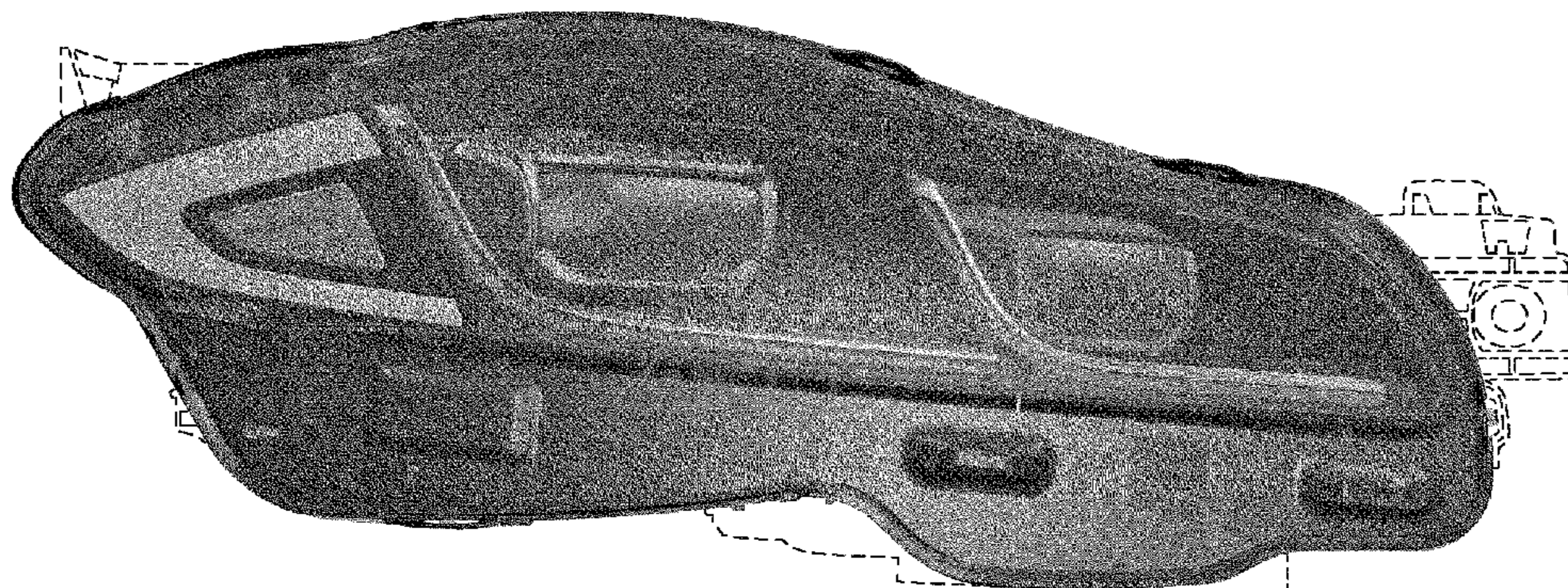

line, and any elements shown outside of the broken line form no part of the claimed invention, but are instead included to show environmental aspects of the claimed invention.

FIG. 19 is a front left perspective view of a head lamp for a vehicle according to still another alternative embodiment of the present invention.

FIG. 20 is a left side view of the head lamp shown in FIG. 19.

FIG. 21 is a front view thereof.

FIG. 22 is a right side view thereof.

FIG. 23 is a top view thereof; and,

FIG. 24 is a front left perspective view of the head lamp shown in FIG. 19, with the head lamp shown mounted on a vehicle that is depicted in de-emphasized and halftone portions. These de-emphasized portions form no part of the claimed invention. More particularly, in FIG. 24, the head lamp of the present invention is shown within the broken line, and any elements shown outside of the broken line form no part of the claimed invention, but are instead included to show environmental aspects of the claimed invention.

In FIGS. 1-5, 7-11, 13-17, and 19-23, the broken lines are shown for environmental purposes only and form no part of the invention.

1 Claim, 16 Drawing Sheets

(58) **Field of Classification Search**

CPC F21S 48/00; F21S 48/10; F21S 48/115;
F21S 48/225; F21S 48/1233; F21S
48/1266; F21S 48/1388; F21S 48/2268;
F21V 21/04

See application file for complete search history.

(56) **References Cited**

U.S. PATENT DOCUMENTS

D708,366	S	*	7/2014	Minamisawa	D26/28
D740,463	S	*	10/2015	Ko	D26/28
D745,726	S	*	12/2015	McMahan	D26/28
D750,299	S	*	2/2016	Morikawa	D26/28

* cited by examiner

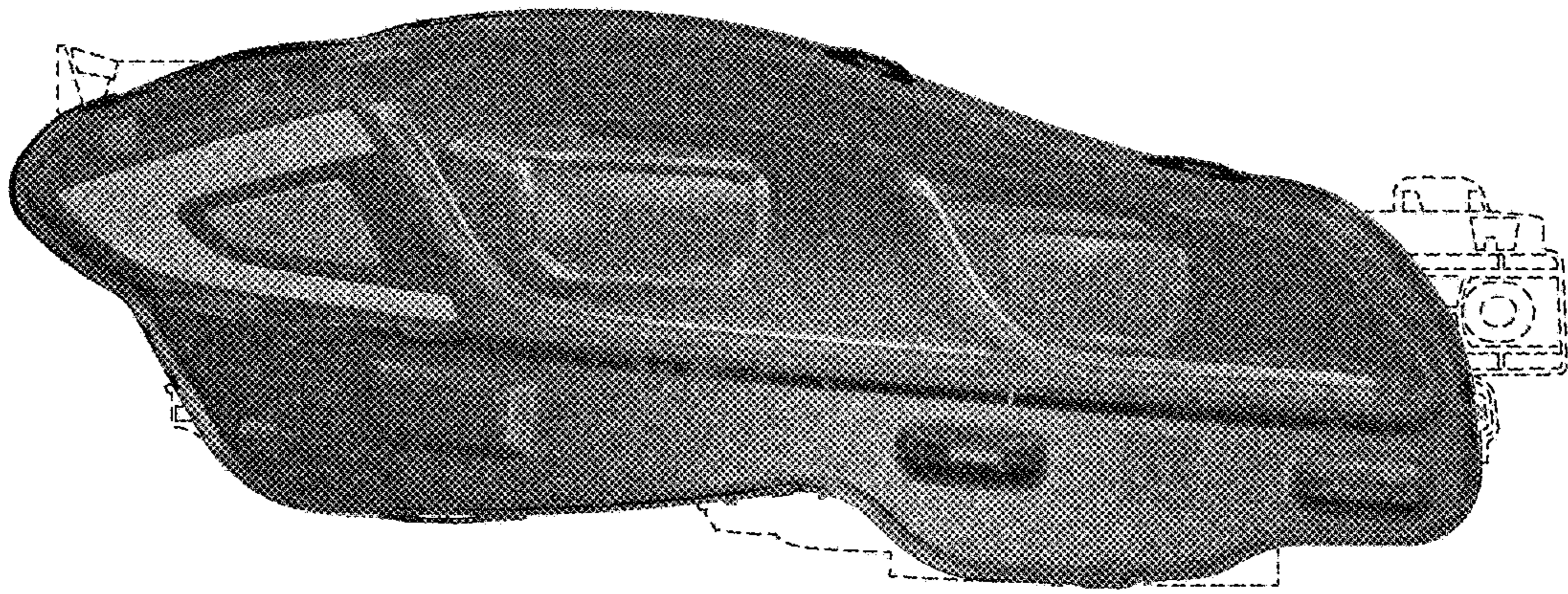

FIG. 1

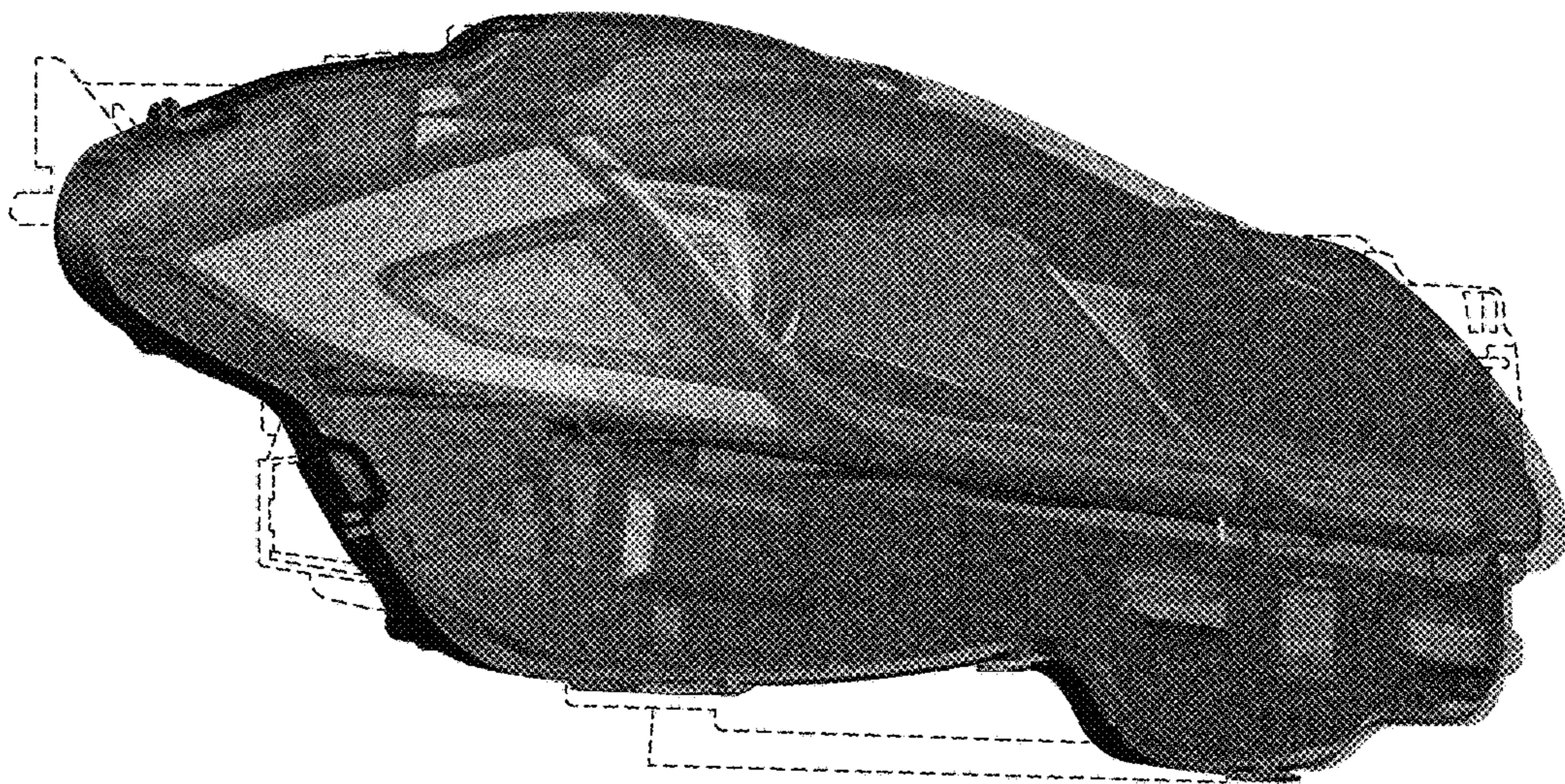

FIG. 2

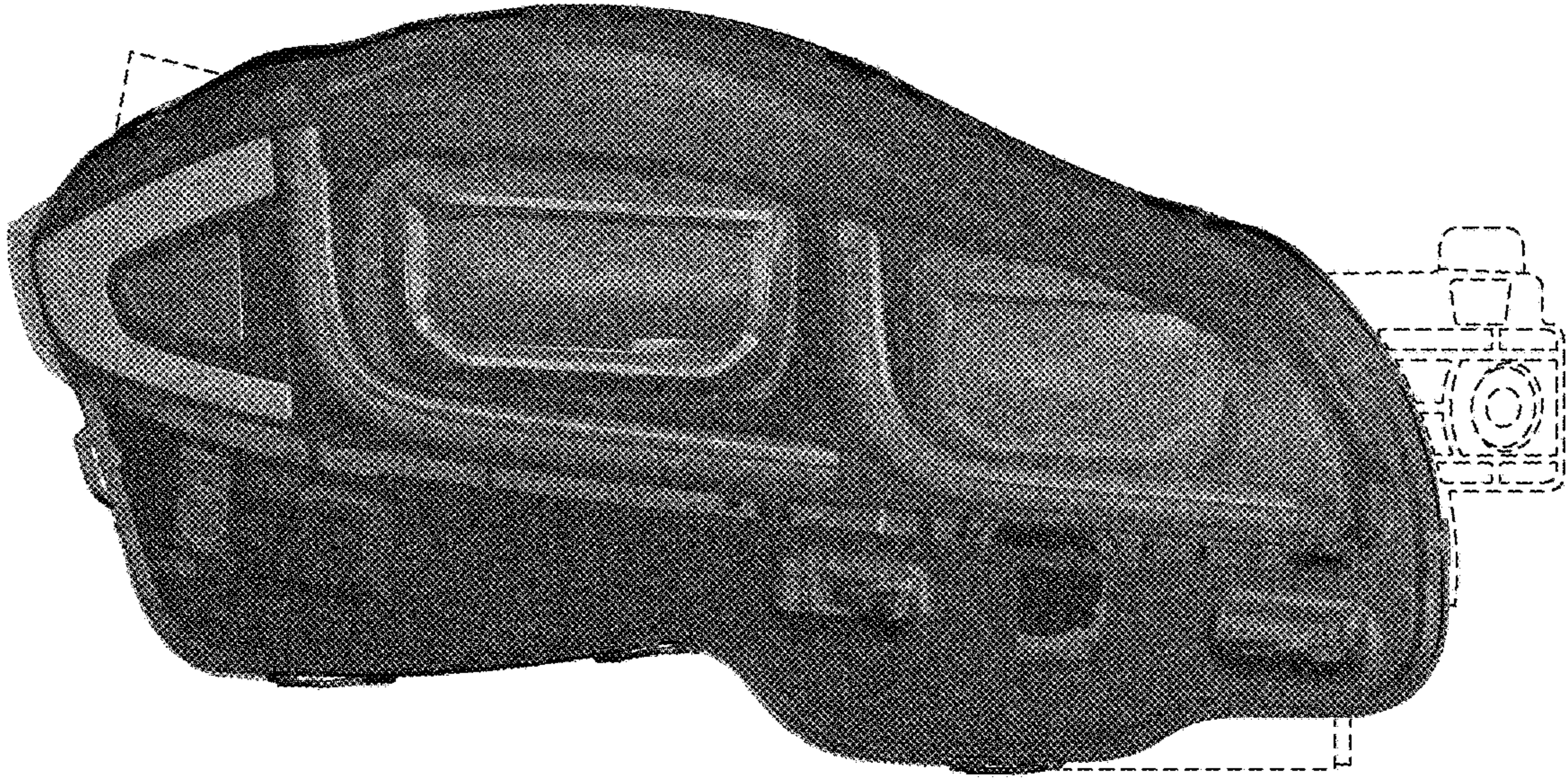

FIG. 3

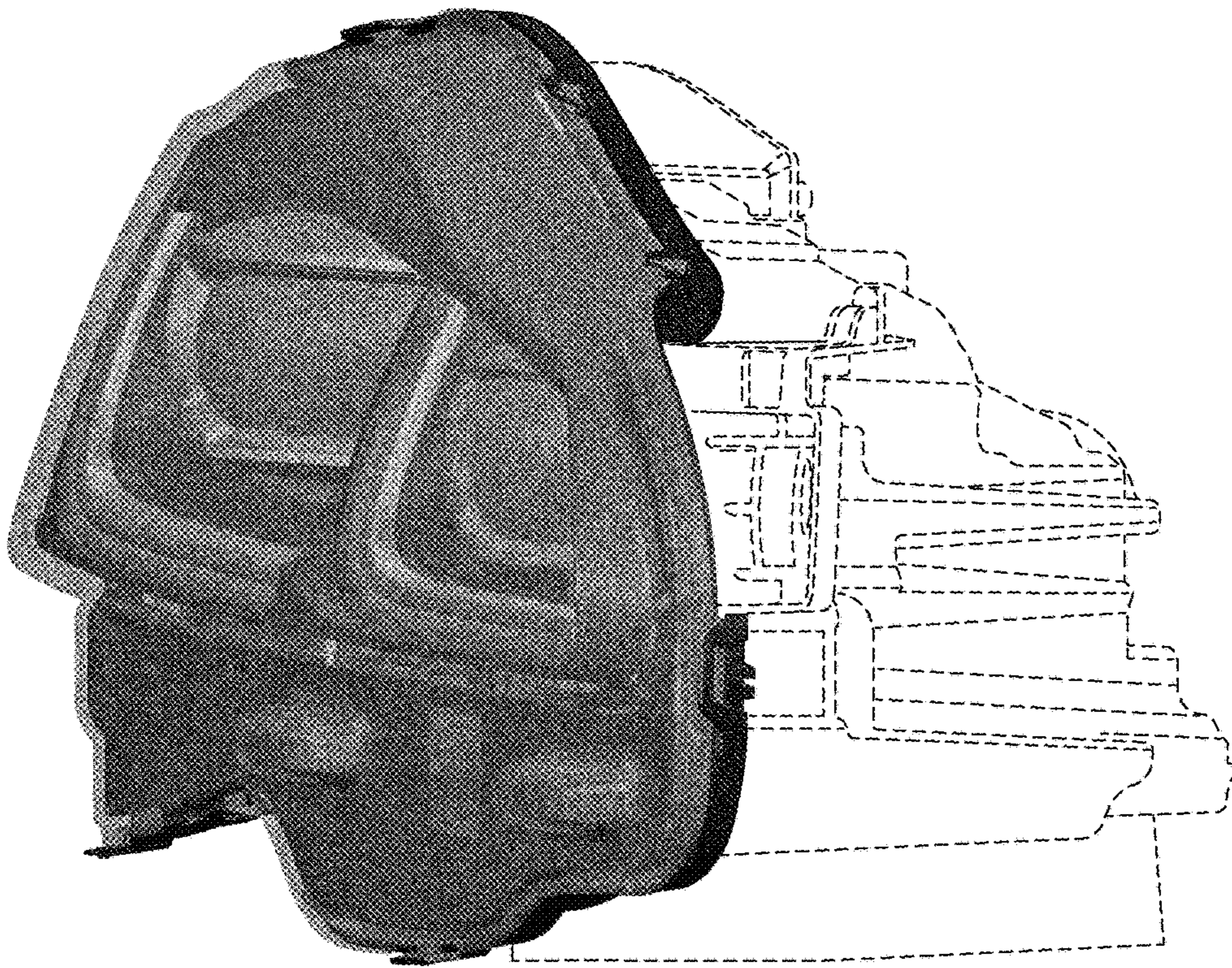

FIG. 4

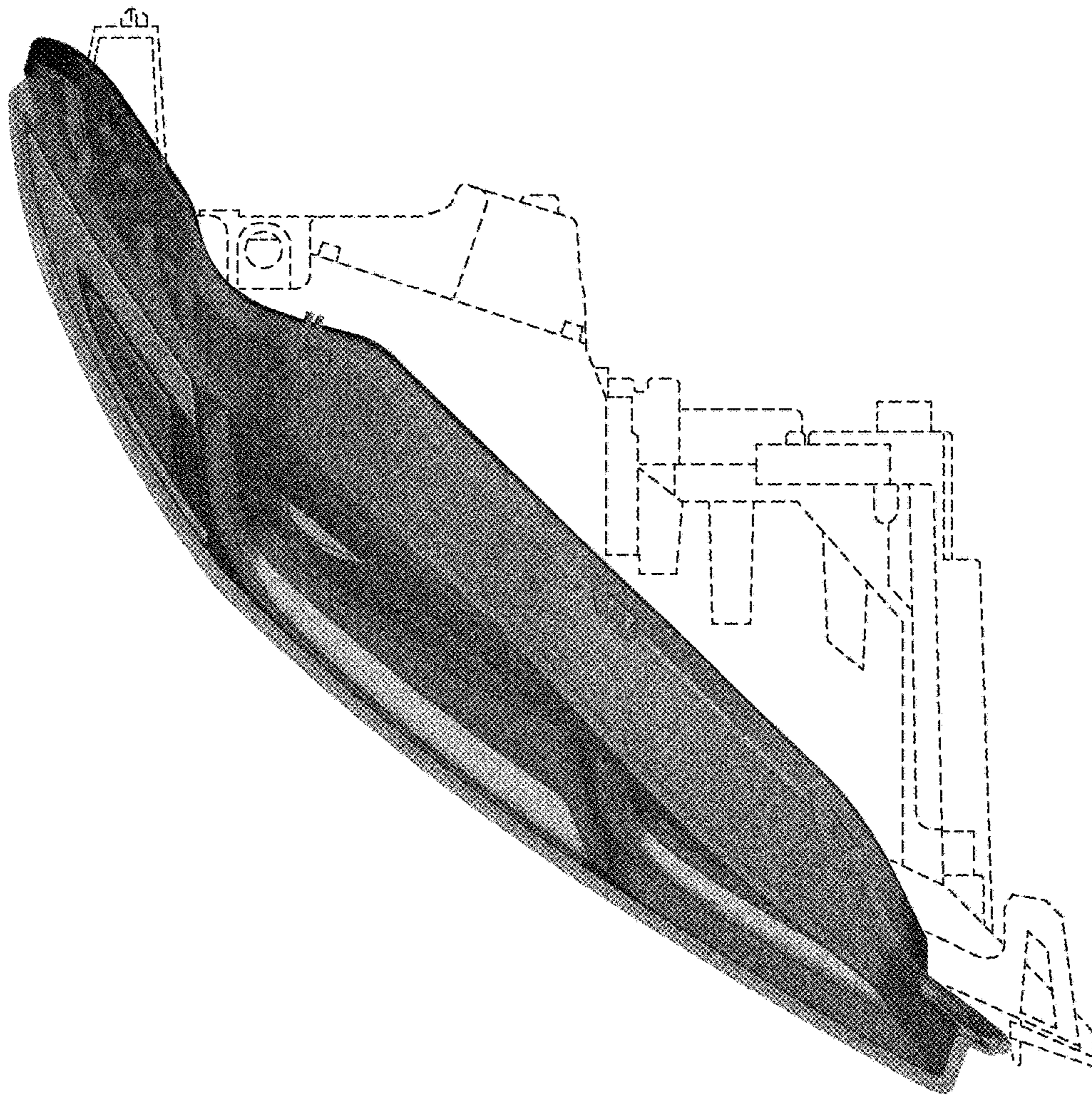

FIG. 5

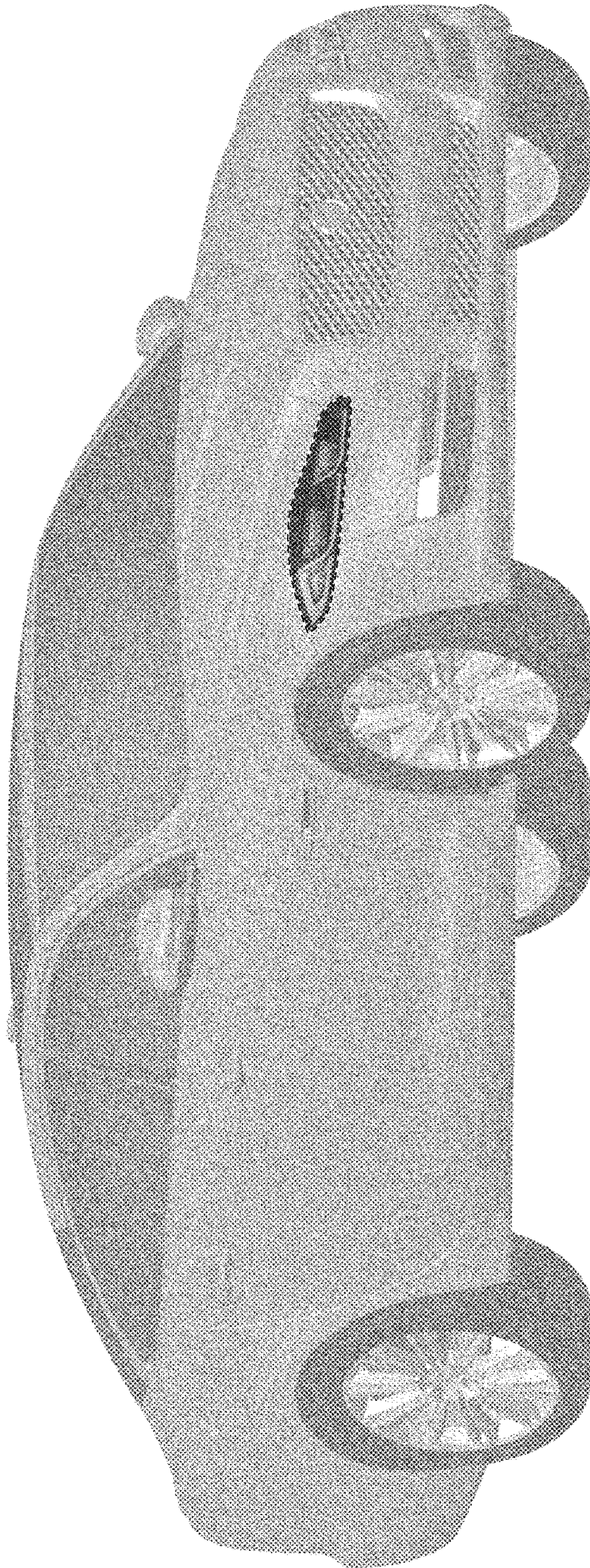

FIG. 6

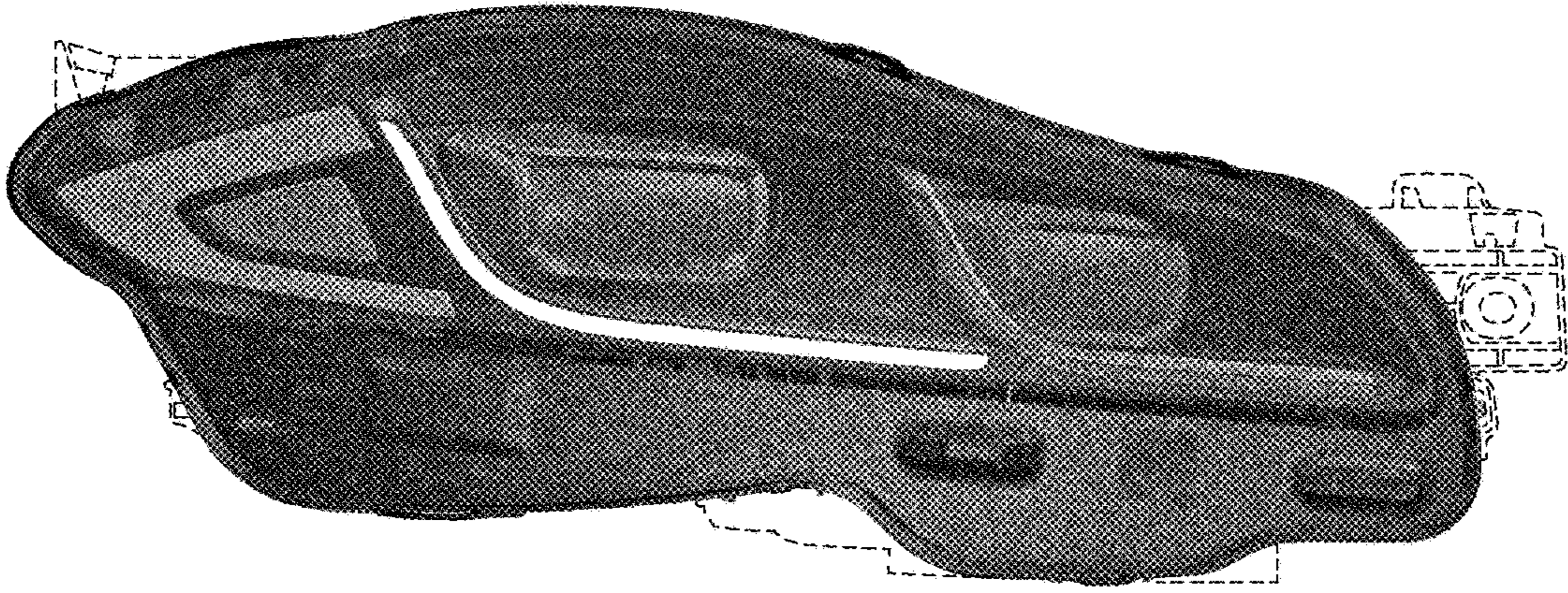

FIG. 7

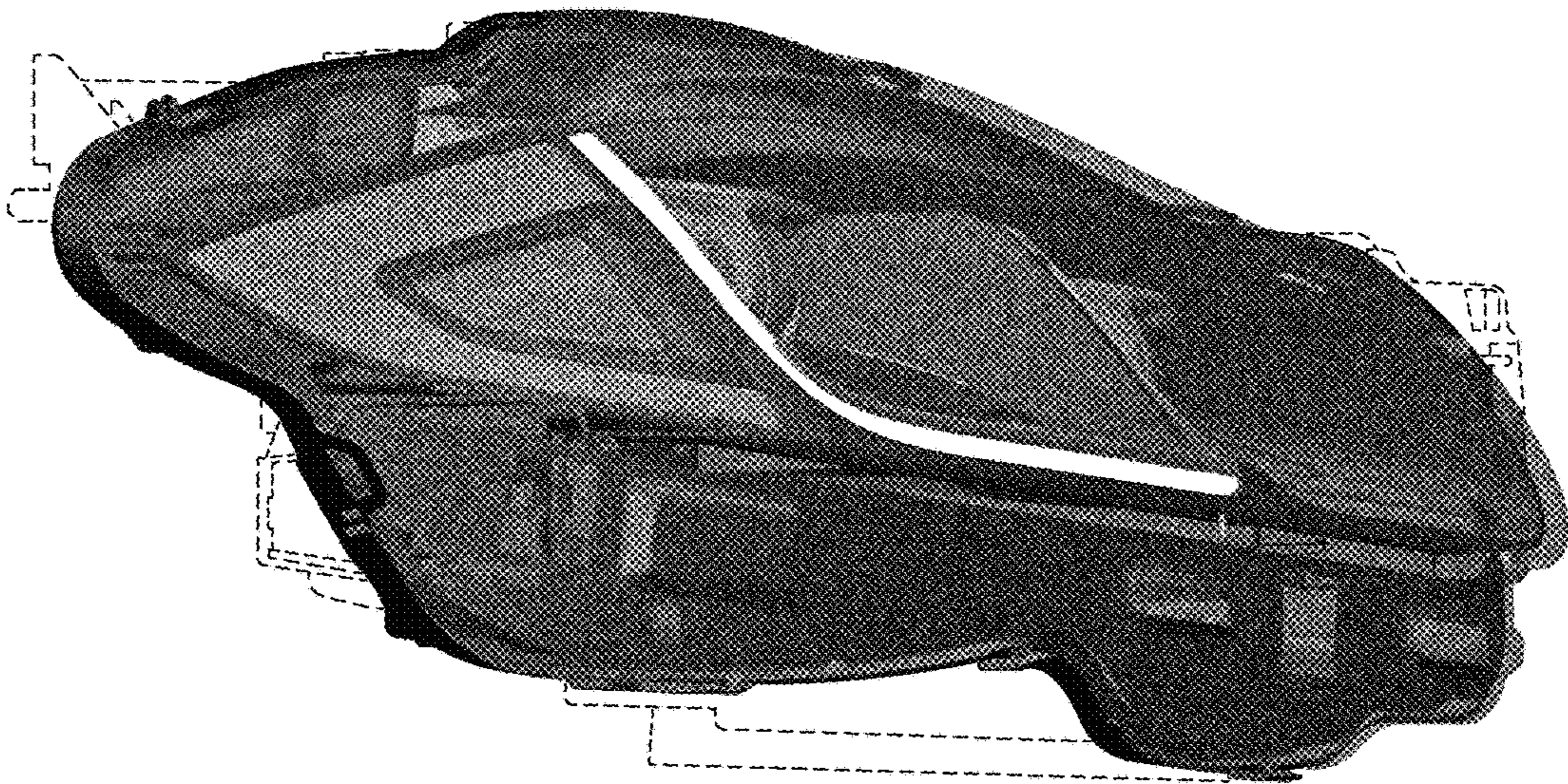

FIG. 8

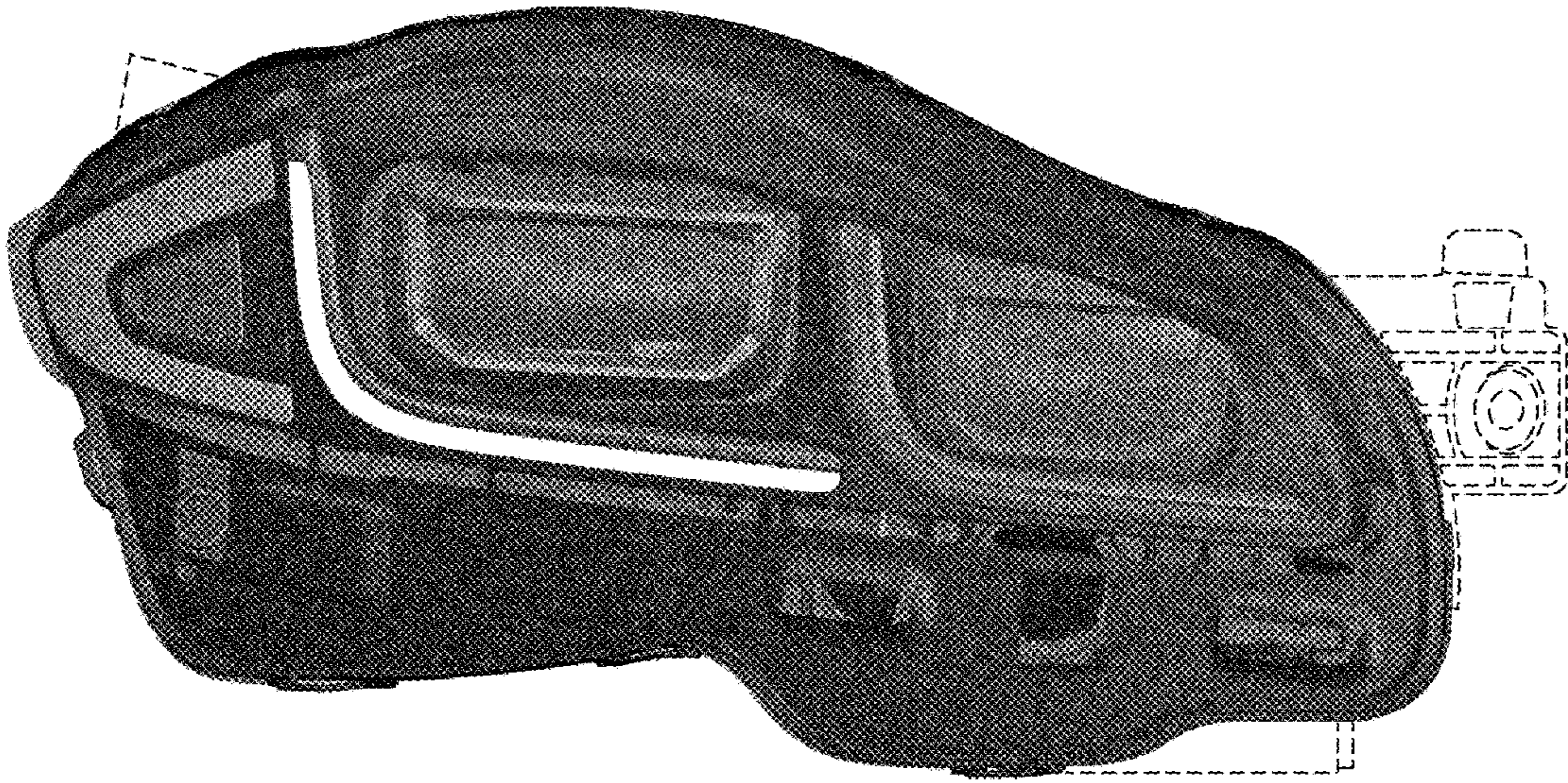

FIG. 9

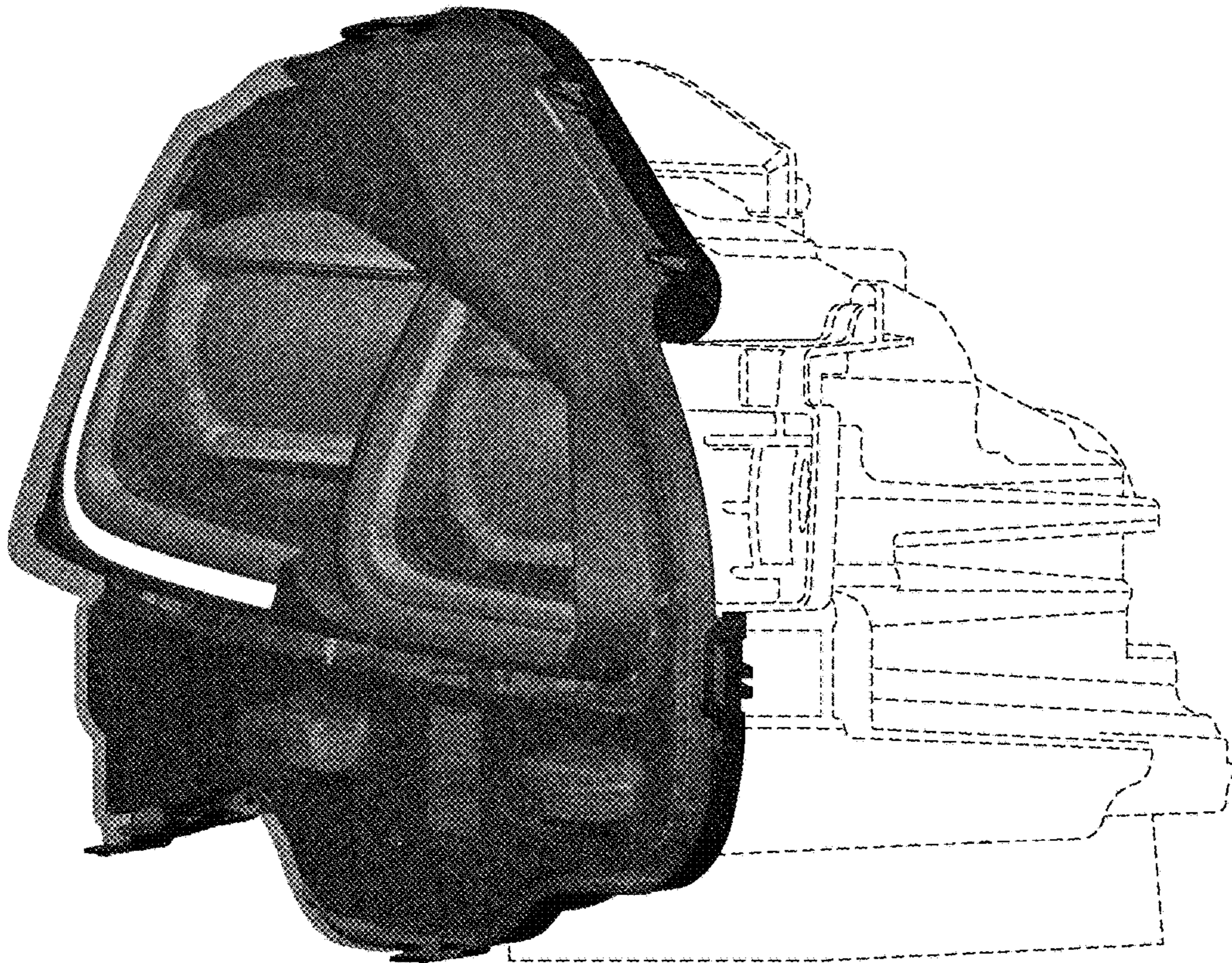

FIG. 10

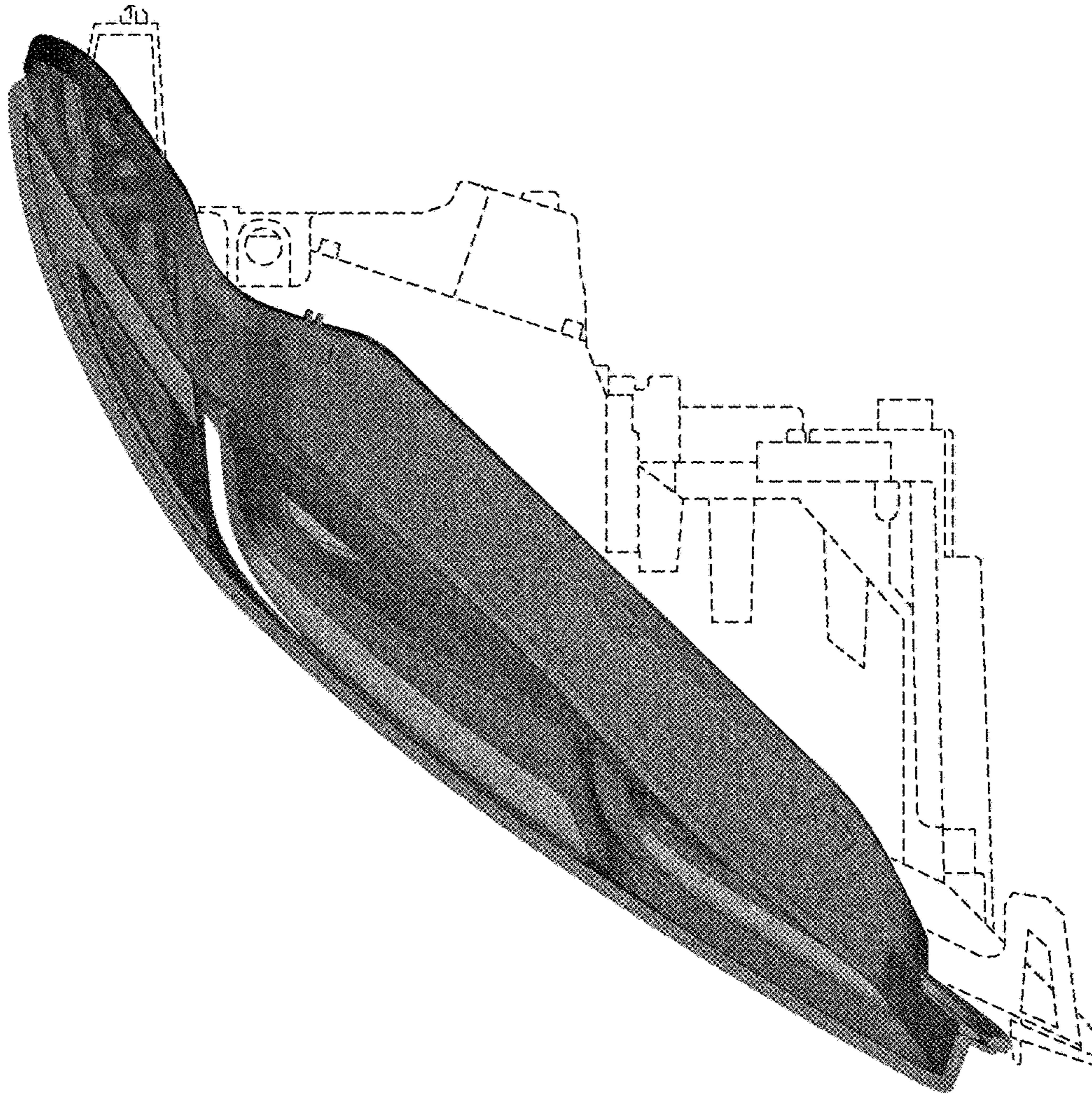

FIG. 11

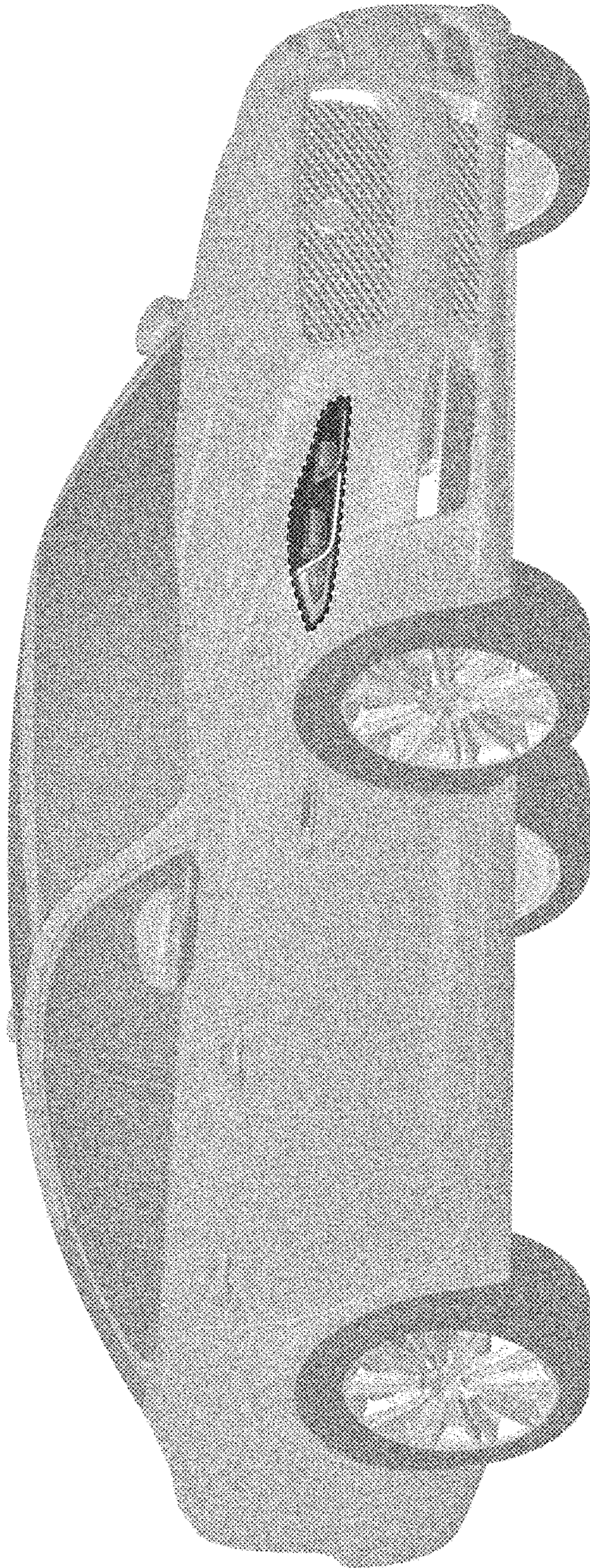

FIG. 12

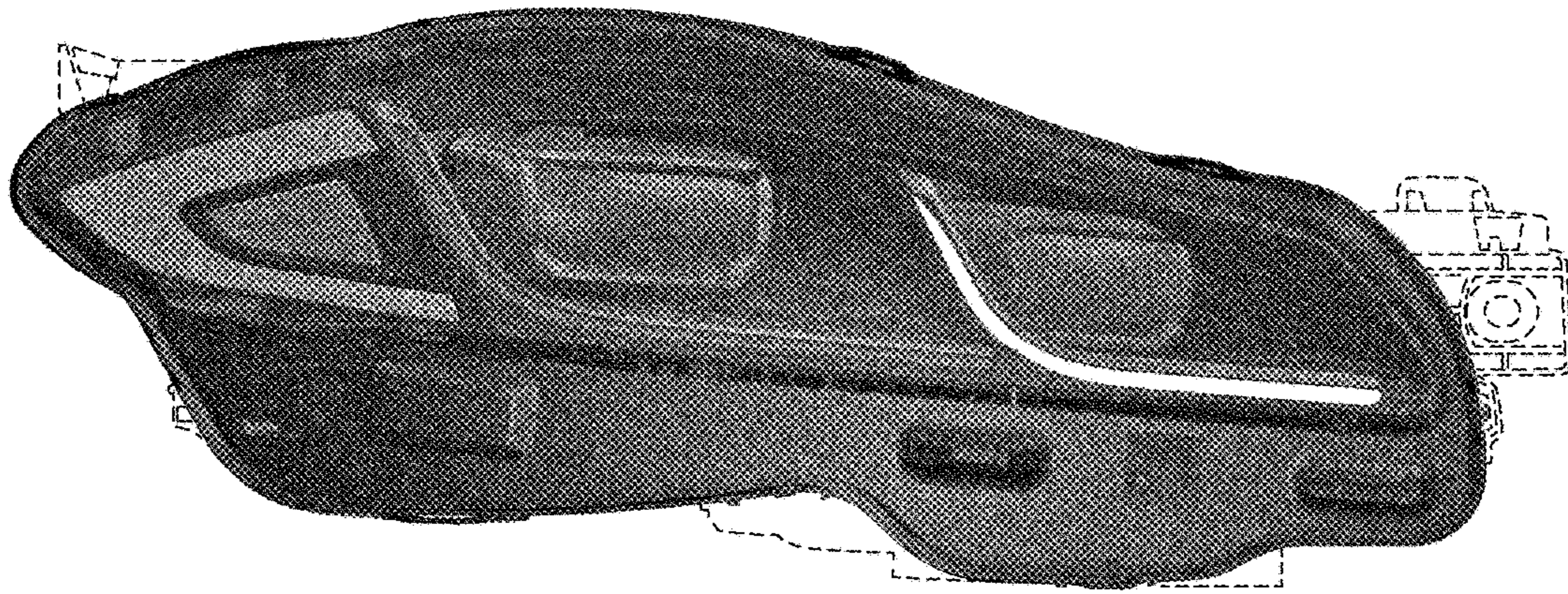

FIG. 13

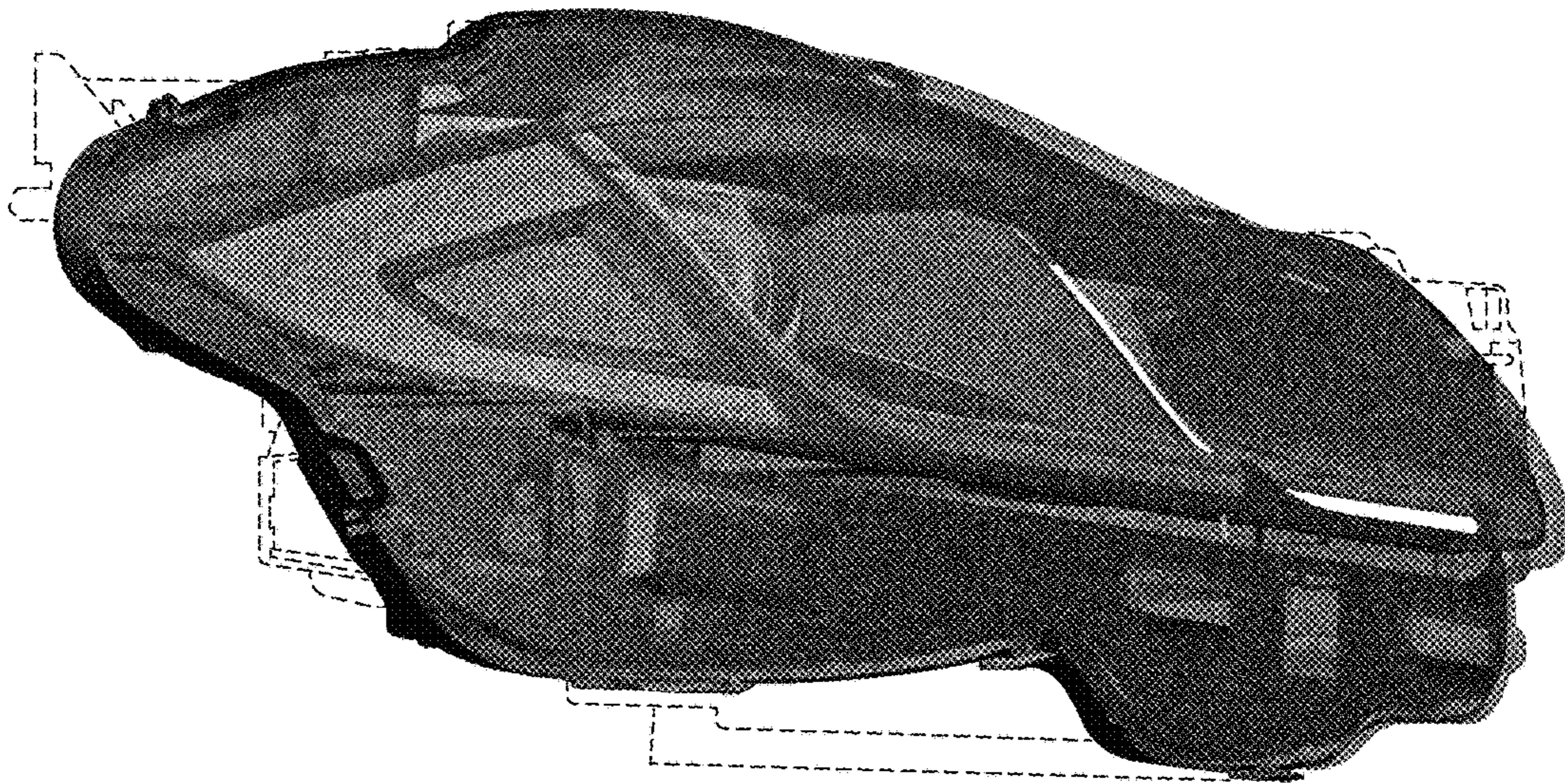

FIG. 14

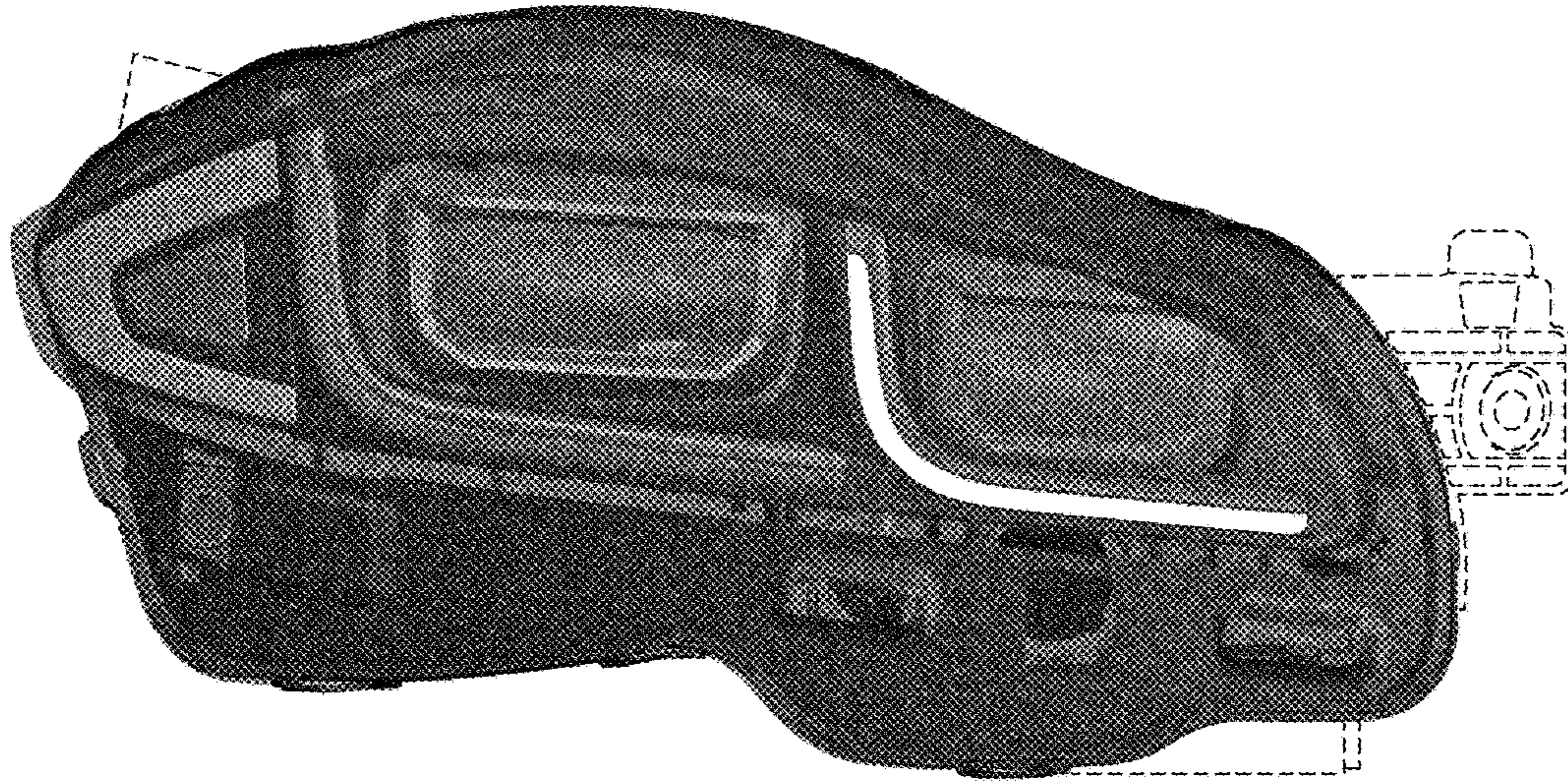

FIG. 15

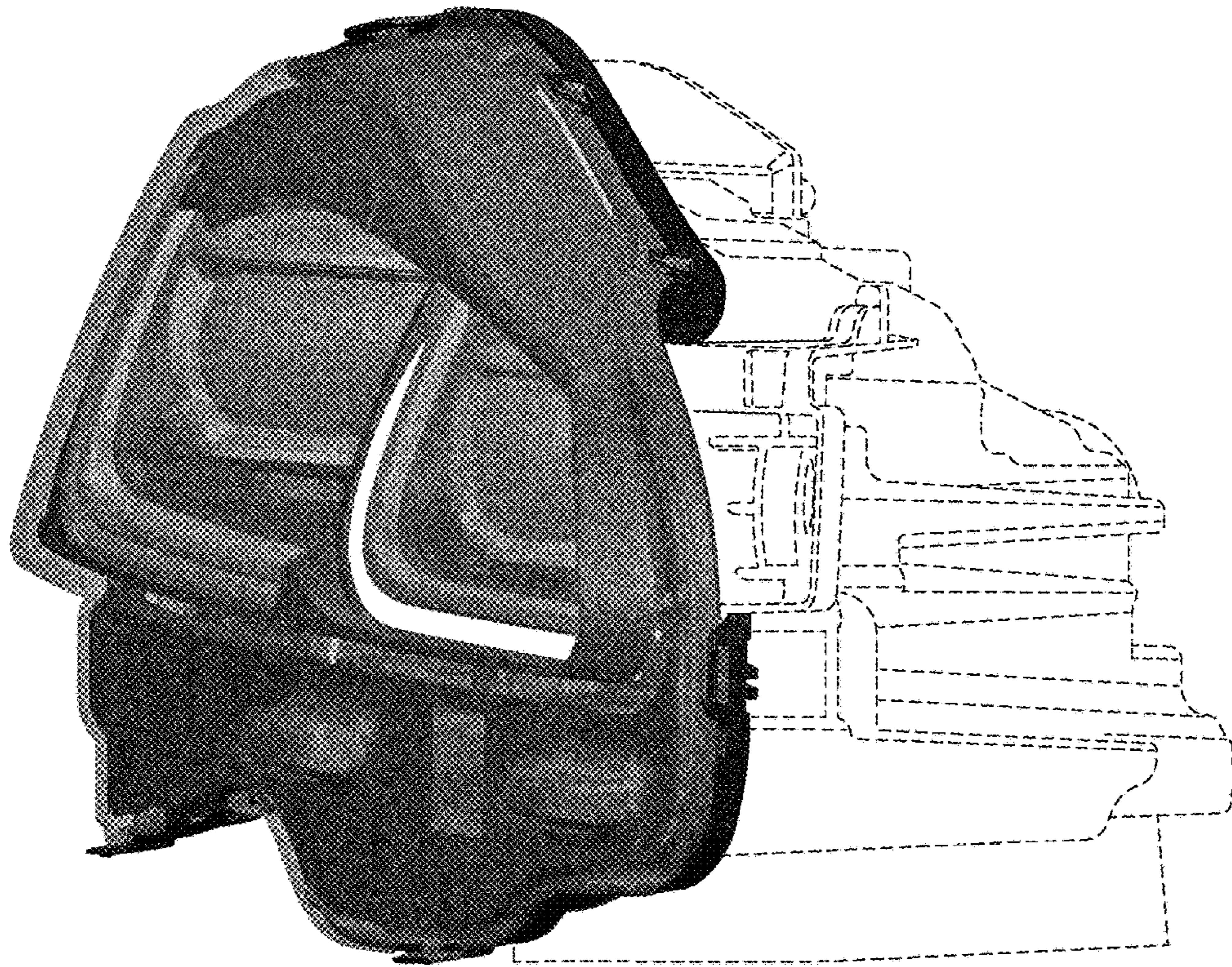

FIG. 16

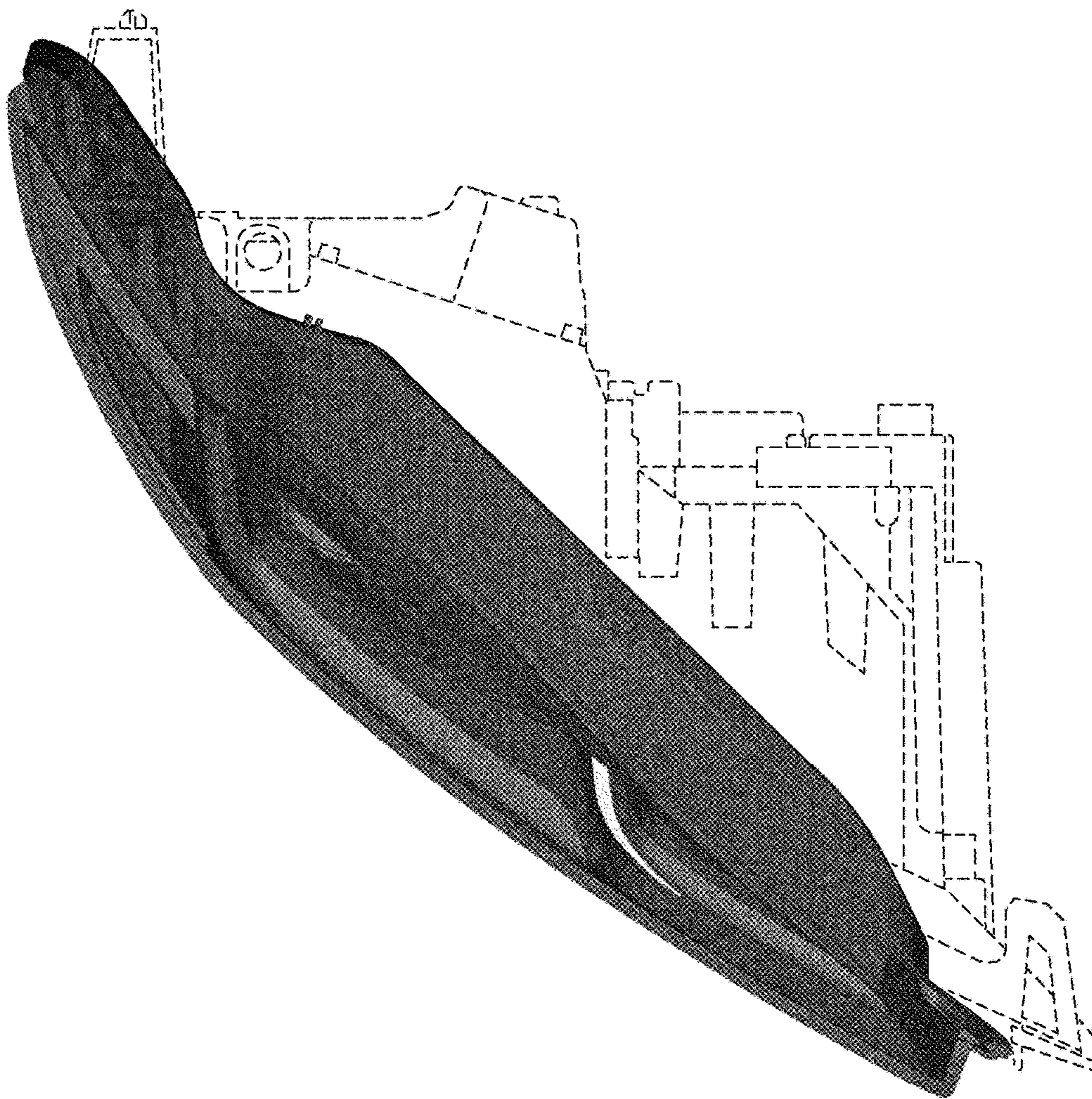

FIG. 17

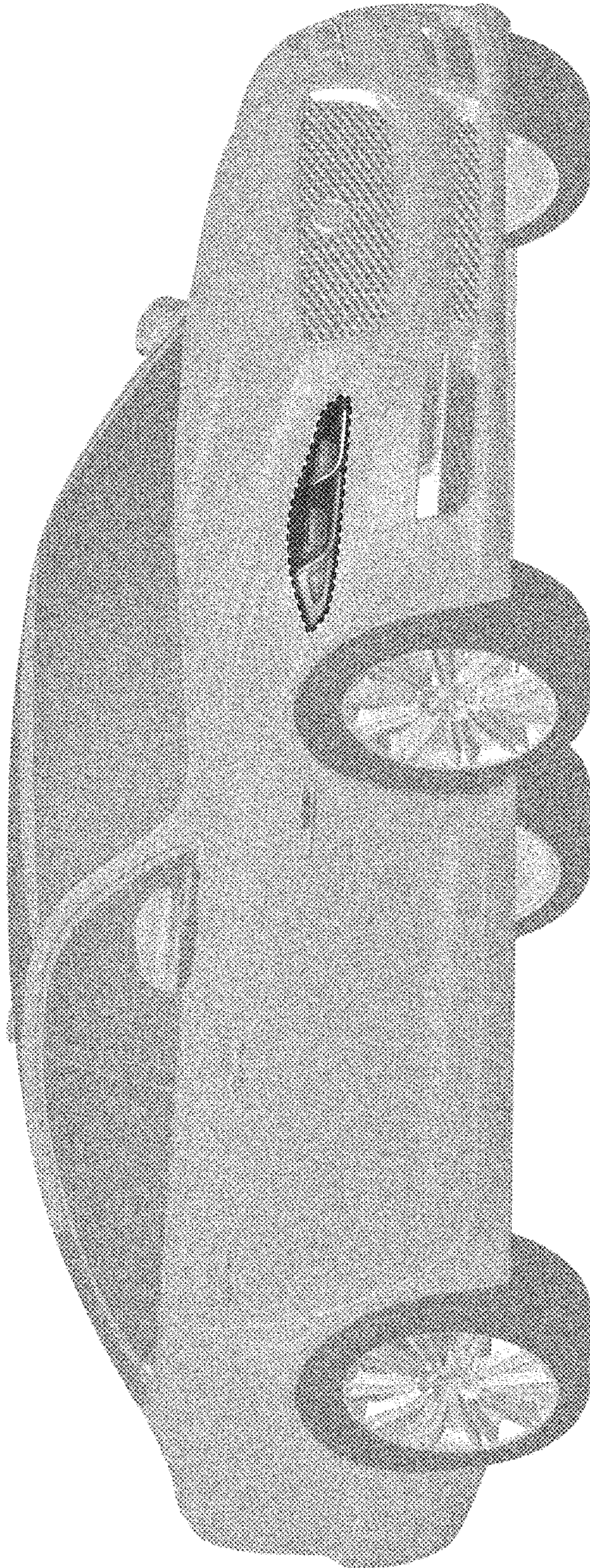

FIG. 18

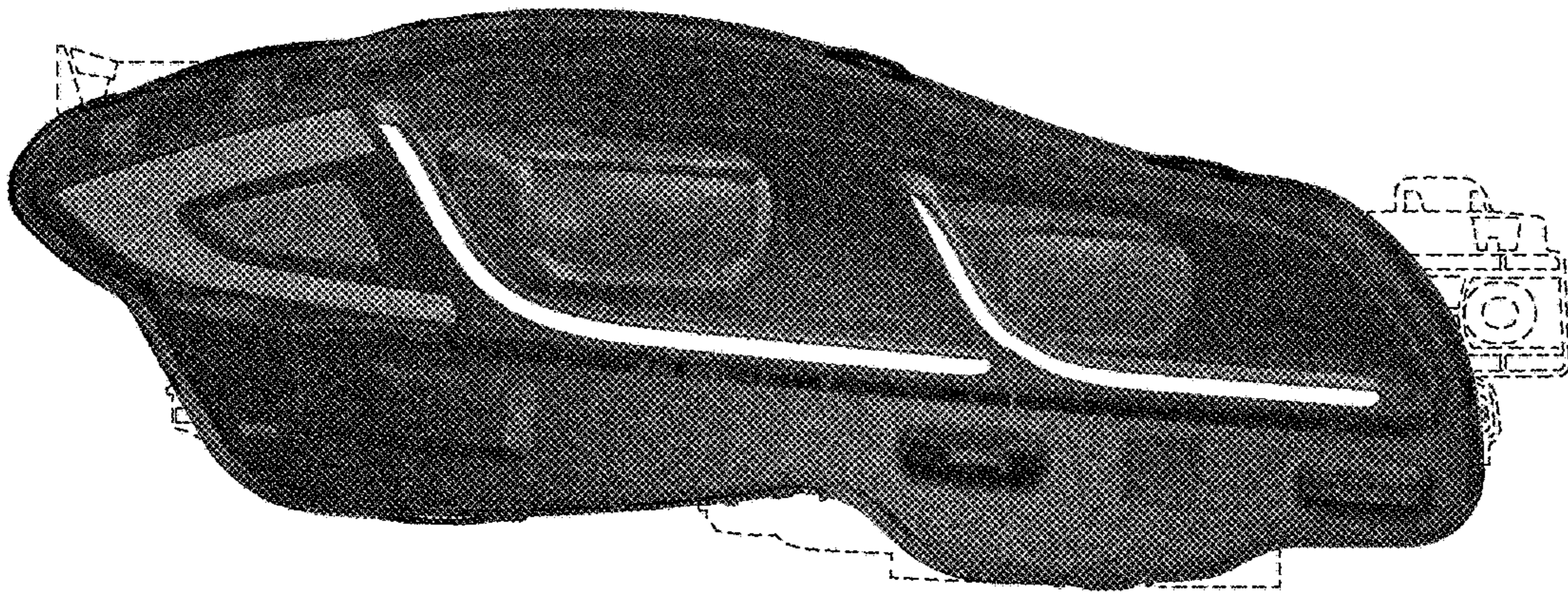

FIG. 19

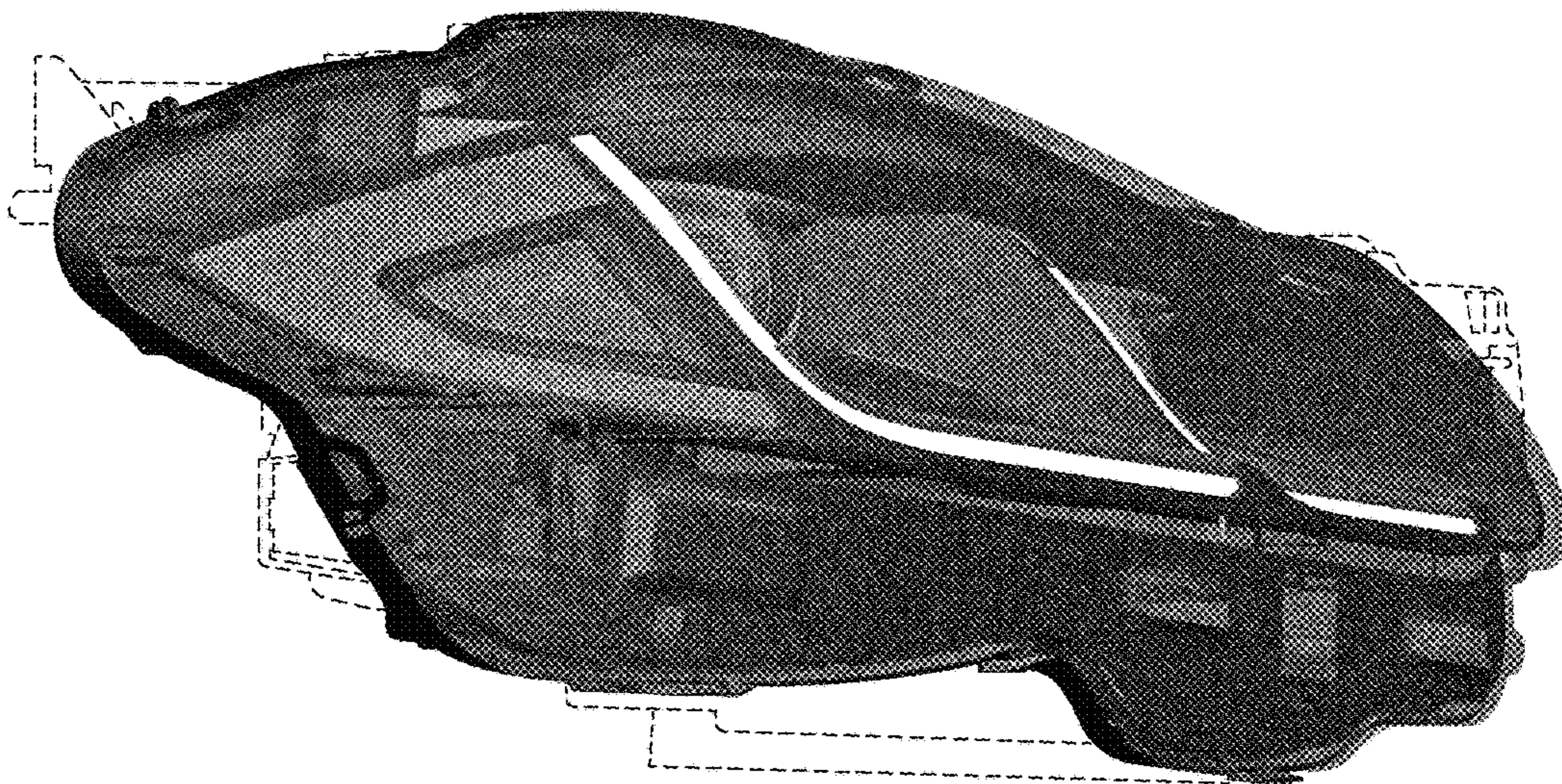

FIG. 20

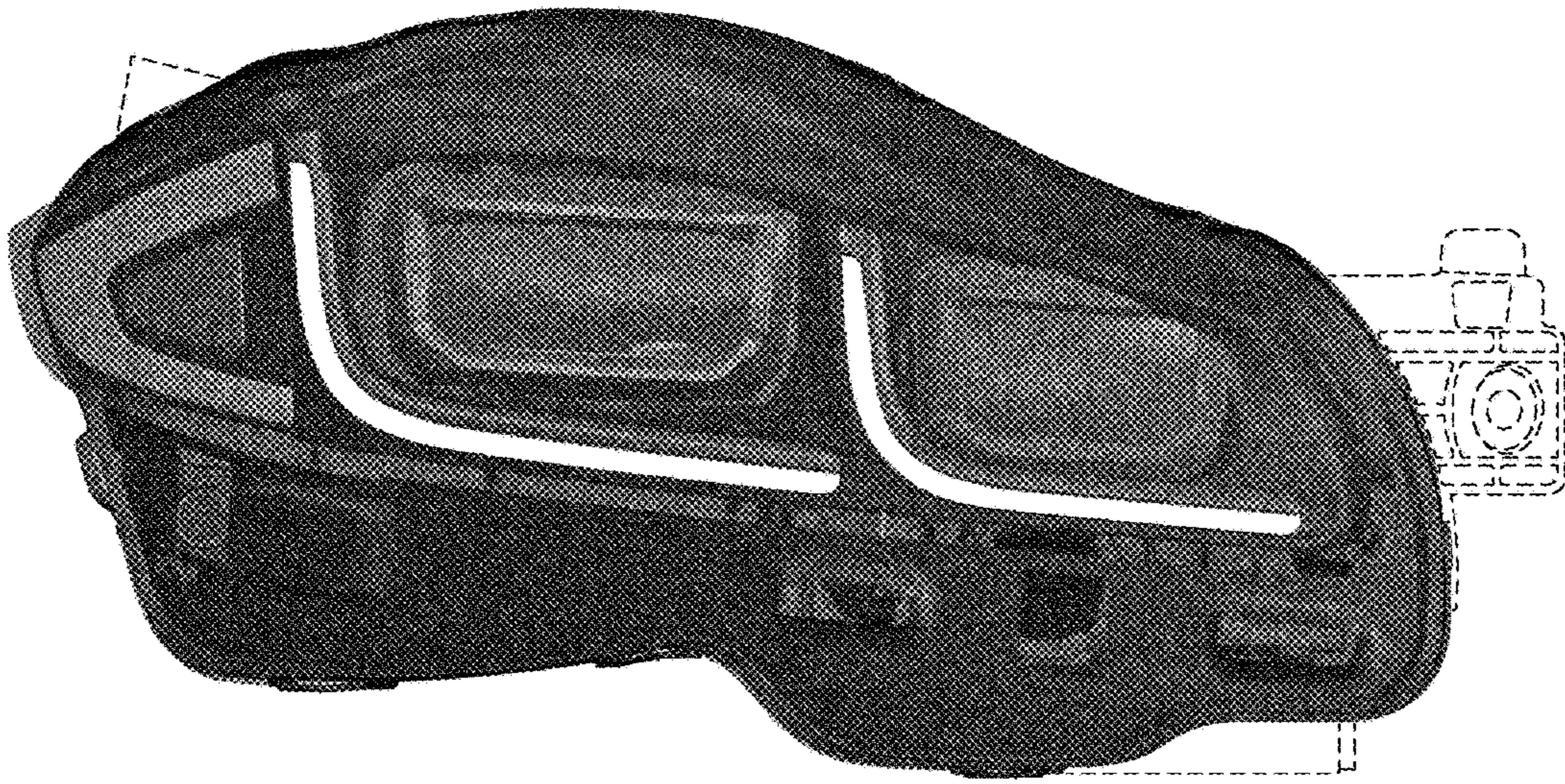

FIG. 21

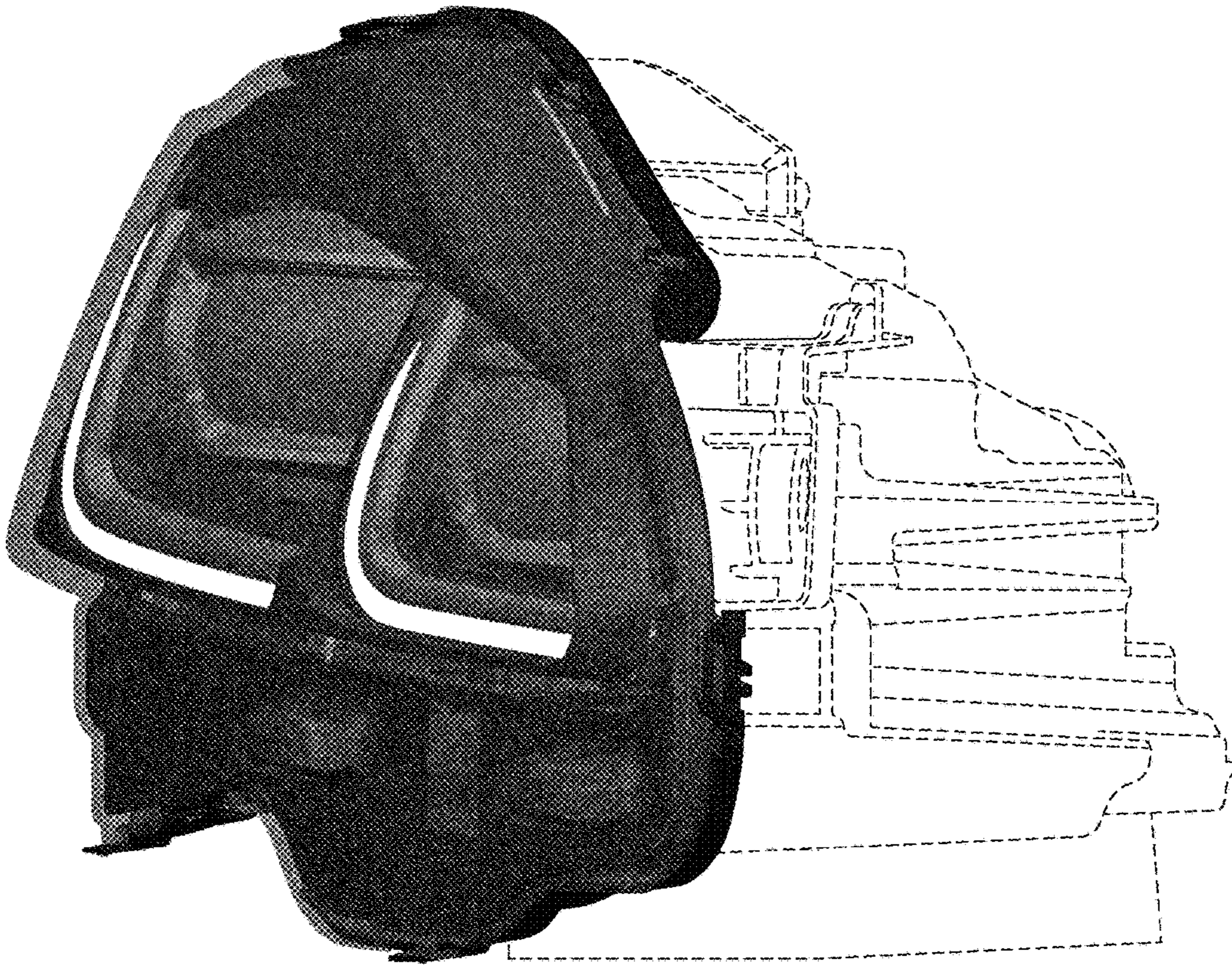

FIG. 22

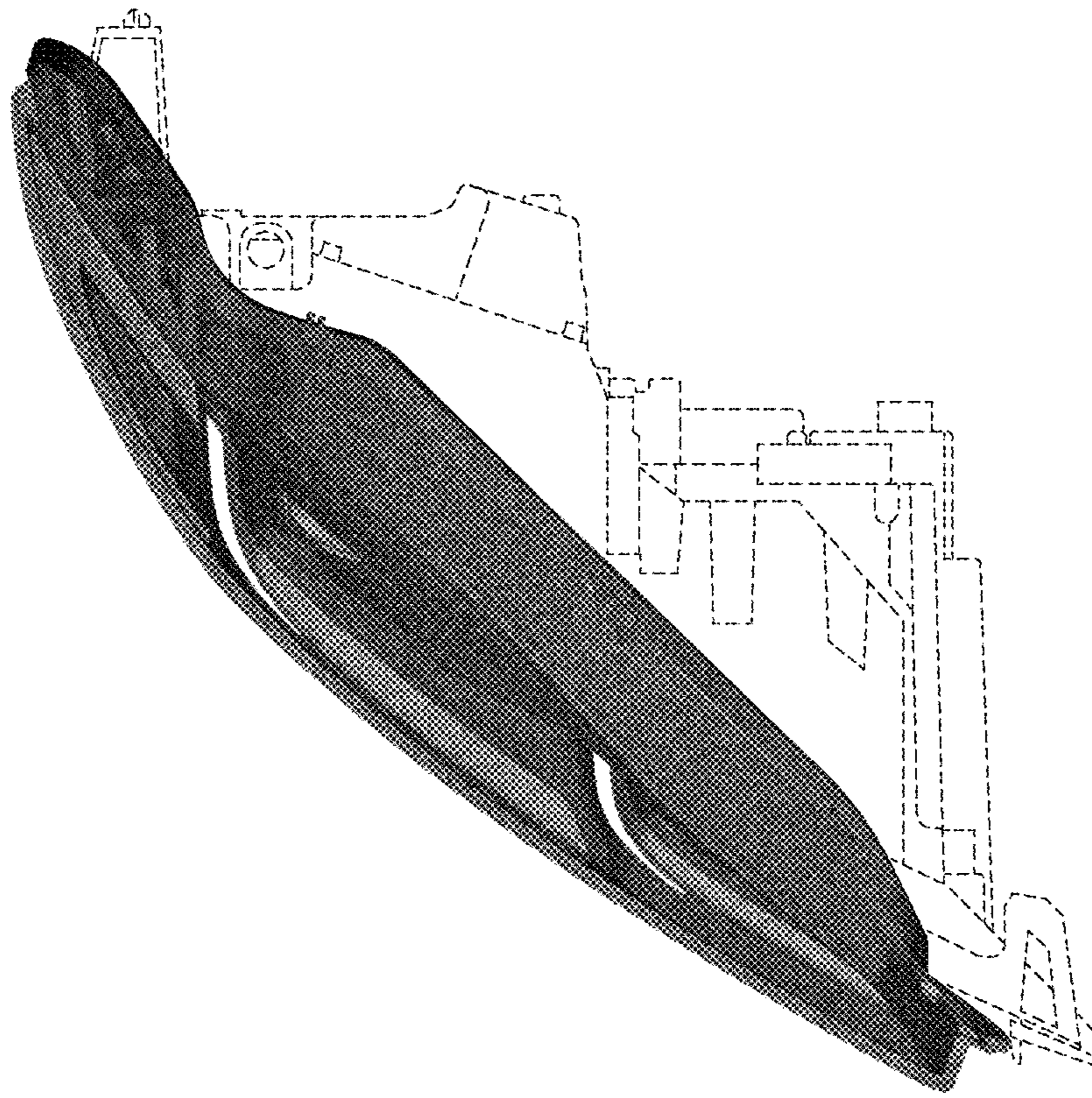

FIG. 23

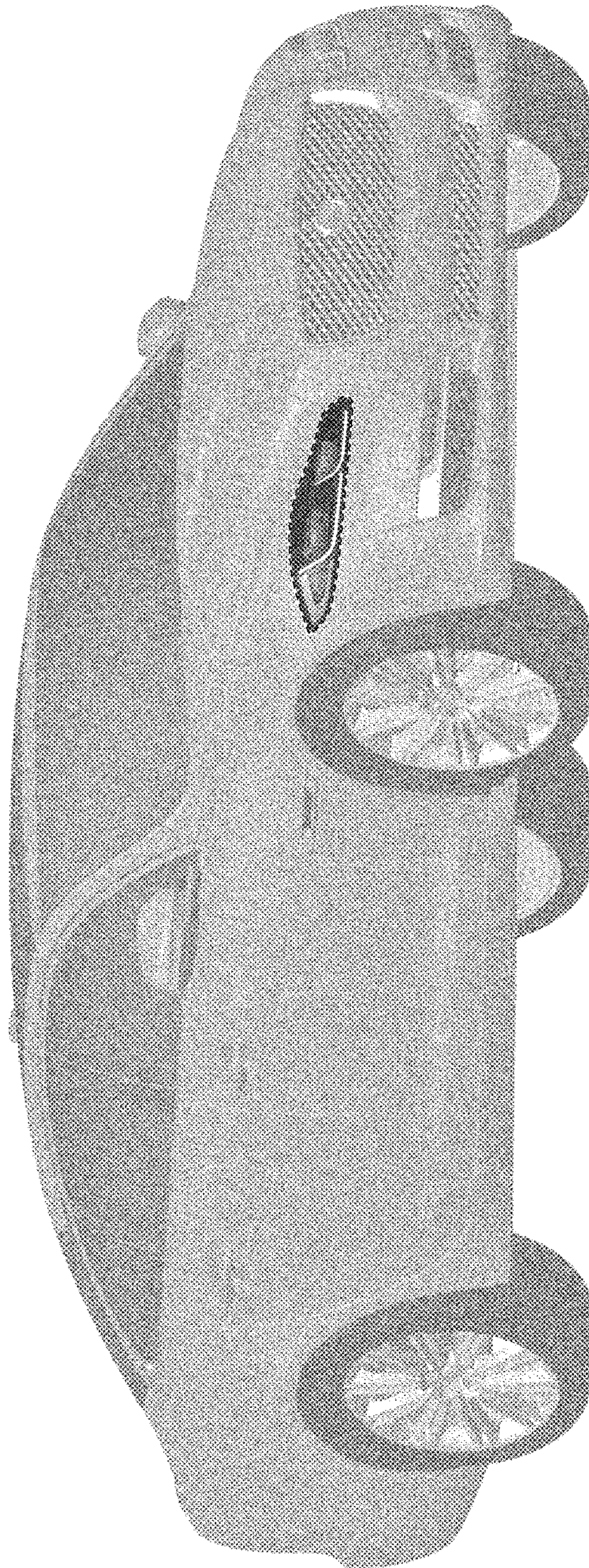

FIG. 24