



US00D797561S

(12) **United States Design Patent** (10) **Patent No.:** **US D797,561 S**
Eziquiel-Shriro (45) **Date of Patent:** **** Sep. 19, 2017**

(54) **BOTTLE**

- (71) Applicant: **Berlin Packaging, LLC**, Chicago, IL (US)
- (72) Inventor: **Jonathan Eziquiel-Shriro**, Chicago, IL (US)
- (73) Assignee: **Berlin Packaging, LLC**, Chicago, IL (US)
- (**) Term: **15 Years**
- (21) Appl. No.: **29/563,826**
- (22) Filed: **May 9, 2016**
- (51) **LOC (10) Cl.** **09-01**
- (52) **U.S. Cl.**
USPC **D9/528; D9/533; D9/563; D9/565; D9/575**

- (58) **Field of Classification Search**
USPC D9/651, 658, 523-524, 528, 530-535, D9/548, 549-550, 574, 575, 520, 522, D9/526, 527, 553, 555, 556, 557, D9/563-570, 742; 215/381-385; 220/660, 669, 679, 752; D23/211.1
CPC B65D 23/00; B65D 23/10; B65D 1/00; B65D 1/02; B65D 21/00; B65D 21/02; B65D 21/0201; B65D 21/0209; B65D 21/0233; B65D 21/0234; B65D 21/0237; B65D 1/10; B65D 1/40; B65D 1/42; B65D 11/04; B65D 2501/0081; B65D 2101/0053; B65D 1/0223
See application file for complete search history.

(56) **References Cited**

U.S. PATENT DOCUMENTS

D435,451 S	*	12/2000	Giugiaro	D9/528
D459,993 S	*	7/2002	Clarke	D9/528
D549,580 S	*	8/2007	Bates	D9/528
D553,991 S	*	10/2007	Wachsberg	D9/528
D576,046 S	*	9/2008	Cardinal	D9/531
D595,586 S	*	7/2009	Kissinger	D9/528

(Continued)

OTHER PUBLICATIONS

Jonathan Eziquiel-Shriro, posted at coroflot.com, posting date not given, © 2017 Core77, Inc., [online], [site visited Jun. 6, 2017]. Available from Internet, <URL: <http://www.coroflot.com/Zeke/profile>>.*

Primary Examiner — Anhdao Doan

Assistant Examiner — Mary Malley

(74) *Attorney, Agent, or Firm* — Adam K. Sacharoff; Much Shelist, PC

(57) **CLAIM**

The ornamental design for a bottle, as shown and described.

DESCRIPTION

FIG. 1 is a rear right side perspective view showing the new design for a bottle;
 FIG. 2 is a rear left side perspective view thereof;
 FIG. 3 is a front right side perspective view thereof;
 FIG. 4 is a front left side perspective view thereof;
 FIG. 5 is another rear right side perspective view, taken from beneath the bottle;
 FIG. 6 is another rear left side perspective view, taken from beneath the bottle;
 FIG. 7 is another front right side perspective view, taken from beneath the bottle;
 FIG. 8 is another left side perspective view, taken from beneath the bottle;
 FIG. 9 is a front view thereof;
 FIG. 10 is a rear view thereof;
 FIG. 11 is a left side view thereof;
 FIG. 12 is a right side view thereof;
 FIG. 13 is a top plan view thereof; and,
 FIG. 14 is a bottom plan view thereof.
 The broken lines show portions of the bottle that form no part of the claimed design.

1 Claim, 14 Drawing Sheets

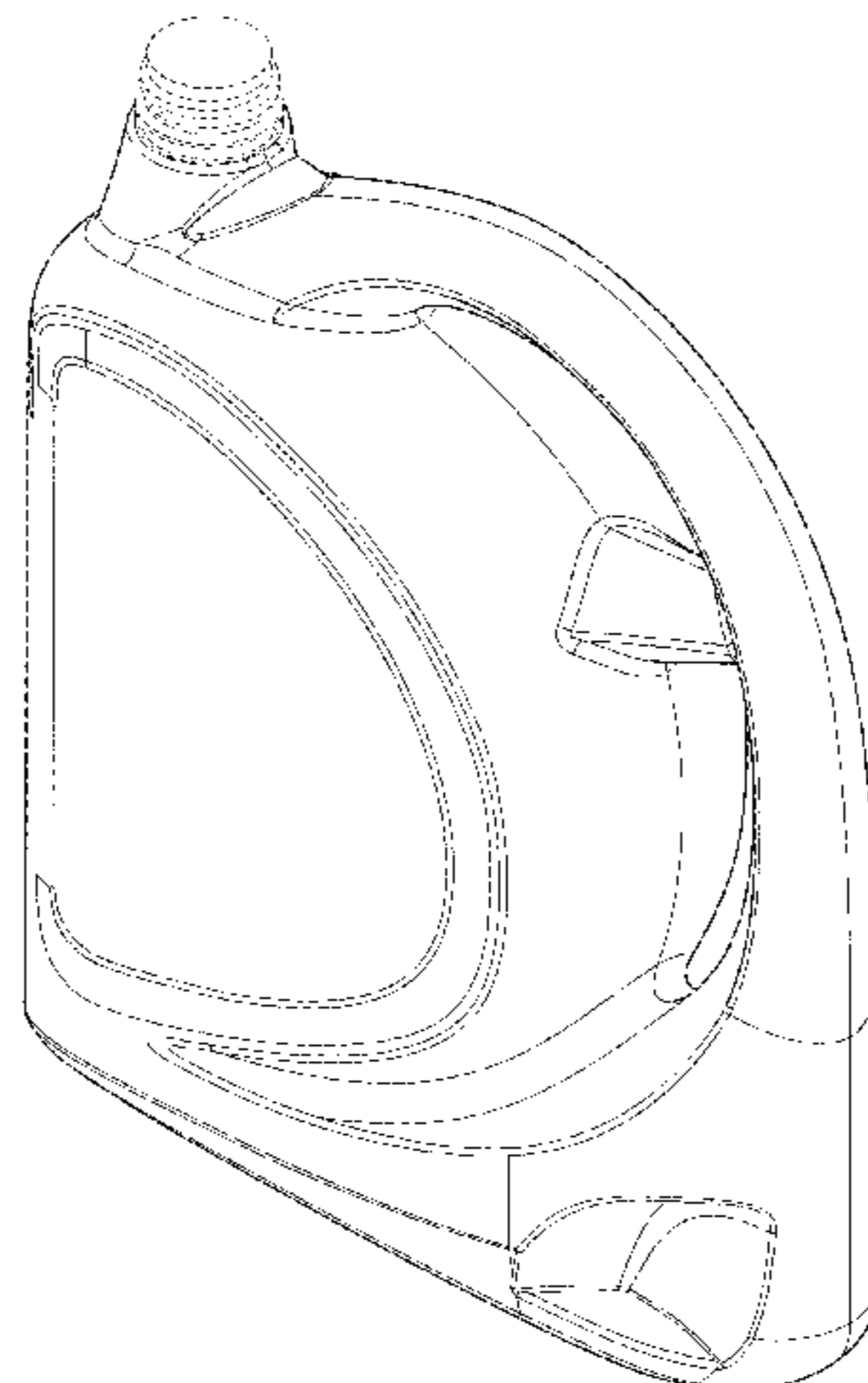

(56)

References Cited

U.S. PATENT DOCUMENTS

D609,577 S *	2/2010	Mayers	D9/528
D609,578 S *	2/2010	Mayers	D9/528
D656,401 S *	3/2012	Hickey	D9/527
D685,642 S *	7/2013	Leslie	D9/528
D726,015 S *	4/2015	Jasso Gomez	D9/531
D726,017 S *	4/2015	Janney	D9/531
D744,840 S *	12/2015	Hawry	D9/529
D747,968 S *	1/2016	Martin	D9/453
D766,723 S *	9/2016	Hawry	D9/523

* cited by examiner

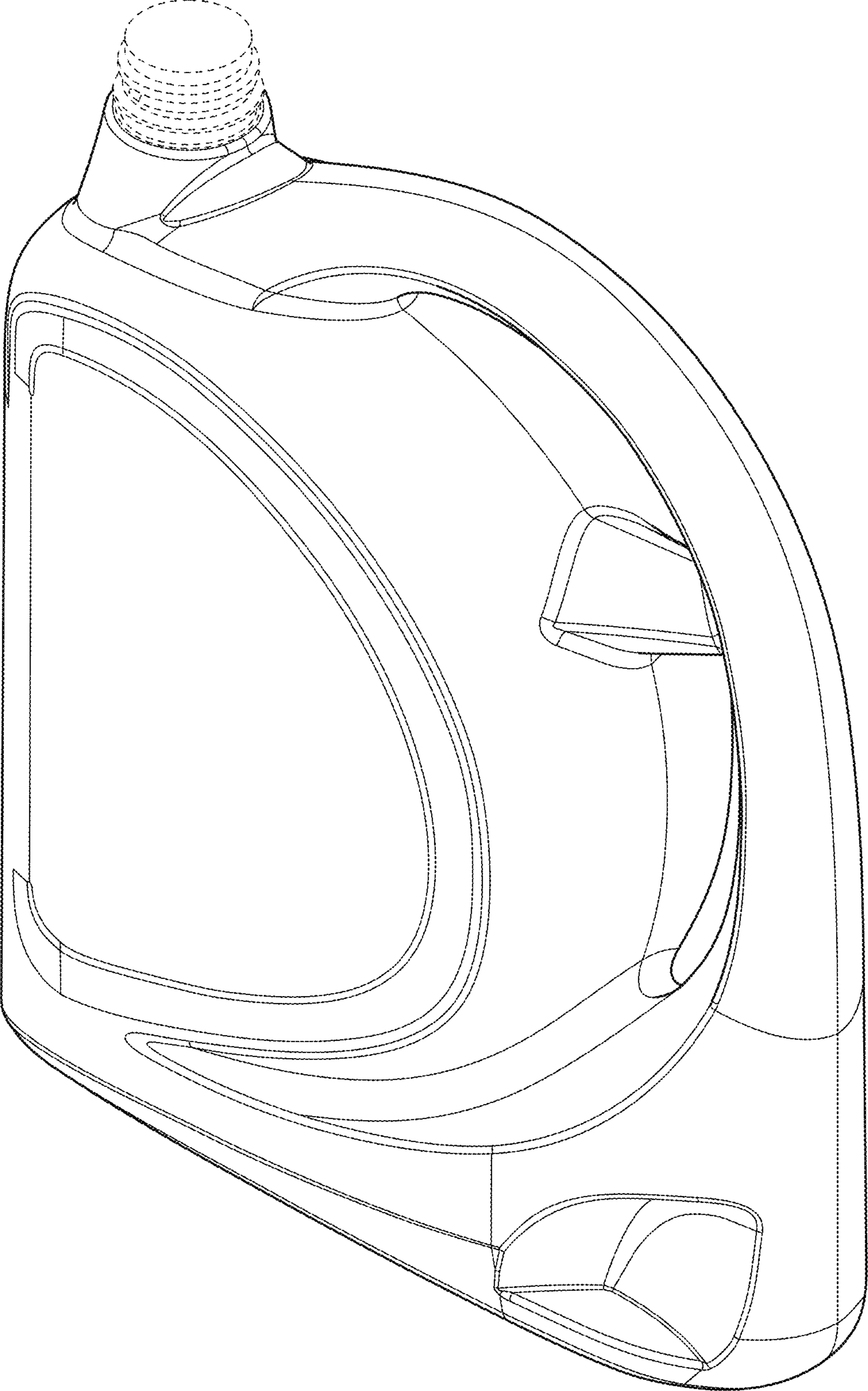

FIG. 1

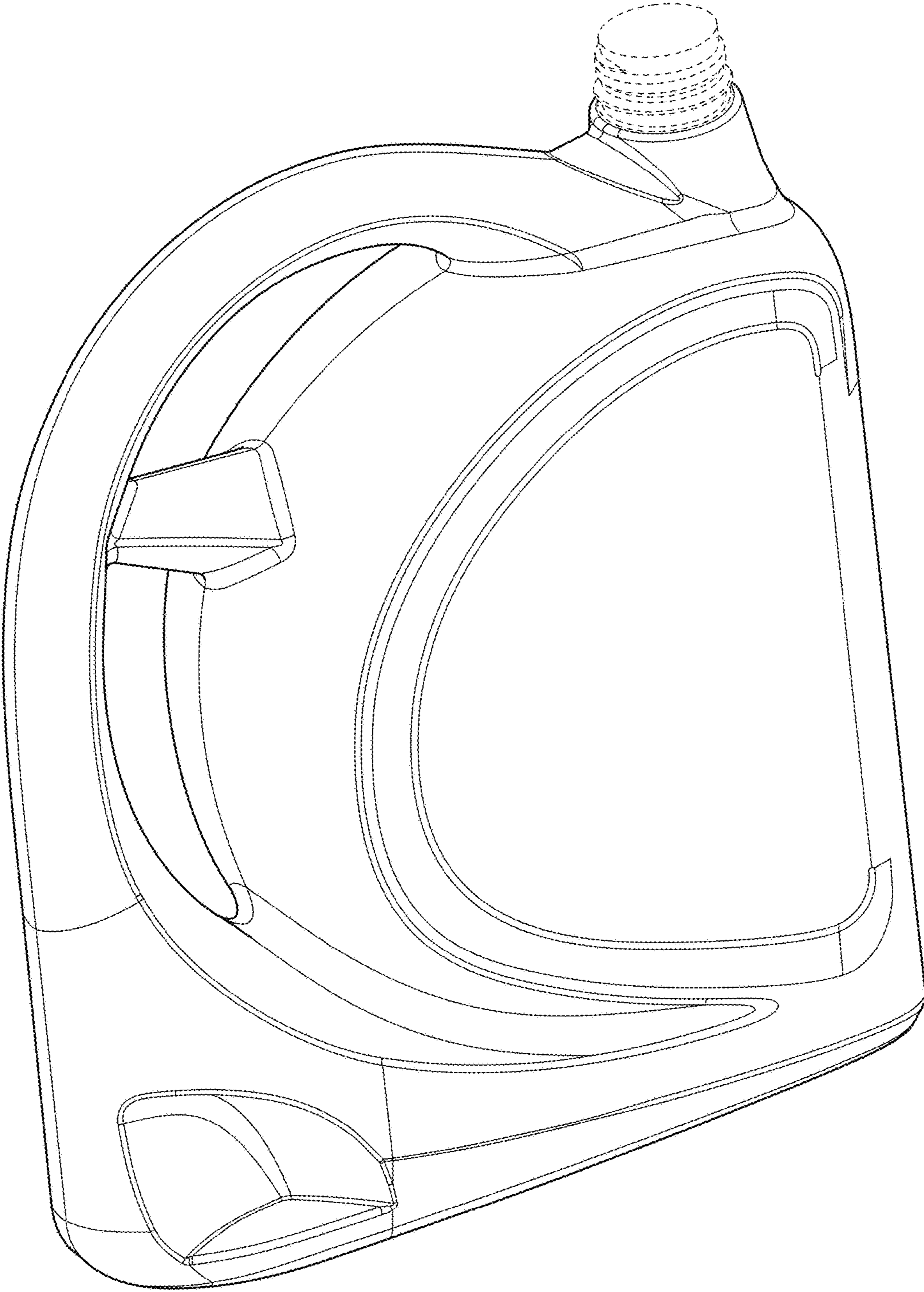

FIG. 2

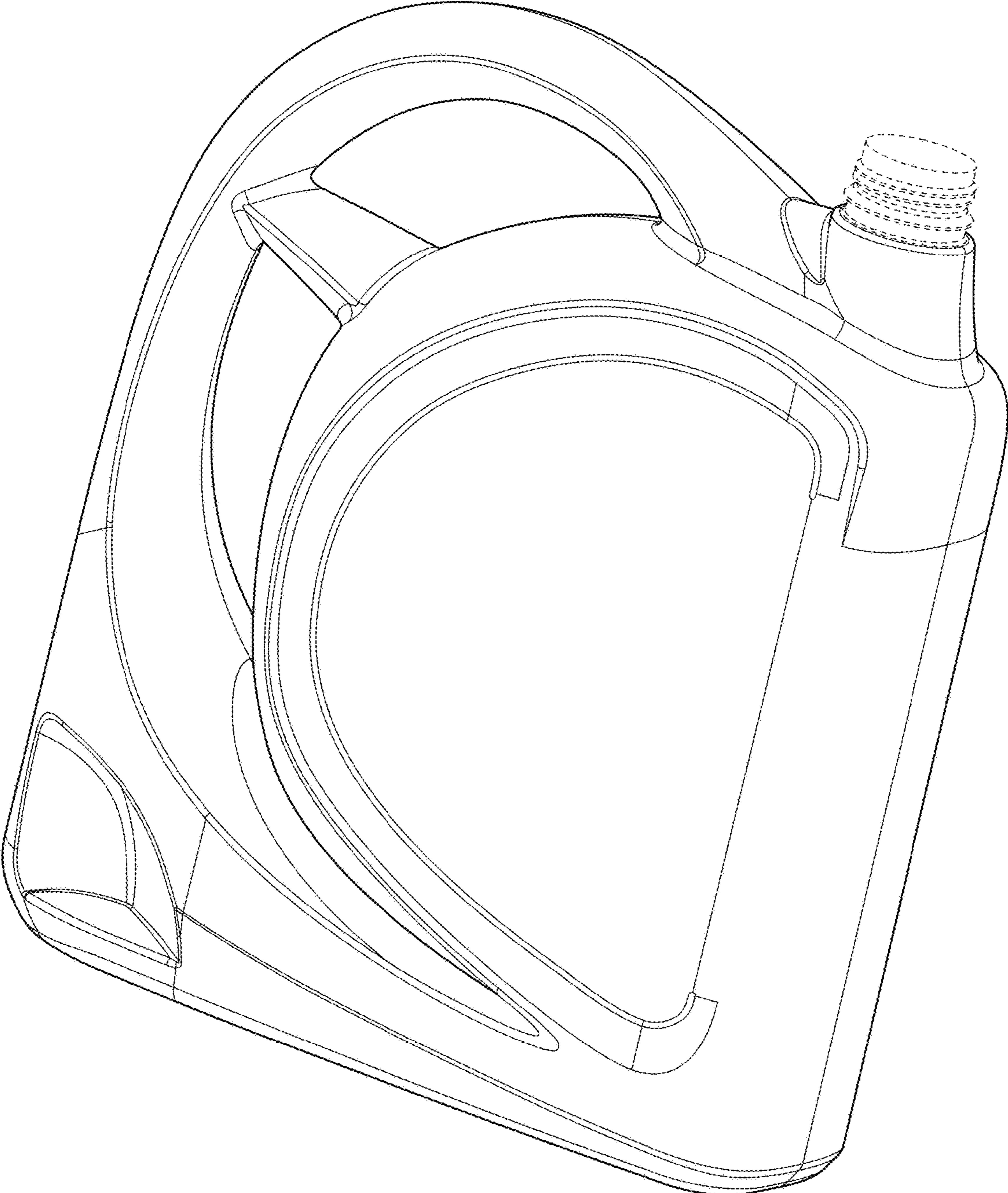

FIG. 3

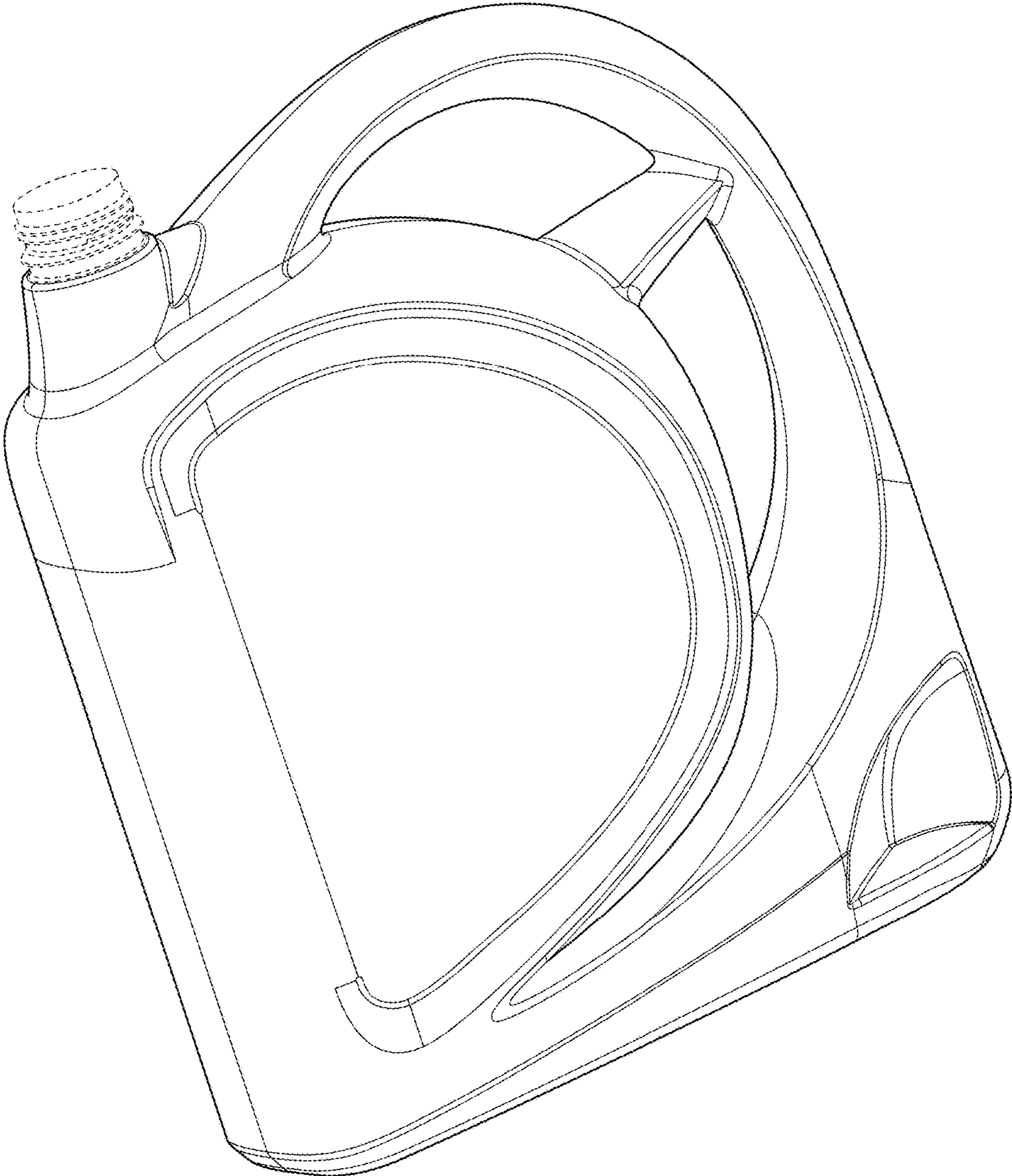

FIG. 4

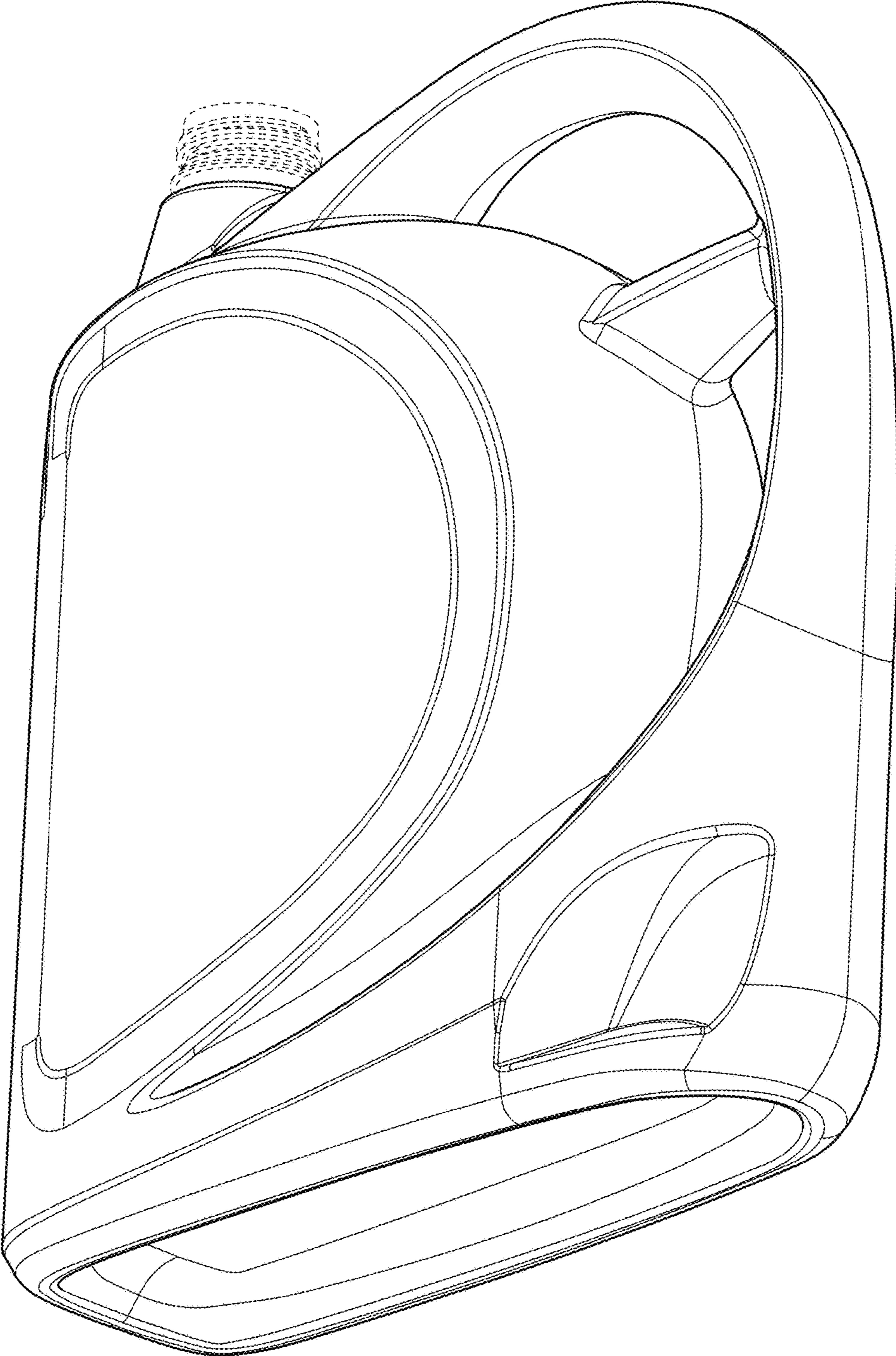

FIG. 5

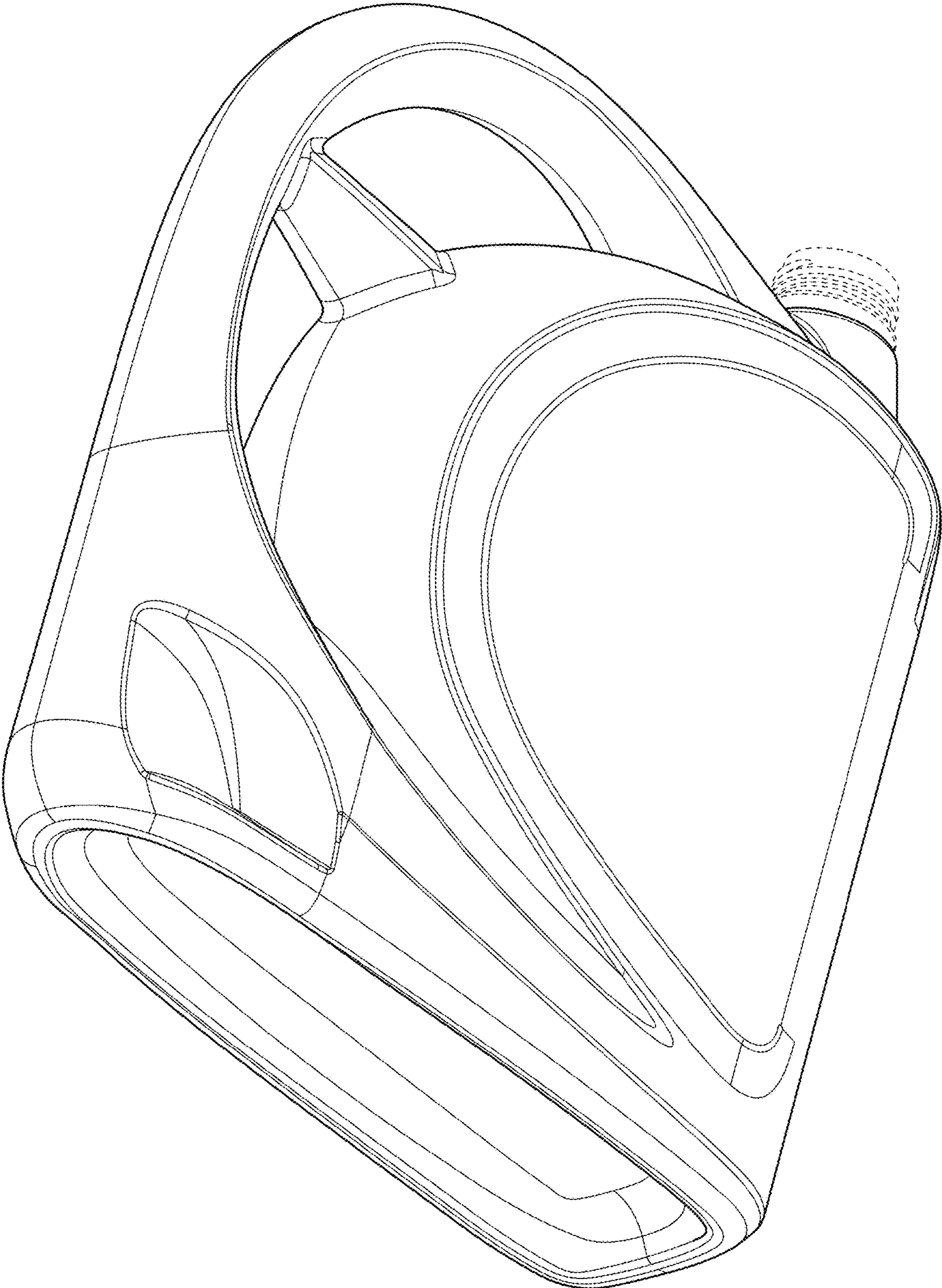

FIG. 6

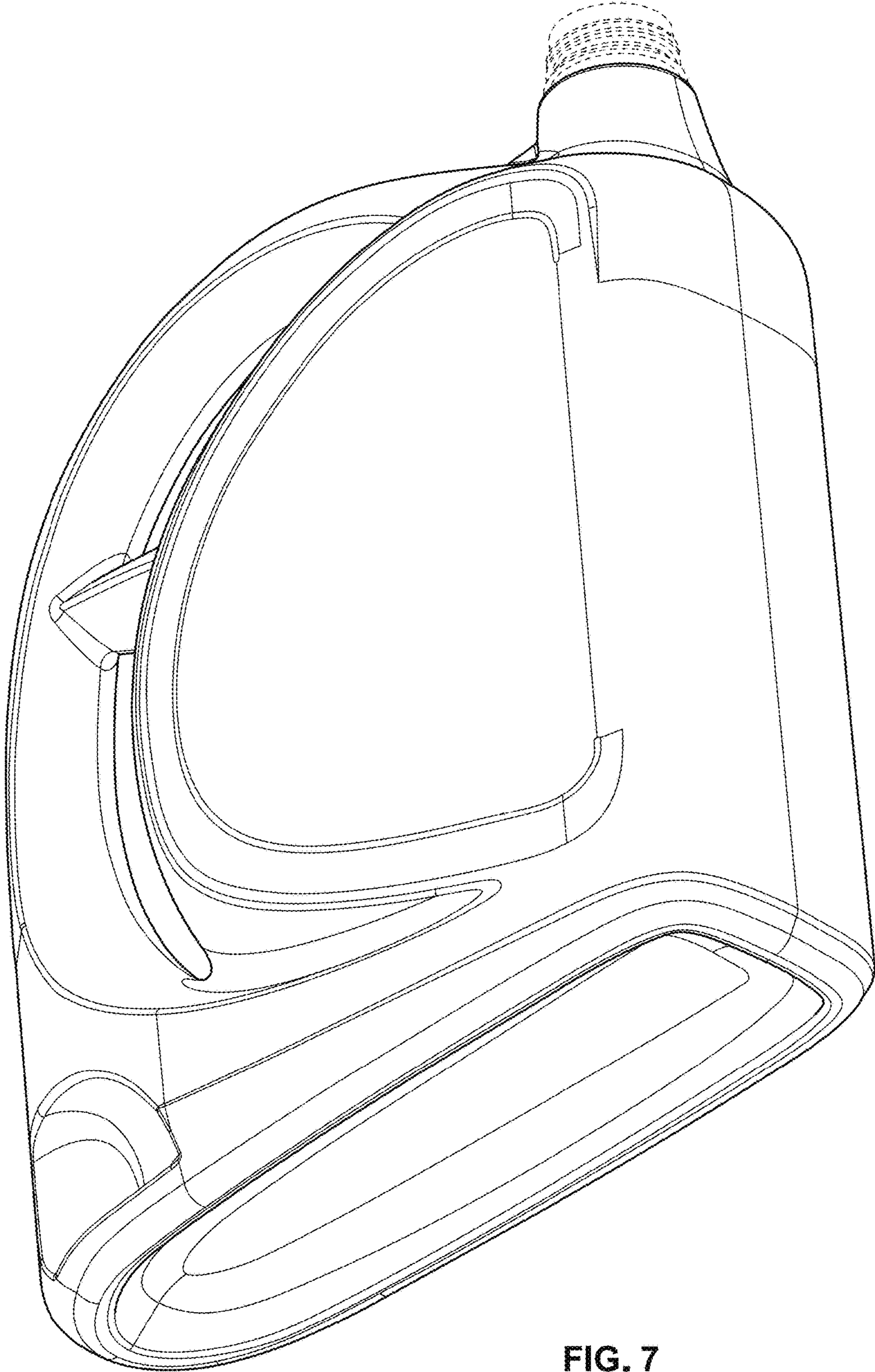

FIG. 7

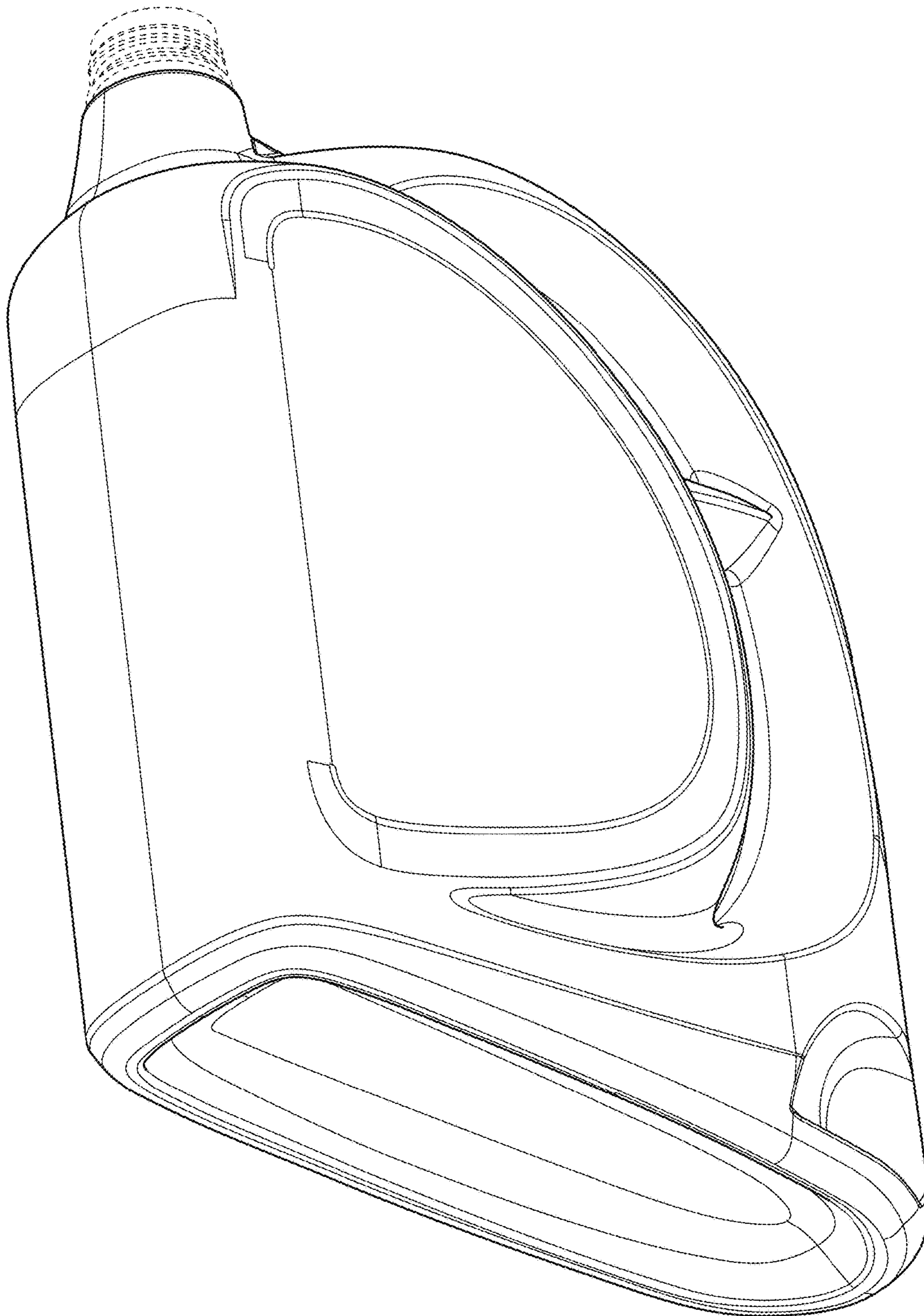

FIG. 8

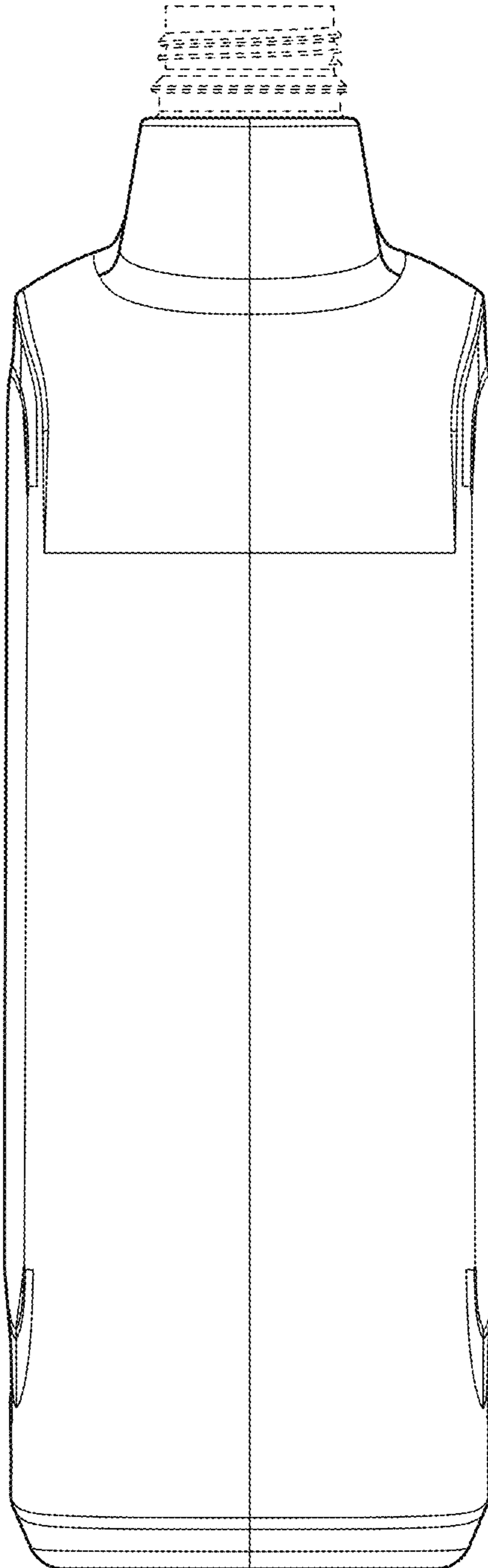

FIG. 9

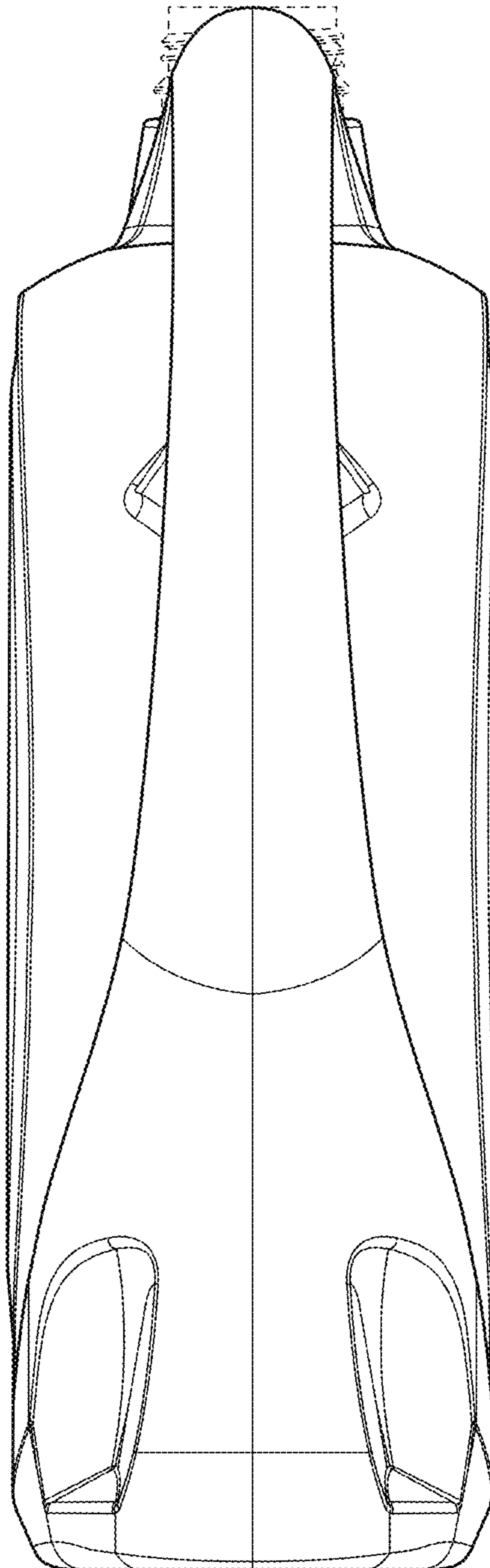

FIG. 10

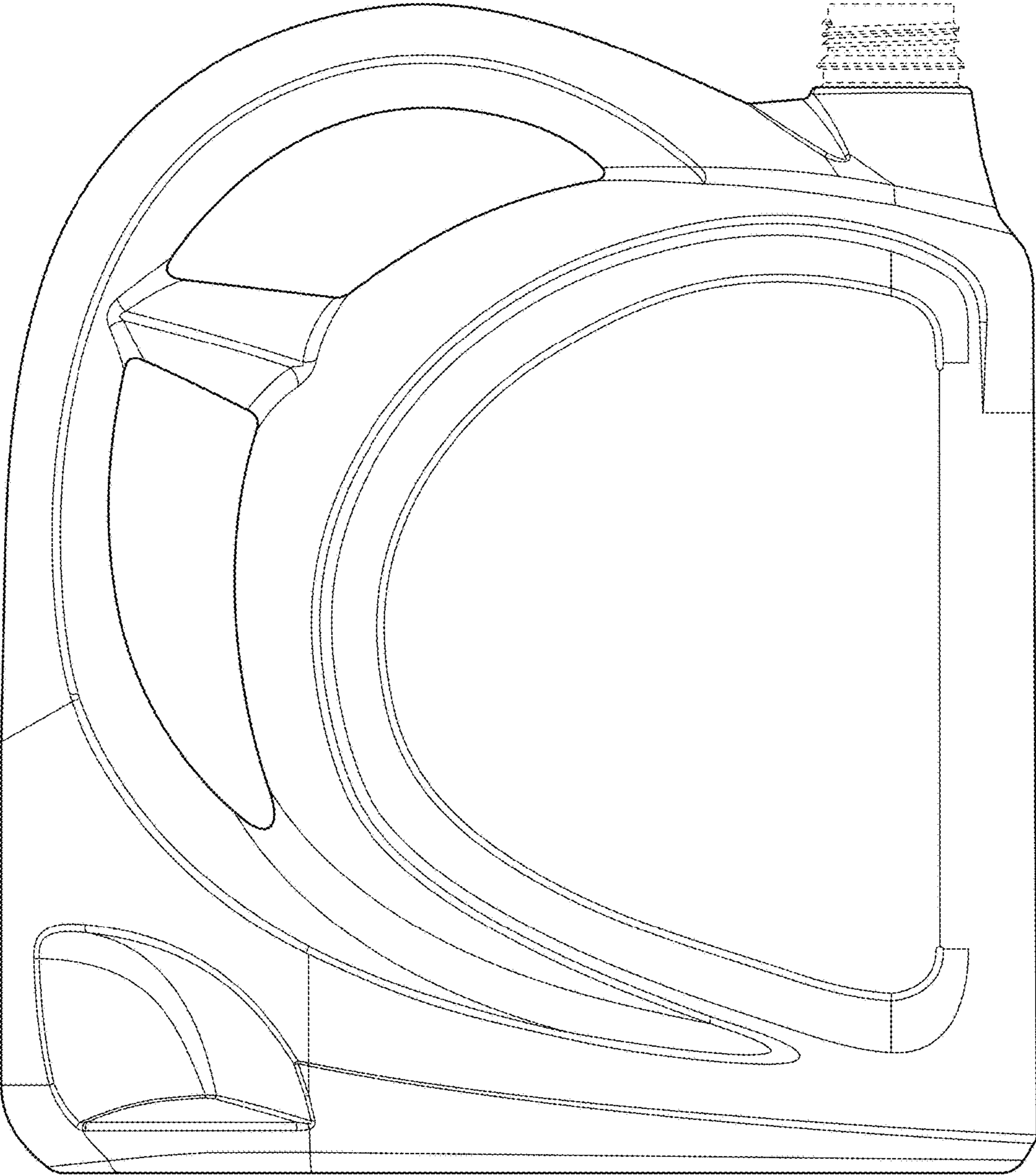

FIG. 11

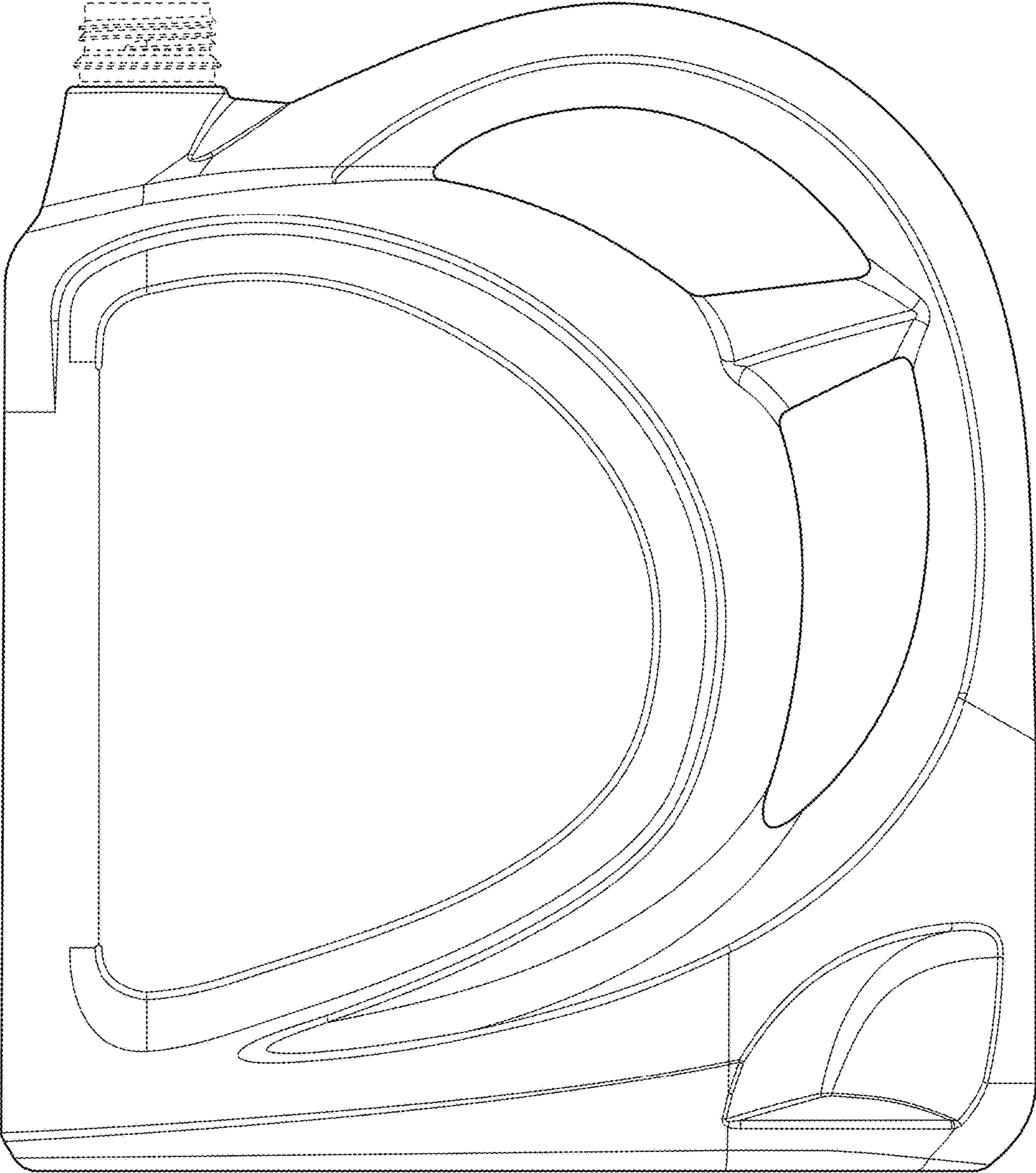

FIG. 12

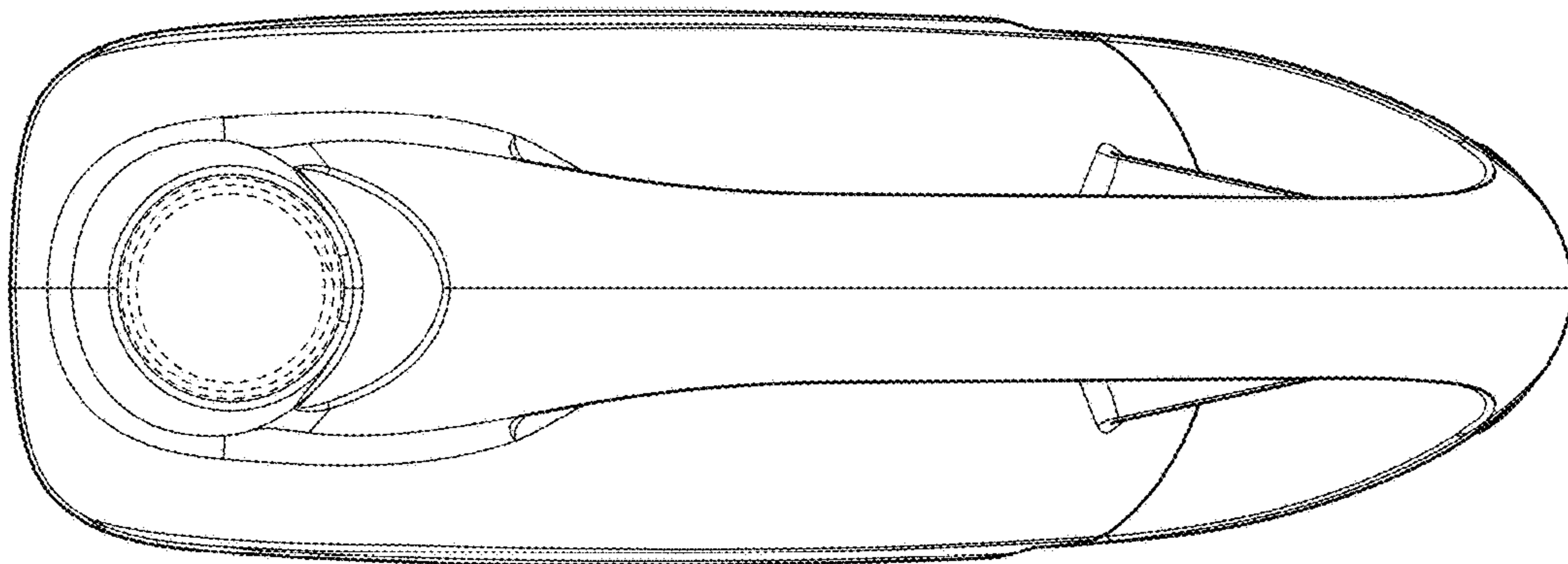

FIG. 13

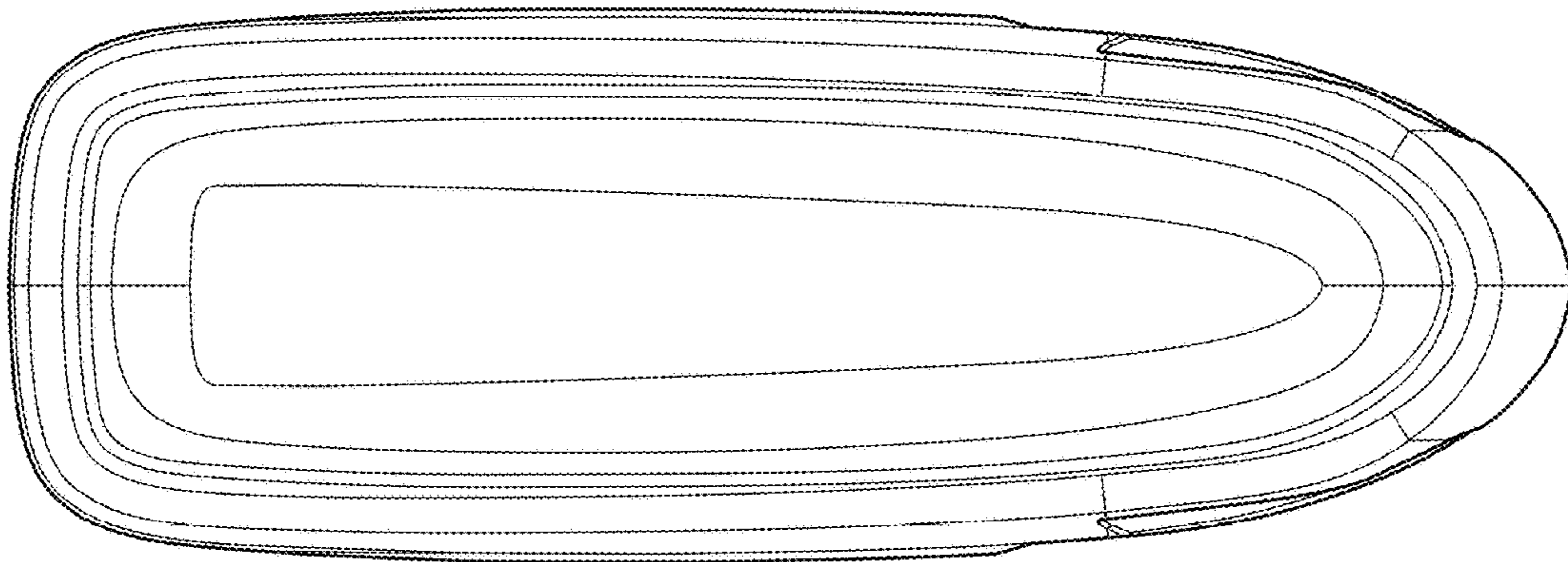

FIG. 14