

US00D797552S

(12) **United States Design Patent** (10) **Patent No.:** **US D797,552 S**
Thurin et al. (45) **Date of Patent:** **** Sep. 19, 2017**

- (54) **CONTAINER**
- (71) Applicant: **S.C. Johnson & Son, Inc.**, Racine, WI (US)
- (72) Inventors: **Matthew N. Thurin**, Wauwatosa, WI (US); **Rishabh Singh**, Milwaukee, WI (US); **Christopher M. Wlezien**, Chicago, IL (US); **Peter I. Capraro**, San Francisco, CA (US); **Allan Freas Velzy**, Boston, MA (US)
- (73) Assignee: **S.C. Johnson & Son, Inc.**, Racine, WI (US)
- (**) Term: **15 Years**
- (21) Appl. No.: **29/535,311**
- (22) Filed: **Aug. 5, 2015**

D7/629; D9/424, 428, 430, 432, 435, D9/449, 452; 220/212, 213, 260, 574, 220/660, 675, 781, 782, 783, 790, 791, 220/794
 CPC B65D 21/0233; B65D 2543/00203; B65D 43/08; B65D 2543/00296
 See application file for complete search history.

(56)

References Cited

U.S. PATENT DOCUMENTS

| | | | |
|--------------|---------|---------------------|--------|
| 1,542,115 A | 6/1925 | Weis | |
| 2,412,325 A | 12/1946 | Devine et al. | |
| 2,575,770 A | 11/1951 | Roop | |
| 2,606,586 A | 8/1952 | Hill | |
| 2,695,115 A | 11/1954 | Roop | |
| 3,117,692 A | 1/1964 | Carpenter et al. | |
| 3,262,602 A | 7/1966 | McConnell et al. | |
| 3,338,468 A | 8/1967 | Wilson | |
| 3,452,896 A | 7/1969 | Elliot | |
| 3,589,554 A | 6/1971 | Smith | |
| 3,981,401 A | 9/1976 | Blanchard | |
| 4,483,455 A | 11/1984 | Prophet, Jr. et al. | |
| D279,251 S | 6/1985 | Daenen et al. | |
| 4,562,937 A | 1/1986 | Iyengar | |
| 4,700,842 A | 10/1987 | Grusin | |
| 4,742,935 A | 5/1988 | Schellenberg | |
| 4,844,263 A | 7/1989 | Hadtke | |
| 4,899,925 A | 2/1990 | Bowden et al. | |
| 4,951,832 A | 8/1990 | Tenney et al. | |
| 5,184,745 A | 2/1993 | Havens et al. | |
| 5,356,026 A | 10/1994 | Andress et al. | |
| 5,377,860 A | 1/1995 | Littlejohn et al. | |
| 5,409,126 A | 4/1995 | DeMars | |
| D360,105 S | 7/1995 | Doxey | |
| 5,542,234 A | 8/1996 | Wyslowsky et al. | |
| 5,560,315 A | 10/1996 | Lampe | |
| 5,586,656 A | 12/1996 | Abrums | |
| 5,634,559 A | 6/1997 | Foos et al. | |
| D388,325 S * | 12/1997 | Tucker | D9/425 |
| 5,692,617 A | 12/1997 | Adams | |
| 5,709,304 A | 1/1998 | Credle, Jr. | |
| D390,109 S | 2/1998 | Tucker et al. | |
| 5,769,229 A | 6/1998 | Andress et al. | |
| 5,799,792 A | 9/1998 | Abrums | |
| 5,810,187 A | 9/1998 | Woodring | |
| D411,741 S | 6/1999 | Wilson et al. | |
| 5,992,679 A | 11/1999 | Porchia et al. | |
| D419,829 S | 2/2000 | Wilson et al. | |
| D420,252 S | 2/2000 | Loew et al. | |
| 6,032,827 A | 3/2000 | Zettle et al. | |

Related U.S. Application Data

- (63) Continuation of application No. 29/461,259, filed on Jul. 19, 2013, now Pat. No. Des. 741,171, and a continuation of application No. 29/461,254, filed on Jul. 19, 2013, now Pat. No. Des. 742,224, and a continuation of application No. 29/461,255, filed on Jul. 19, 2013, now Pat. No. Des. 752,973, and a continuation of application No. 29/461,250, filed on Jul. 19, 2013, now Pat. No. Des. 741,170, and a continuation of application No. 29/461,258, filed on Jul. 19, 2013, now Pat. No. Des. 744,336, and a continuation of application No. 29/461,252, filed on Jul. 19, 2013, now Pat. No. Des. 750,483, and a continuation of application No. 29/469,505, filed on Oct. 10, 2013, now Pat. No. Des. 741,708, and a continuation of application No. 29/469,506, filed on Oct. 10, 2013, now Pat. No. Des. 742,743, and a continuation of application No. 29/484,860, filed on Mar. 13, 2014, now Pat. No. Des. 760,073.
- (51) **LOC (10) Cl.** **09-03**
- (52) **U.S. Cl.**
USPC **D9/432; D7/602**
- (58) **Field of Classification Search**
USPC D7/391, 392, 392.1, 397, 538, 542, 602,

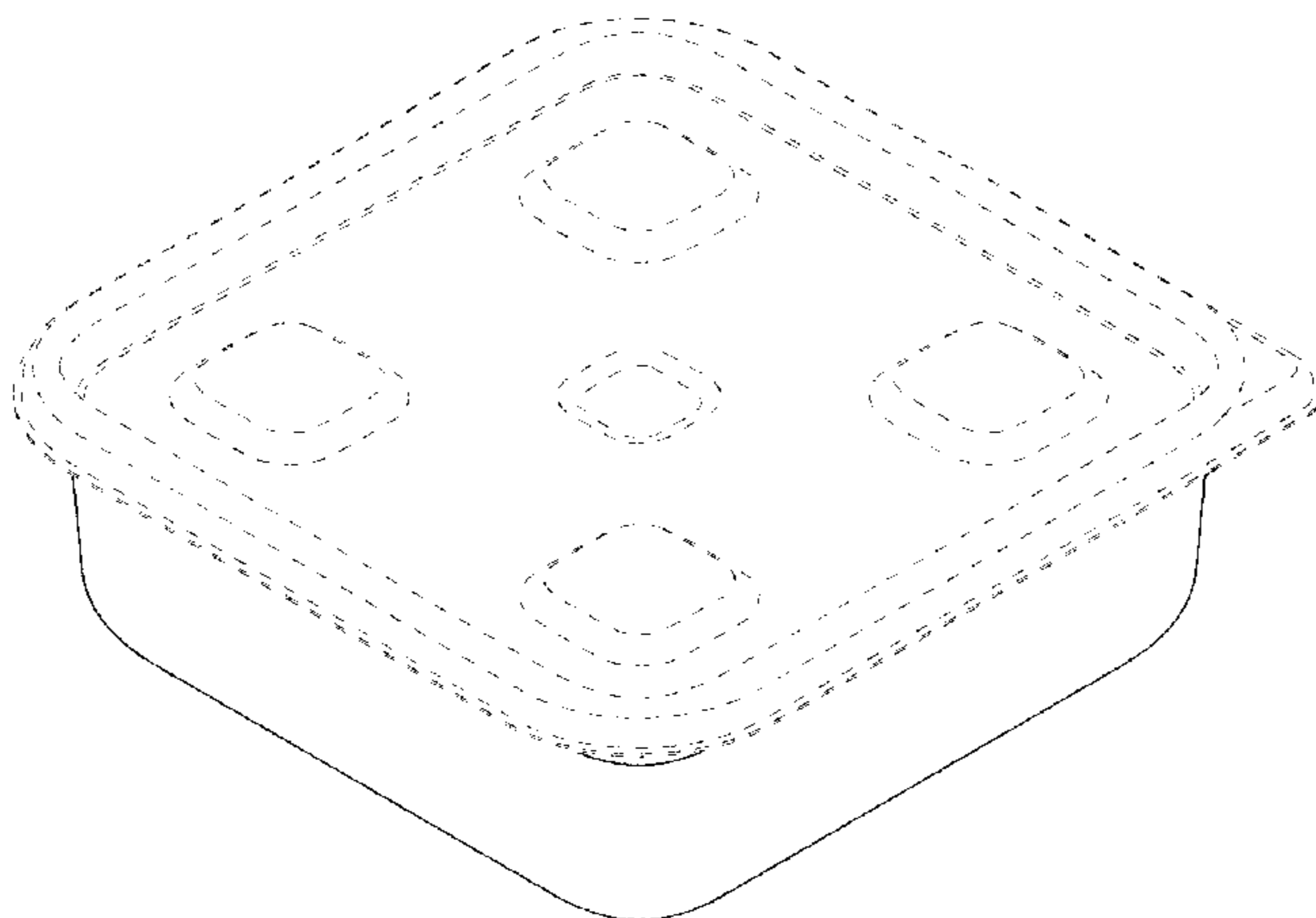

US D797,552 S

Page 2

| | | | | | | | |
|--------------|---------|-------------------|--------|-------------------|---------|------------------|---------------------------|
| D427,063 S | 6/2000 | May | | D589,759 S | 4/2009 | Ozery et al. | |
| D428,310 S | 7/2000 | Zettle et al. | | 7,549,540 B2 | 6/2009 | Lee et al. | |
| 6,168,044 B1 | 1/2001 | Zettle et al. | | D603,697 S | 11/2009 | Edwards et al. | |
| 6,170,696 B1 | 1/2001 | Tucker et al. | | D606,812 S | 12/2009 | Wu | |
| D439,744 S | 4/2001 | Ho | | 7,661,528 B2 | 2/2010 | Vovan et al. | |
| D440,470 S | 4/2001 | Tucker et al. | | D611,807 S | 3/2010 | Miga, Jr. | |
| D440,830 S * | 4/2001 | Tucker | D7/629 | D613,111 S | 4/2010 | Furlong | |
| D443,184 S | 6/2001 | Maxwell et al. | | D615,349 S | 5/2010 | Furlong | |
| D443,798 S | 6/2001 | Tucker et al. | | D618,516 S | 6/2010 | DiPietro et al. | |
| D446,117 S | 8/2001 | Conti | | 7,726,483 B2 * | 6/2010 | Ramanujam | B65D 21/0223 206/499 |
| D447,382 S | 9/2001 | Tucker et al. | | | | | |
| D448,606 S | 10/2001 | Conti | | 7,735,674 B2 | 6/2010 | Cai | |
| D448,969 S | 10/2001 | Conti | | D631,300 S * | 1/2011 | Samartgis | D7/602 |
| D449,495 S | 10/2001 | Tucker et al. | | 7,866,502 B2 | 1/2011 | Maxwell | |
| D450,983 S | 11/2001 | Tucker et al. | | D642,861 S | 8/2011 | Samartgis | |
| D451,769 S | 12/2001 | Stanos et al. | | D643,712 S * | 8/2011 | Samartgis | D9/424 |
| 6,415,945 B1 | 7/2002 | Zank et al. | | 8,006,513 B2 | 8/2011 | Roth et al. | |
| D462,880 S | 9/2002 | Maxwell et al. | | 8,011,205 B2 | 9/2011 | Roth et al. | |
| 6,467,647 B1 | 10/2002 | Tucker et al. | | 8,074,830 B2 | 12/2011 | Pomfrey | |
| D465,382 S | 11/2002 | Wolf et al. | | 8,083,084 B2 | 12/2011 | Vovan | |
| D466,364 S | 12/2002 | Demore | | 8,083,095 B2 | 12/2011 | Hui | |
| D472,774 S | 4/2003 | Pelstring et al. | | 8,118,190 B2 | 2/2012 | Coonce | |
| 6,557,720 B2 | 5/2003 | Tosdale et al. | | 8,123,064 B2 | 2/2012 | Vovan | |
| D485,468 S | 1/2004 | Roth et al. | | 8,146,766 B2 | 4/2012 | Vovan et al. | |
| D485,473 S | 1/2004 | Dais et al. | | 8,157,123 B2 | 4/2012 | Tucker et al. | |
| 6,672,473 B2 | 1/2004 | Torniainen et al. | | 8,308,021 B2 | 11/2012 | Turvey et al. | |
| 6,685,049 B1 | 2/2004 | Paladino | | 8,322,530 B2 | 12/2012 | Furlong | |
| D490,278 S | 5/2004 | Welsh | | 8,381,909 B2 | 2/2013 | Hernandez et al. | |
| 6,729,472 B2 | 5/2004 | Stucke et al. | | D677,568 S | 3/2013 | Sina | |
| 6,761,041 B2 | 7/2004 | Roth et al. | | D719,399 S | 12/2014 | Thurin et al. | |
| 6,796,430 B2 | 9/2004 | Mercier et al. | | D720,178 S | 12/2014 | Thurin et al. | |
| 6,874,650 B2 | 4/2005 | Welsh et al. | | D721,246 S | 1/2015 | Thurin et al. | |
| 6,886,694 B2 | 5/2005 | McNeeley et al. | | D723,864 S | 3/2015 | Thurin et al. | |
| D505,835 S | 6/2005 | Schultz et al. | | D723,914 S | 3/2015 | Singh et al. | |
| D505,839 S | 6/2005 | Stanos et al. | | D724,891 S | 3/2015 | Capraro et al. | |
| D505,840 S | 6/2005 | Schultz et al. | | D725,433 S | 3/2015 | Singh et al. | |
| D506,106 S | 6/2005 | Ordiway et al. | | D741,171 S * | 10/2015 | Thurin | D9/432 |
| D506,359 S | 6/2005 | Zettle et al. | | D759,478 S * | 6/2016 | Fife | D9/425 |
| 6,910,599 B2 | 6/2005 | Tucker et al. | | D772,058 S * | 11/2016 | Urushidani | D9/432 |
| D507,155 S | 7/2005 | Gosen et al. | | D787,275 S * | 5/2017 | Carlson | D7/602 |
| D507,937 S | 8/2005 | Dais et al. | | 2004/0144781 A1 | 7/2004 | Dees et al. | |
| D508,187 S | 8/2005 | Dais et al. | | 2006/0011626 A1 | 1/2006 | Palder | |
| D508,188 S | 8/2005 | Zettle et al. | | 2006/0070907 A1 | 4/2006 | O'Shea | |
| D511,435 S | 11/2005 | Roth et al. | | 2007/0007298 A1 * | 1/2007 | Tucker | B65D 43/0206 220/791 |
| D512,278 S | 12/2005 | Schultz et al. | | | | | |
| D514,390 S | 2/2006 | Palder | | 2007/0119743 A1 | 5/2007 | Tucker et al. | |
| D516,859 S | 3/2006 | Zettle et al. | | 2007/0187277 A1 | 8/2007 | Furlong | |
| 7,017,775 B2 | 3/2006 | Zettle et al. | | 2008/0105630 A1 | 5/2008 | Lown | |
| 7,032,773 B2 | 4/2006 | Dees et al. | | 2008/0203096 A1 * | 8/2008 | Maxwell | B65D 51/1672 220/374 |
| D522,319 S | 6/2006 | Palder | | | | | |
| 7,063,231 B2 | 6/2006 | Stanos et al. | | 2009/0084796 A1 | 4/2009 | Coonce et al. | |
| D526,161 S | 8/2006 | Roth et al. | | 2009/0145797 A1 | 6/2009 | Steinmeyer | |
| D527,224 S | 8/2006 | Roth et al. | | 2009/0173656 A1 | 7/2009 | Furlong | |
| D527,951 S | 9/2006 | Roth et al. | | 2010/0006467 A1 | 1/2010 | Joseph et al. | |
| D527,952 S | 9/2006 | Roth et al. | | 2010/0065461 A1 | 3/2010 | Chhay | |
| D527,954 S | 9/2006 | Roth | | 2010/0170824 A1 | 7/2010 | Ramanujam et al. | |
| D536,922 S | 2/2007 | Roth et al. | | 2010/0176022 A1 | 7/2010 | Furlong | |
| D536,923 S | 2/2007 | Roth et al. | | 2010/0181323 A1 | 7/2010 | Thaler et al. | |
| D542,100 S | 5/2007 | Kim | | 2010/0200588 A1 | 8/2010 | Bergman et al. | |
| 7,216,769 B2 | 5/2007 | Palder | | 2011/0031153 A1 | 2/2011 | Vovan | |
| D545,618 S | 7/2007 | Zettle et al. | | 2011/0114638 A1 | 5/2011 | Kettner et al. | |
| D547,177 S | 7/2007 | Sherman et al. | | 2011/0309075 A1 | 12/2011 | Roth et al. | |
| D548,538 S | 8/2007 | Liu | | 2011/0315702 A1 | 12/2011 | LeBoeuf et al. | |
| 7,261,219 B2 | 8/2007 | Tucker et al. | | 2012/0006837 A1 | 1/2012 | Becklin | |
| D551,496 S | 9/2007 | Ablo et al. | | 2012/0048874 A1 | 3/2012 | Oakes et al. | |
| 7,264,135 B2 | 9/2007 | Savicki et al. | | 2015/0021321 A1 * | 1/2015 | Gosen | B65D 21/0223 220/23.83 |
| D555,475 S | 11/2007 | Enriquez et al. | | | | | |
| D556,517 S | 12/2007 | Lown et al. | | | | | |
| 7,347,327 B2 | 3/2008 | Lobman et al. | | | | | |
| 7,357,272 B2 | 4/2008 | Maxwell | | | | | |
| D568,693 S | 5/2008 | Furlong | | | | | |
| D568,694 S * | 5/2008 | Furlong | D7/629 | | | | |
| D569,722 S | 5/2008 | Stamper et al. | | | | | |
| 7,380,412 B2 | 6/2008 | Roth et al. | | | | | |
| D575,100 S | 8/2008 | Liu | | | | | |
| 7,451,875 B1 | 11/2008 | Norris | | | | | |
| D585,699 S | 2/2009 | Furlong | | | | | |
| D586,179 S | 2/2009 | Furlong | | | | | |
| D588,417 S | 3/2009 | Doliwa | | | | | |

FOREIGN PATENT DOCUMENTS

| | | |
|----|-------------------|---------|
| GB | Des. 4021888 | 10/2011 |
| JP | 2012-001467 | 1/2012 |
| WO | WO 2012/009035 A1 | 1/2012 |

OTHER PUBLICATIONS

Infantino Annabel Karmel Feeding Accessories, <<http://www.thanksmailcarrier.com/2010/11/infantino-annabel-karmel-feeding.html>>, accessed Jan. 25, 2013.

LunchBlox™ Sandwich Kit, <http://www.rubbermaid.com/category/pages/productdetail.aspx?Prod_ID=RP092026>, accessed Jan. 25, 2013.

Play With Your Food: Lego Bento Box, <<http://kawaii-fabric.com/tag/fun-bento-boxes/>>, accessed Jan. 25, 2013.

Set of 5 Stackable Containers, <<http://www.etsy.com/listing/50125726/set-5-of-stackable-containers>>, accessed Jan. 25, 2013.

* cited by examiner

Primary Examiner — Robert M Spear

Assistant Examiner — Kendra L Hamilton

(57) **CLAIM**

The ornamental design for a container, as shown and described.

DESCRIPTION

FIG. 1 is a bottom view thereof; and

FIG. 2 is a bottom perspective view thereof.

FIG. 3 is a rear view thereof;

FIG. 4 is a right side view thereof;

FIG. 5 is a left side view thereof;

FIG. 6 is a top view thereof;

FIG. 7 is a bottom view thereof; and,

FIG. 8 is a bottom perspective view thereof.

The broken lines in the Figures show portions of the container which form no part of the claimed design.

1 Claim, 8 Drawing Sheets

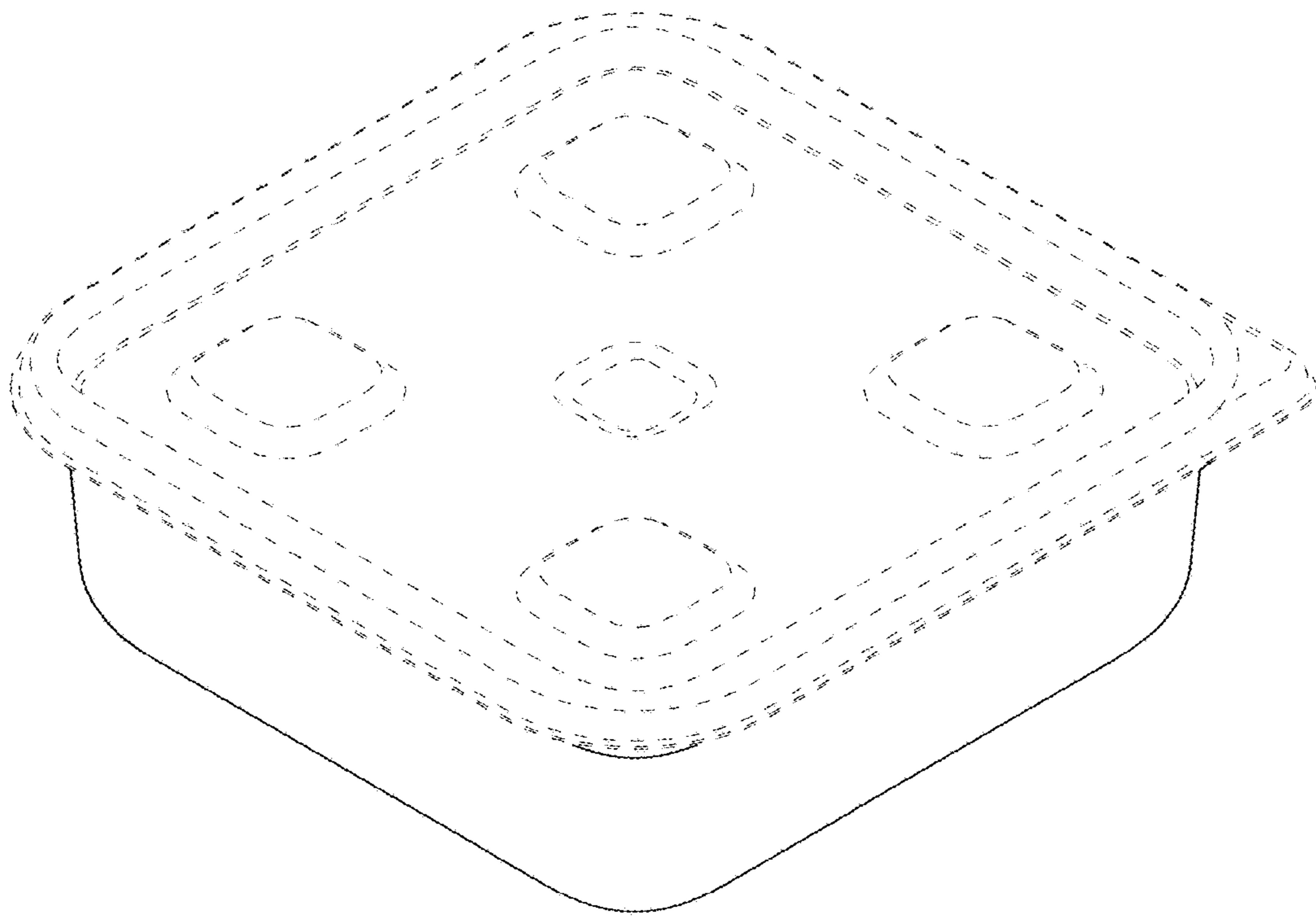

FIG. 1

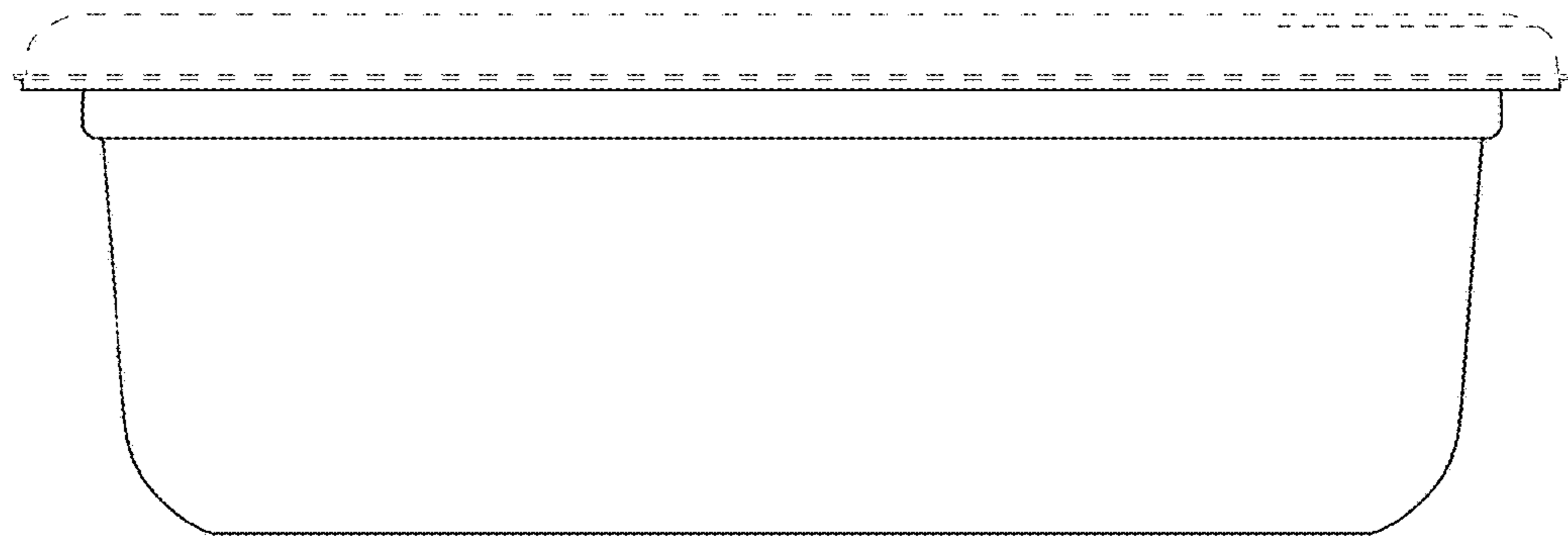

FIG. 2

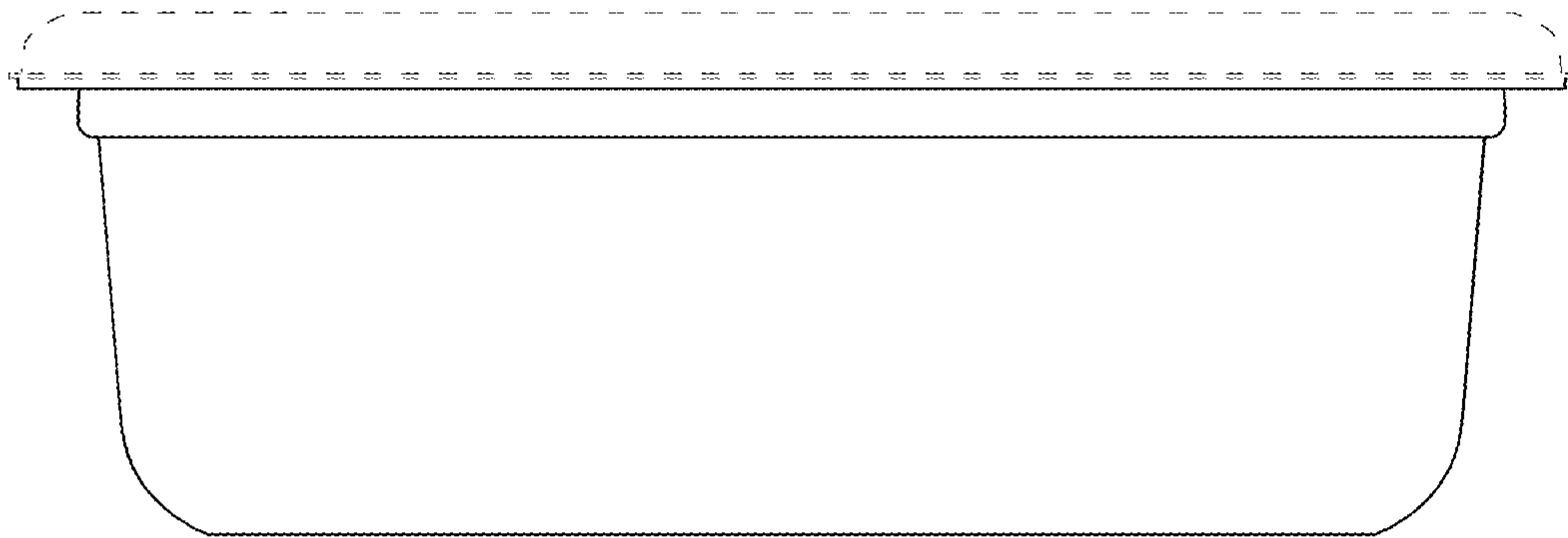

FIG. 3

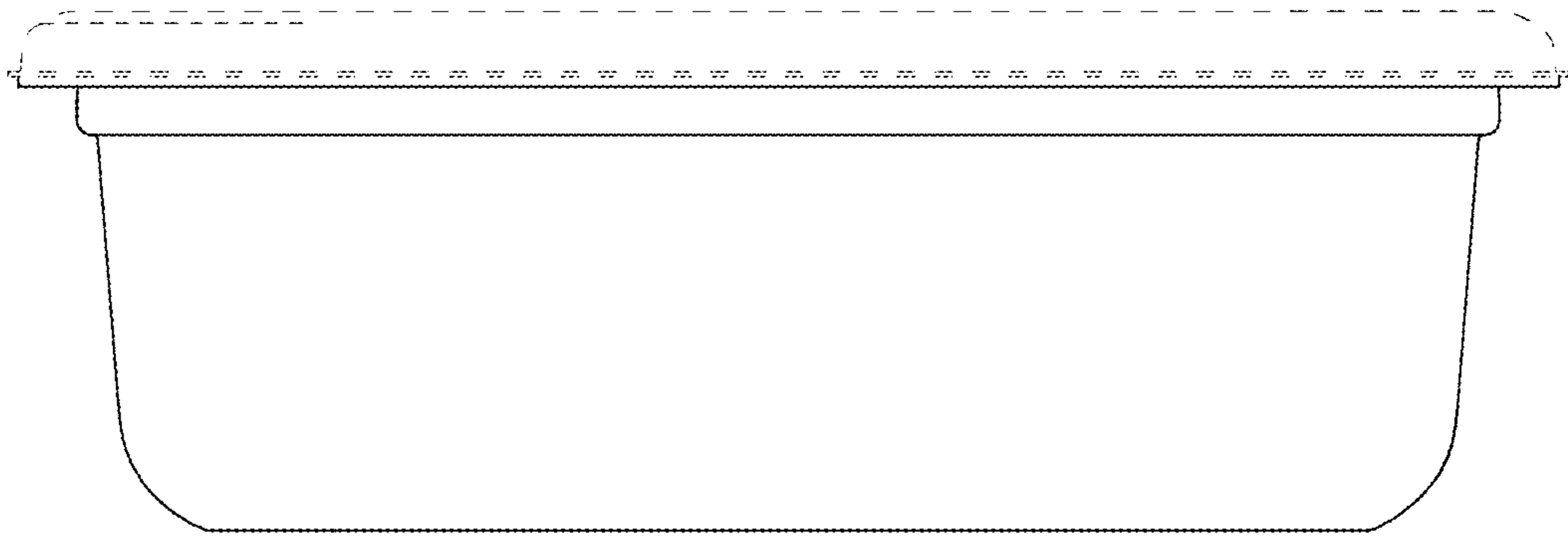

FIG. 4

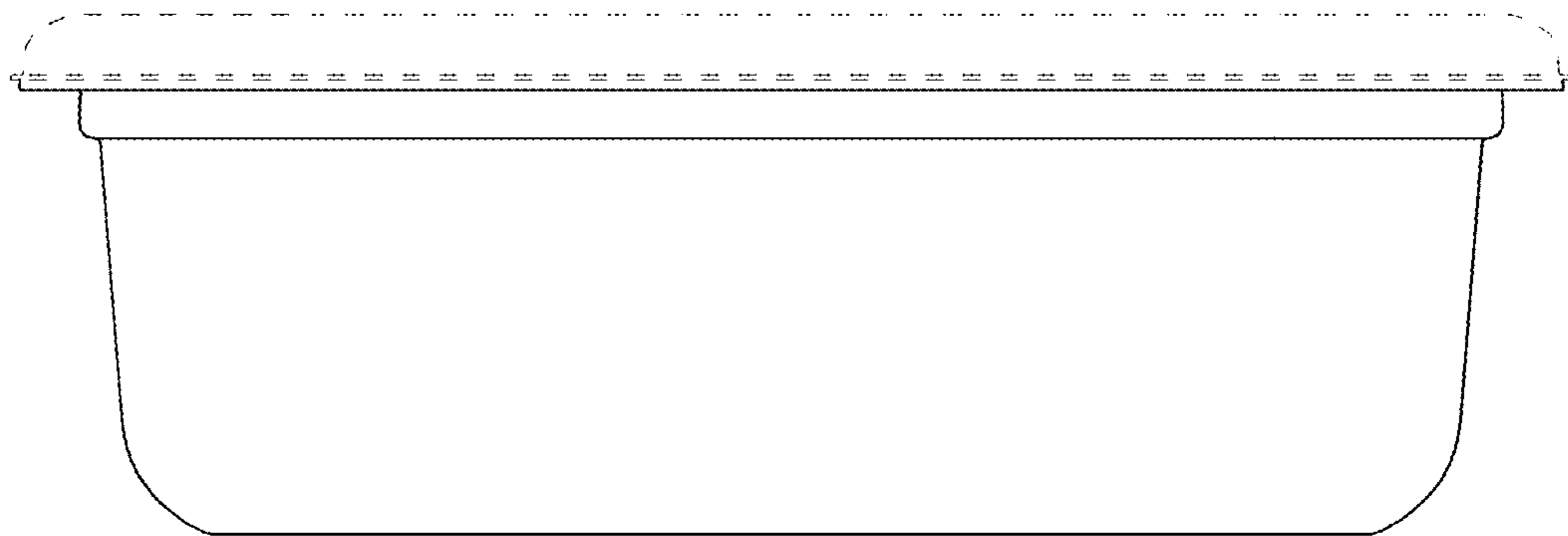

FIG. 5

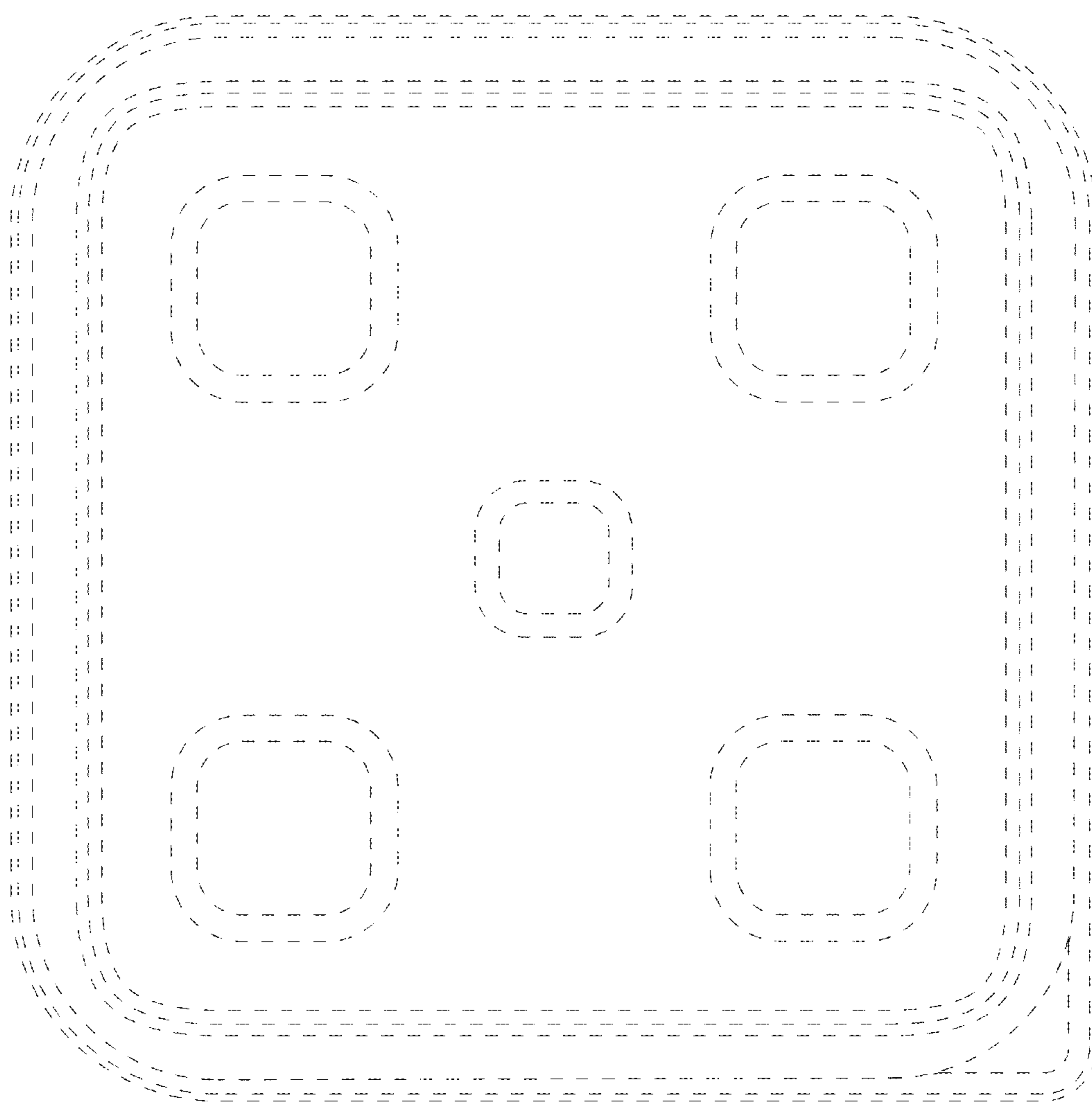

FIG. 6

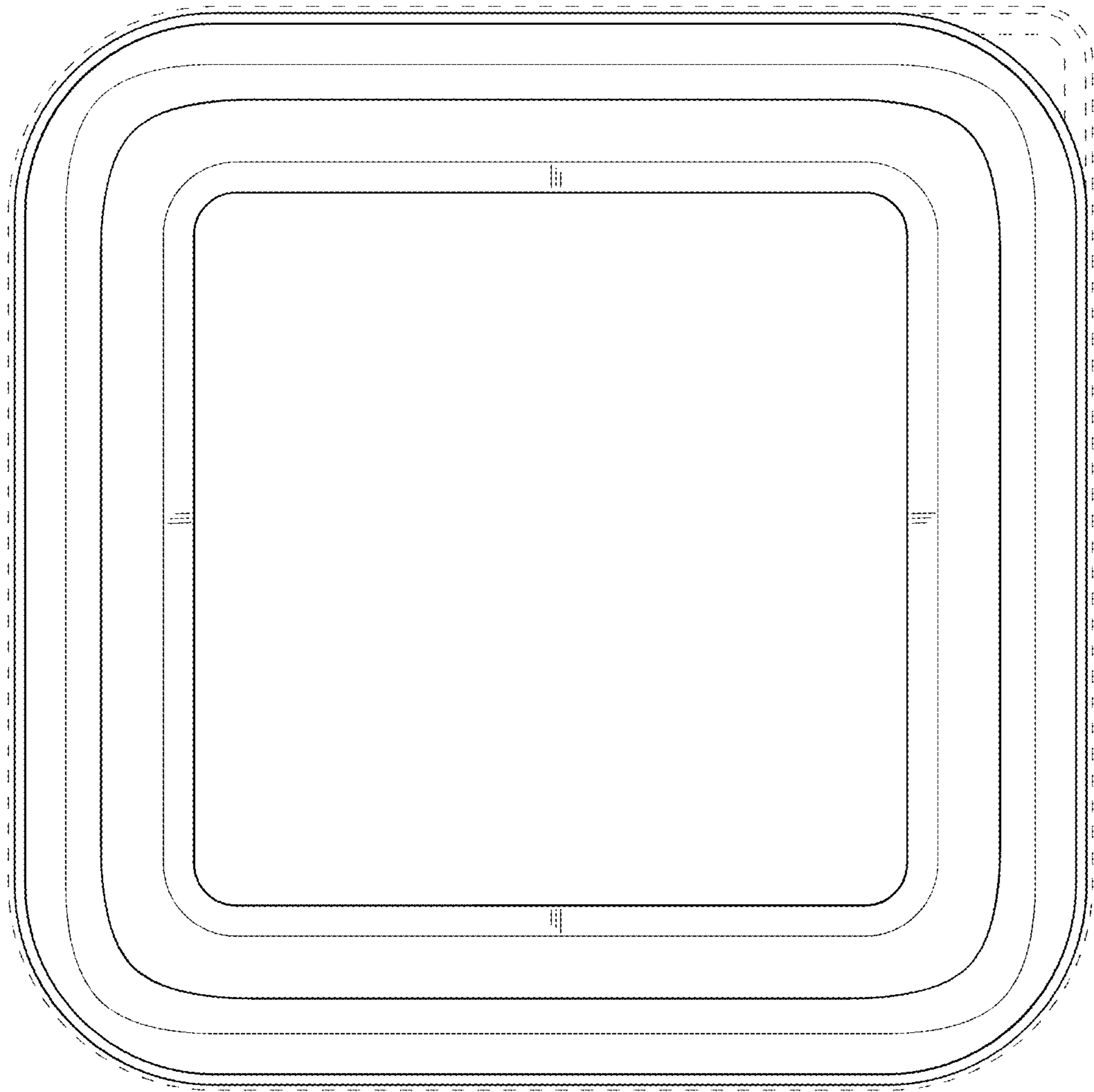

FIG. 7

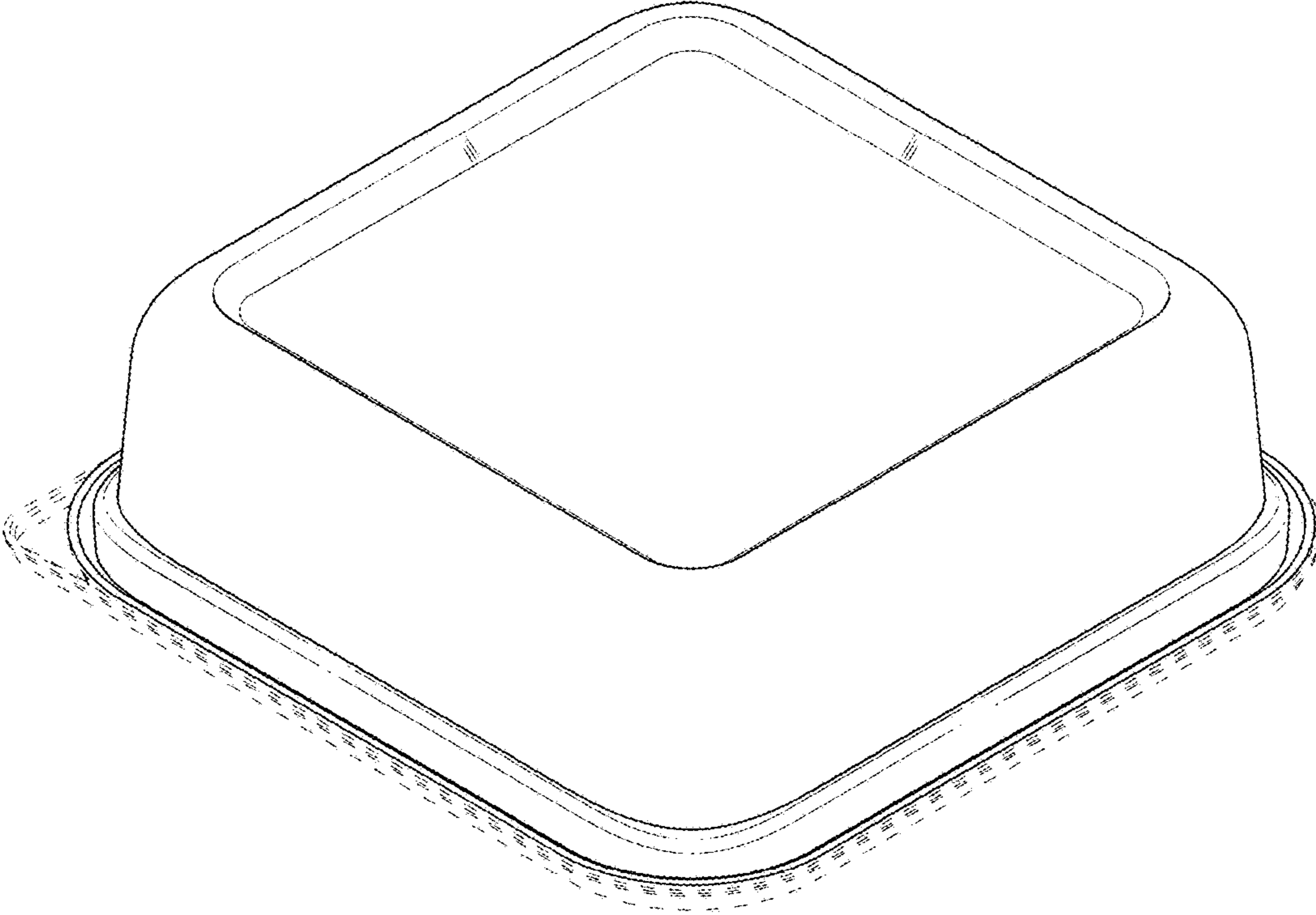

FIG. 8