



US00D797446S

(12) **United States Design Patent**
Kang et al.

(10) **Patent No.:** **US D797,446 S**

(45) **Date of Patent:** **** Sep. 19, 2017**

(54) **WALLET**

FOREIGN PATENT DOCUMENTS

(71) Applicant: **SAMSUNG DISPLAY CO., LTD.**,
Yongin-si, Gyeonggi-do (KR)

KR 30-0662693 S 10/2012
KR 30-0662694 S 10/2012

(Continued)

(72) Inventors: **Kinyeng Kang**, Yongin-si (KR);
Mugyeom Kim, Yongin-si (KR)

OTHER PUBLICATIONS

(73) Assignee: **Samsung Display Co., Ltd.**, Yongin-si
(KR)

Tyvek Paper Wallet. Slimfold—Plain White. by BristolPaperWal-
letCo, posted at Etsy.com, posting date Dec. 11, 2013, © 2016 Etsy,
Inc., [online], [site visited Jun. 20, 2016]. Available from Internet,
<URL: https://www.etsy.com/listing/113911119/tyvek-paper-wal-let-slimfold-plain-white?ref=shop_home_active_1>.*

(Continued)

(**) Term: **15 Years**

Primary Examiner — Susan E Krakower

(21) Appl. No.: **29/537,864**

Assistant Examiner — Lisa A Grabenstetter

(22) Filed: **Aug. 28, 2015**

(74) *Attorney, Agent, or Firm* — Lewis Roca Rothgerber
Christie LLP

(30) **Foreign Application Priority Data**

Mar. 6, 2015 (KR) 30-2015-0011544

(51) **LOC (10) Cl.** **03-01**

(52) **U.S. Cl.**
USPC **D3/249; D14/341**

(58) **Field of Classification Search**

USPC D3/20, 203.6, 205, 206, 208, 226, 232,
D3/245, 247–253, 303, 324; D14/251;
D19/3, 27, 75, 86, 91, 102

CPC A45C 1/06; A45C 3/08
See application file for complete search history.

(57) **CLAIM**

The ornamental design for a wallet, as shown and described.

DESCRIPTION

FIG. 1 is a perspective view of an embodiment of a wallet,
showing our new design;

FIG. 2 is a front view thereof;

FIG. 3 is a rear view thereof;

FIG. 4 is a left-side view thereof;

FIG. 5 is a right-side view thereof;

FIG. 6 is a top plan view thereof;

FIG. 7 is a bottom plan view thereof; and,

FIG. 8 is another perspective view thereof, shown in an open
configuration in a condition of use.

The broken lines indicate unclaimed environmental struc-
tures. The broken lines on the surface of the wallet in FIG.
8 indicated unclaimed surface indicia.

(56) **References Cited**

U.S. PATENT DOCUMENTS

1,148,934 A * 8/1915 Shuey B42F 1/06
24/563
2,384,199 A * 9/1945 Sherwood A45C 1/06
150/133
D179,097 S * 10/1956 Smith D3/252
2,839,184 A * 6/1958 April A24F 27/12
206/118
2,996,174 A * 8/1961 Will A24F 27/04
206/104

(Continued)

1 Claim, 5 Drawing Sheets

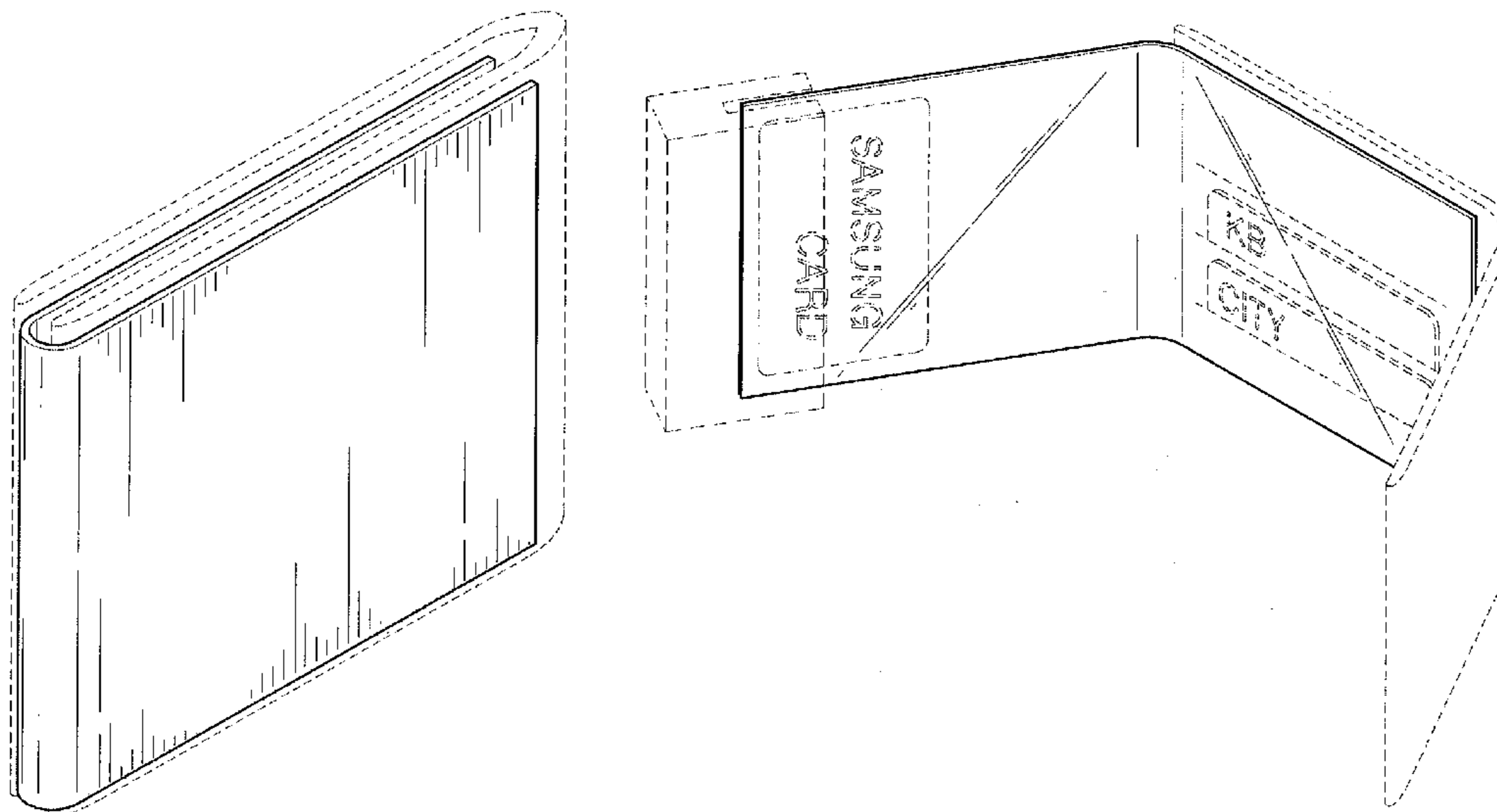

(56)

References Cited

U.S. PATENT DOCUMENTS

3,903,945 A * 9/1975 Skeba A45C 1/06
150/133
4,126,916 A * 11/1978 Thomas B42F 1/02
24/546
D270,747 S * 9/1983 Eisinger 224/918
4,671,332 A * 6/1987 McPhee A45C 1/06
150/132
D292,071 S * 9/1987 Weir D6/541
D410,774 S * 6/1999 Inbert D3/247
6,357,084 B1 * 3/2002 Haidon A45C 1/00
24/16 R
D467,420 S * 12/2002 Bodony D3/249
D470,806 S * 2/2003 Voves D12/191
D477,634 S * 7/2003 Malone D19/26
D524,051 S * 7/2006 Krueger D3/303
D600,011 S * 9/2009 Munroe D3/247
D616,493 S * 5/2010 Burge D19/34
D621,618 S * 8/2010 Fahrendorff D3/303
D699,122 S * 2/2014 Thuesen D9/701

2010/0078101 A1* 4/2010 Styron A45C 1/06
150/137
2014/0145161 A1 5/2014 Naijo
2014/0226275 A1* 8/2014 Ko G06F 1/1626
361/679.27

FOREIGN PATENT DOCUMENTS

KR 30-0662695 S 10/2012
KR 10-2012-0136471 A 12/2012

OTHER PUBLICATIONS

Poketo x Booooooom Wallet Collection—Imagine the After Life, posted at Sixand5.com, posting date Jun. 14, 2011, [online], [site visited Jul. 25, 2016]. Available from Internet, <URL: <https://sixand5.com/2011/06/14/poketo-x-booooooom-wallet-collection-imagine-the-after-life/>>.*
Oyster card travel card wallets, posted at Craftedlines.co.uk, posting date Jul. 28, 2013, © 2012 Craftedlines.co.uk [online], [site visited Jul. 25, 2016]. Available from Internet, <URL: <https://web.archive.org/web/20130728060917/http://www.craftedlines.co.uk/>>.*

* cited by examiner

FIG. 1

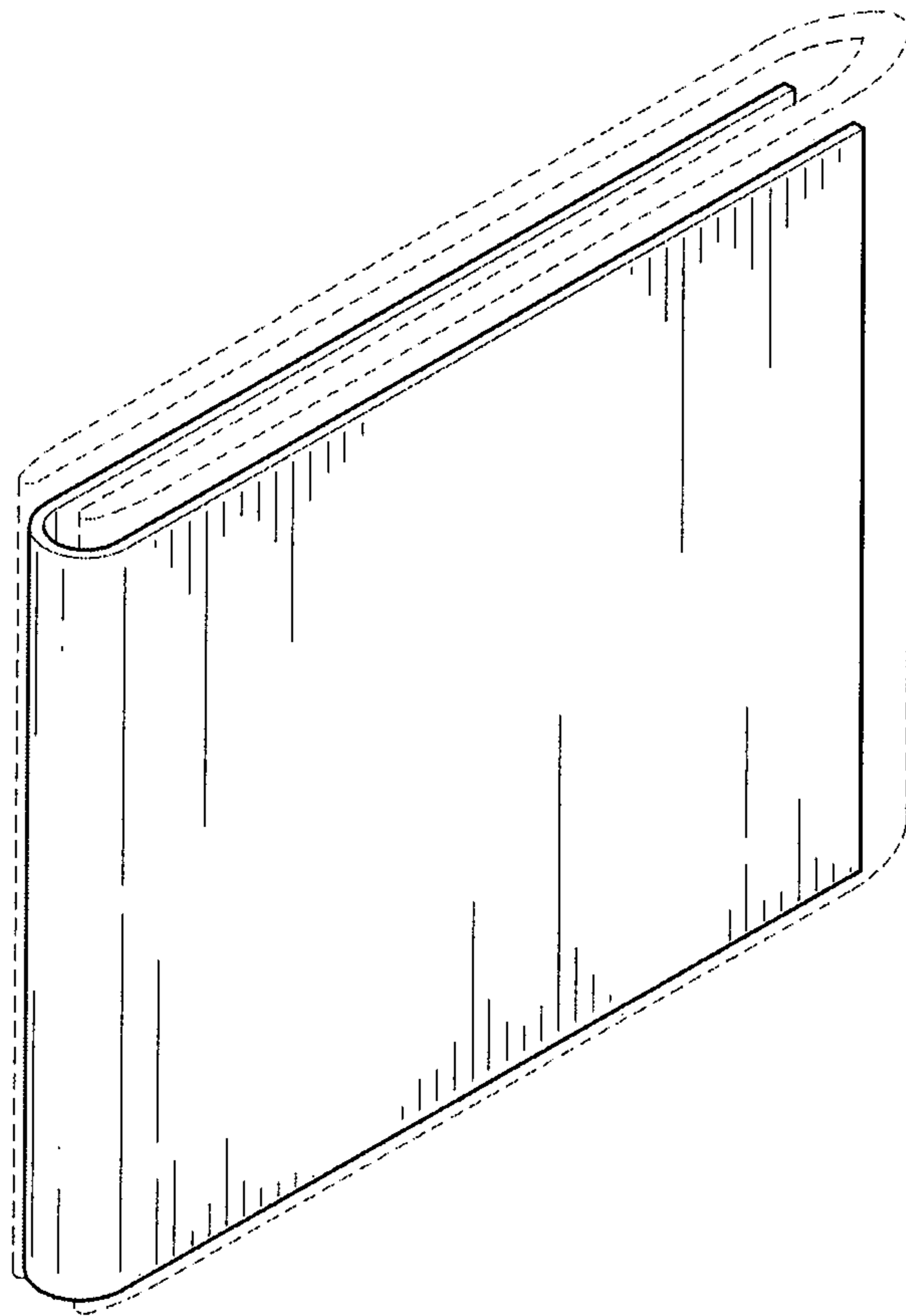

FIG. 2

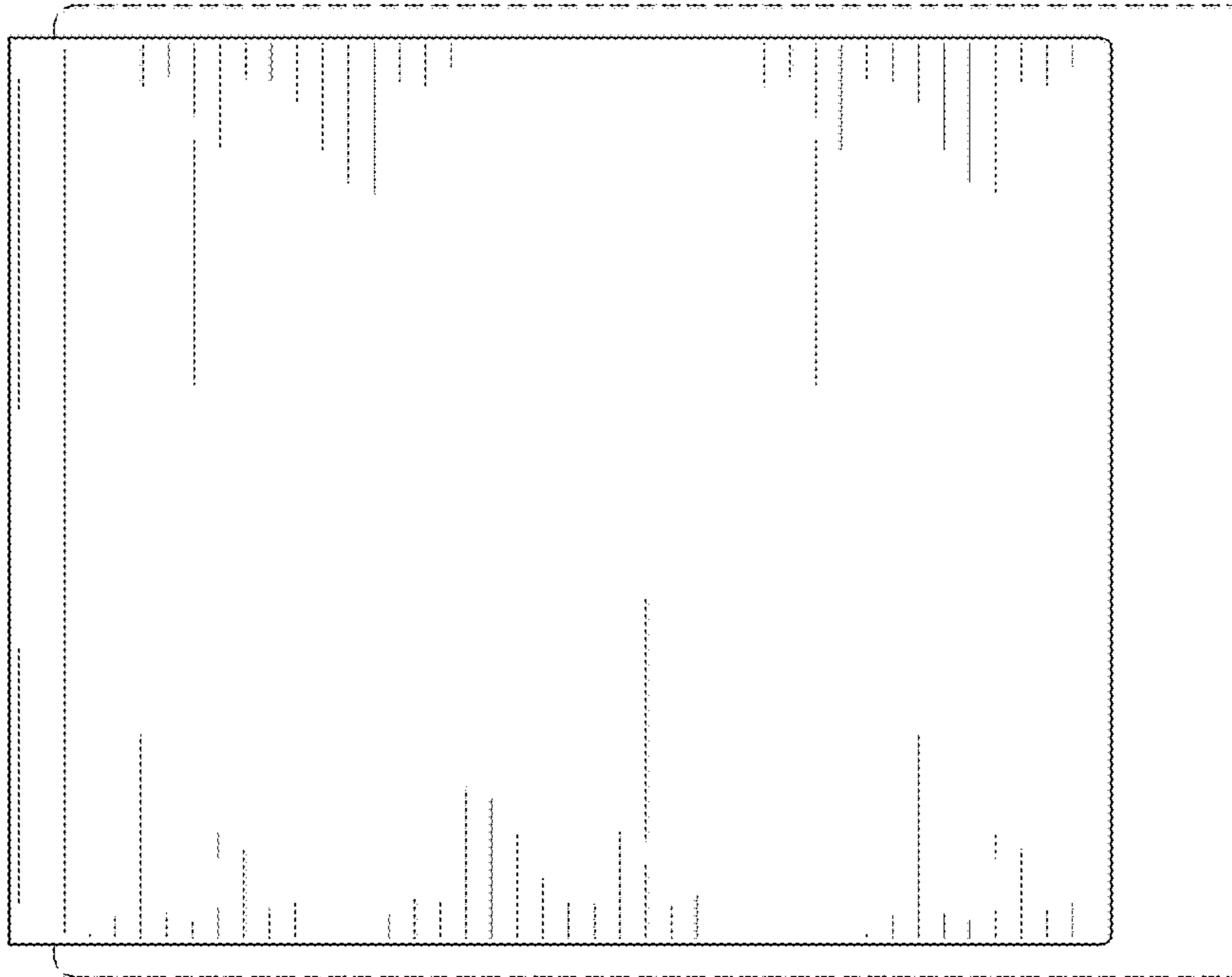

FIG. 3

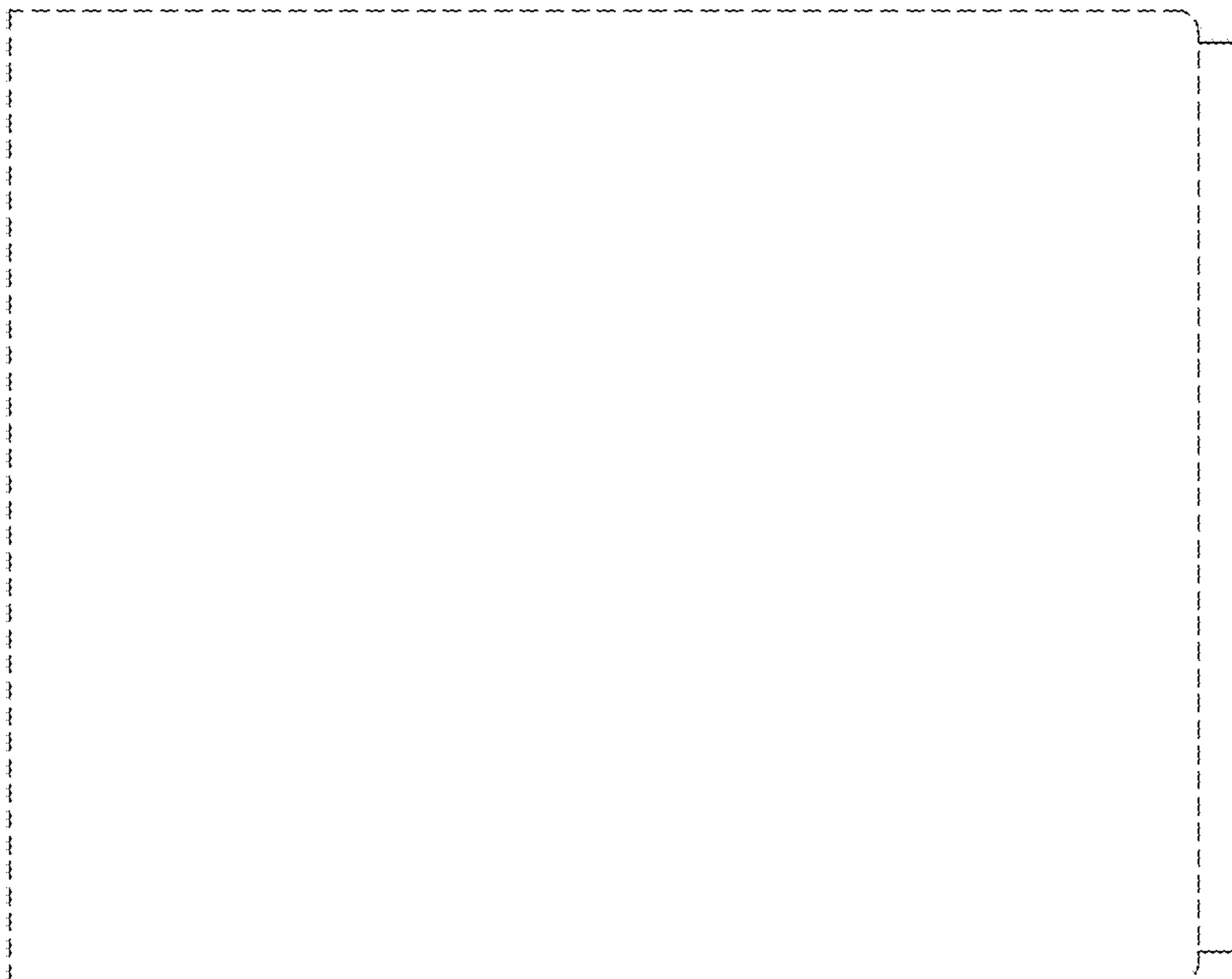

FIG. 4

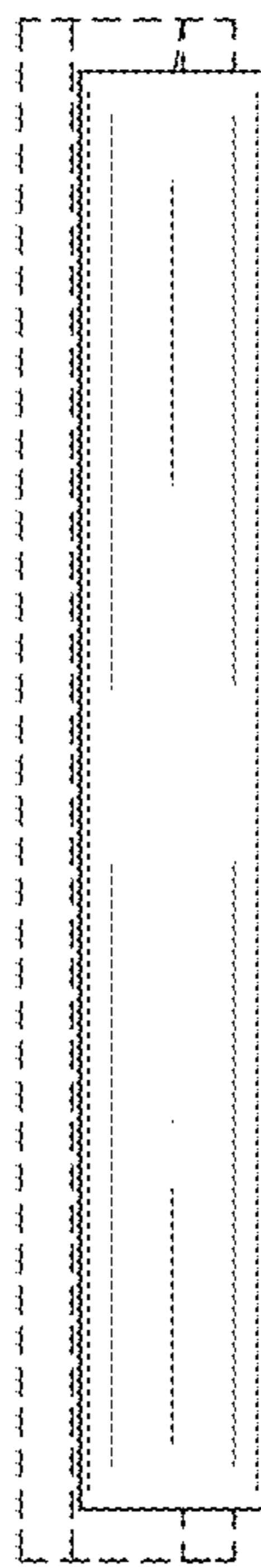

FIG. 5



FIG. 6

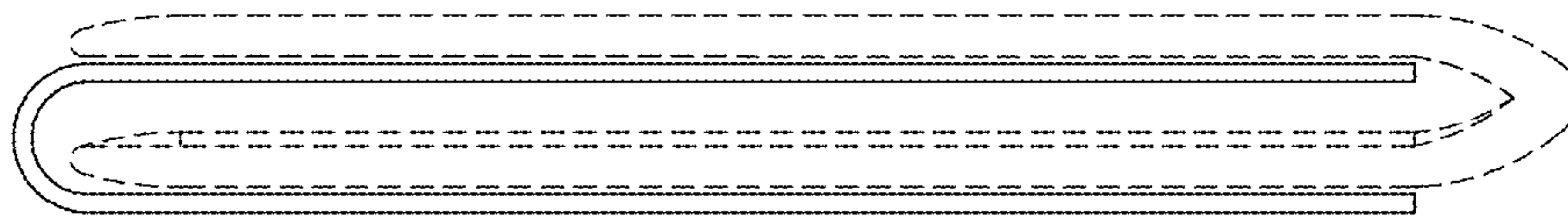

FIG. 7

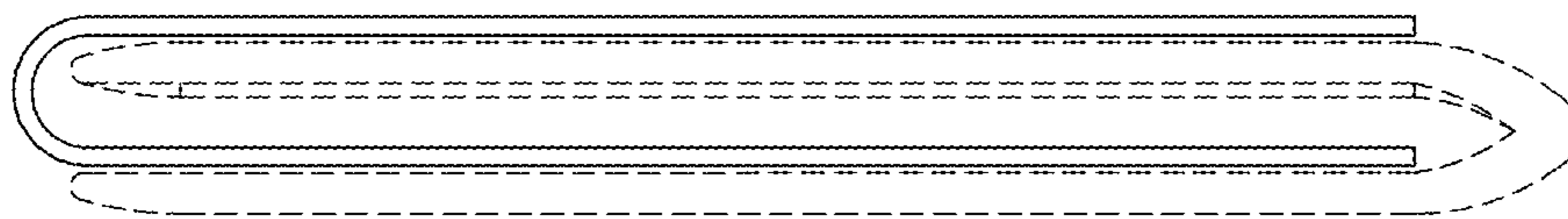

FIG. 8

