

US00D797423S

(12) **United States Design Patent**
Bischoff et al.

(10) **Patent No.:** **US D797,423 S**
(45) **Date of Patent:** **** Sep. 19, 2017**

- (54) **SHOE**
- (71) Applicant: **Reebok International Limited**, London (GB)
- (72) Inventors: **Robert Bischoff**, Attleboro, MA (US); **Matthew Boudreau**, North Attleboro, MA (US)
- (73) Assignee: **Reebok International Limited**, London (GB)
- (**) Term: **15 Years**
- (21) Appl. No.: **29/544,149**

3,793,750 A	2/1974	Bowerman
D241,688 S	10/1976	Johnson
D254,818 S	4/1980	Jones
4,271,606 A	6/1981	Rudy
4,309,831 A	1/1982	Pritt
4,378,643 A	4/1983	Johnson
4,439,936 A	4/1984	Clarke et al.
D284,616 S *	7/1986	Gamm D2/954
D288,621 S	3/1987	Surpuriya et al.
D297,383 S	8/1988	Mourad et al.
D299,681 S	2/1989	Miller et al.
D301,184 S	5/1989	Hase
D301,800 S	6/1989	Mitsui
D321,973 S	12/1991	Hatfield
D335,572 S	5/1993	Peterson
D390,348 S	2/1998	Meyer et al.
D395,340 S	6/1998	Tresser

(Continued)

- (22) Filed: **Oct. 30, 2015**
- (51) **LOC (10) Cl.** **02-04**
- (52) **U.S. Cl.**
USPC **D2/960**; D2/951; D2/957; D2/959
- (58) **Field of Classification Search**
USPC D2/902, 906, 908, 916, 918, 925,
D2/946-962, 977; 36/3 B, 22 R, 24.5,
36/25 R, 28, 32 R, 34 R, 59 C, 67 A, 103
CPC A43B 13/00; A43B 13/02; A43B 13/023;
A43B 13/026; A43B 13/04; A43B 13/08;
A43B 13/10; A43B 13/12; A43B 13/14;
A43B 13/141; A43B 13/143; A43B
13/16; A43B 13/18; A43B 13/181; A43B
13/187; A43B 13/189; A43B 13/20; A43B
13/22; A43B 13/223; A43B 13/24; A43B
13/28; A43B 13/30; A43B 13/32; A43B
13/34; A43B 13/36
See application file for complete search history.

(56) **References Cited**
U.S. PATENT DOCUMENTS

D29,749 S	11/1898	Bunker
2,853,809 A	9/1958	Bianchi
D196,491 S	10/1963	Papoutsy
3,416,174 A	12/1968	Novitske

OTHER PUBLICATIONS

U.S. Appl. No. 29/544,150, filed Oct. 30, 2015; Bischoff et al.

Primary Examiner — T. Chase Nelson
(74) *Attorney, Agent, or Firm* — Sterne, Keesler,
Goldstein & Fox P.L.L.C.

(57) **CLAIM**

The ornamental design for a shoe, as shown and described.

DESCRIPTION

FIG. 1 is a bottom perspective view of a shoe showing the claimed design;
FIG. 2 is a top plan view thereof;
FIG. 3 is a bottom plan view thereof;
FIG. 4 is a side view thereof;
FIG. 5 is another side view thereof;
FIG. 6 is a front view thereof; and,
FIG. 7 is a rear view thereof.
The broken lines in the figures show portions of the shoe that form no part of the claimed design.

1 Claim, 6 Drawing Sheets

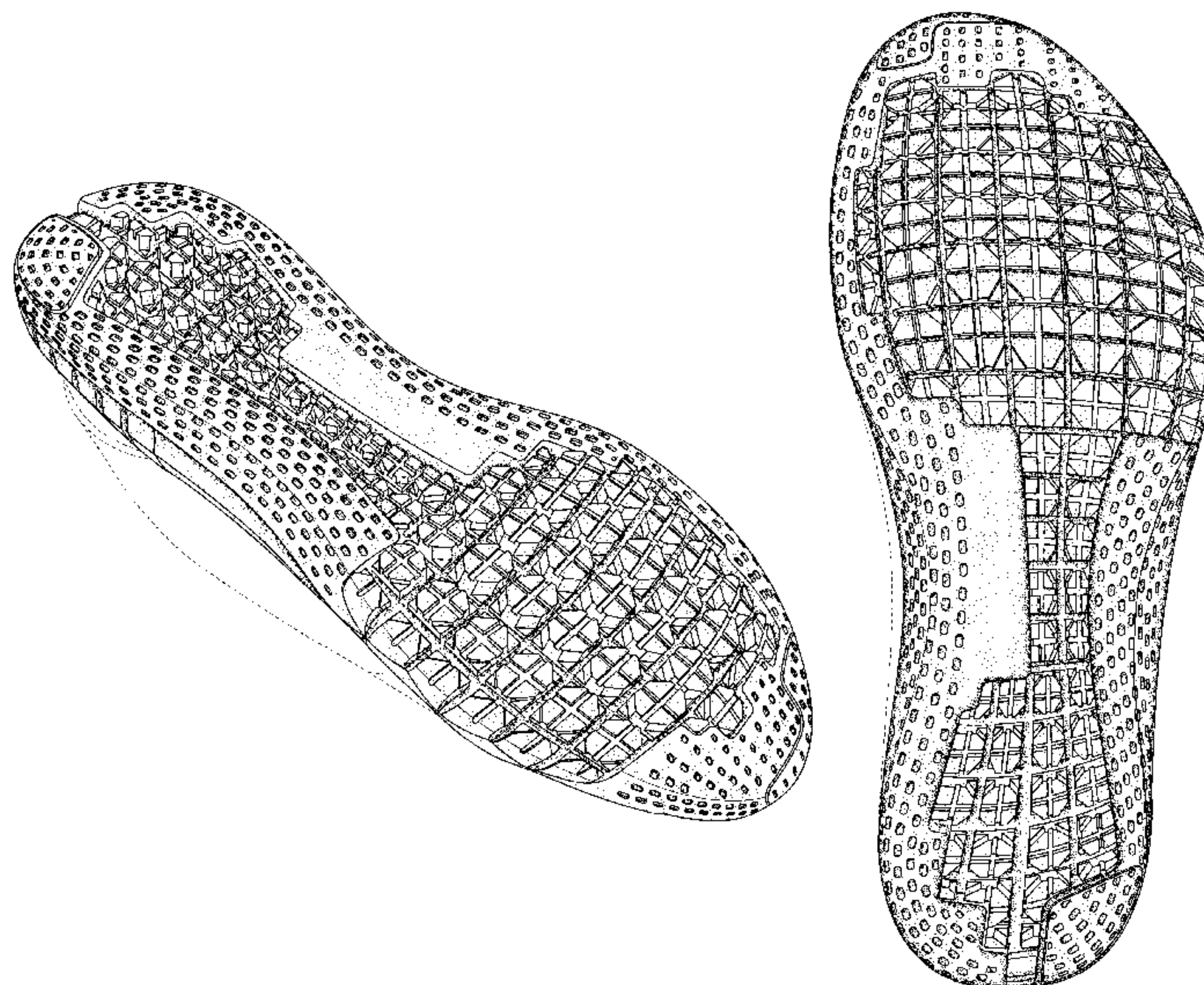

(56)

References Cited

U.S. PATENT DOCUMENTS

D395,740 S 7/1998 Cass
 D397,546 S 9/1998 Merceron
 D400,345 S 11/1998 Teaque
 D401,745 S 12/1998 Greenberg
 D404,897 S 2/1999 Marshall
 5,985,383 A 11/1999 Allen et al.
 D432,763 S 10/2000 Smith, III
 D433,215 S 11/2000 Smith, III
 6,195,918 B1* 3/2001 Kelley A43B 1/0027
 36/107
 D442,768 S 5/2001 Matis
 D458,441 S 6/2002 Gillespie
 D474,586 S* 5/2003 Recchi D2/951
 6,665,958 B2 12/2003 Goodwin
 D497,707 S 11/2004 Lee
 D536,163 S 2/2007 McClaskie
 D538,519 S 3/2007 McClaskie
 D556,988 S 12/2007 Horne et al.
 D561,438 S 2/2008 Belley
 D561,439 S 2/2008 Schoenborn et al.
 D569,591 S* 5/2008 Teteriatnikov D2/952
 7,383,647 B2 6/2008 Chan et al.
 7,704,430 B2 4/2010 Johnson et al.
 D634,526 S* 3/2011 Ng D2/953
 D657,941 S* 4/2012 Bramani D2/902
 8,191,284 B2 6/2012 Cho
 D664,748 S* 8/2012 Lubart D2/923
 D666,394 S* 9/2012 Mentha D2/951
 D671,305 S* 11/2012 Escobar D2/947
 D672,949 S 12/2012 Bramani et al.
 D686,402 S 7/2013 Portzline
 D687,622 S* 8/2013 Tzenos D2/923
 D695,502 S 12/2013 Miner
 D696,505 S 12/2013 Miner
 D697,294 S 1/2014 Miner
 D697,296 S* 1/2014 Loyley D2/951
 D702,428 S 4/2014 Hlavacs
 D703,425 S 4/2014 Lee
 D707,933 S 7/2014 McCourt
 D709,274 S 7/2014 Roulo

D711,637 S 8/2014 Miner
 D713,628 S 9/2014 Greenspan
 D722,425 S* 2/2015 Cin D2/947
 D727,002 S* 4/2015 Sassi D2/944
 D737,558 S* 9/2015 Bizzo D2/951
 D740,529 S* 10/2015 Bikowski D2/951
 9,179,738 B2* 11/2015 Rustam A43B 7/1425
 D744,212 S 12/2015 Boudreau et al.
 D744,728 S* 12/2015 Remmele D2/908
 D748,385 S* 2/2016 Birkinhead D2/951
 D749,310 S* 2/2016 Greenhalgh D2/951
 D753,376 S* 4/2016 Birkinhead D2/902
 D755,490 S* 5/2016 Nakano D2/951
 D768,368 S* 10/2016 Birkinhead D2/953
 D772,541 S* 11/2016 Sassi D2/902
 9,491,985 B2* 11/2016 Lubart A43B 13/22
 D779,181 S* 2/2017 Sassi D2/957
 D779,182 S* 2/2017 Hobson D2/960
 D787,169 S* 5/2017 Sassi D2/947
 2002/0078598 A1 6/2002 Bell
 2006/0201028 A1 9/2006 Chan et al.
 2009/0139112 A1 6/2009 Garneau
 2009/0183392 A1 7/2009 Shane
 2010/0170106 A1 7/2010 Brewer et al.
 2010/0251565 A1 10/2010 Litchfield et al.
 2011/0099855 A1 5/2011 Cho
 2011/0258883 A1* 10/2011 Eder A43B 5/02
 36/133
 2012/0180335 A1 7/2012 Mahoney
 2014/0115925 A1* 5/2014 Hurd A43B 13/122
 36/103
 2014/0150297 A1 6/2014 Holmes et al.
 2014/0259789 A1 9/2014 Dojan et al.
 2014/0759788 9/2014 Dojan et al.
 2014/0310991 A1 10/2014 Greene et al.
 2015/0033577 A1 2/2015 Dahl et al.
 2015/0342300 A1* 12/2015 Cin A43B 17/003
 36/103
 2016/0353836 A1* 12/2016 Luedecke A43B 13/122
 2017/0079373 A1* 3/2017 Huard A43B 13/127
 2017/0119091 A1* 5/2017 Bischoff A43B 13/186

* cited by examiner

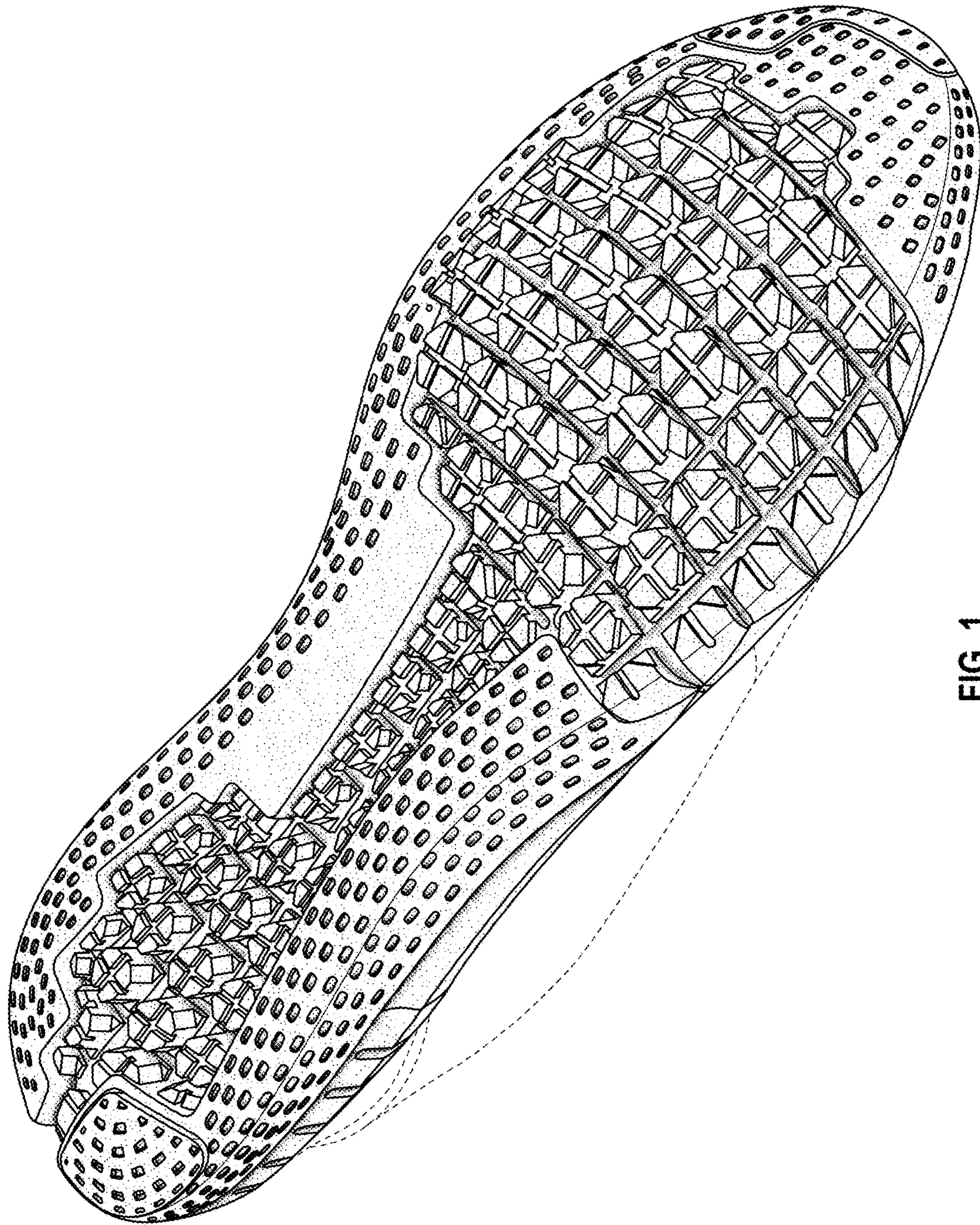

FIG. 1

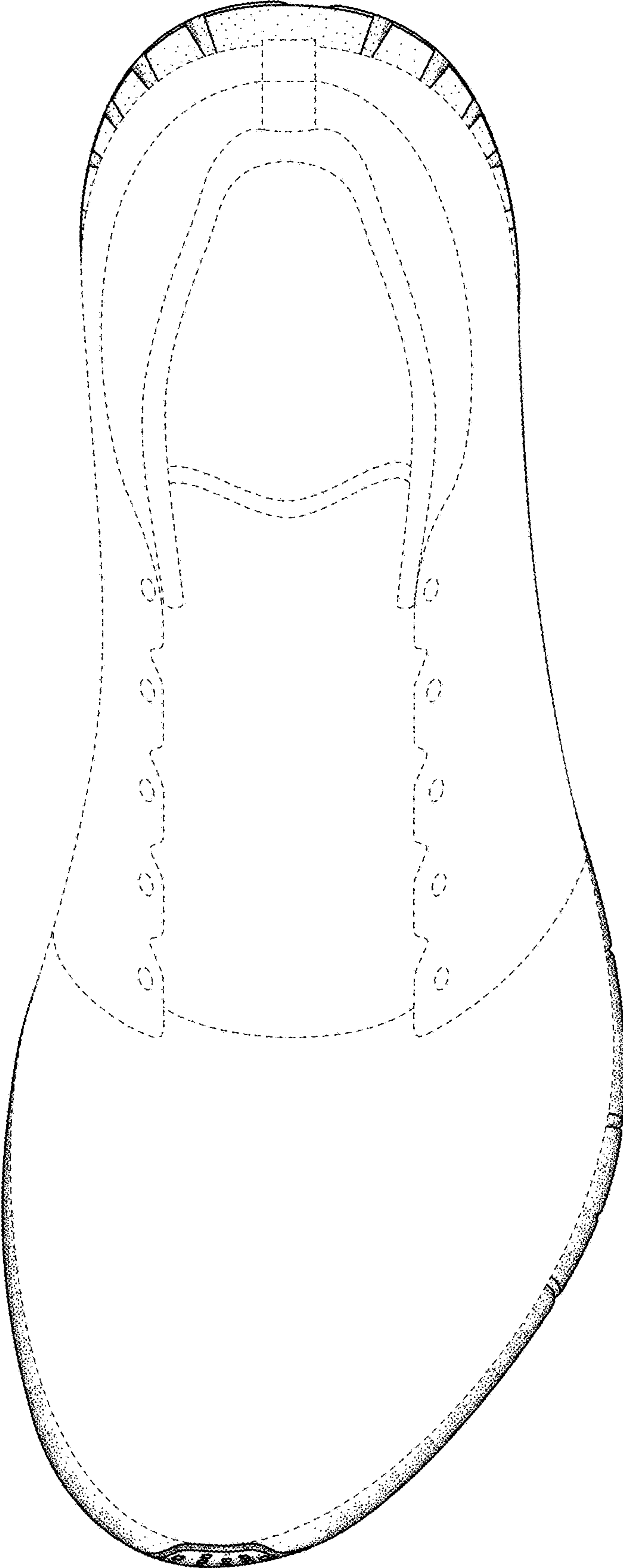

FIG. 2

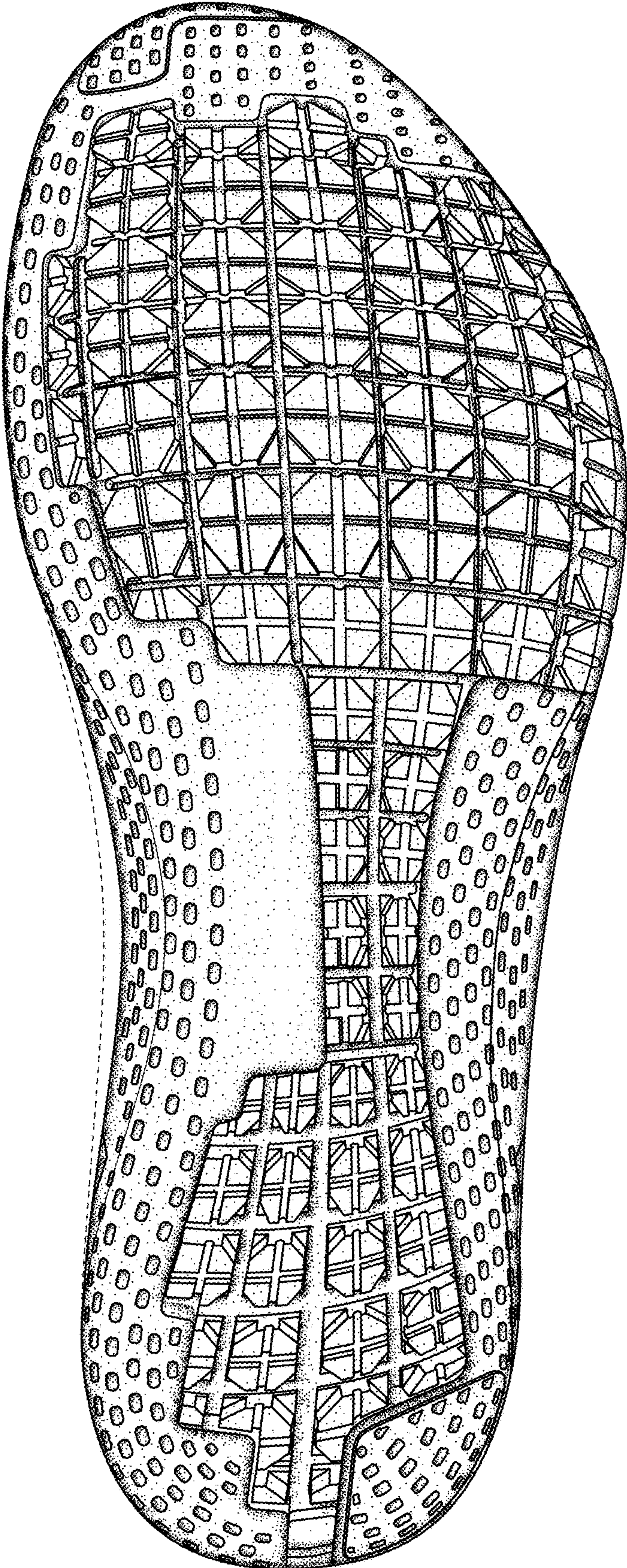

FIG. 3

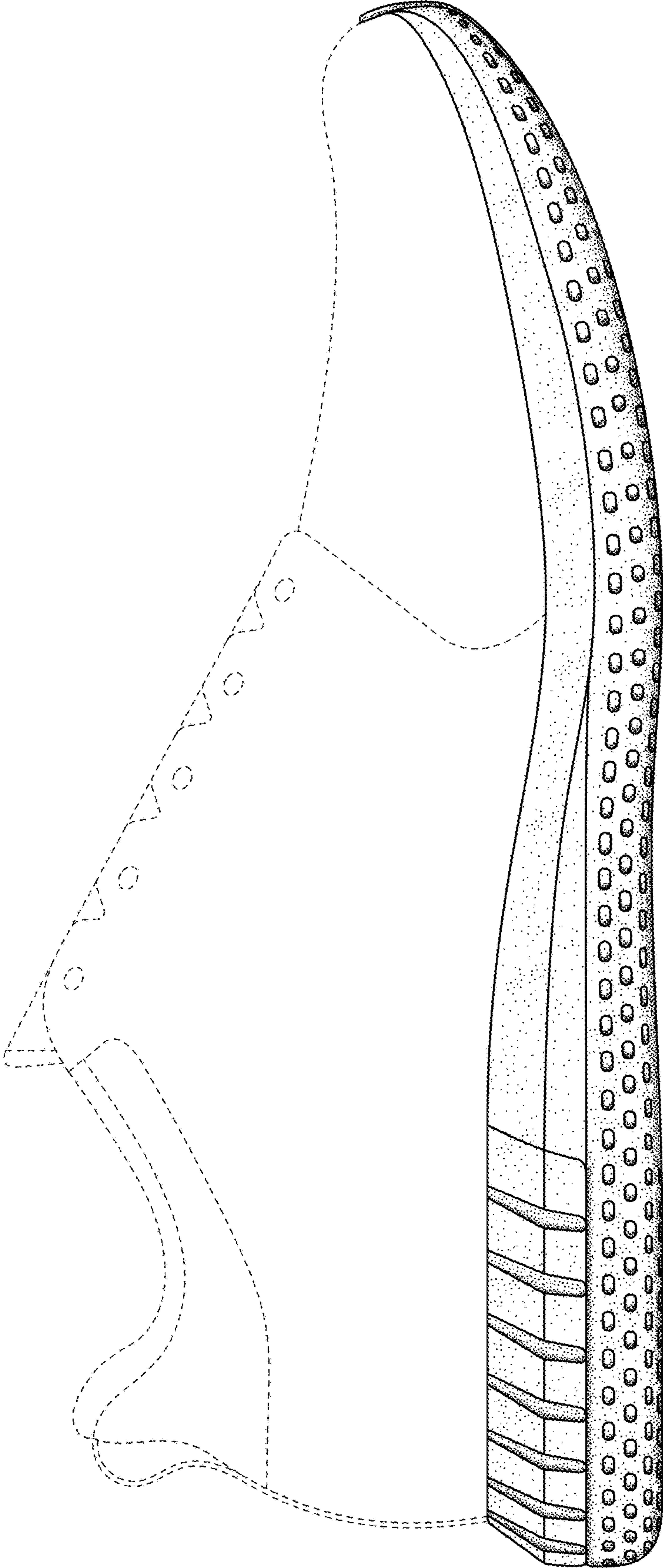

FIG. 4

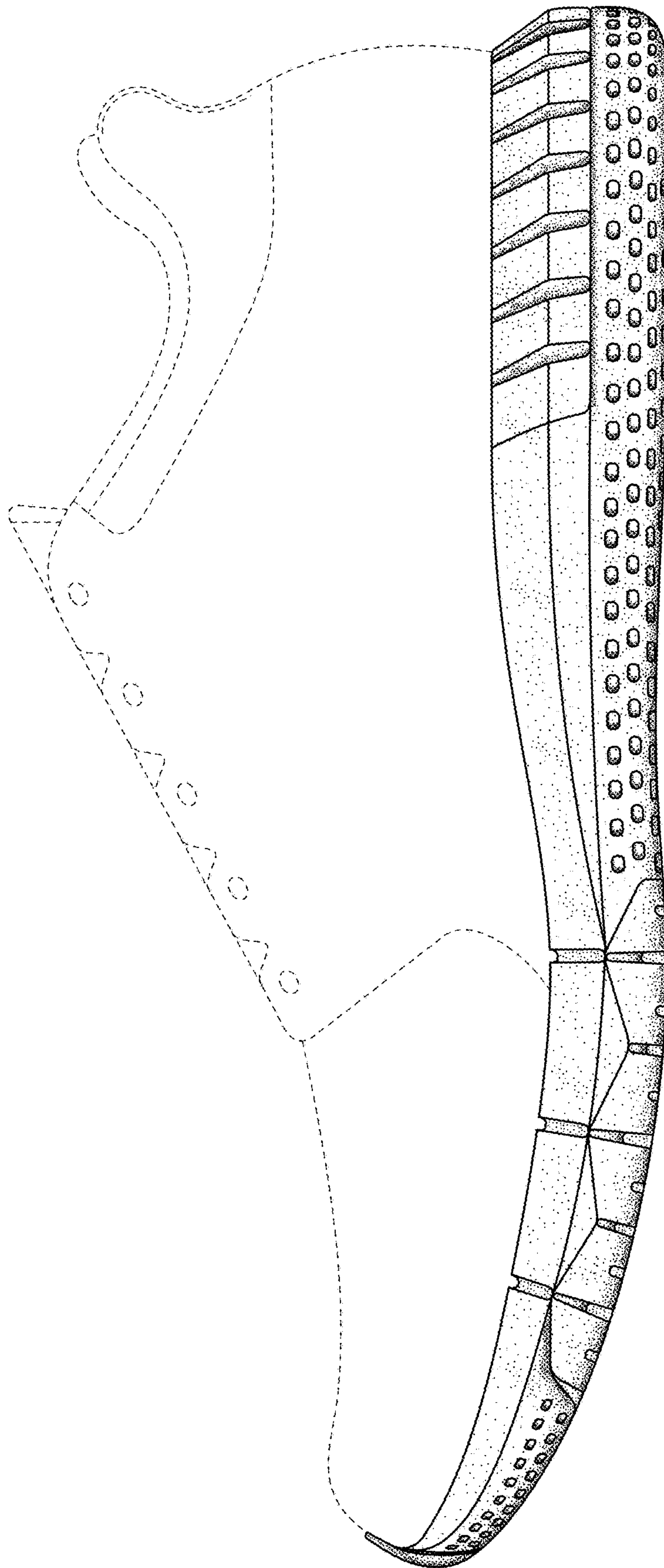

FIG. 5

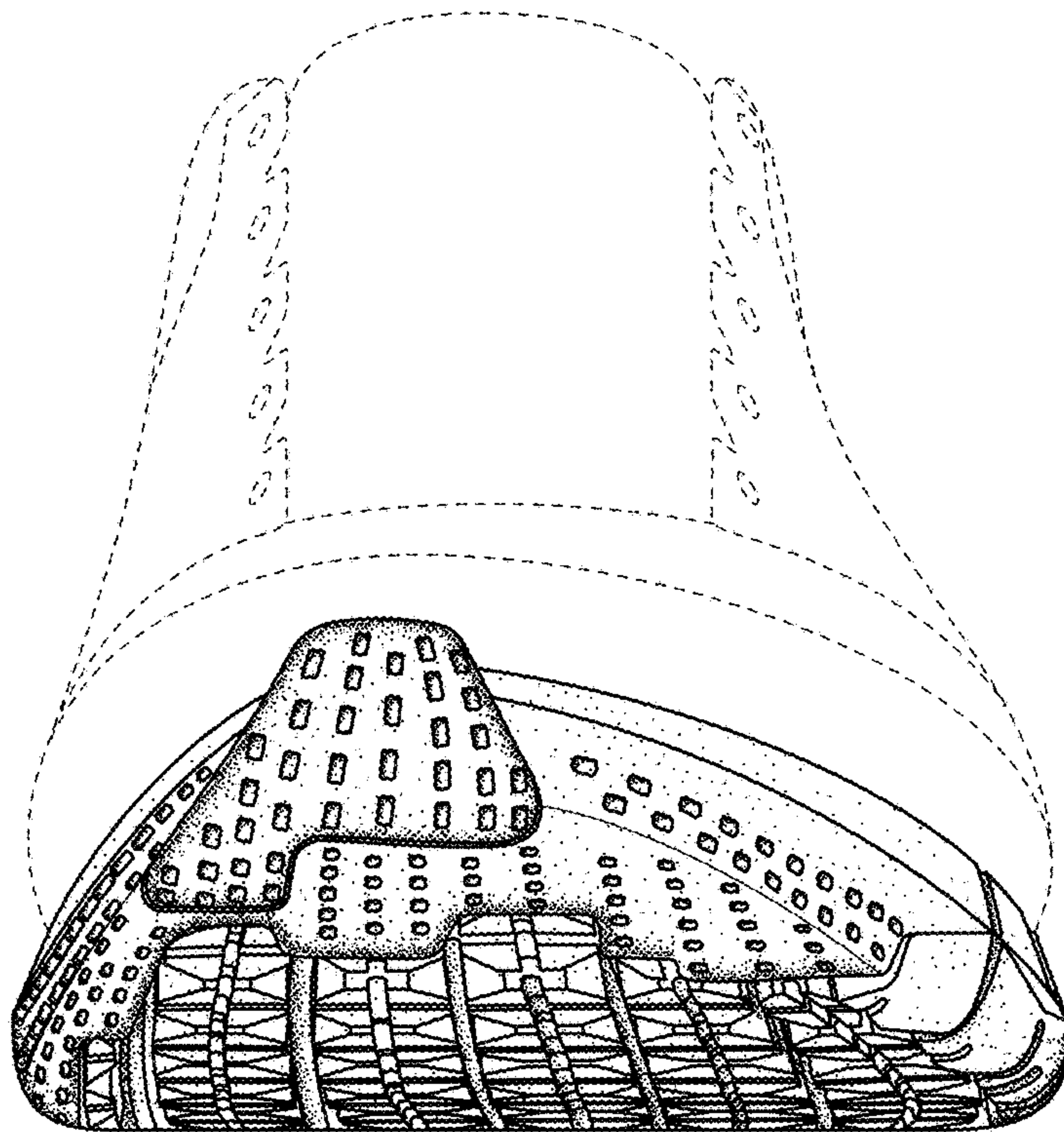

FIG. 6

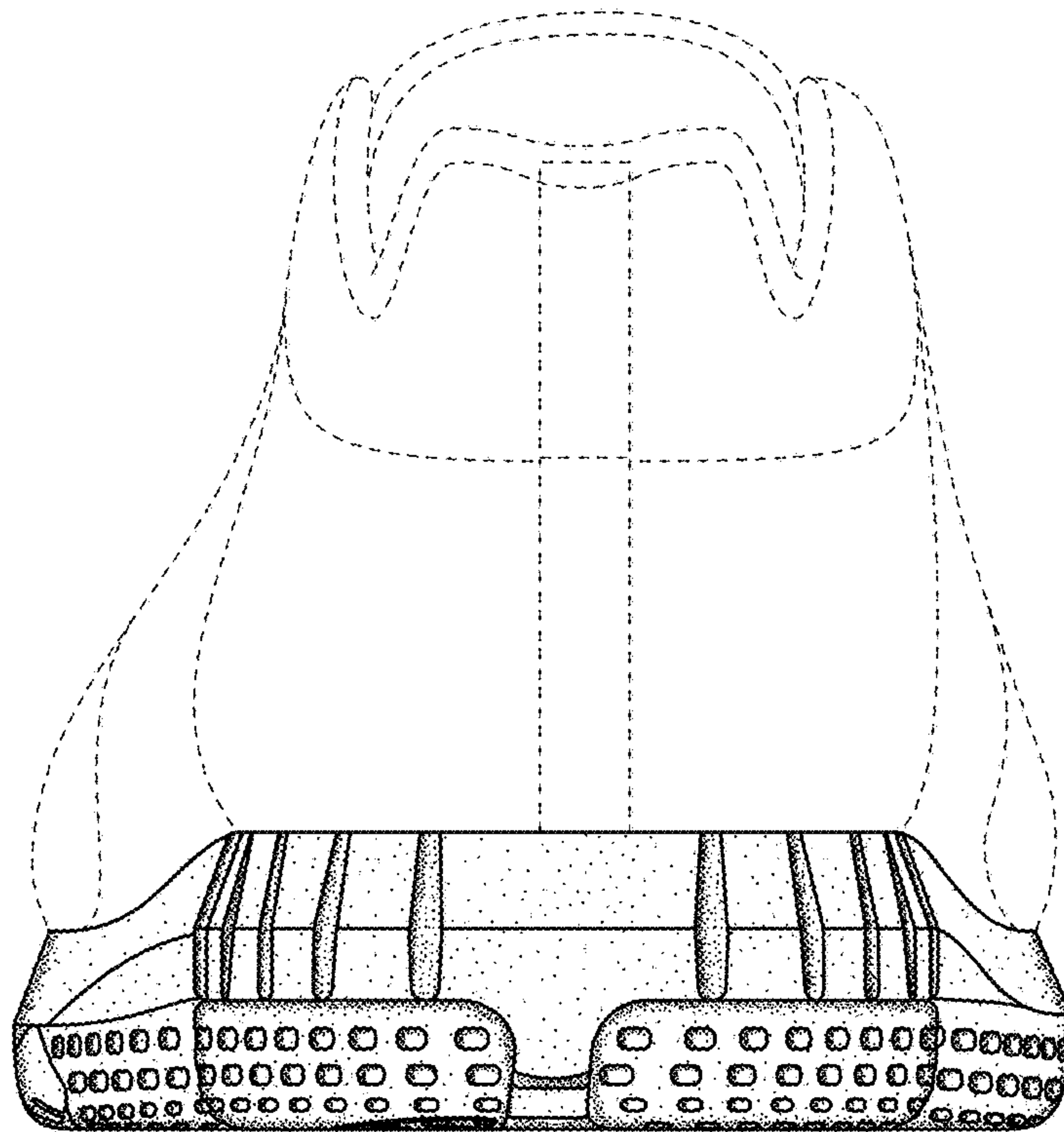

FIG. 7