



US00D797354S

(12) **United States Design Patent**
Sonneman

(10) **Patent No.:** **US D797,354 S**

(45) **Date of Patent:** **** Sep. 12, 2017**

(54) **PENDANTS FOR LIGHT FIXTURES**

(71) Applicant: **Robert A. Sonneman**, Mamaroneck,
NY (US)

(72) Inventor: **Robert A. Sonneman**, Mamaroneck,
NY (US)

(**) Term: **15 Years**

(21) Appl. No.: **29/598,222**

(22) Filed: **Mar. 23, 2017**

D576,339 S	9/2008	Porter	
D588,297 S	3/2009	Rubin	
D588,301 S	3/2009	Sabernig	
D596,335 S *	7/2009	Sabernig	D26/88
D625,457 S	10/2010	Sonneman	
D627,502 S	11/2010	Zheng	
D630,365 S	1/2011	Sabernig	
D659,883 S	5/2012	Herremans	
D659,884 S *	5/2012	Sabernig	D26/84
D660,504 S	5/2012	Martin	
D669,621 S	10/2012	Sabernig	
D671,670 S	11/2012	Sonneman	
D715,479 S *	10/2014	Johnston	D26/113
D715,986 S	10/2014	Anastassiades	
D730,651 S	6/2015	Perego	
D731,694 S *	6/2015	Tomlinson	D26/128

(Continued)

Related U.S. Application Data

(62) Division of application No. 29/551,563, filed on Jan. 14, 2016, now Pat. No. Des. 787,109.

(51) **LOC (10) Cl.** **26-99**

(52) **U.S. Cl.**
USPC **D26/118; D26/128**

(58) **Field of Classification Search**
USPC D26/81-91, 118, 128, 113, 120, 122,
D26/123, 130, 137, 72, 80
CPC F21S 8/04; F21S 8/043; F21S 8/046; F21S
8/06; F21S 8/061; F21S 8/063; F21S
8/065

See application file for complete search history.

(56) **References Cited**

U.S. PATENT DOCUMENTS

D89,305 S *	2/1933	Hale	D26/88
D105,531 S *	8/1937	Korengold	D26/128
D317,058 S	5/1991	Sonneman	
D320,465 S *	10/1991	Sonneman	D26/86
D399,330 S *	10/1998	Geier	D26/88
D488,880 S *	4/2004	Rahn	D26/72
D563,022 S *	2/2008	Hetfield	D26/72
D563,590 S *	3/2008	Hetfield	D26/72
D567,988 S	4/2008	Lissoni	
7,354,171 B2	4/2008	Pazula	

Primary Examiner — Brian N Vinson

(74) *Attorney, Agent, or Firm* — Gottlieb, Rackman & Reisman, P.C.

(57) **CLAIM**

The ornamental design for pendants for light fixtures, as shown and described.

DESCRIPTION

FIG. 1 is a perspective of a pendants for light fixtures showing my new design;

FIG. 2 is an enlarged perspective view of a single pendant thereof, the remaining pendants being omitted for clarity of illustration;

FIG. 3 is an enlarged top plan view of FIG. 2;

FIG. 4 is an enlarged front elevational view of FIG. 2, the rear elevational view being a mirror image;

FIG. 5 is an enlarged right side elevational view of FIG. 2, the left side elevational view being a mirror image; and,

FIG. 6 is a bottom plan view of FIG. 2.

The broken lines shown in the drawings are included for the purpose of illustrating portions of the article that form no part of the claimed design.

1 Claim, 2 Drawing Sheets

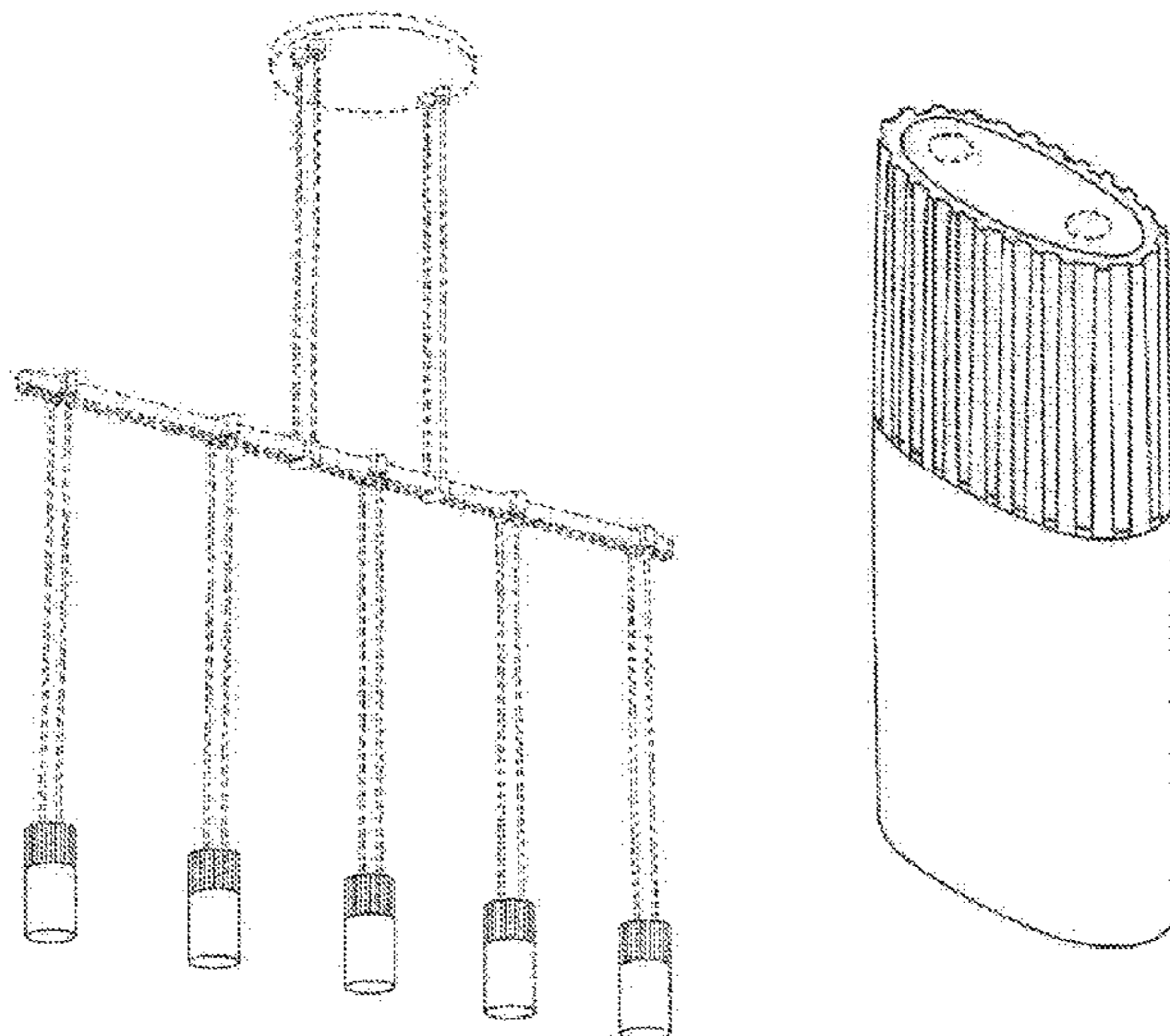

(56)

References Cited

U.S. PATENT DOCUMENTS

D758,637 S	6/2016	Herzog	
D770,667 S	11/2016	Orozco	
D772,467 S	11/2016	Sonneman	
D774,680 S	12/2016	Vidmar	
D790,120 S *	6/2017	Sonneman D26/128

* cited by examiner

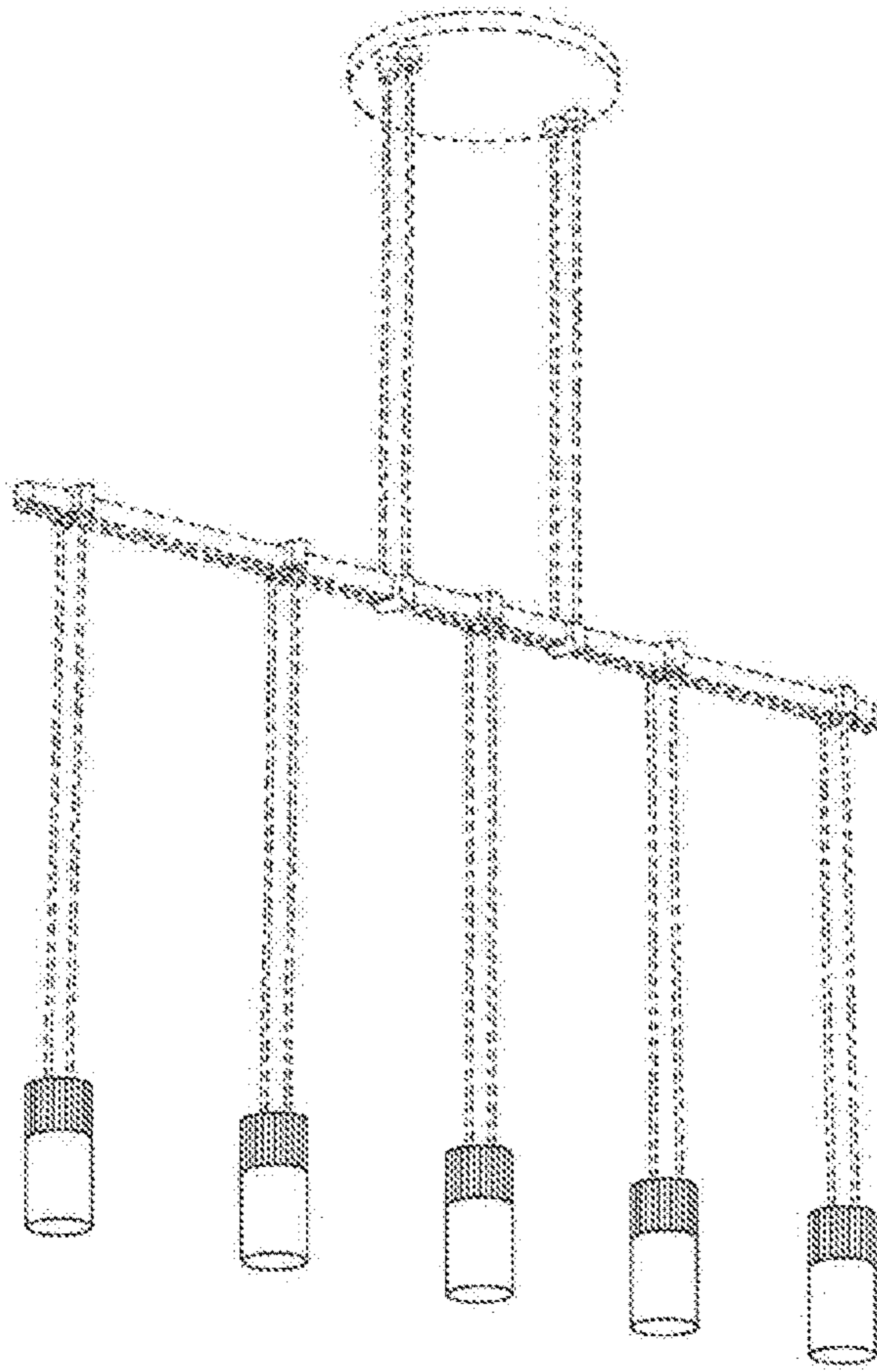

FIG. 1

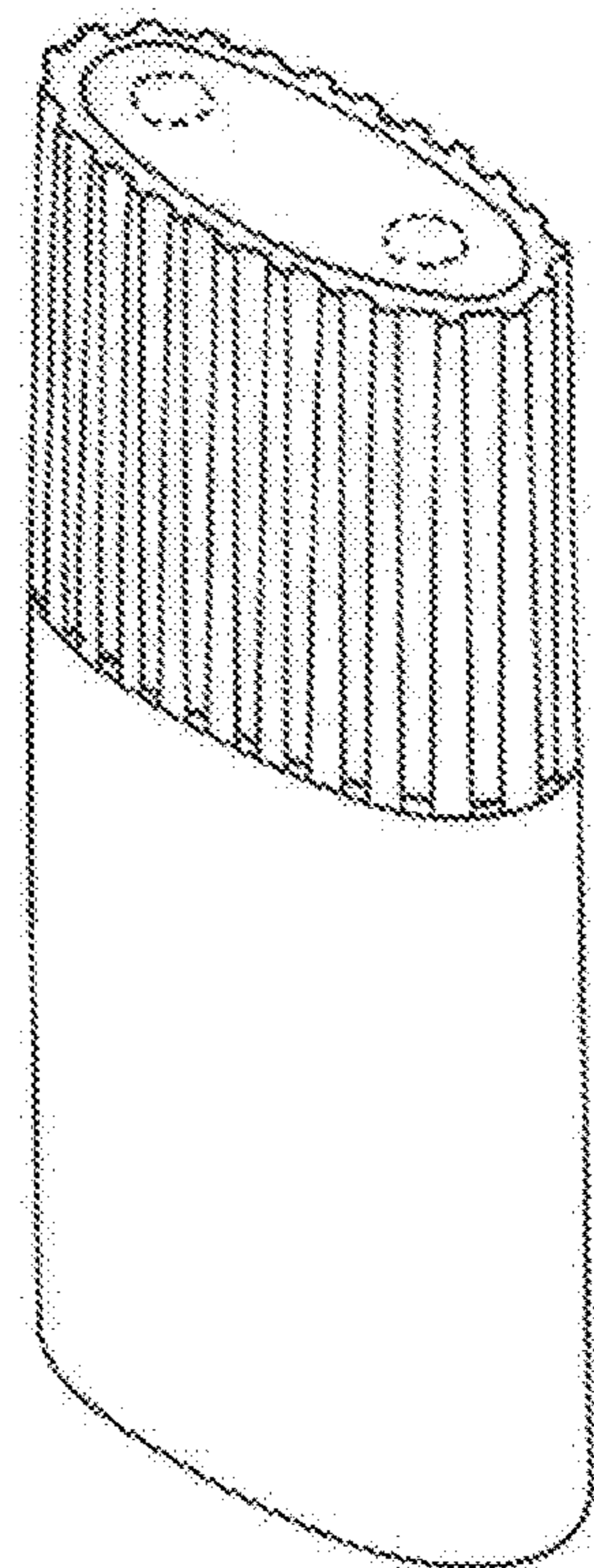

FIG. 2

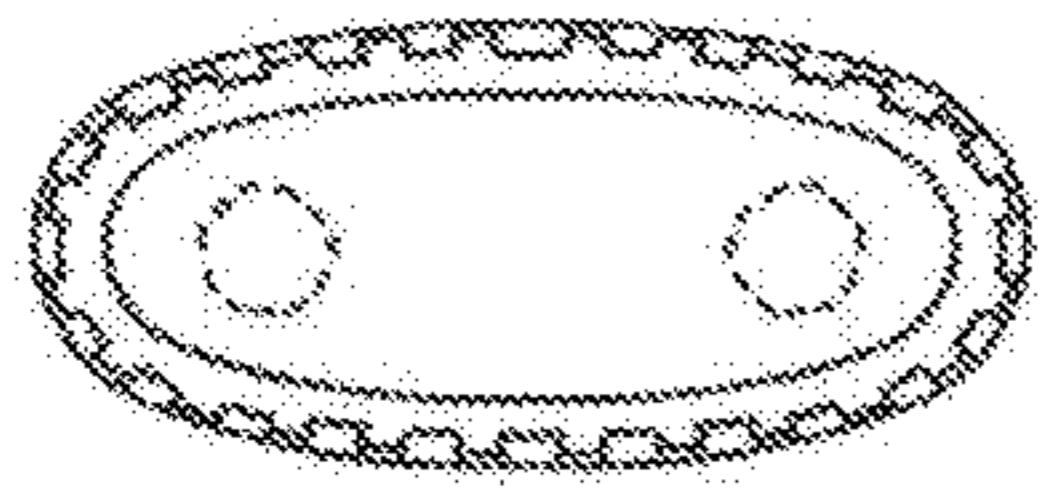

FIG. 3

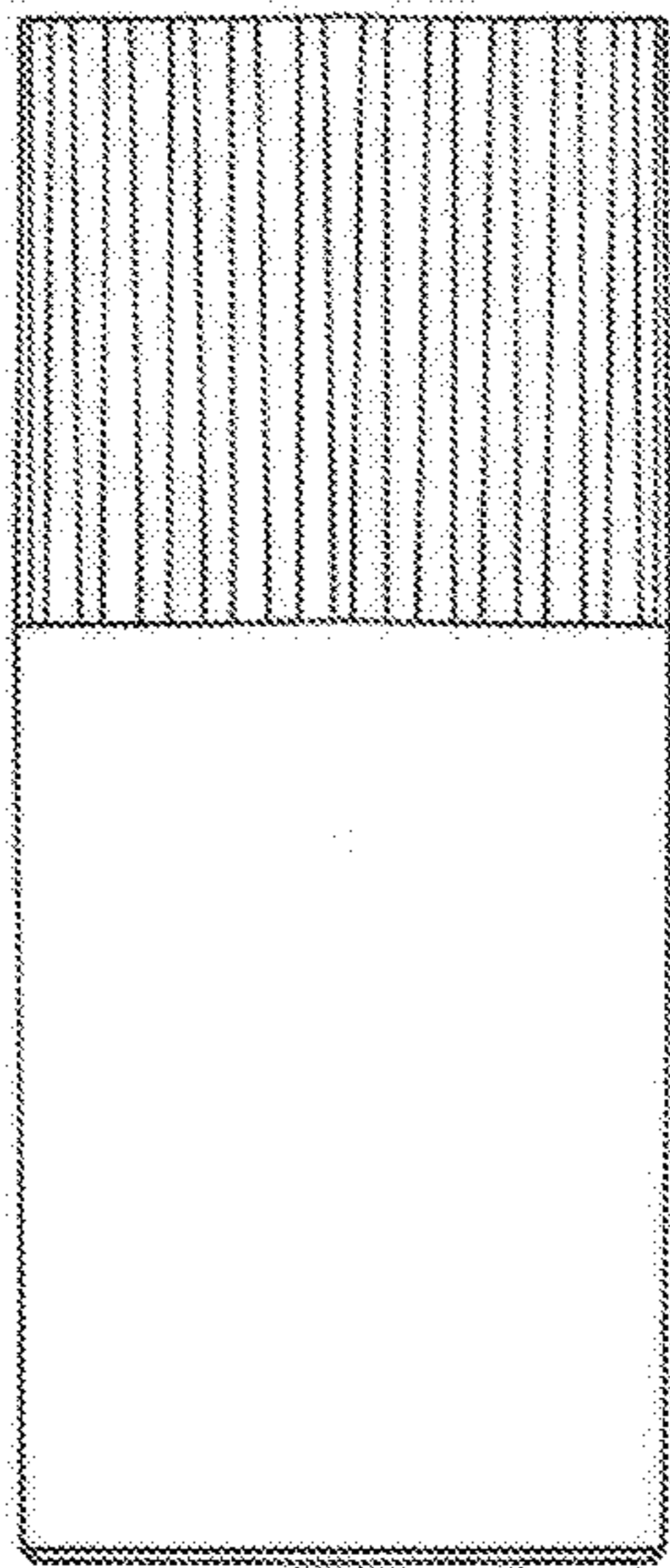

FIG. 4

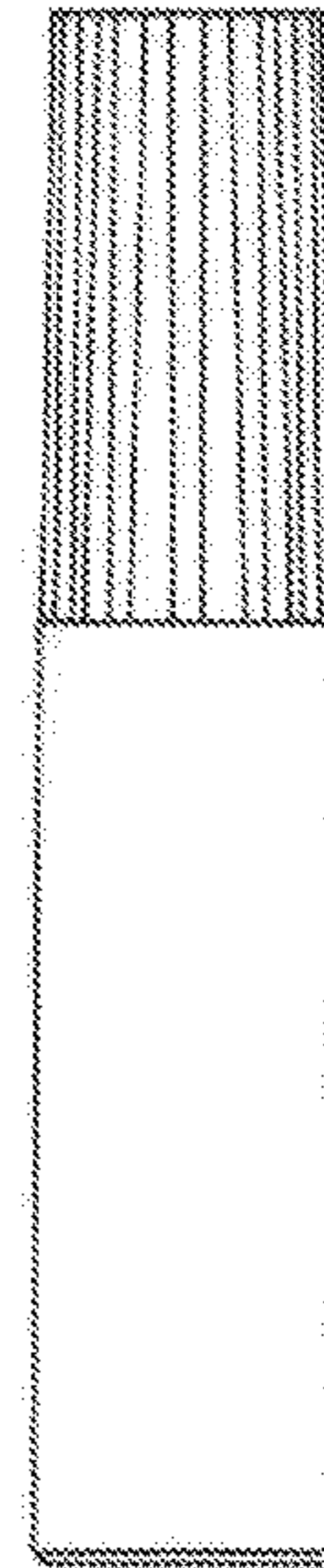

FIG. 5



FIG. 6