



US00D797337S

(12) **United States Design Patent**  
**Dai**

(10) **Patent No.:** **US D797,337 S**

(45) **Date of Patent:** **\*\* Sep. 12, 2017**

(54) **TABLE LAMP**

*Primary Examiner* — Brian N Vinson

(71) Applicant: **Ningbo Weitao Electrical Appliance Co., Ltd.**, Ningbo, Zhejiang (CN)

(57) **CLAIM**

(72) Inventor: **Jiangang Dai**, Zhejiang (CN)

The ornamental design for a table lamp, as shown and described.

(73) Assignee: **NINGBO WEITAO ELECTRICAL APPLIANCE CO., LTD.**, Ningbo (CN)

**DESCRIPTION**

(\*\*) Term: **15 Years**

FIG. 1 is a front elevational view of a table lamp showing my new design;  
FIG. 2 is a rear elevational view thereof;  
FIG. 3 is a left side view thereof;  
FIG. 4 is a right side view thereof;  
FIG. 5 is a top plan view thereof;  
FIG. 6 is a bottom plan view thereof;  
FIG. 7 is a first perspective view thereof;  
FIG. 8 is a second perspective view thereof;  
FIG. 9 is a front elevational view of the table lamp in a first use state;  
FIG. 10 is a rear elevational view of FIG. 9;  
FIG. 11 is a left side view of FIG. 9;  
FIG. 12 is a right side view of FIG. 9;  
FIG. 13 is a top plan view of FIG. 9;  
FIG. 14 is a bottom plan view of FIG. 9;  
FIG. 15 is a perspective view of FIG. 9;  
FIG. 16 is a perspective view of the table lamp in a second use state; and,  
FIG. 17 is a perspective view of the table lamp in a third use state.

(21) Appl. No.: **29/586,278**

(22) Filed: **Dec. 1, 2016**

(51) **LOC (10) Cl.** ..... **26-03**

(52) **U.S. Cl.**  
USPC ..... **D26/63**

(58) **Field of Classification Search**  
USPC ..... D26/1, 24, 63, 61, 93, 106, 107  
CPC .. F21S 6/00; F21S 6/002; F21V 21/14; F21V 21/00; F21V 21/06; F21V 21/30; F21W 2131/30

See application file for complete search history.

(56) **References Cited**

**U.S. PATENT DOCUMENTS**

D563,583 S *	3/2008	Iai	.....	D26/65
D637,332 S *	5/2011	Lee	.....	D26/63
D641,515 S *	7/2011	Chung	.....	D26/63
D665,938 S *	8/2012	Kim	.....	D26/63
D739,976 S *	9/2015	Wu	.....	D26/63
D765,900 S *	9/2016	Oh	.....	D26/63

\* cited by examiner

**1 Claim, 17 Drawing Sheets**

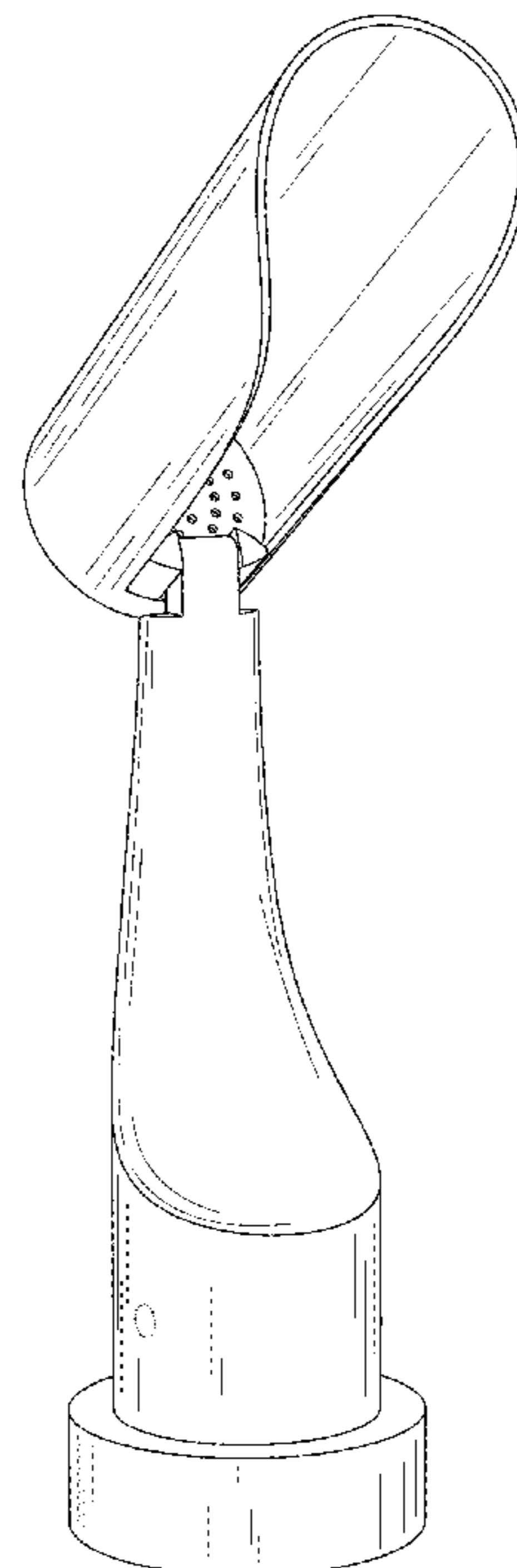
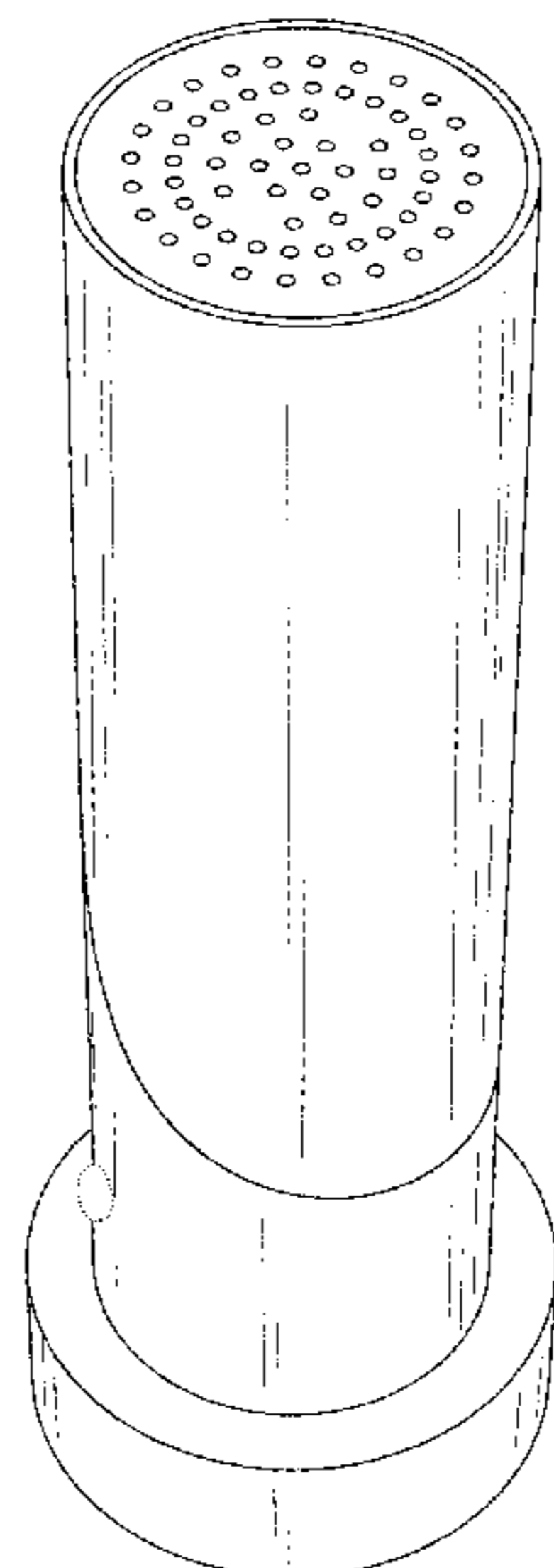

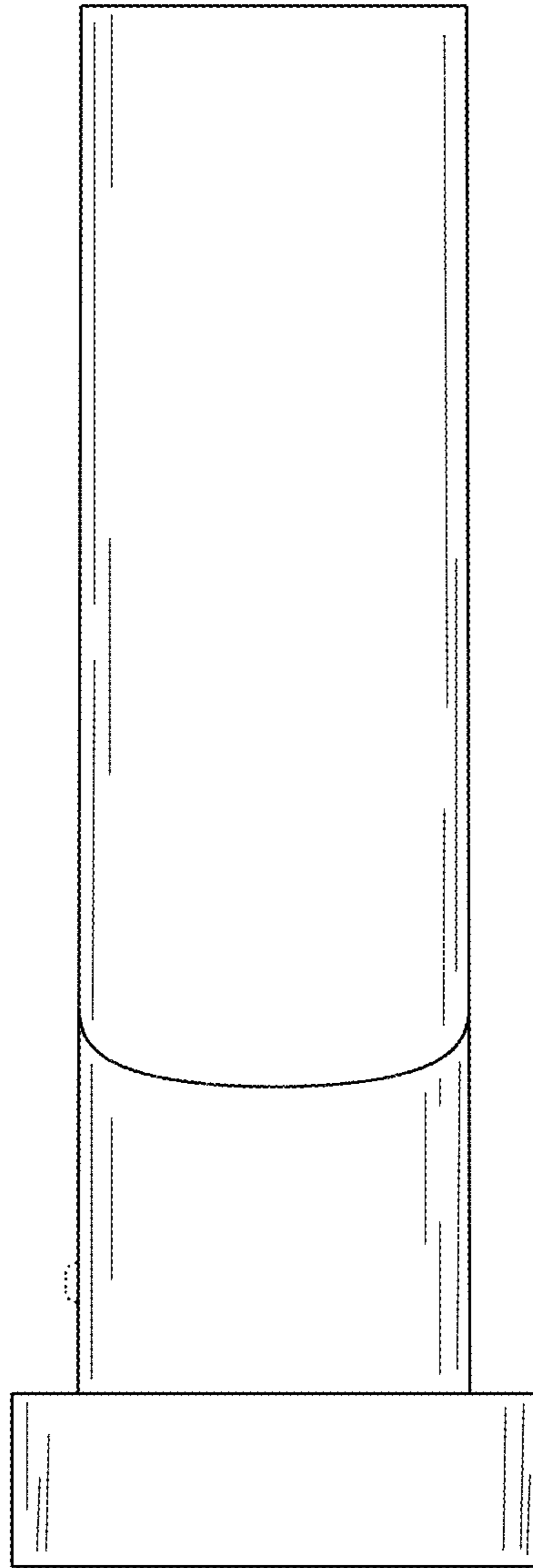

Fig. 1

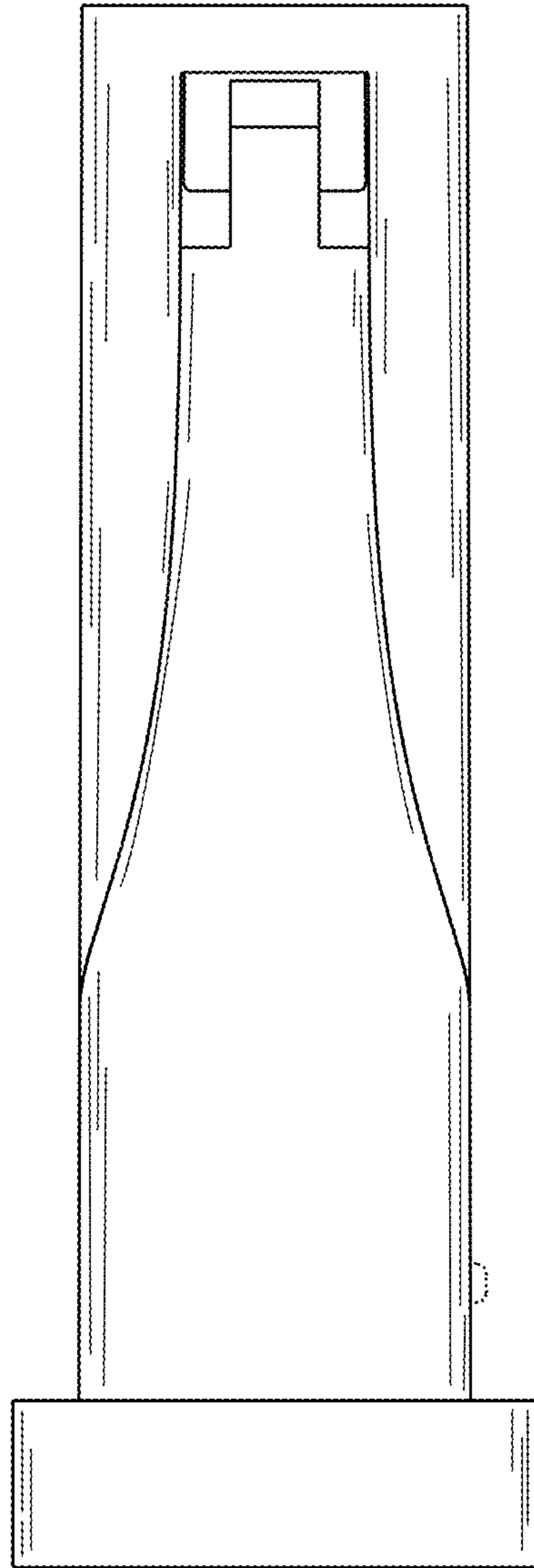

Fig. 2

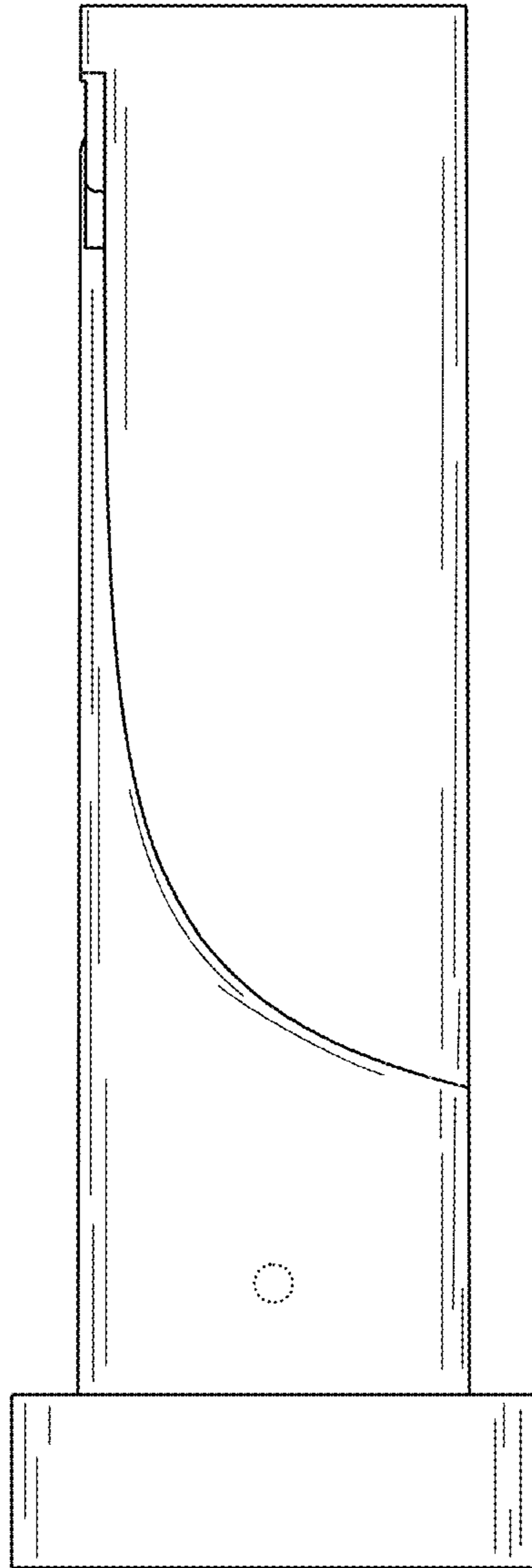

Fig. 3

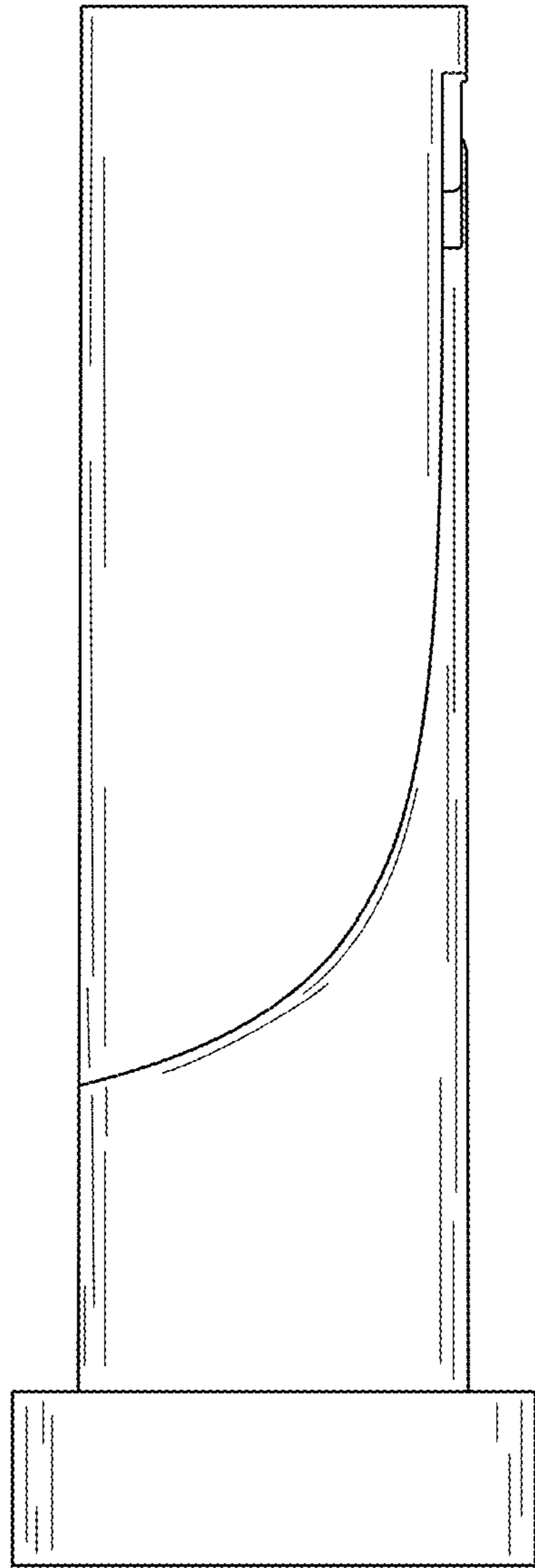

Fig. 4

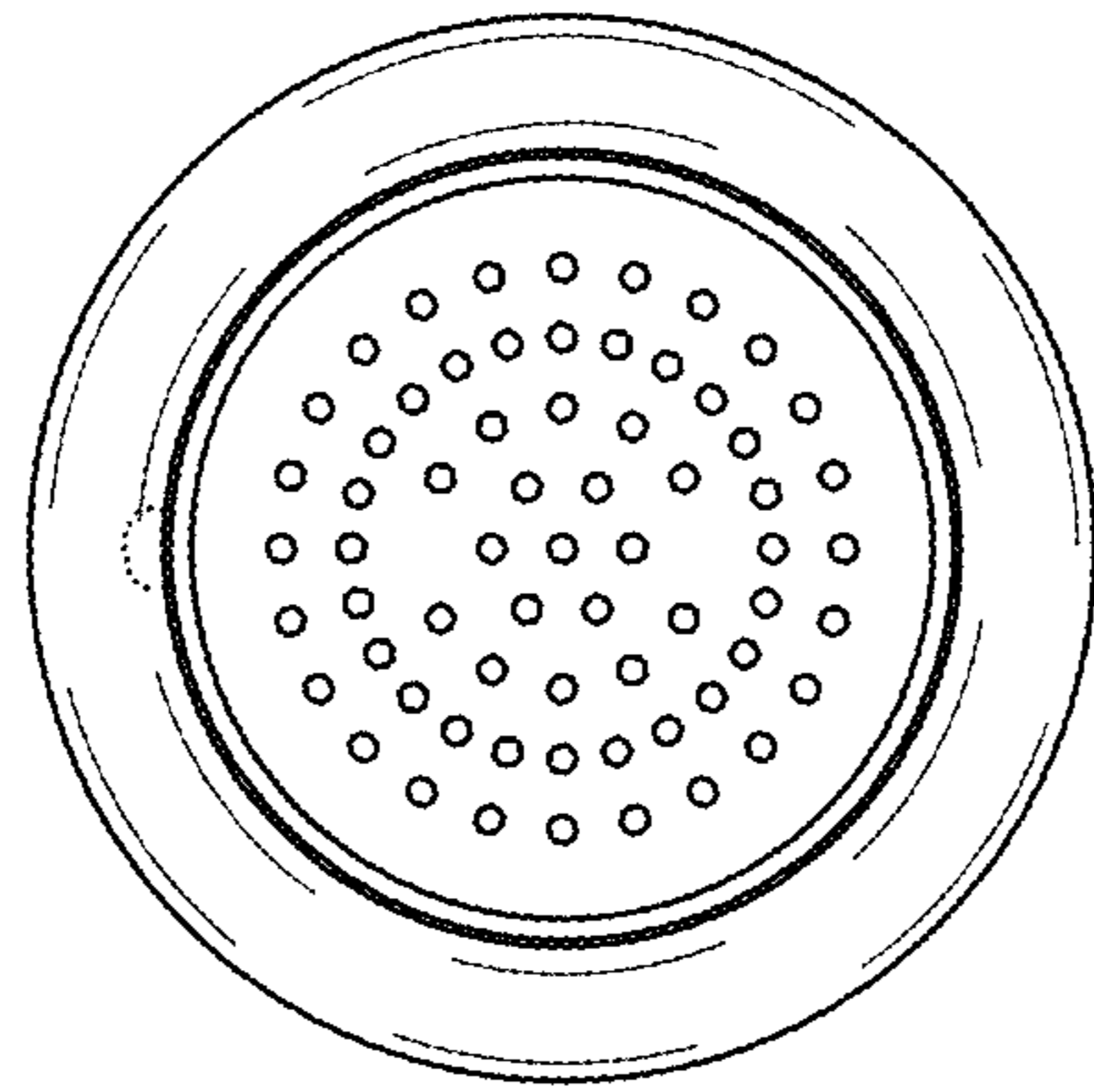

Fig. 5

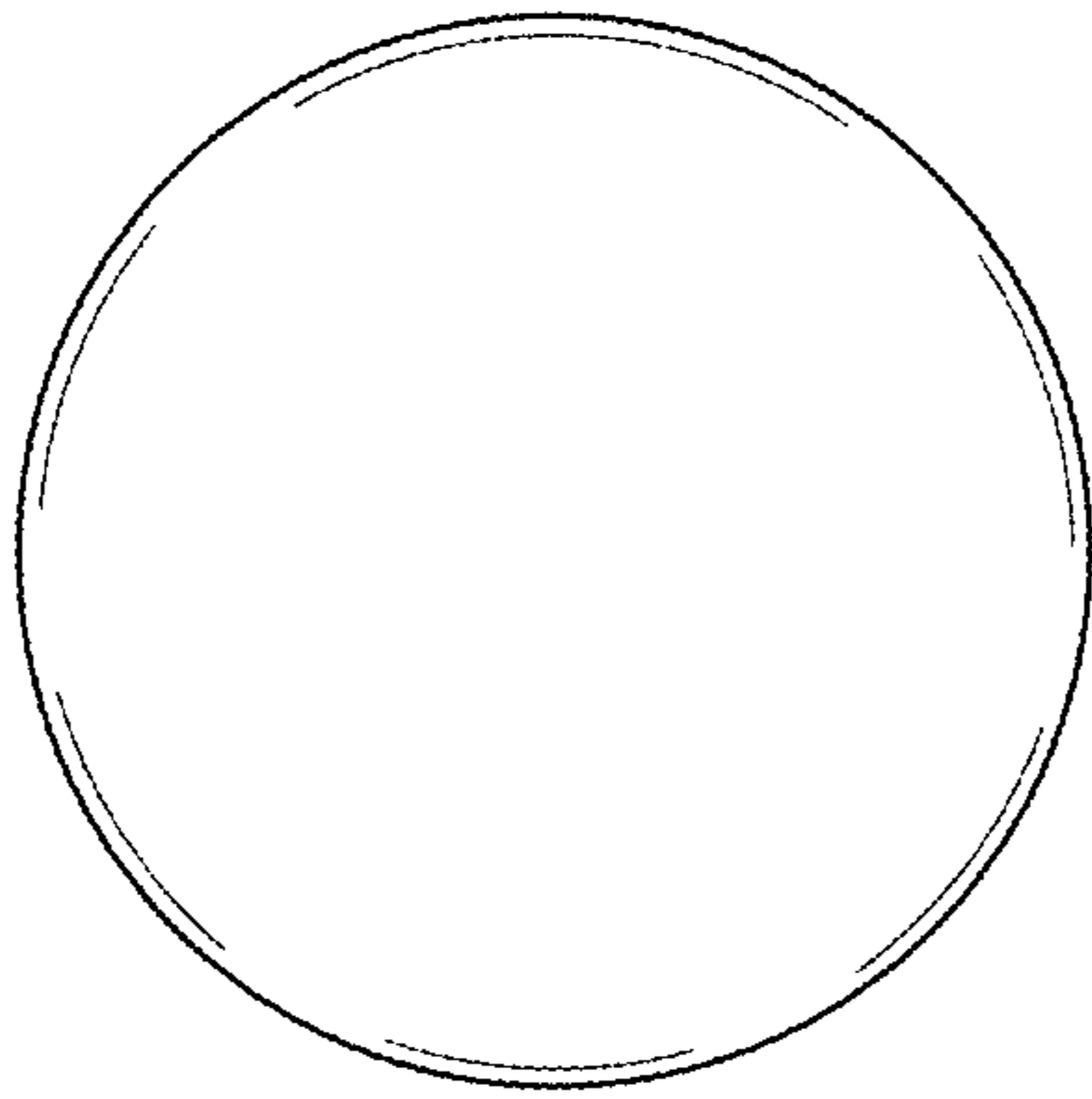

Fig. 6

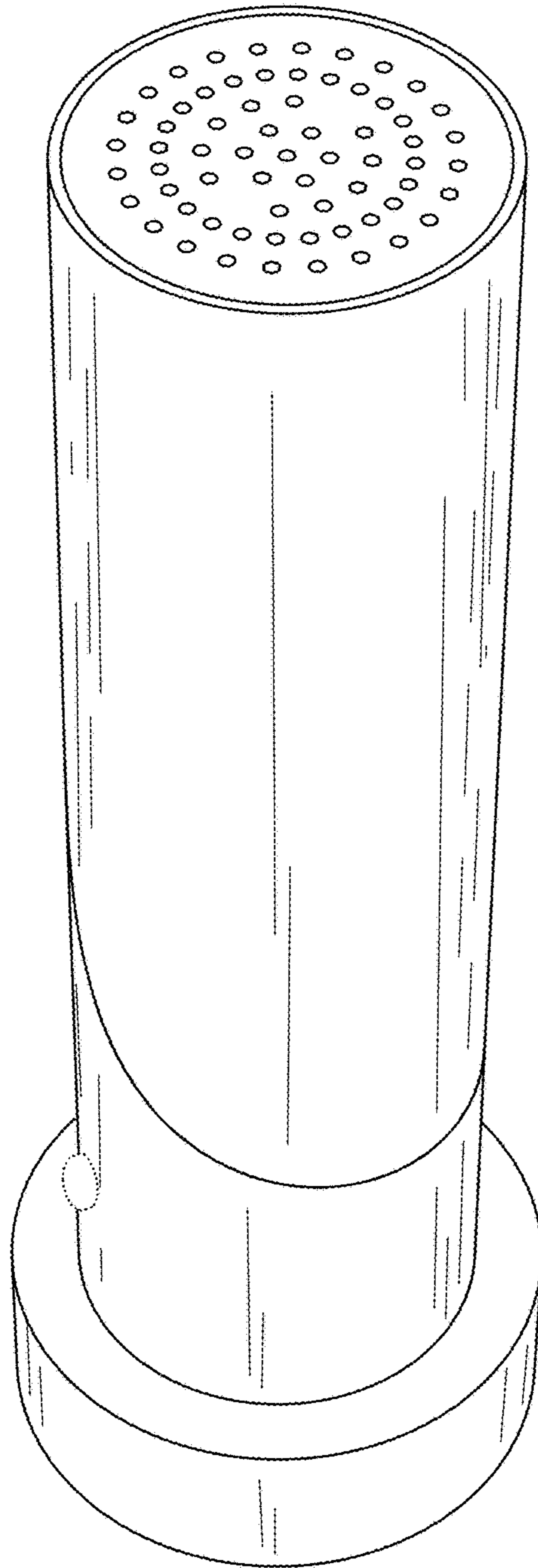

Fig. 7



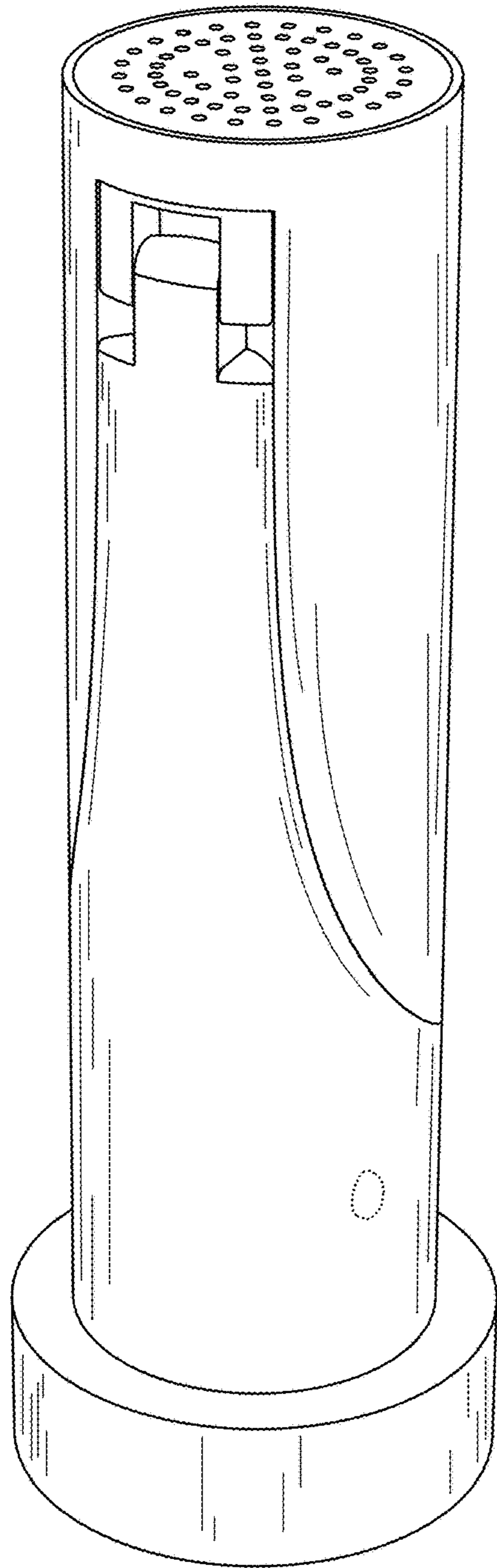

Fig. 8

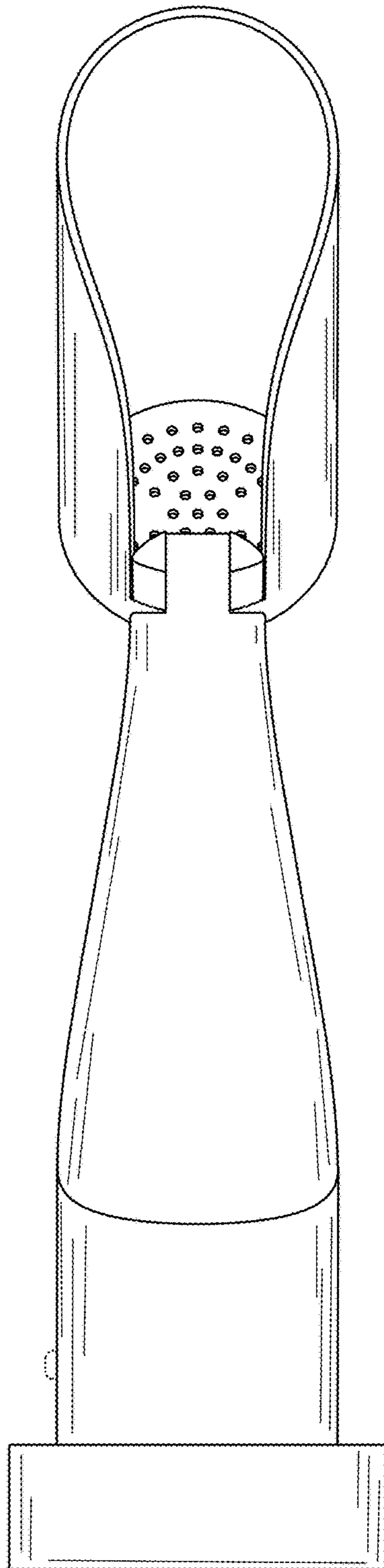

Fig. 9

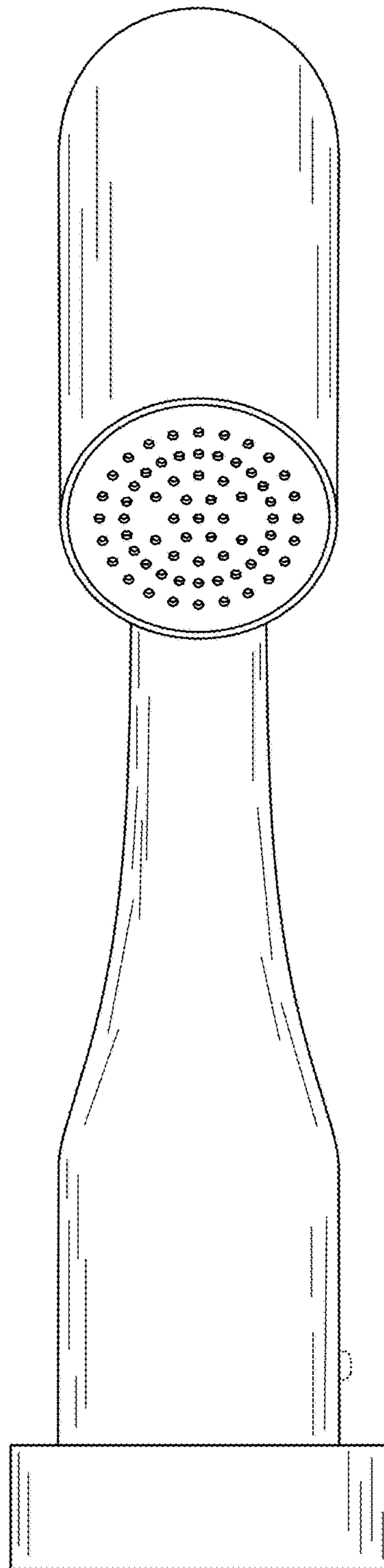

Fig. 10

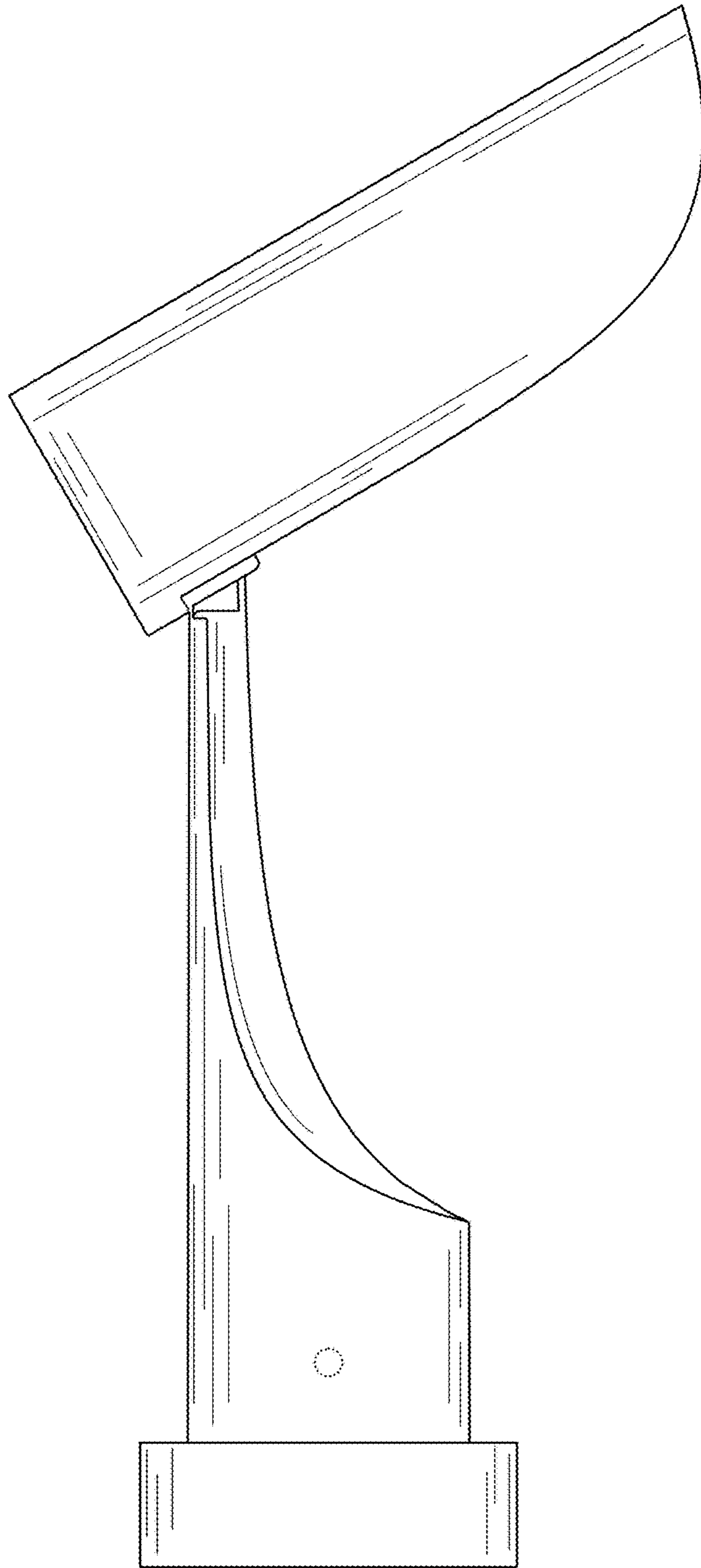

Fig. 11

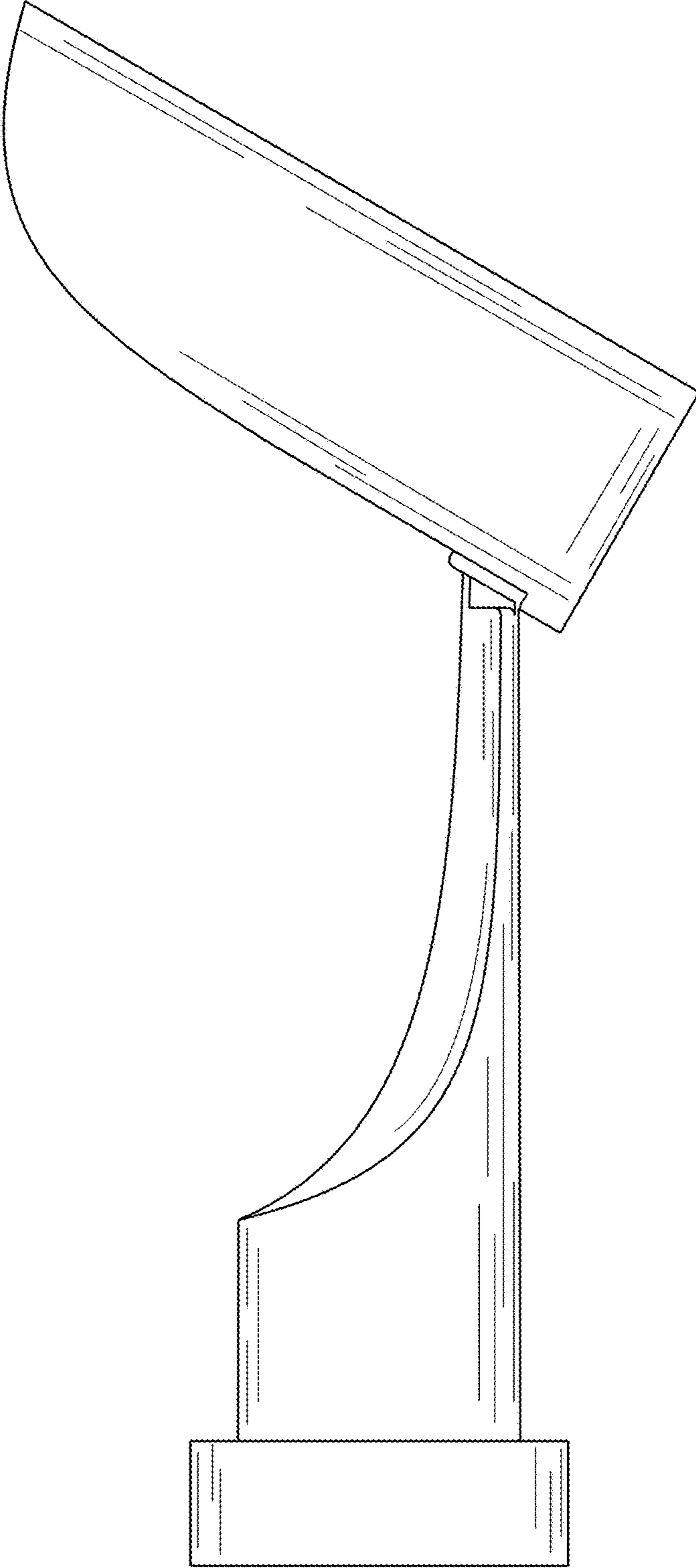

Fig. 12

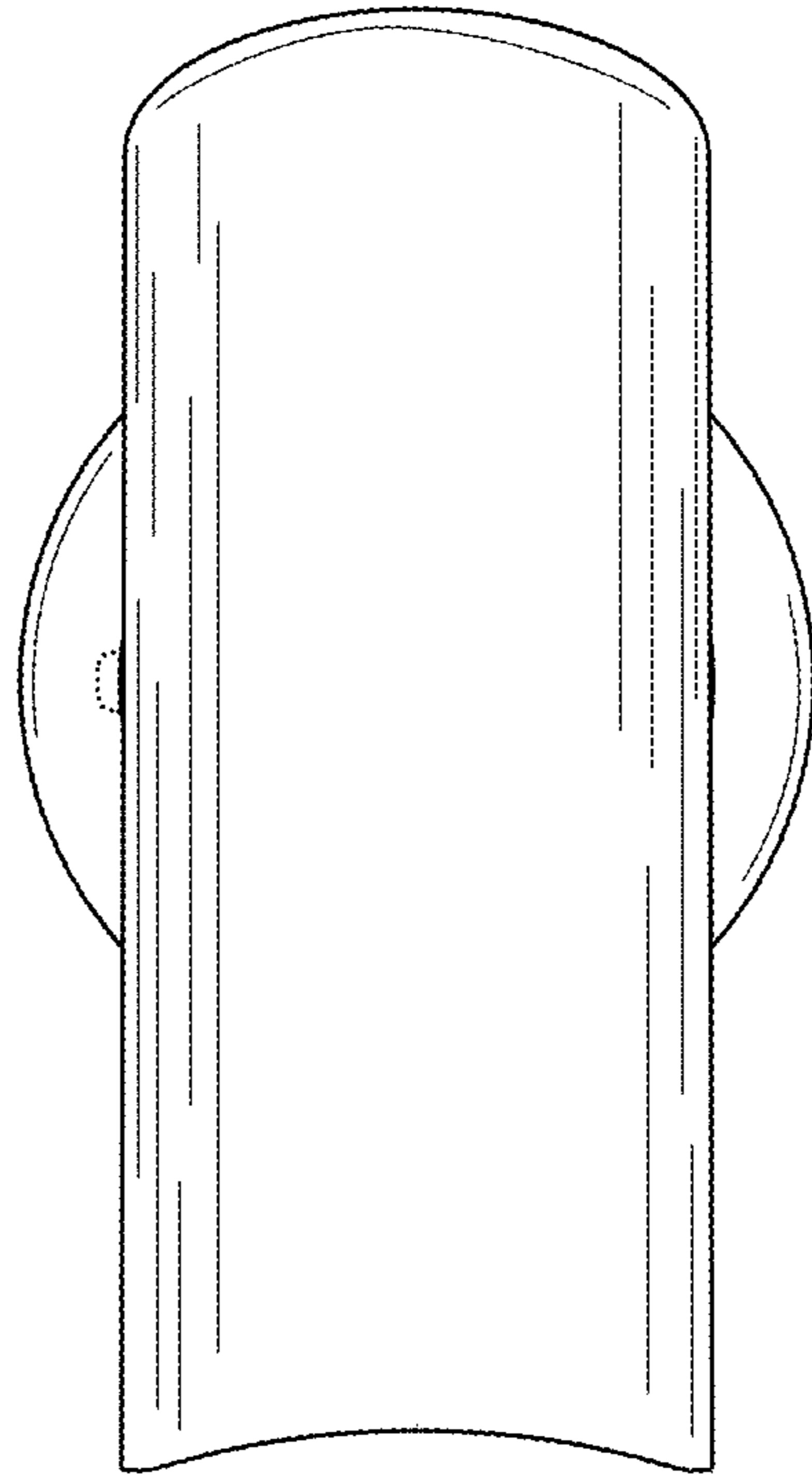

Fig. 13

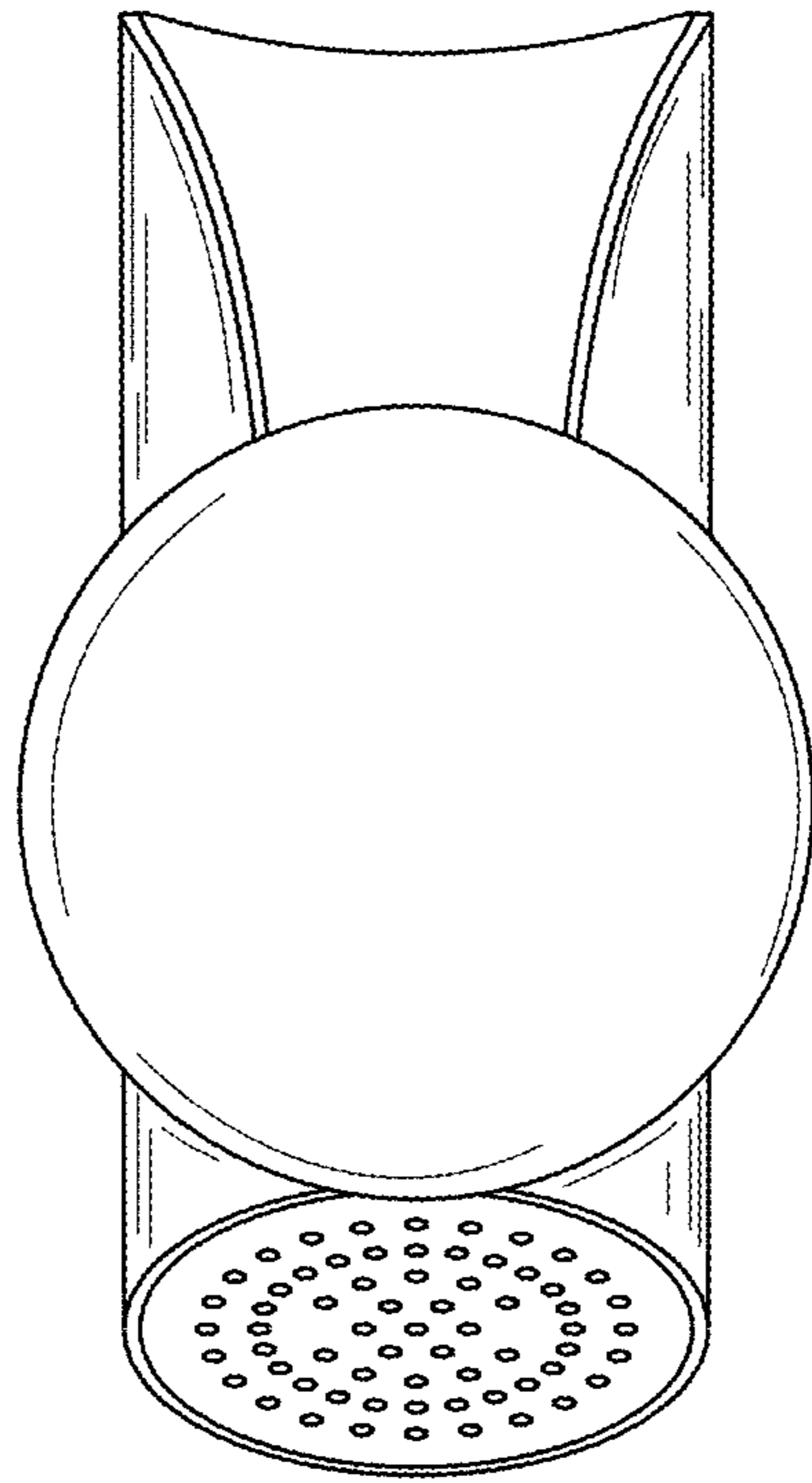

Fig. 14

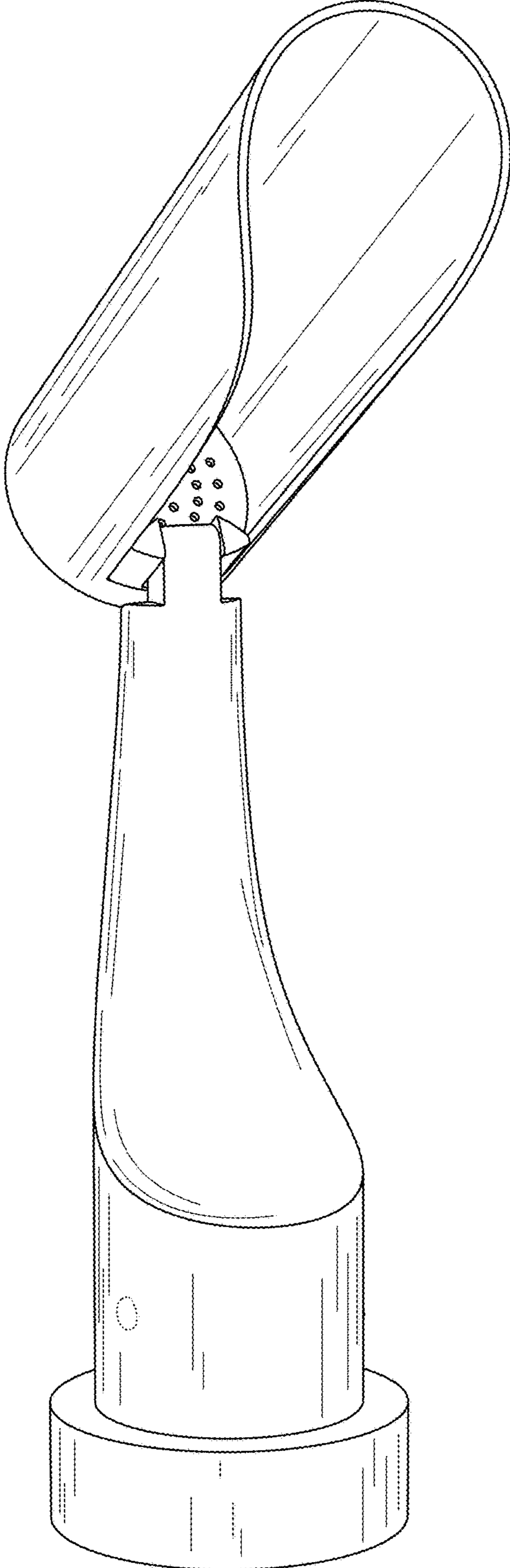

Fig. 15



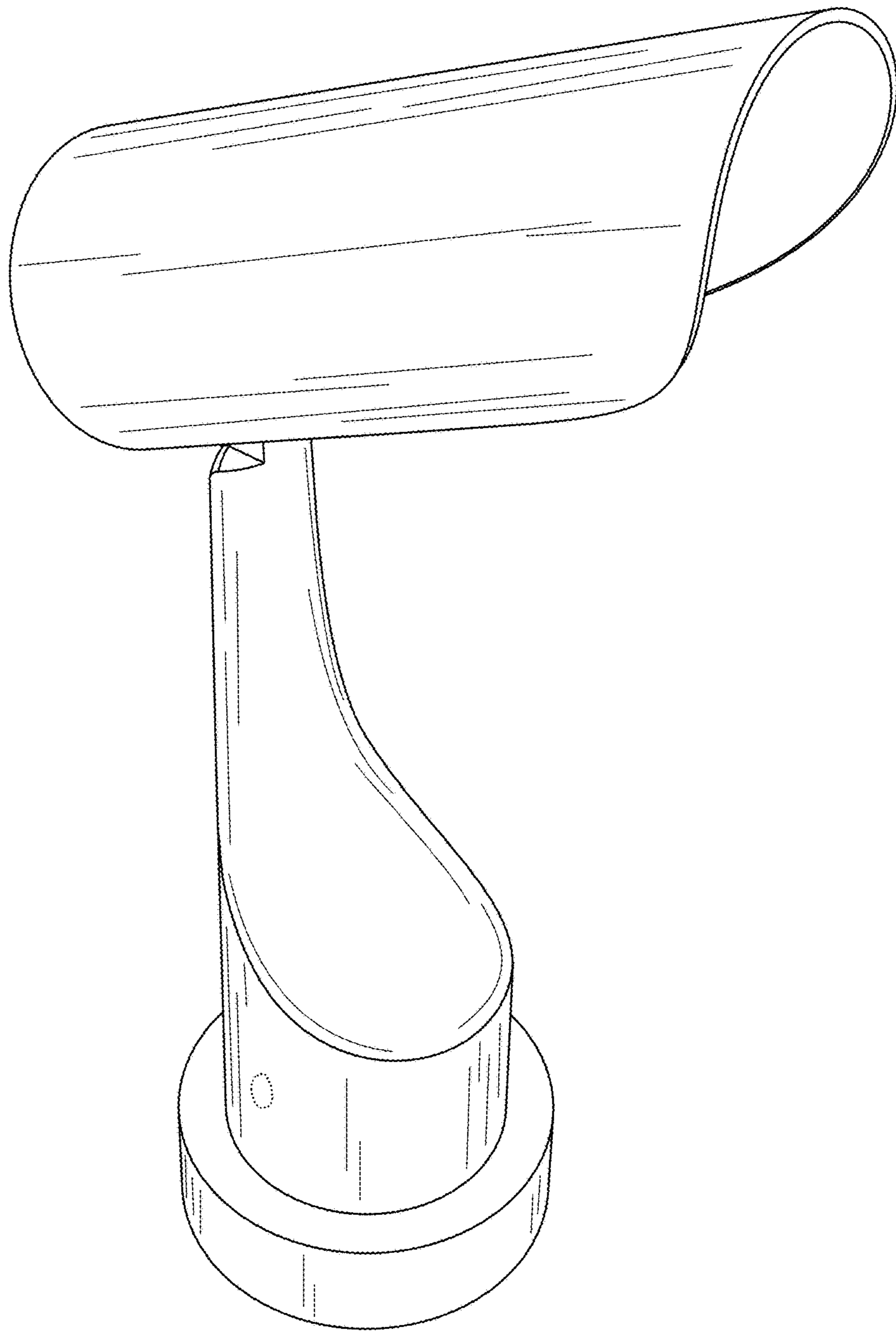

Fig. 16



Fig. 17