



US00D797267S

(12) **United States Design Patent** (10) **Patent No.:** **US D797,267 S**
Park et al. (45) **Date of Patent:** **** Sep. 12, 2017**

(54) **AIR CONDITIONER** D689,994 S * 9/2013 Jun D23/351
D701,596 S 3/2014 Yoo et al.
(71) Applicant: **Samsung Electronics Co., Ltd.**, D708,724 S * 7/2014 Yoo D23/351
Suwon-si, Gyeonggi-do (KR) D713,022 S * 9/2014 Choi D23/351
D717,419 S * 11/2014 Choi D23/351
(72) Inventors: **Jinsook Park**, Uiwang-si (KR); D729,363 S * 5/2015 Choi D23/351
Minkyung Choi, Seoul (KR); **Yeaseul** D729,364 S * 5/2015 Choi D23/351
You, Seoul (KR) D729,916 S * 5/2015 Choi D23/351
D733,857 S * 7/2015 Choi D23/351
(73) Assignee: **SAMSUNG ELECTRONICS CO.,** D777,308 S * 1/2017 Bu D23/354
LTD., Gyeonggi-Do (KR) D778,418 S * 2/2017 Bu D23/354

FOREIGN PATENT DOCUMENTS

(**) Term: **15 Years**
(21) Appl. No.: **29/542,594**
(22) Filed: **Oct. 15, 2015**
(30) **Foreign Application Priority Data**
Jul. 21, 2015 (KR) 30-2015-0036800

KR 300729251 S 2/2014
KR 300709266 S 12/2014

* cited by examiner

Primary Examiner — George D. Kirschbaum
Assistant Examiner — Natasha Vujcic
(74) *Attorney, Agent, or Firm* — Cantor Colburn LLP

(51) **LOC (10) Cl.** **23-04**
(52) **U.S. Cl.**
USPC **D23/351**
(58) **Field of Classification Search**
USPC D23/333, 335, 341, 342, 351, 353, 354,
D23/355, 356, 359, 364, 365, 370, 385,
D23/386, 388, 393
CPC F24F 1/00; F24F 1/0007; F24F 1/02; F24F
1/08; F24F 1/42; F24F 1/56; F24F 1/60;
F24F 3/044; F24F 3/048; F24F 3/16;
F24F 7/00; F24F 7/04; F24F 12/001;
F24F 12/006
See application file for complete search history.

(57) **CLAIM**

The ornamental design for an air conditioner, as shown and described.

DESCRIPTION

FIG. 1 is a perspective view of an air conditioner, showing our new design;
FIG. 2 is a front view thereof;
FIG. 3 is a rear view thereof;
FIG. 4 is a left side view thereof;
FIG. 5 is a right side view thereof;
FIG. 6 is a top view thereof;
FIG. 7 is a bottom view thereof; and,
FIG. 8 is a partially enlarged view of FIG. 6.
The broken lines illustrating portions of an air conditioner form no part of the claimed design.

(56) **References Cited**
U.S. PATENT DOCUMENTS

5,184,879 A * 2/1993 Brossardt H02B 1/30
312/236
D689,993 S * 9/2013 Yoon D23/351

1 Claim, 8 Drawing Sheets

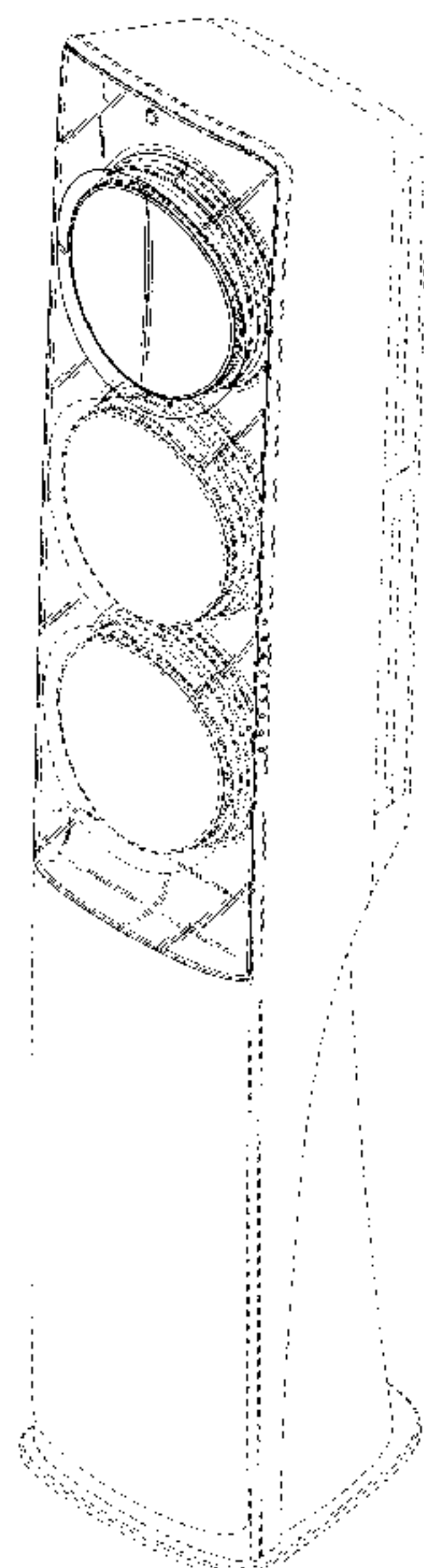

FIG. 1

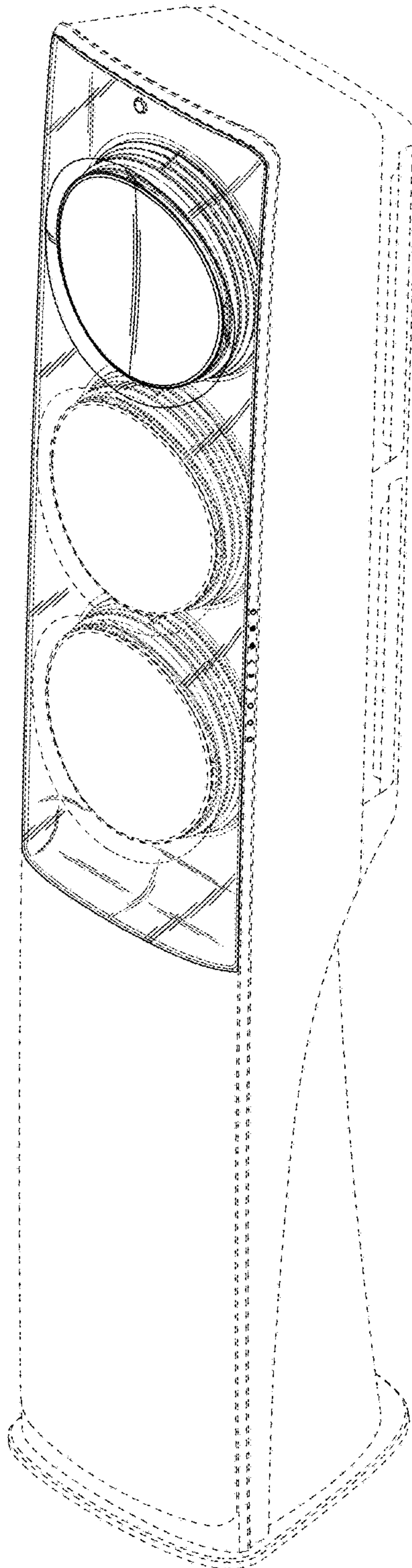

FIG. 2

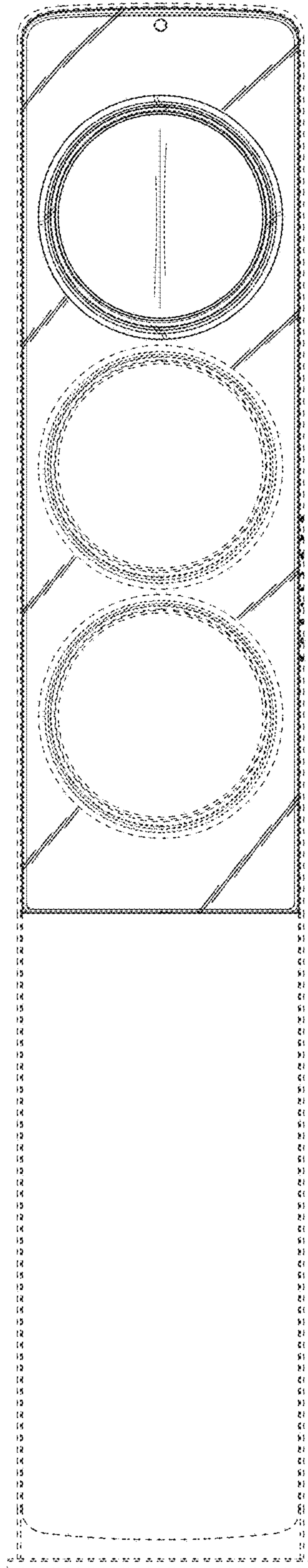

FIG. 3

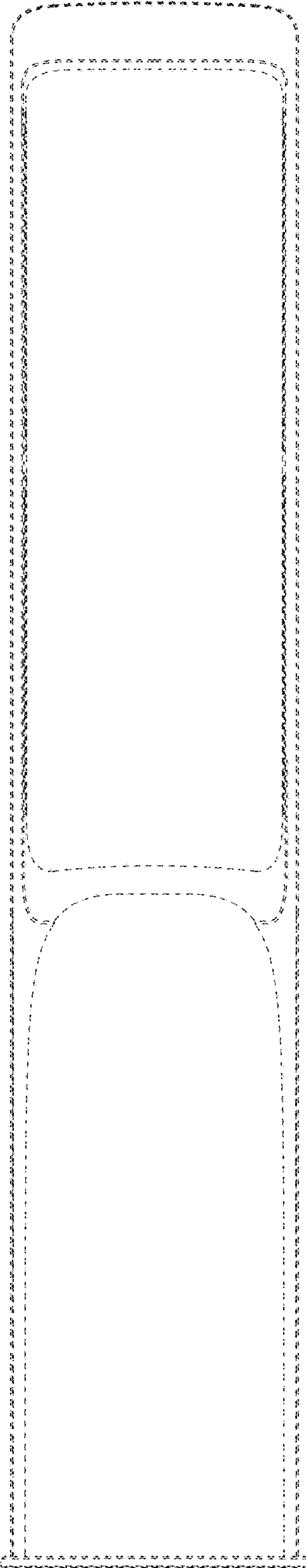

FIG. 4

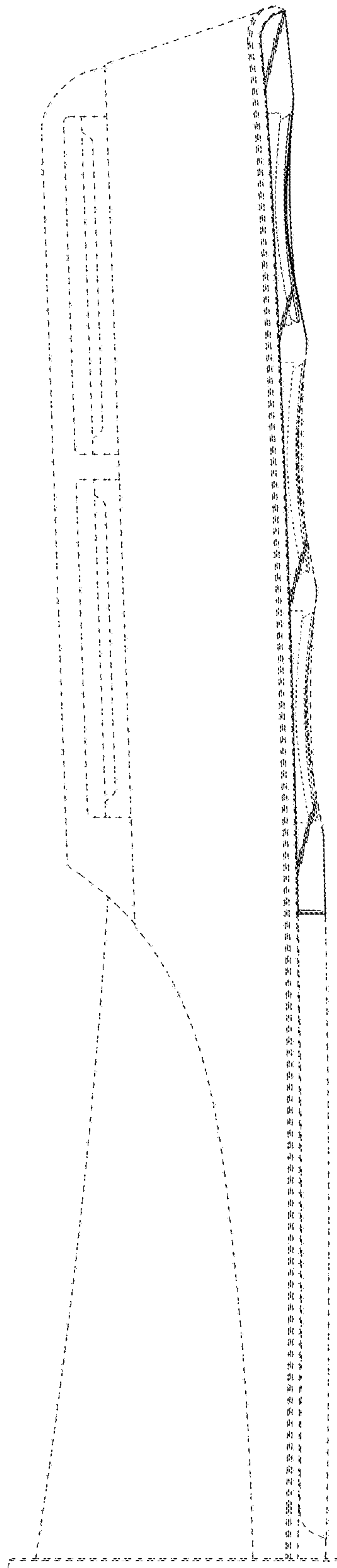

FIG. 5

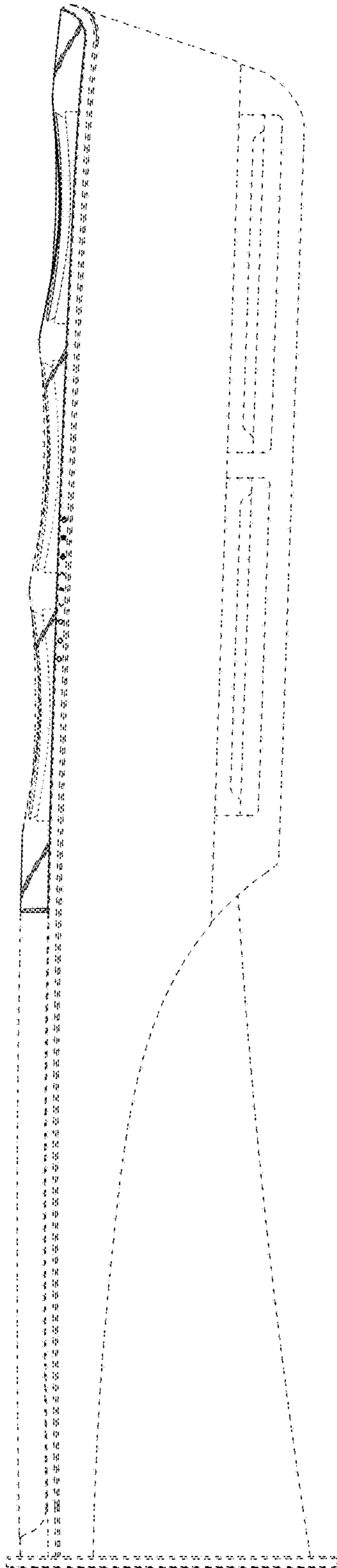

FIG. 6

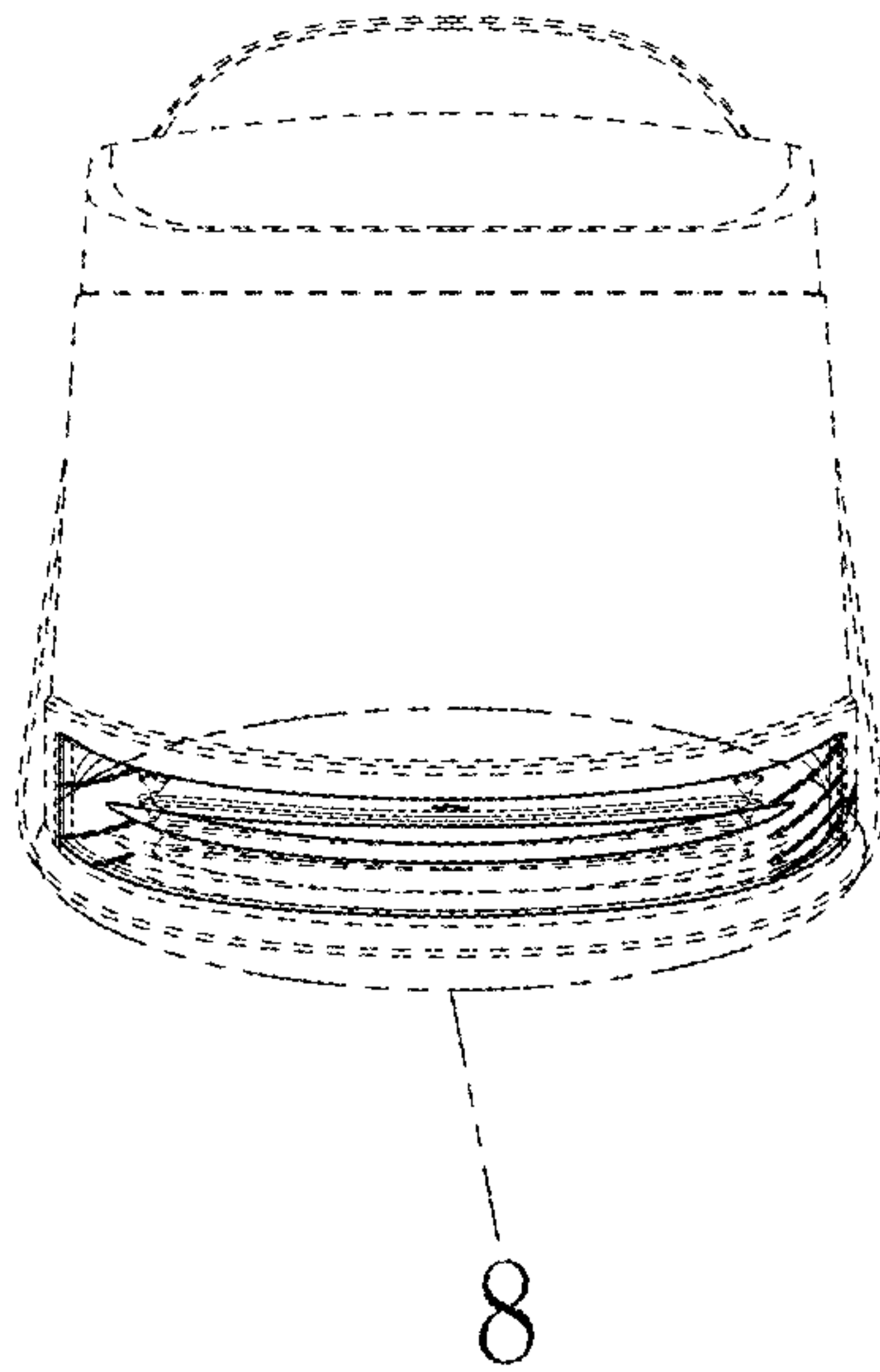

FIG. 7

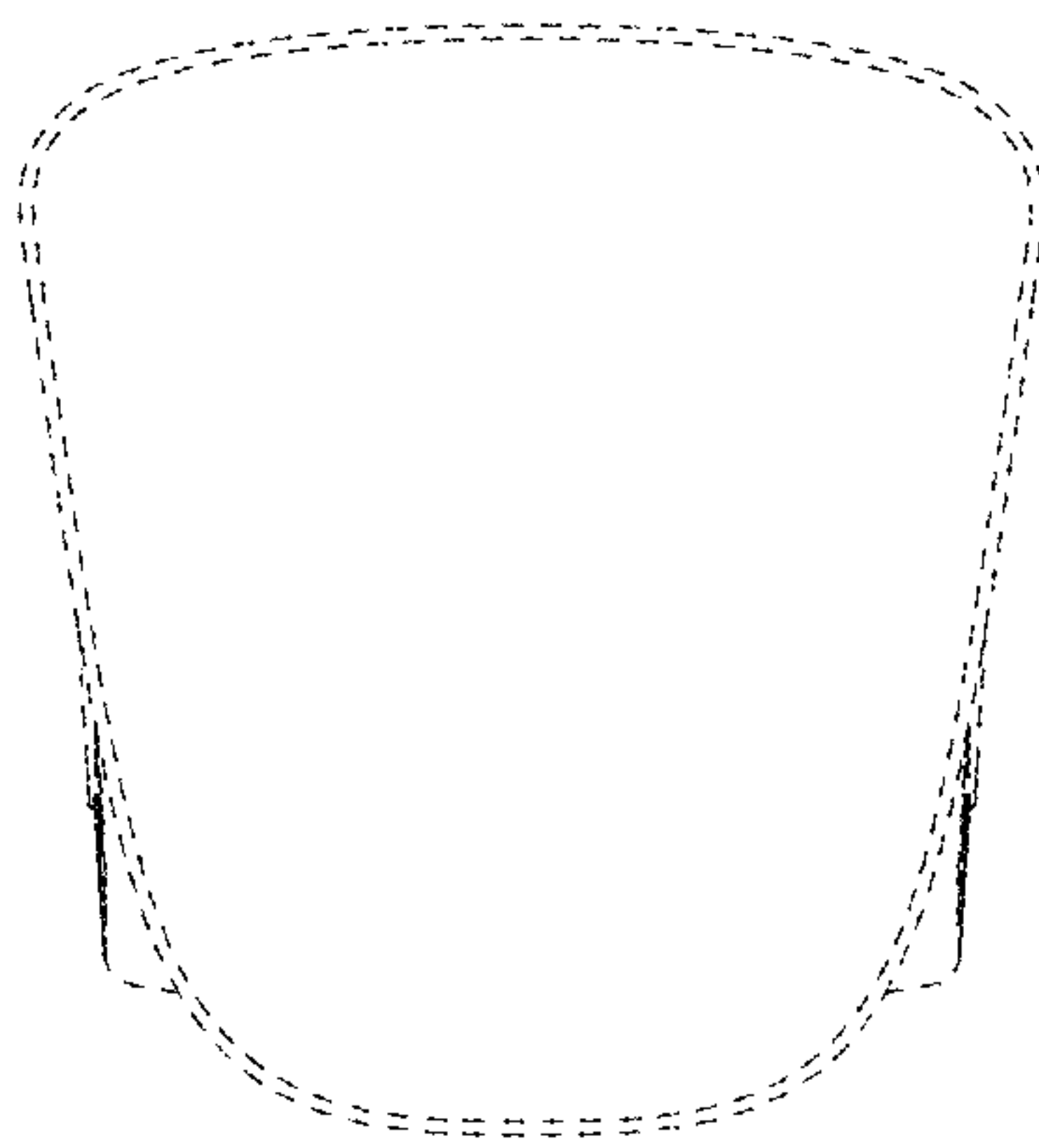

FIG. 8

