



US00D797255S

(12) **United States Design Patent** (10) **Patent No.:** **US D797,255 S**
Potter et al. (45) **Date of Patent:** **** Sep. 12, 2017**

(54) **FAUCET HANDLE**

FOREIGN PATENT DOCUMENTS

(71) Applicant: **Spectrum Brands, Inc.**, Middleton, WI (US)
(72) Inventors: **Cameron Potter**, Fullerton, CA (US); **David Downey**, Mission Viejo, CA (US)
(73) Assignee: **Spectrum Brands, Inc.**, Middleton, WI (US)

CN	301376107	11/2010
CN	301376108	11/2010
CN	302932250	9/2014
CN	303591734	2/2016
CN	303597486	2/2016
EM	302260737-0002	6/2013
EM	302260737-0008	6/2013
EM	302421370-0005	4/2014
WO	D067782-009	10/2006
WO	D067782-010	10/2006
WO	D073793-001	6/2010
WO	D073793-002	6/2010

(**) Term: **15 Years**

* cited by examiner

(21) Appl. No.: **29/561,347**

Primary Examiner — Robert Delehanty

(22) Filed: **Apr. 15, 2016**

(74) *Attorney, Agent, or Firm* — Banner & Witcoff, Ltd.

(51) **LOC (10) Cl.** **23-01**

(57) **CLAIM**

(52) **U.S. Cl.**

The ornamental design for a faucet handle, as shown and described.

USPC **D23/252**

DESCRIPTION

(58) **Field of Classification Search**

USPC D23/238–243, 249, 255, 257, 250, 252, D23/254; D8/307–308

CPC E03C 1/0404; E03C 1/0409; E03C 1/02; E03C 1/023; E03C 1/05; E03C 1/0412; G05D 7/0629; Y10T 137/9464

See application file for complete search history.

FIG. 1 is a front perspective view of a faucet handle showing our new design;

FIG. 2 is a front view thereof;

FIG. 3 is a rear view thereof;

FIG. 4 is a right side view thereof;

FIG. 5 is a left side view thereof;

FIG. 6 is a top view thereof;

FIG. 7 is a bottom view thereof; and,

FIG. 8 is an enlarged cross sectional view taken through line 8-8 of FIG. 2.

The broken line showing of the remainder of the faucet is for environmental purposes only and forms no part of the claimed design.

(56) **References Cited**

U.S. PATENT DOCUMENTS

D531,483 S	*	11/2006	Kosasih	D8/308
D650,048 S	*	12/2011	Jones	D23/252
D686,705 S		7/2013	Fritz		
D754,823 S	*	4/2016	Garland	D23/252

1 Claim, 6 Drawing Sheets

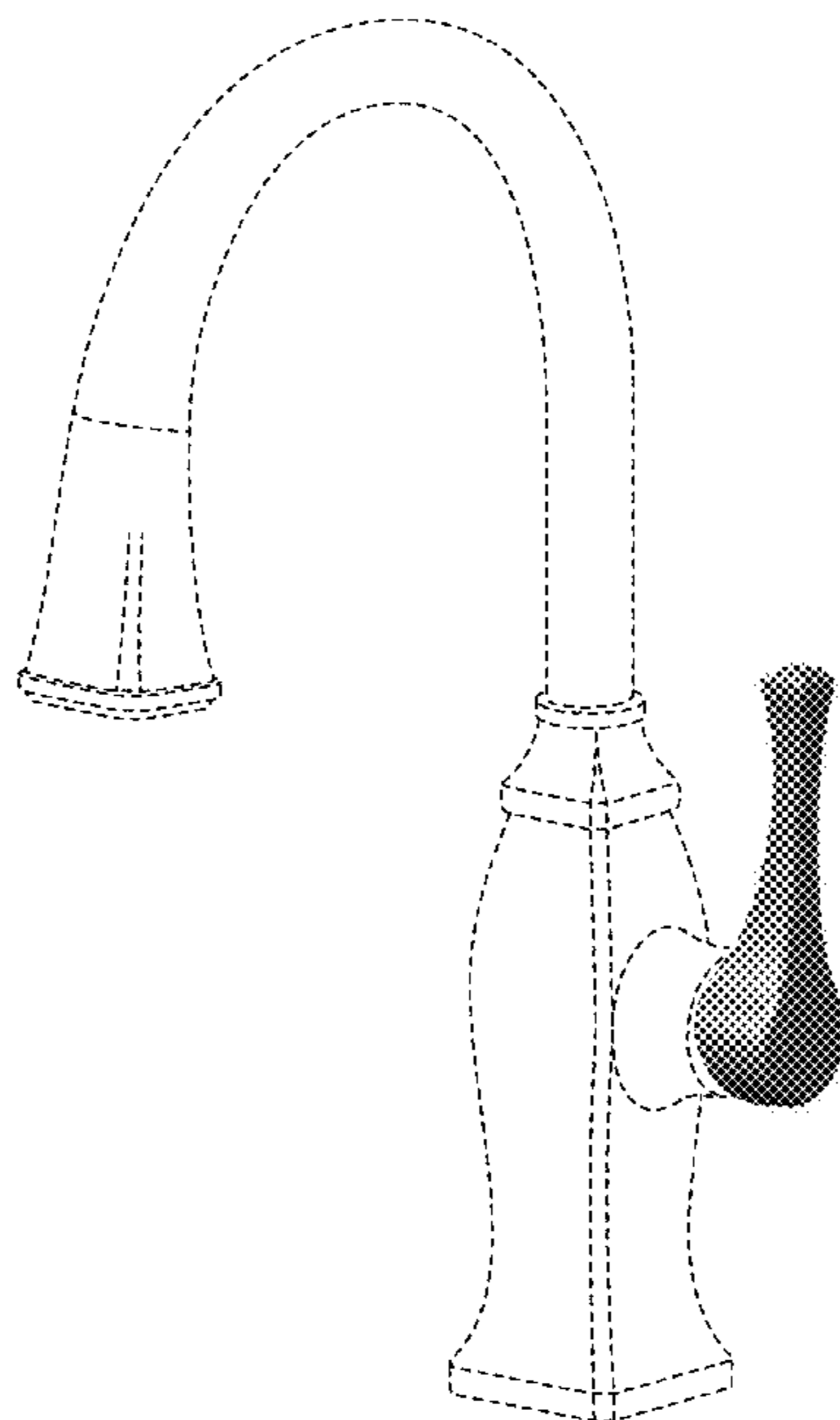

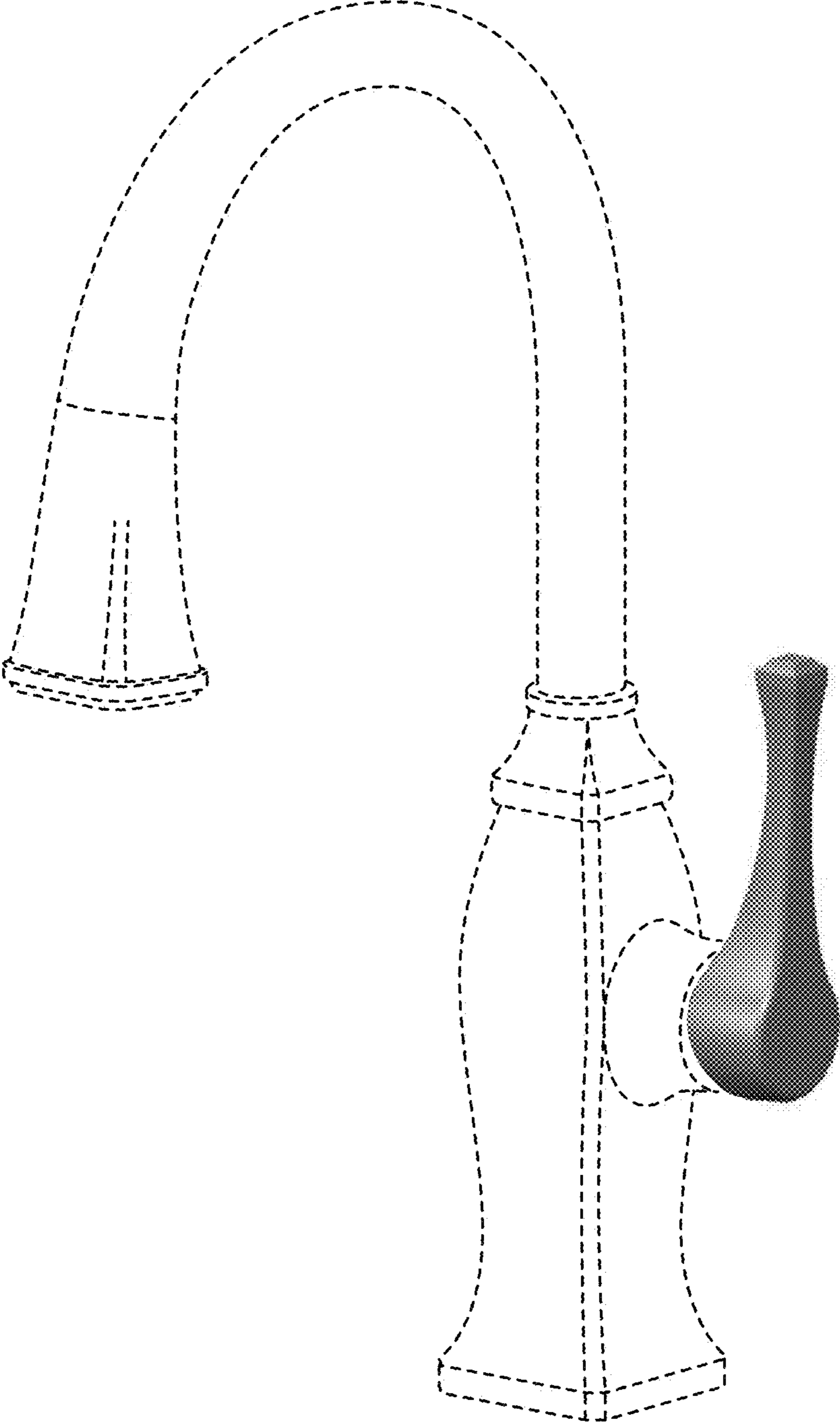

FIG. 1

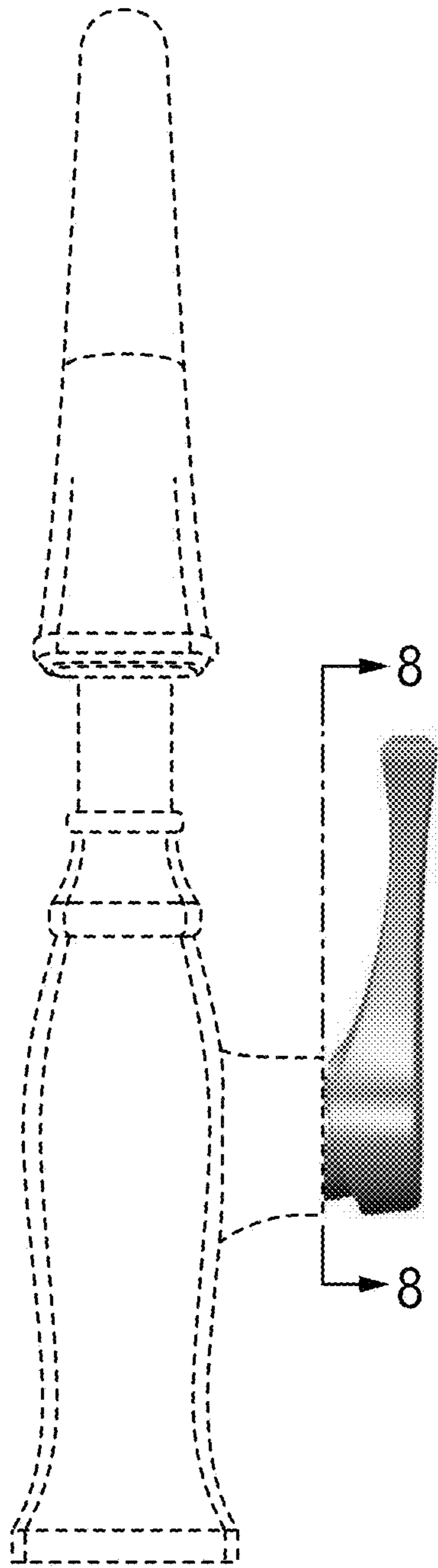

FIG. 2

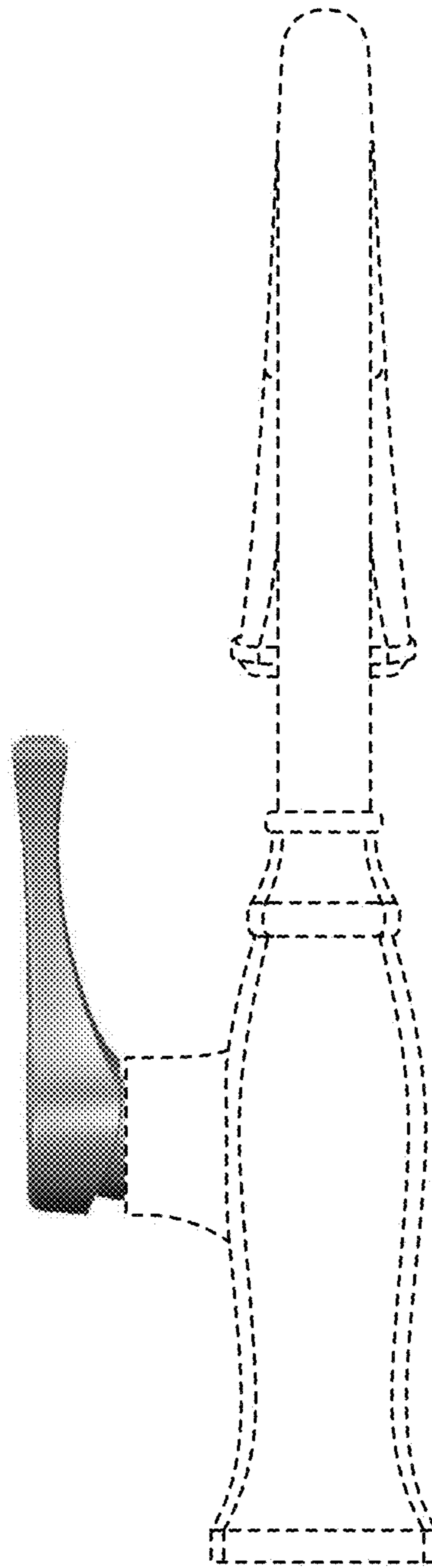

FIG. 3

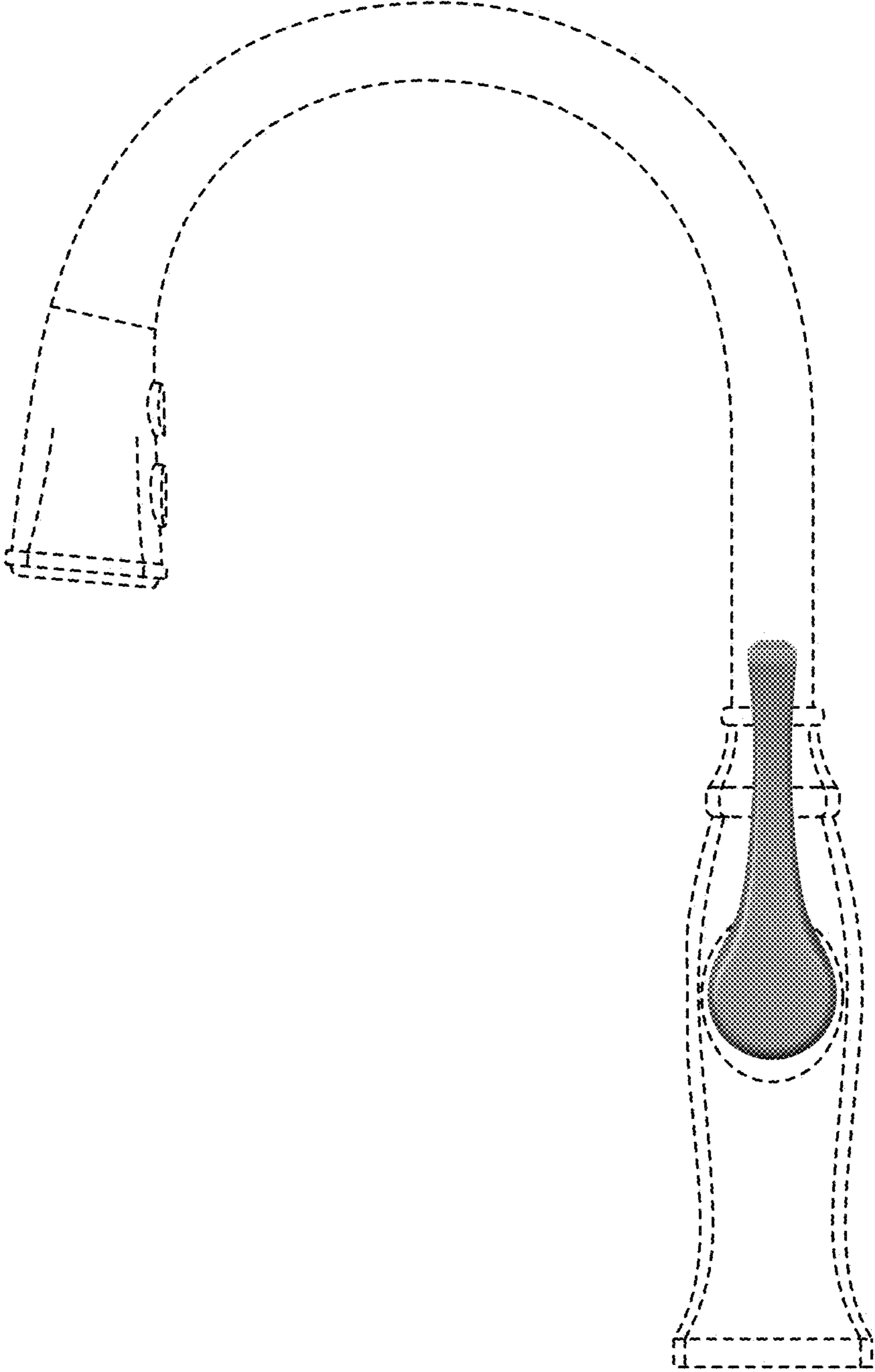

FIG. 4

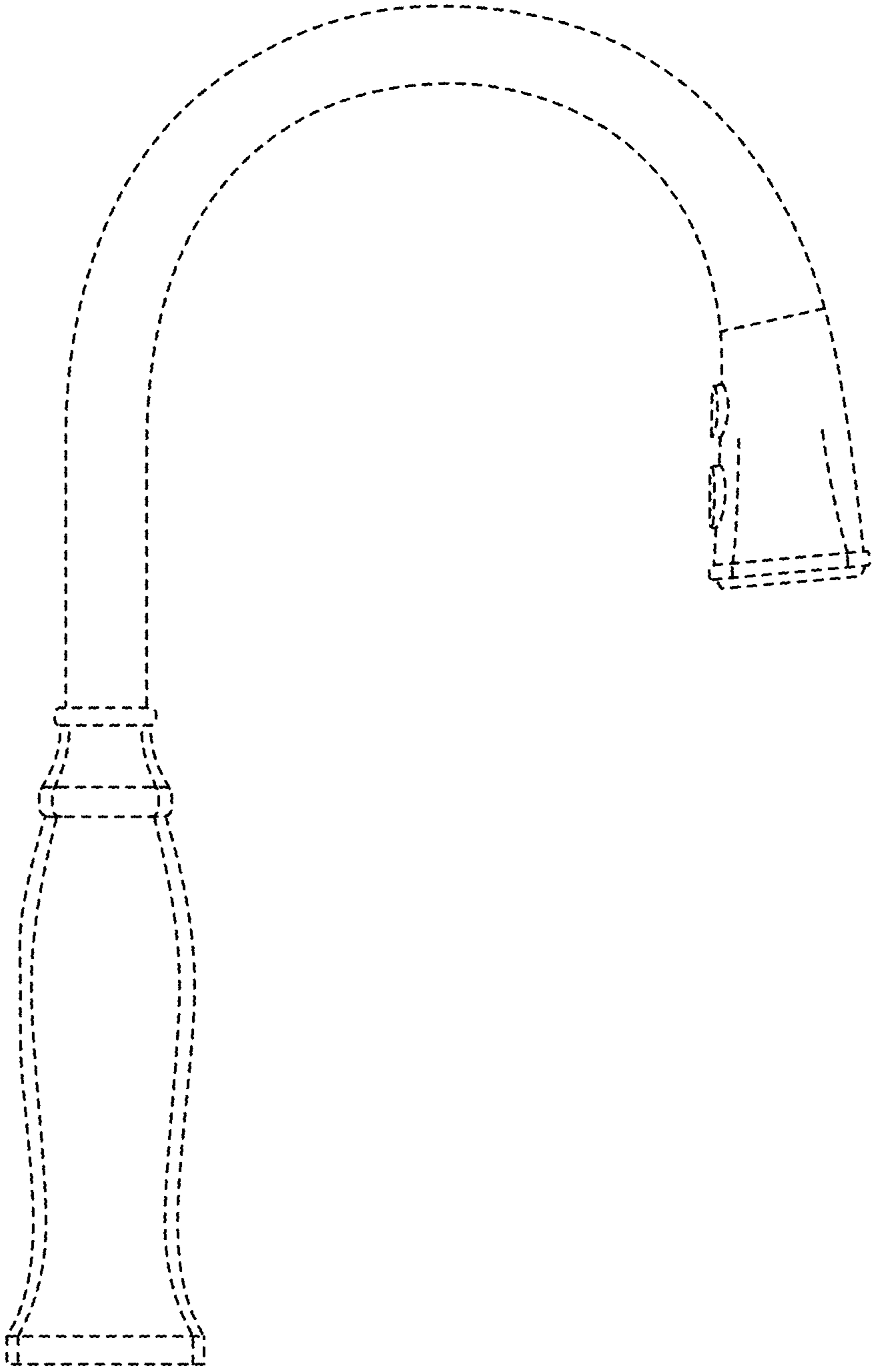

FIG. 5

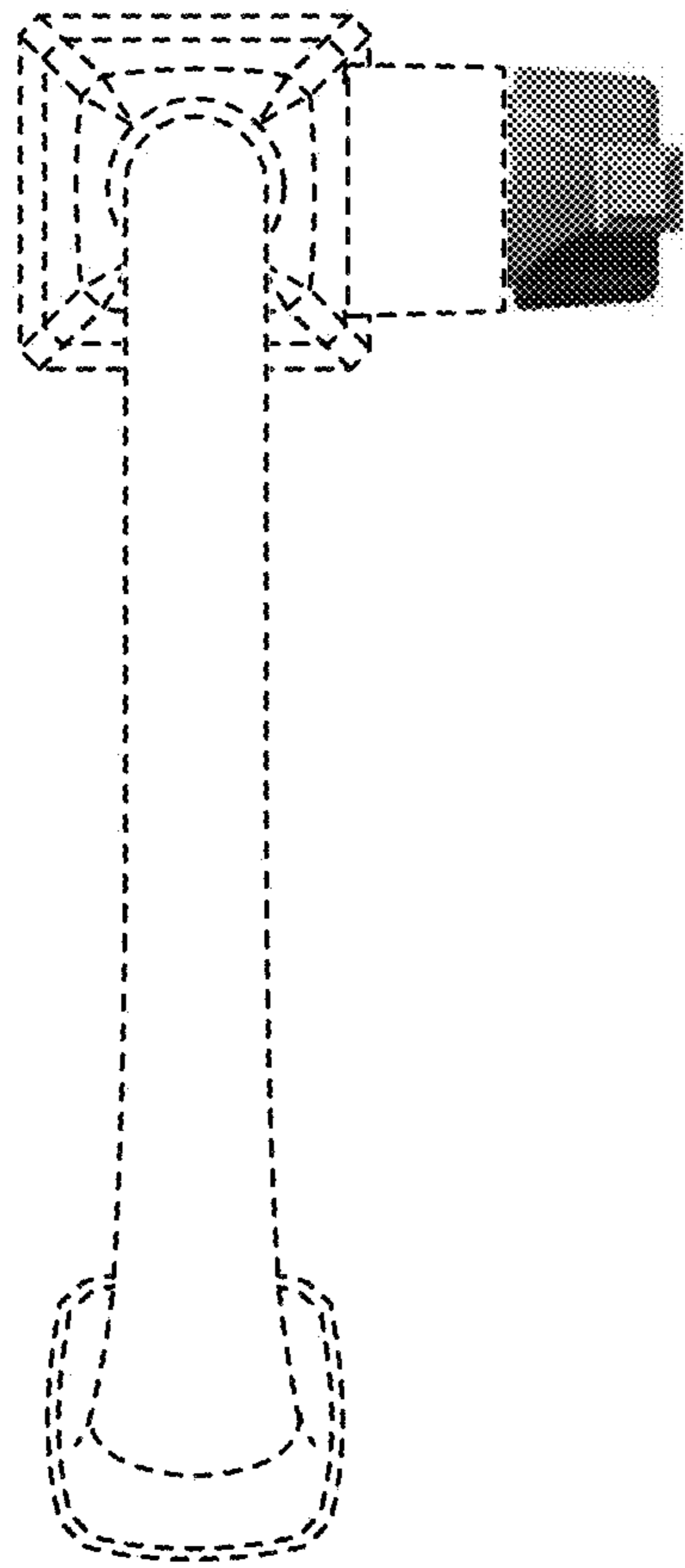

FIG. 6

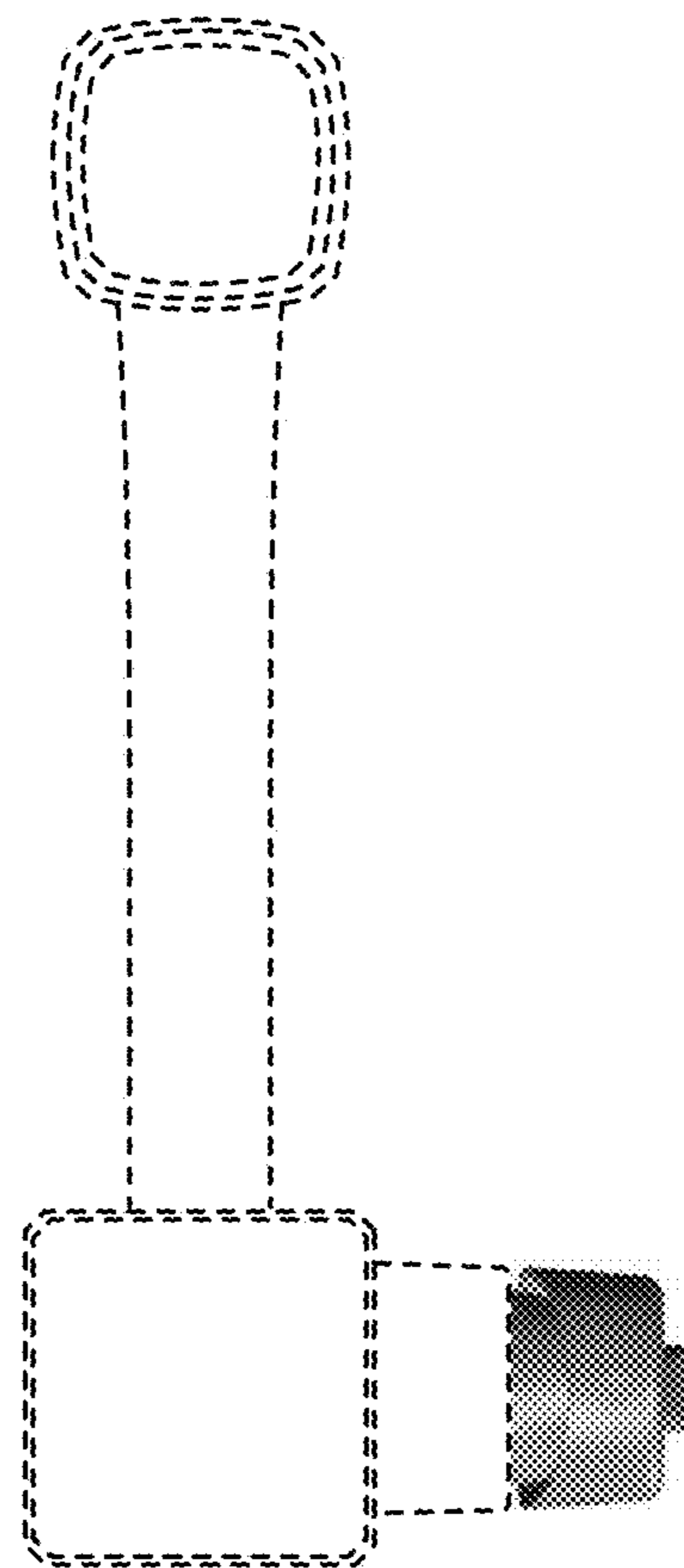

FIG. 7

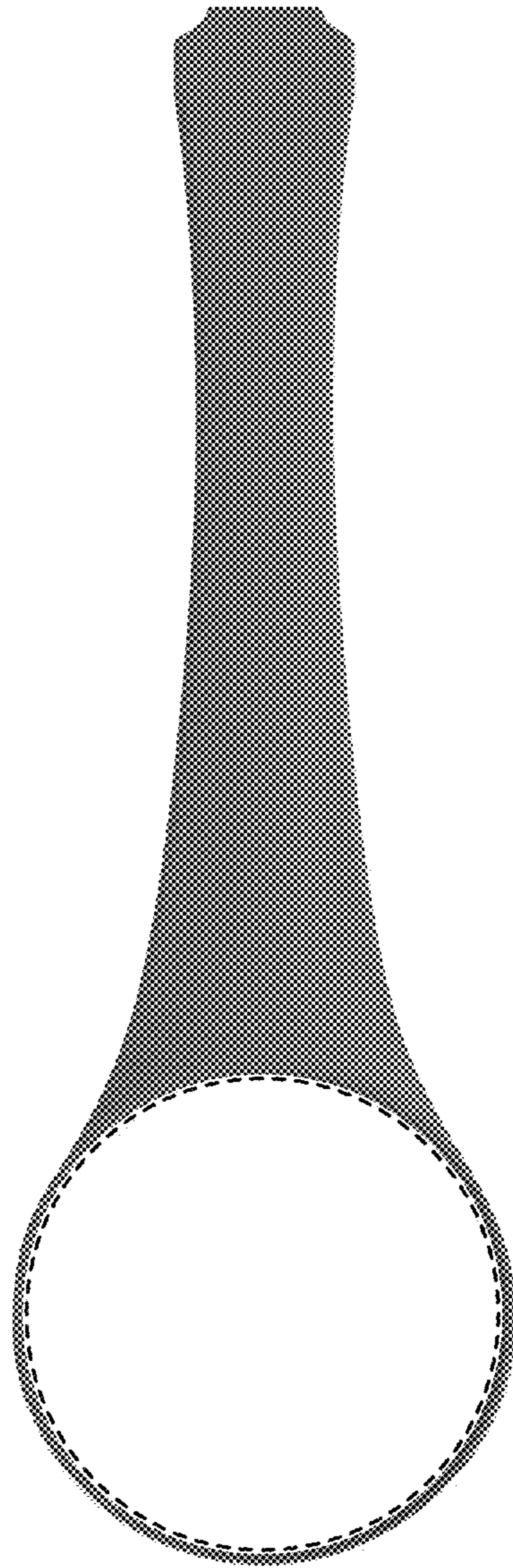

FIG. 8