



US00D797223S

(12) **United States Design Patent**
Kitching, Jr. et al.

(10) **Patent No.:** **US D797,223 S**

(45) **Date of Patent:** **** Sep. 12, 2017**

(54) **IRON GOLF CLUB HEAD**

(71) Applicant: **Acushnet Company**, Fairhaven, MA
(US)

(72) Inventors: **Joseph F. Kitching, Jr.**, Carlsbad, CA
(US); **Jason A. Mata**, Carlsbad, CA
(US)

(73) Assignee: **Acushnet Company**, Fairhaven, MA
(US)

(**) Term: **15 Years**

(21) Appl. No.: **29/564,406**

(22) Filed: **May 12, 2016**

(51) **LOC (10) Cl.** **21-02**

(52) **U.S. Cl.**
USPC **D21/747**

(58) **Field of Classification Search**
USPC D21/747-751, 759
CPC A63B 53/00; A63B 53/04; A63B 53/047;
A63B 53/0475; A63B 53/0445; A63B
2053/0479
See application file for complete search history.

(56) **References Cited**

U.S. PATENT DOCUMENTS

D244,703 S * 6/1977 Guzzle 473/345
D323,689 S * 2/1992 Hardman D21/748

D323,690 S * 2/1992 Hlinka D21/748
D397,388 S * 8/1998 Nelson D21/747
D596,684 S * 7/2009 Sutovsky D21/747
D597,157 S * 7/2009 Wallin D21/747
D702,786 S * 4/2014 Engel D21/759
D753,250 S * 4/2016 Song D21/749

* cited by examiner

Primary Examiner — Mitchell Siegel

(74) *Attorney, Agent, or Firm* — Randy K. Chang

(57) **CLAIM**

The ornamental design for an iron golf club head, as shown and described.

DESCRIPTION

FIG. 1 is a top back perspective view of our new iron golf club head;
FIG. 2 is a back view thereof;
FIG. 3 is a bottom view thereof;
FIG. 4 is a top view thereof;
FIG. 5 is a front view thereof;
FIG. 6 is a heel side view thereof; and,
FIG. 7 is a toe side view thereof.

1 Claim, 2 Drawing Sheets

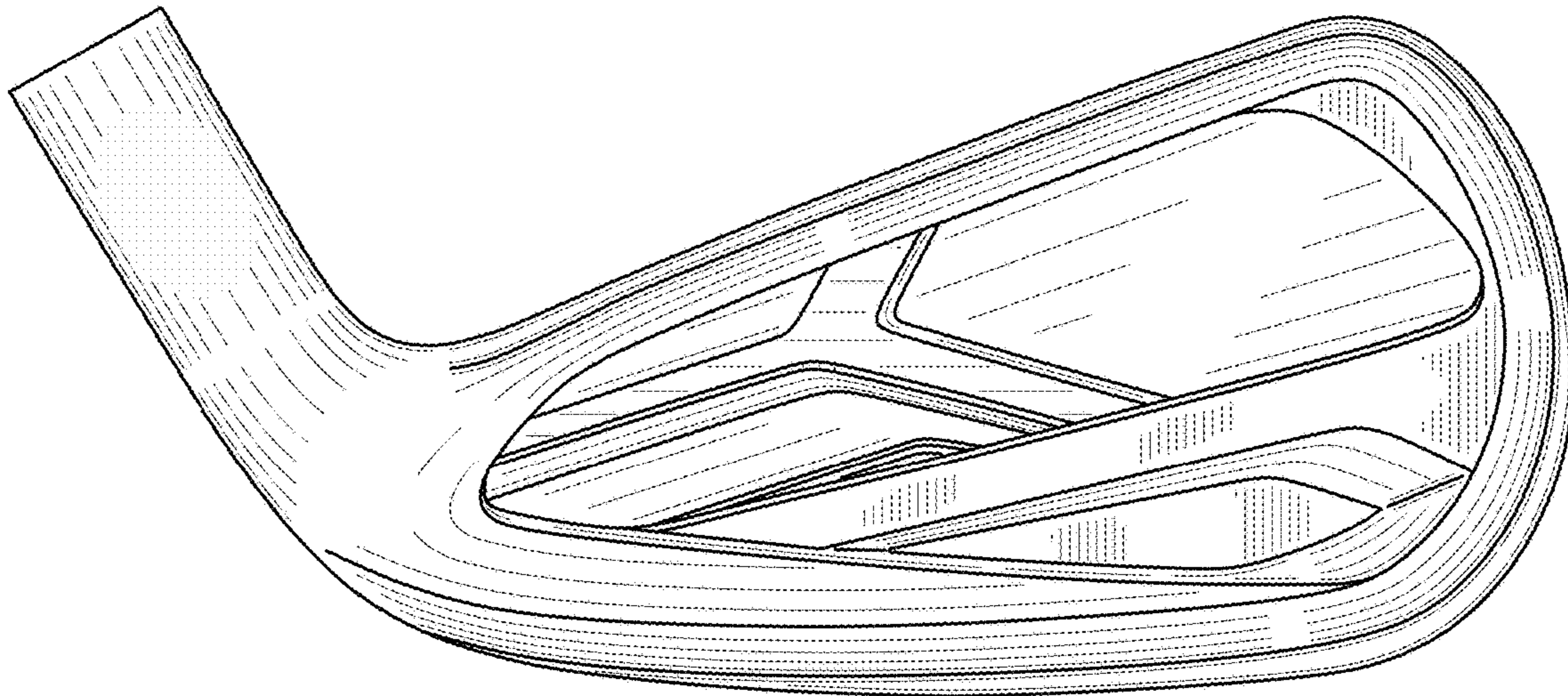

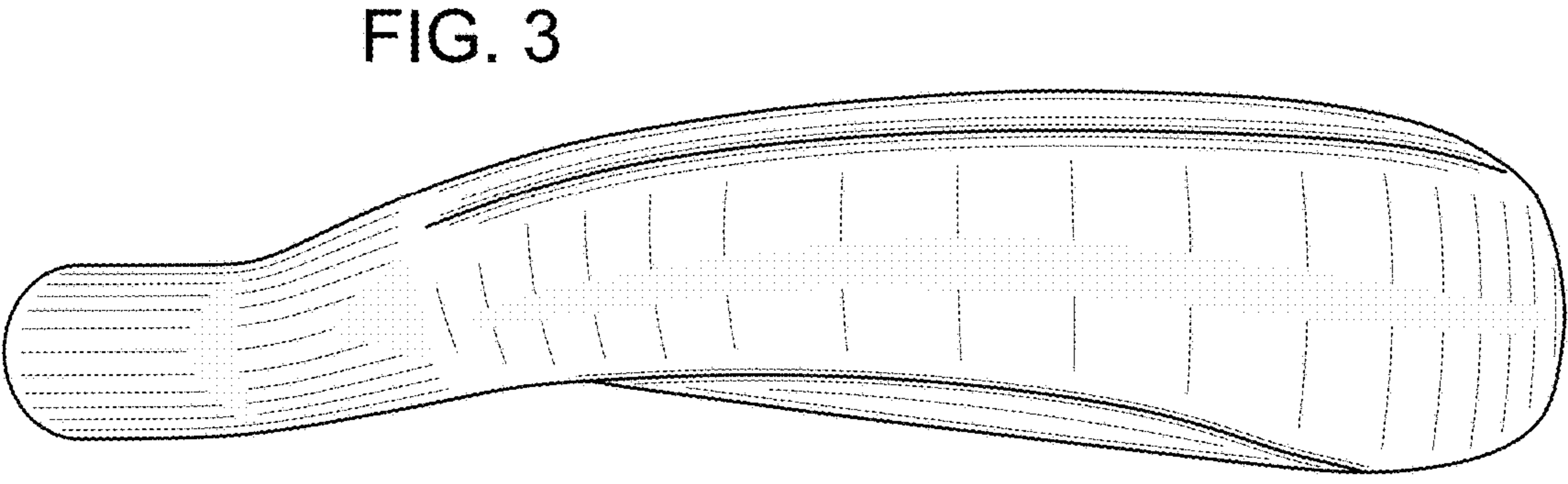
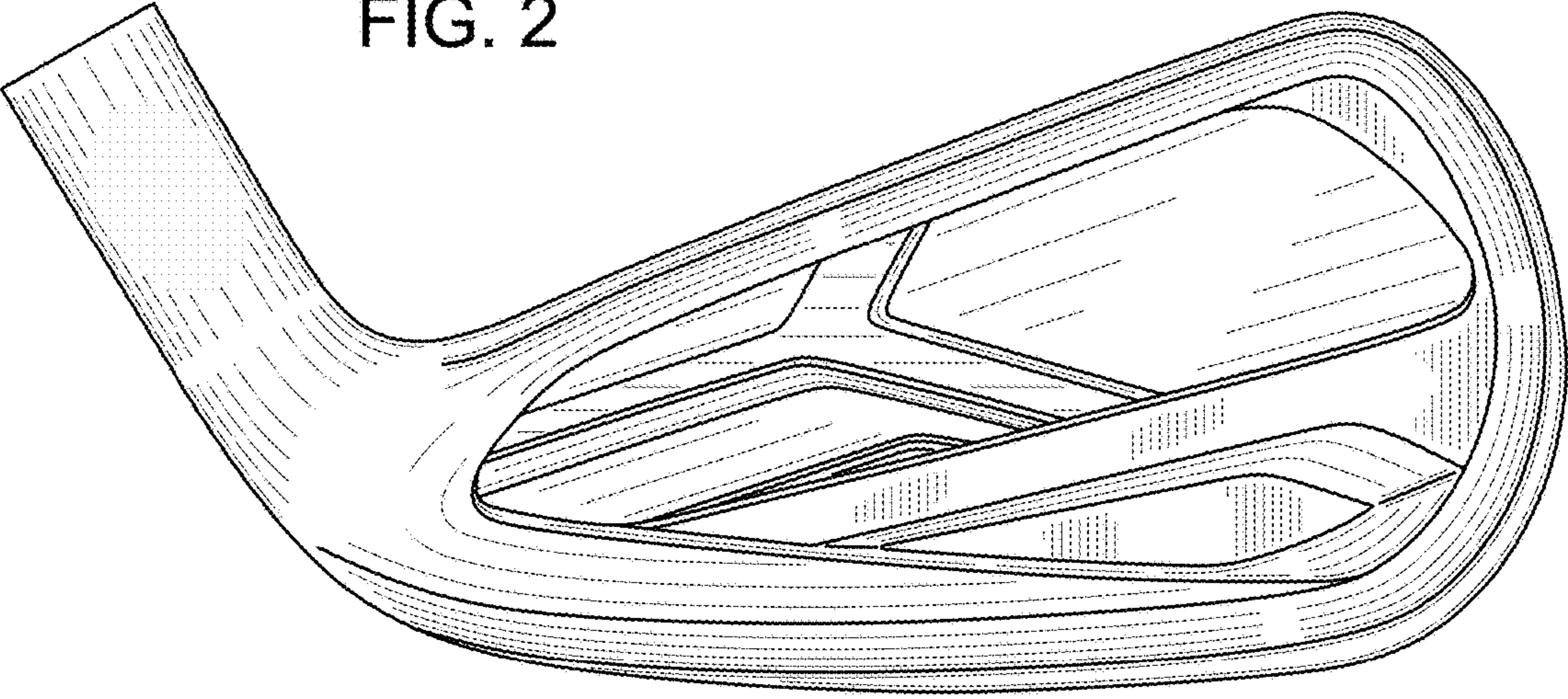
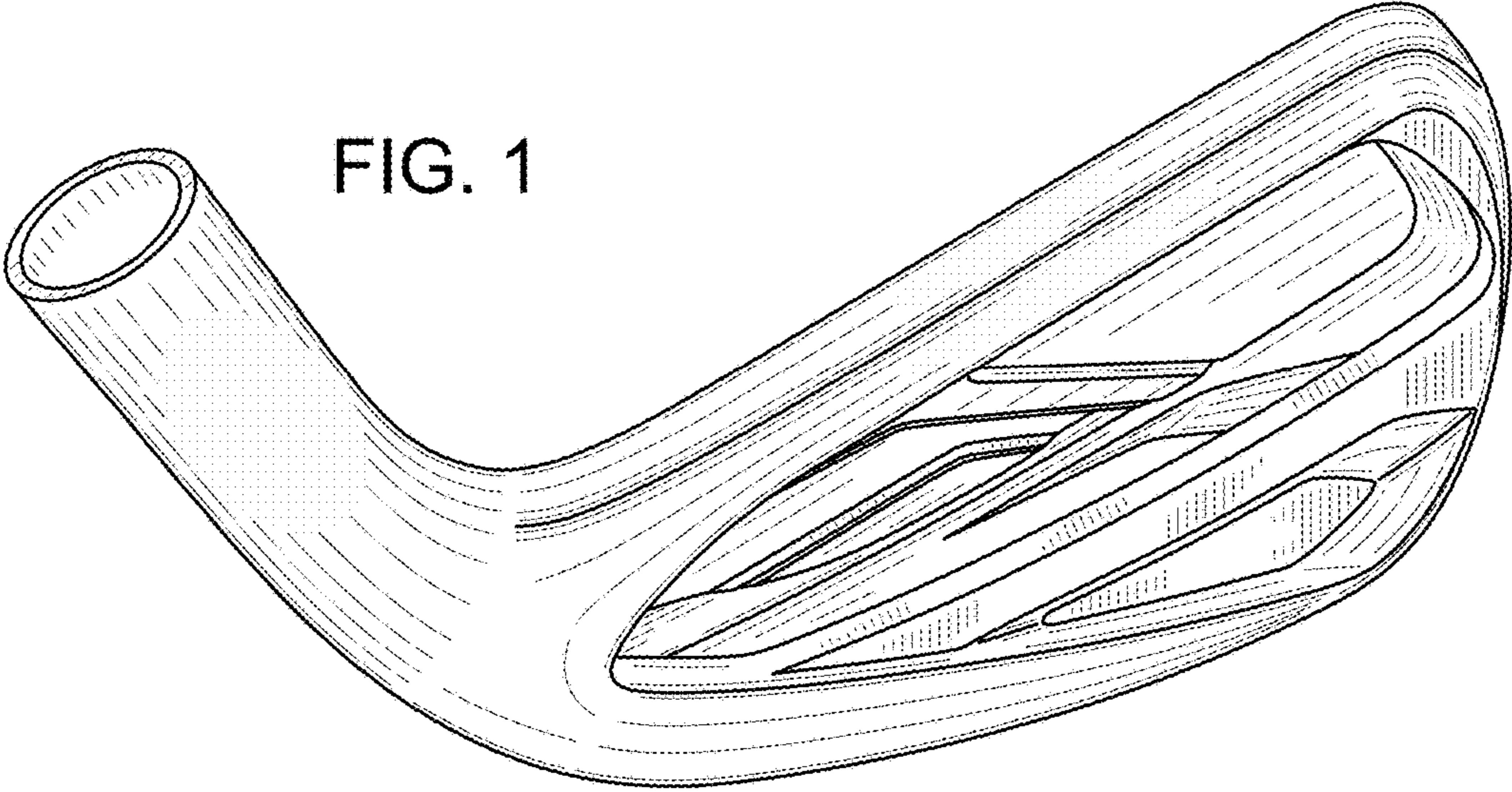

FIG. 4

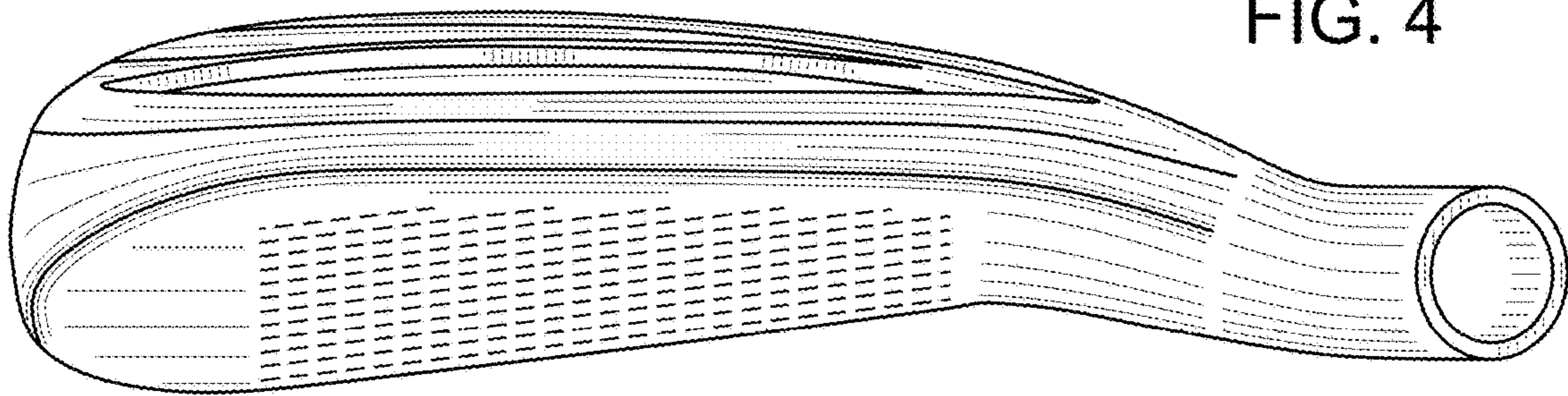

FIG. 5

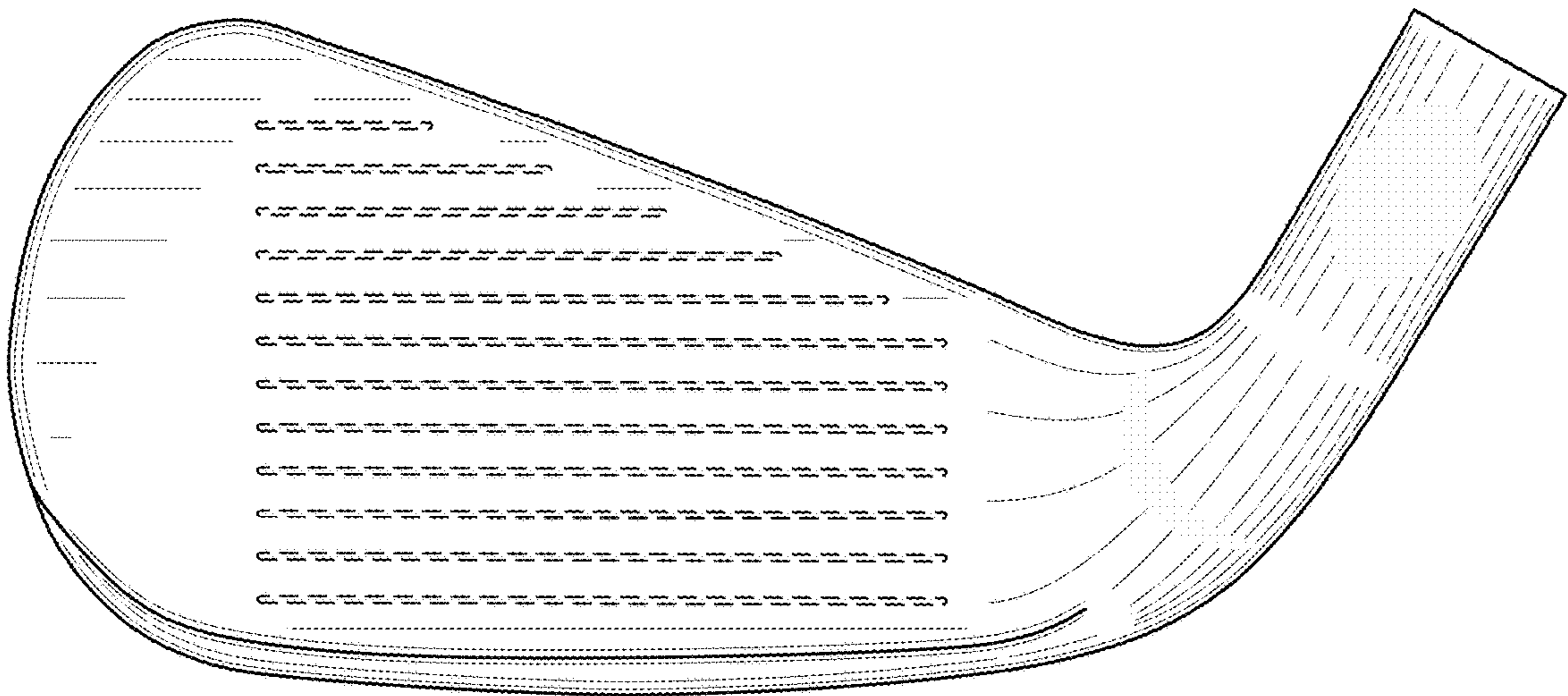

FIG. 6

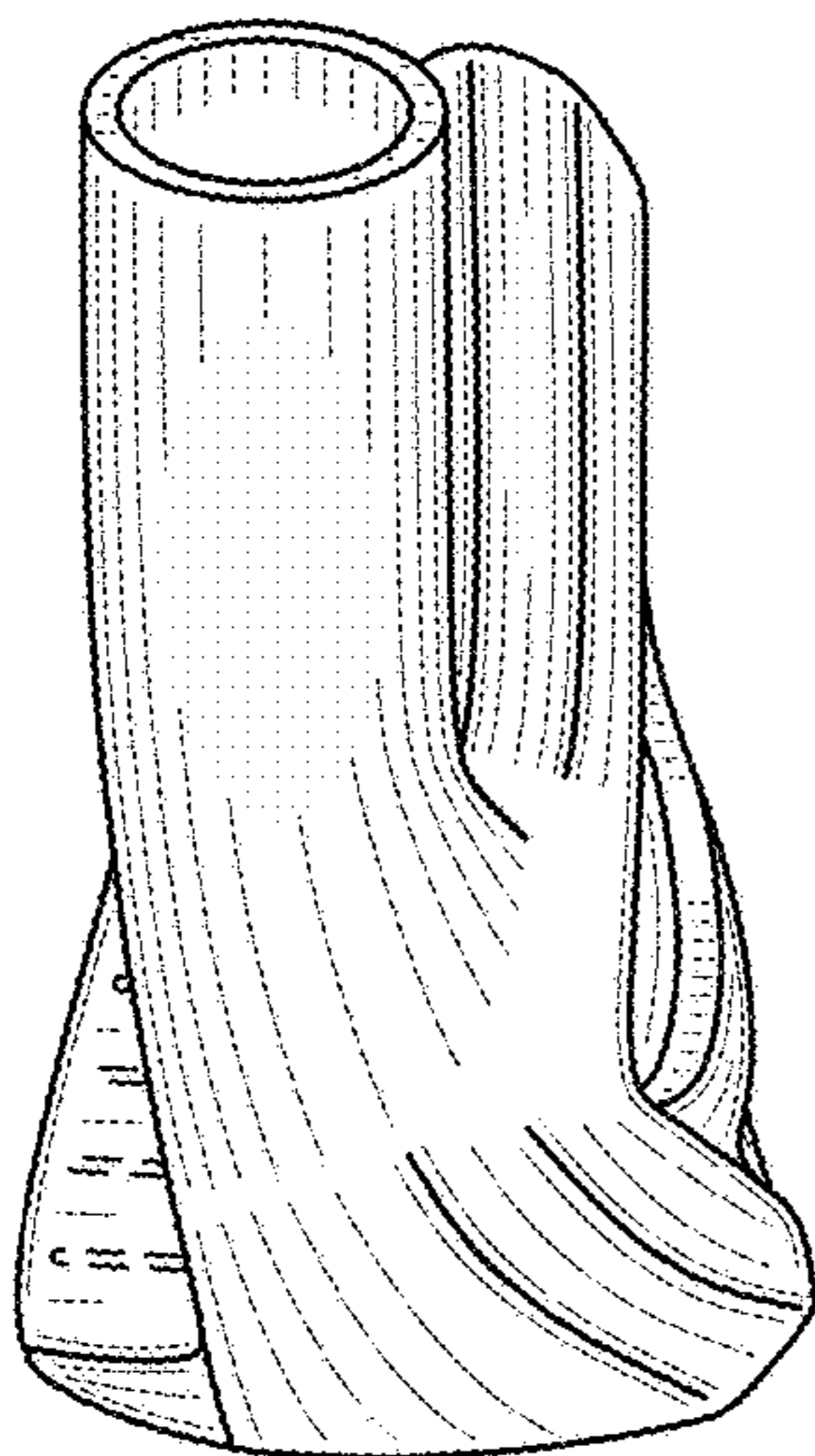

FIG. 7

