



US00D797222S

(12) **United States Design Patent**
Serrano et al.

(10) **Patent No.:** **US D797,222 S**

(45) **Date of Patent:** **** Sep. 12, 2017**

(54) **GOLF CLUB HEAD**

(71) Applicant: **KARSTEN MANUFACTURING CORPORATION**, Phoenix, AZ (US)

(72) Inventors: **Anthony Serrano**, Anthem, AZ (US);
Xiaojian Chen, Phoenix, AZ (US);
Calvin Wang, Chandler, AZ (US);
David Higdon, Phoenix, AZ (US)

(73) Assignee: **Karsten Manufacturing Corporation**, Phoenix, AZ (US)

(**) Term: **15 Years**

(21) Appl. No.: **29/564,649**

(22) Filed: **May 13, 2016**

(51) **LOC (10) Cl.** **21-02**

(52) **U.S. Cl.**
USPC **D21/744**

(58) **Field of Classification Search**
USPC D21/736-746, 759
CPC A63B 53/00; A63B 53/007; A63B 53/065;
A63B 53/0487; A63B 53/04
See application file for complete search history.

(56) **References Cited**

U.S. PATENT DOCUMENTS

3,884,477	A	5/1975	Bianco	
4,030,766	A	6/1977	Derr	
D316,129	S	4/1991	Bryson	
5,275,412	A	1/1994	Innes	
5,685,784	A	11/1997	Butler	
D420,079	S	2/2000	Frazetta	
D425,157	S	* 5/2000	Reed	D21/744
D426,601	S	* 6/2000	Reed	D21/744
D434,821	S	* 12/2000	Farrar	D21/746
6,159,108	A	12/2000	De La Pena	
6,379,259	B1	4/2002	Opie	
D488,526	S	4/2004	Souza	

D491,991	S	* 6/2004	Friebus	D21/738
D500,109	S	12/2004	Solheim	
D500,110	S	12/2004	Solheim	
6,837,801	B1	1/2005	Souza	
6,878,071	B1	4/2005	Schwieger	
6,893,355	B2	5/2005	Souza	
6,902,496	B2	6/2005	Solheim	
D507,612	S	7/2005	Souza	
6,926,615	B1	8/2005	Souza	

(Continued)

Primary Examiner — Mitchell Siegel

(57) **CLAIM**

The ornamental design for a golf club head, as shown and described.

DESCRIPTION

FIG. 1 is a front perspective view of a golf club head;
 FIG. 2 is a rear perspective view of the golf club head of FIG. 1;
 FIG. 3 is a front view of the golf club head of FIG. 1;
 FIG. 4 is a rear view of the golf club head of FIG. 1;
 FIG. 5 is a top view of the golf club head of FIG. 1;
 FIG. 6 is a bottom view of the golf club head of FIG. 1;
 FIG. 7 is a toe view of the golf club head of FIG. 1;
 FIG. 8 is a heel view of the golf club head of FIG. 1;
 FIG. 9 is a front perspective view of a second embodiment of the golf club head;
 FIG. 10 is a rear perspective view of the golf club head of FIG. 9;
 FIG. 11 is a front view of the golf club head of FIG. 9;
 FIG. 12 is a rear view of the golf club head of FIG. 9;
 FIG. 13 is a top view of the golf club head of FIG. 9;
 FIG. 14 is a bottom view of the golf club head of FIG. 9;
 FIG. 15 is a toe view of the golf club head of FIG. 9; and,
 FIG. 16 is a heel view of the golf club head of FIG. 9.
 The broken lines shown in one or more of the figures are for illustrative purposes only and form no part of the claimed design.

1 Claim, 10 Drawing Sheets

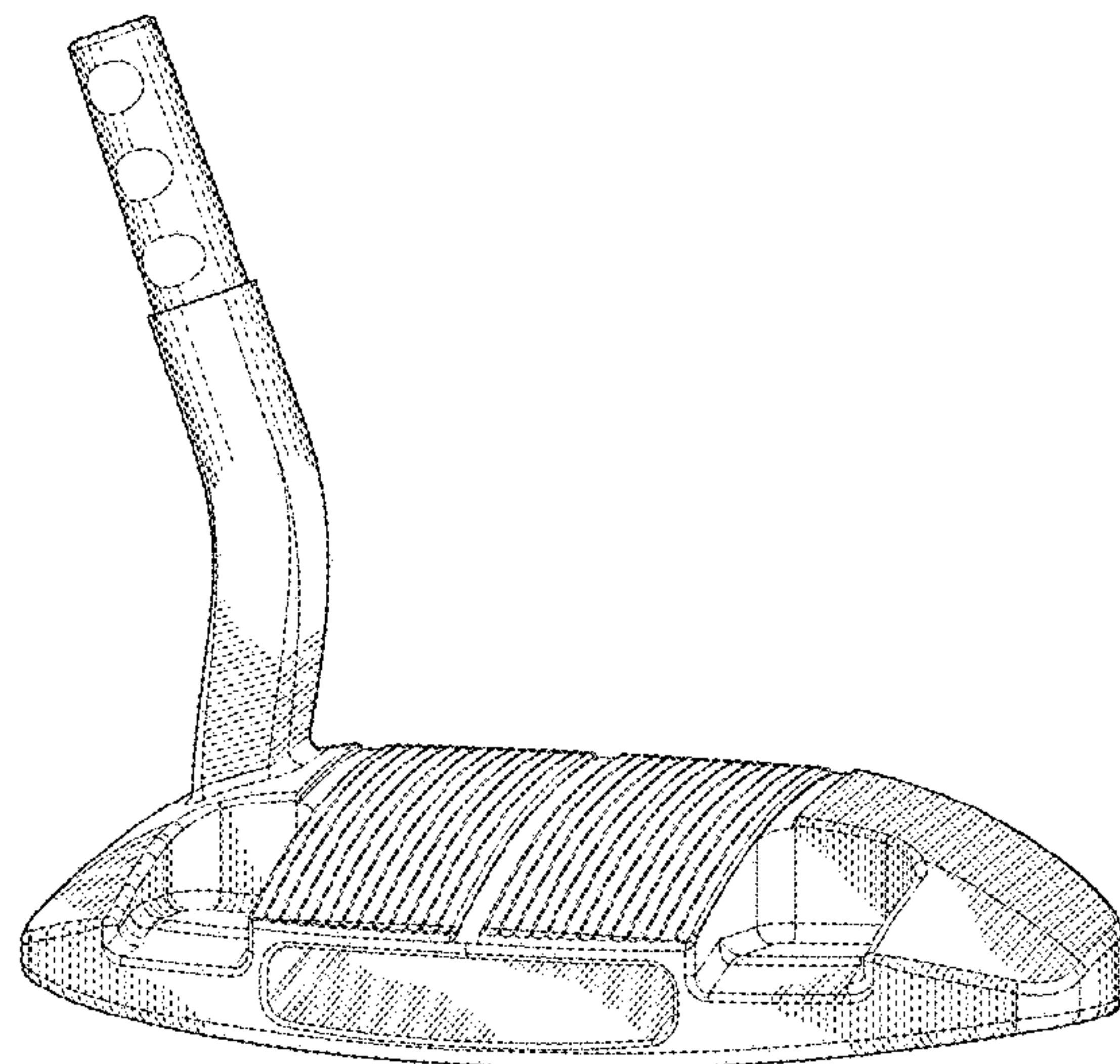
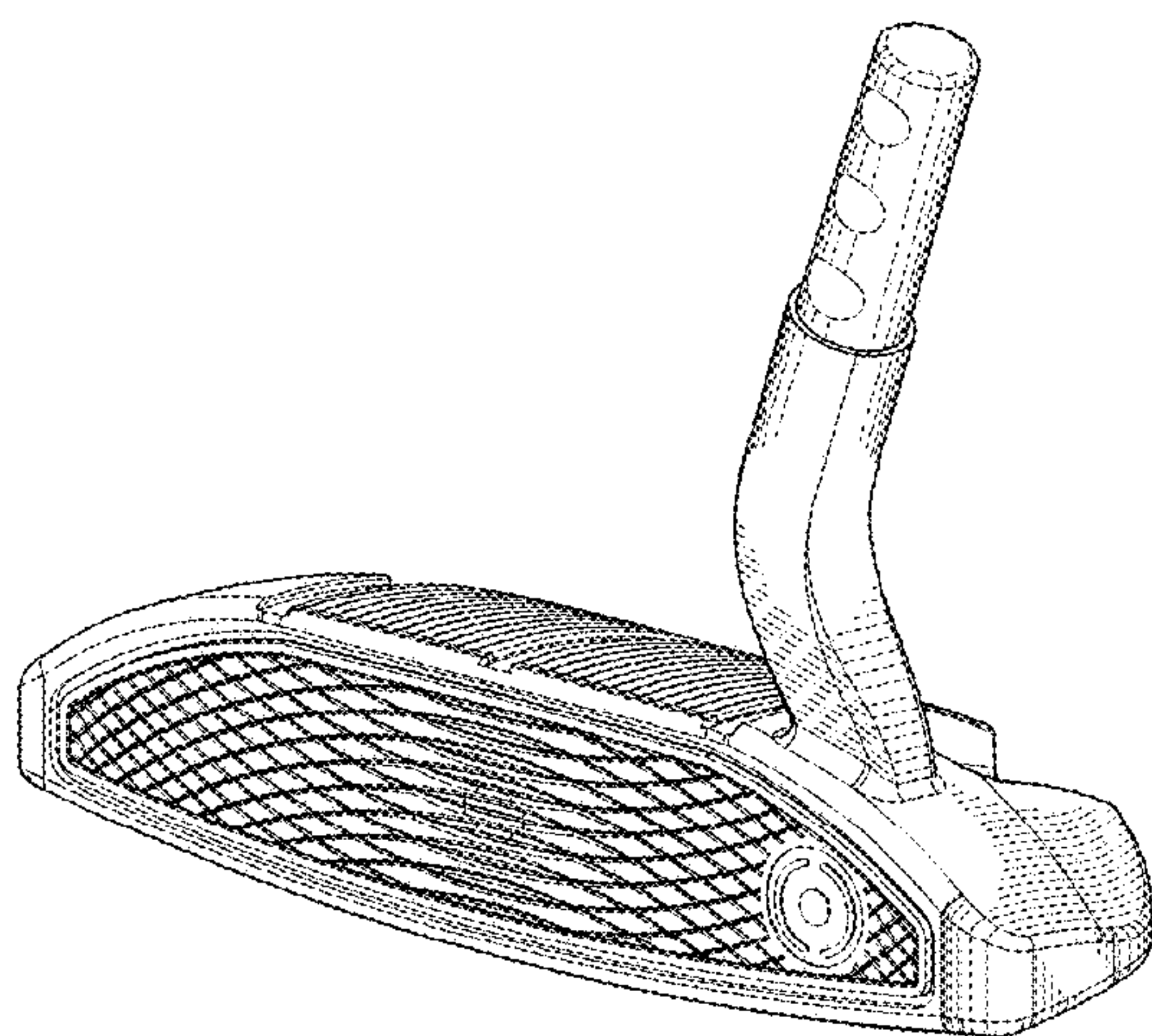

(56)

References Cited

U.S. PATENT DOCUMENTS

6,960,140 B2 11/2005 Solheim
 6,966,845 B2 11/2005 Solheim
 D520,584 S 5/2006 Karlsten
 D521,582 S 5/2006 Souza
 7,052,411 B2 5/2006 Solheim
 D522,598 S 6/2006 Solheim
 7,077,758 B2 7/2006 Rohrer
 7,086,957 B2 8/2006 Solheim
 D527,777 S 9/2006 Solheim
 D529,108 S 9/2006 Stites
 D532,847 S 11/2006 Rollinson
 D533,243 S 12/2006 Fife
 7,235,021 B2 6/2007 Solheim
 D548,295 S 8/2007 Jertson
 7,255,650 B2 8/2007 Braynt
 D552,197 S 10/2007 Wells
 D565,137 S 3/2008 Oldknow
 D569,462 S 5/2008 Rollinson
 7,371,185 B1 5/2008 Rohrer
 D581,473 S 11/2008 Thomas
 D583,003 S 12/2008 Solheim
 D587,325 S 2/2009 Solheim
 D591,806 S * 5/2009 Cameron D21/743
 D595,372 S 6/2009 Rollinson
 D600,760 S 9/2009 Serrano
 D600,761 S 9/2009 Solheim
 D600,762 S 9/2009 Serrano
 7,601,076 B2 10/2009 Rollinson
 D607,950 S 1/2010 Souza

D621,458 S 8/2010 Serrano
 D621,460 S 8/2010 Serrano
 D621,461 S 8/2010 Serrano
 D621,462 S 8/2010 Serrano
 D621,891 S 8/2010 Serrano
 7,803,066 B2 9/2010 Solheim
 7,815,515 B1 10/2010 Hunt
 D638,891 S 5/2011 Nicolette
 D640,341 S 6/2011 Foster et al.
 D643,080 S 8/2011 Serrano
 D643,485 S 8/2011 Nicolette
 D643,486 S 8/2011 Serrano
 D643,487 S 8/2011 Serrano
 8,100,779 B2 1/2012 Solheim
 D653,718 S 2/2012 Stokke
 8,109,838 B2 2/2012 Solheim
 8,128,505 B2 3/2012 Tryner et al.
 D664,617 S 7/2012 Serrano
 D715,388 S * 10/2014 Serrano D21/743
 D774,607 S * 12/2016 Serrano D21/743
 D774,610 S * 12/2016 Serrano D21/744
 2005/0170904 A1 8/2005 Smeeth
 2006/0094533 A1 5/2006 Warren
 2006/0166755 A1 7/2006 Brown
 2007/0191135 A1 8/2007 Nilsson
 2008/0096686 A1 4/2008 Bilkhu
 2009/0270198 A1 10/2009 Solheim et al.
 2009/0305806 A1 12/2009 Campadore et al.
 2009/0305807 A1 12/2009 Solheim et al.
 2010/0227704 A1 9/2010 Souza
 2012/0115628 A1 5/2012 Woods

* cited by examiner

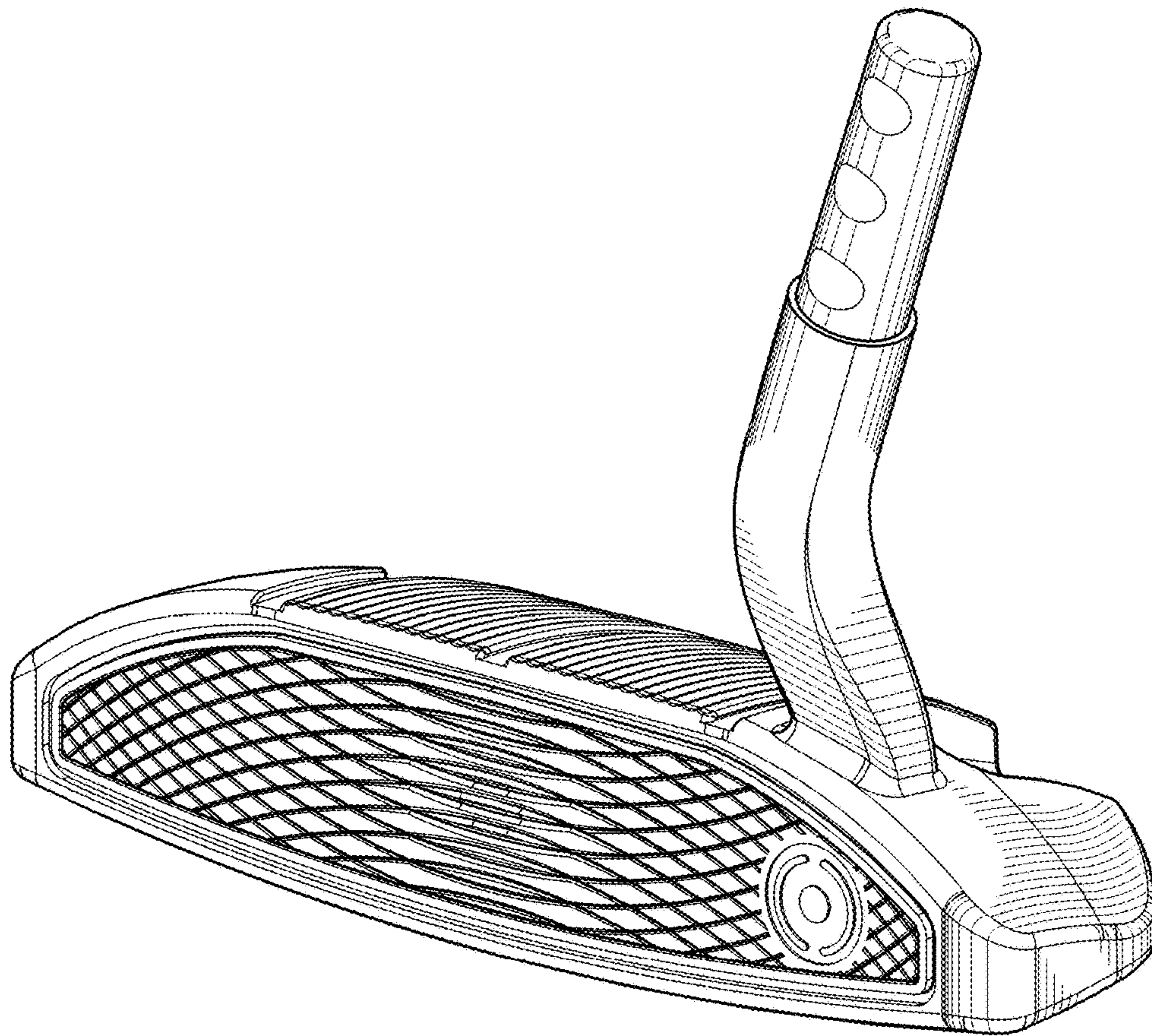

Fig. 1



Fig. 2

Fig. 3

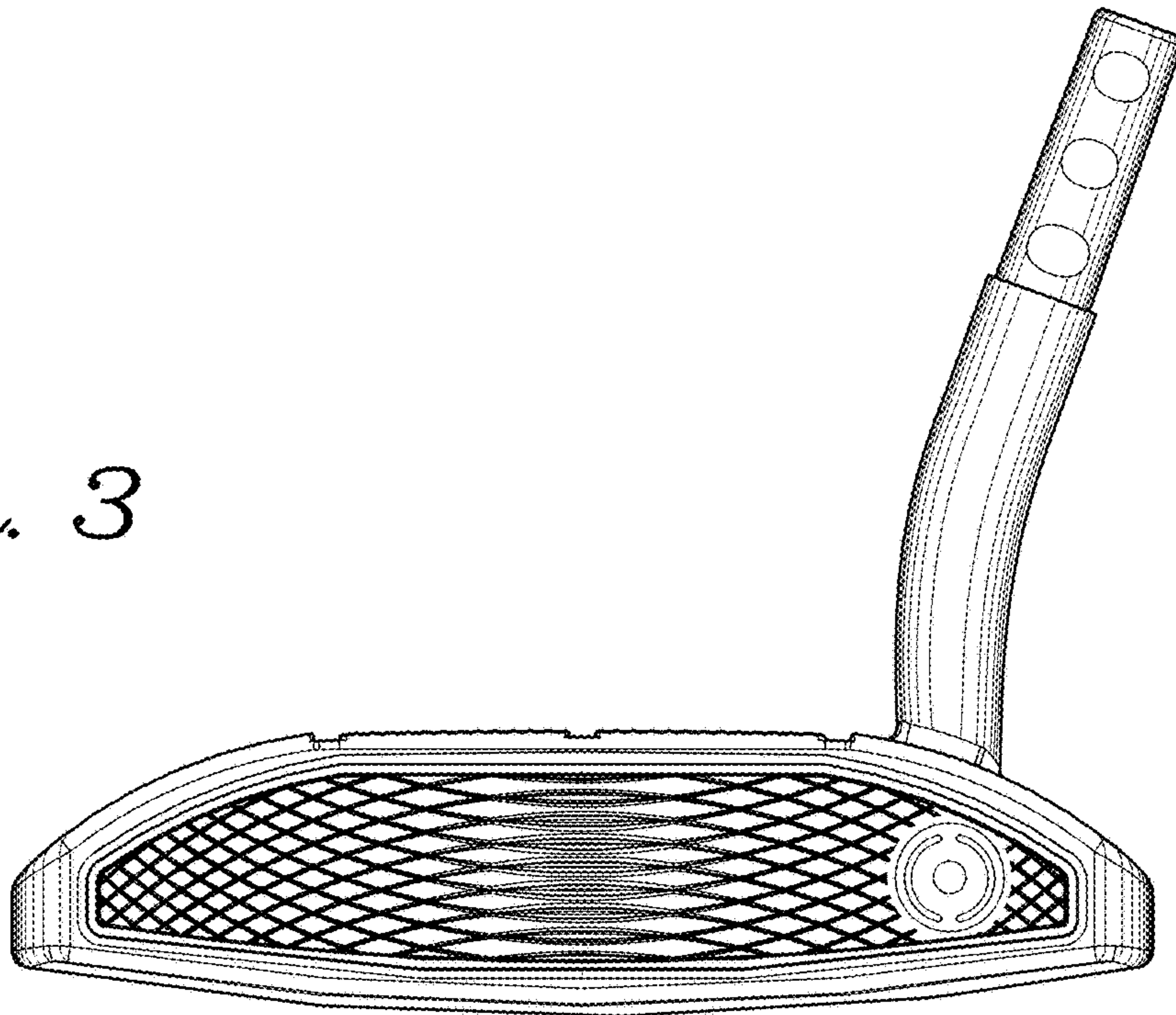
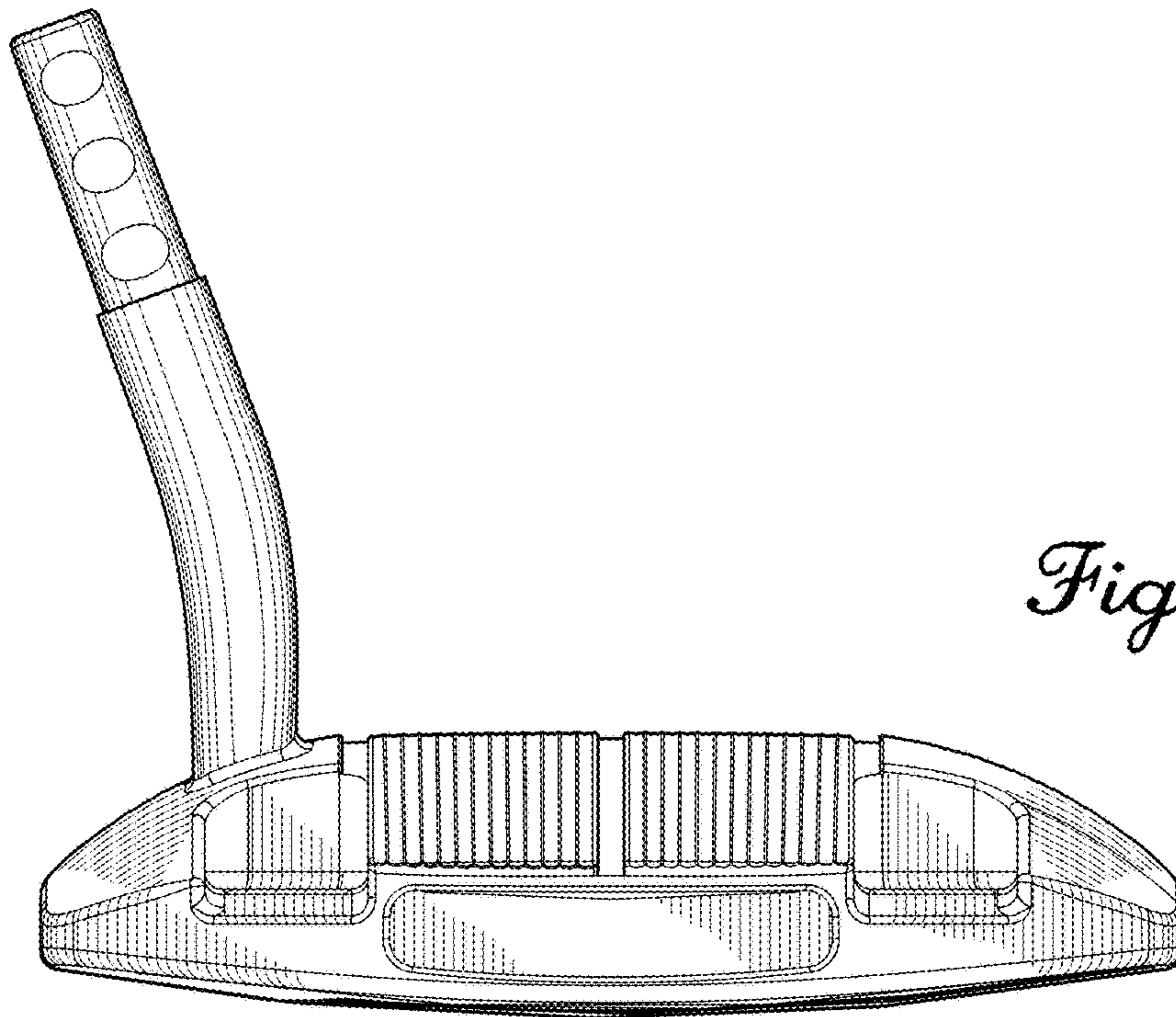

Fig. 4



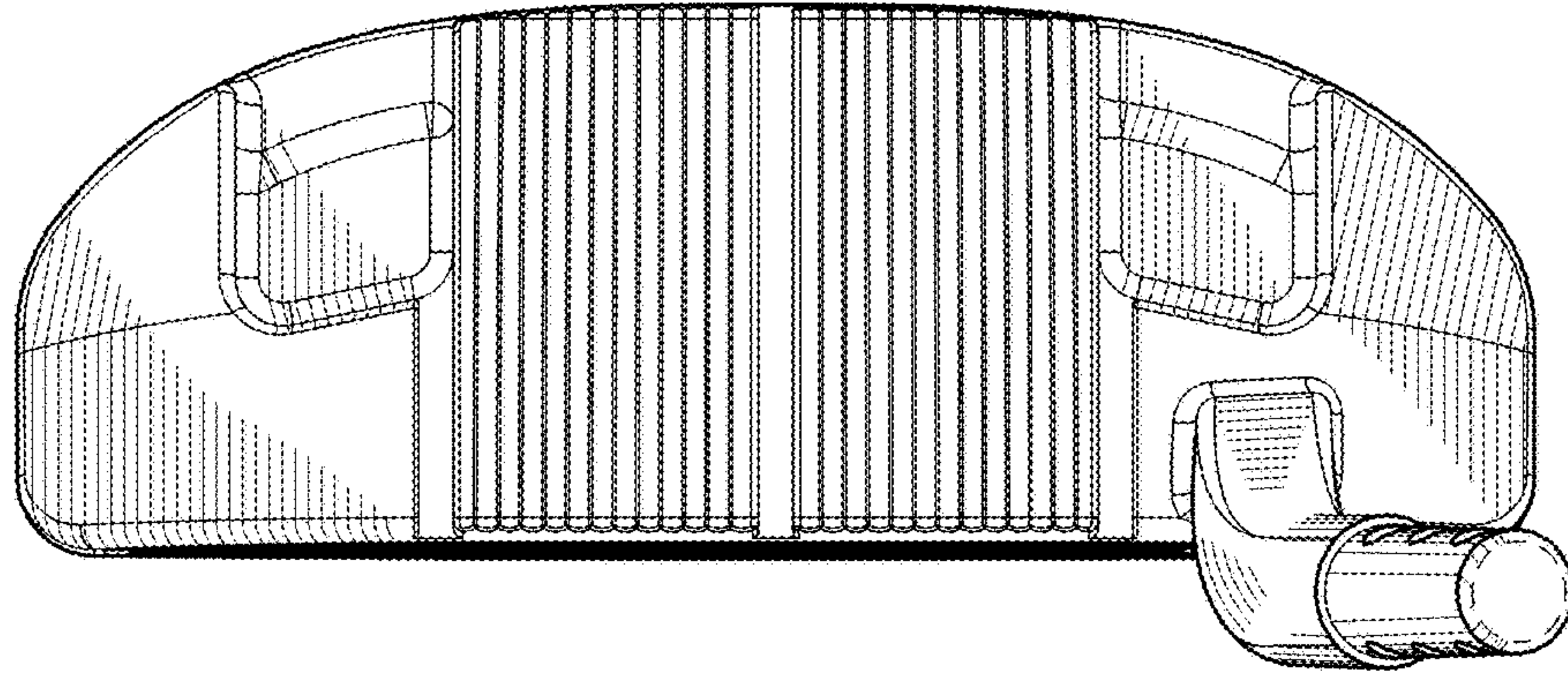

Fig. 5

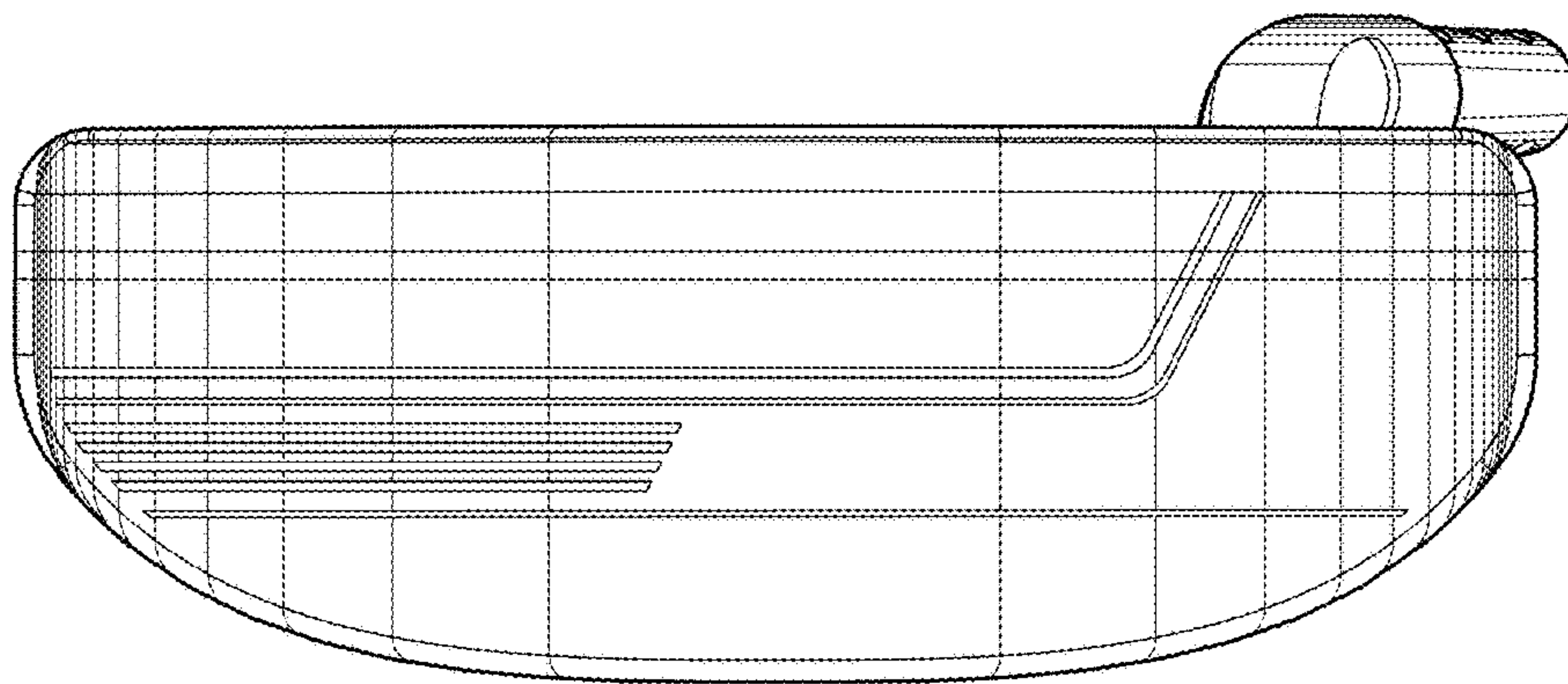

Fig. 6

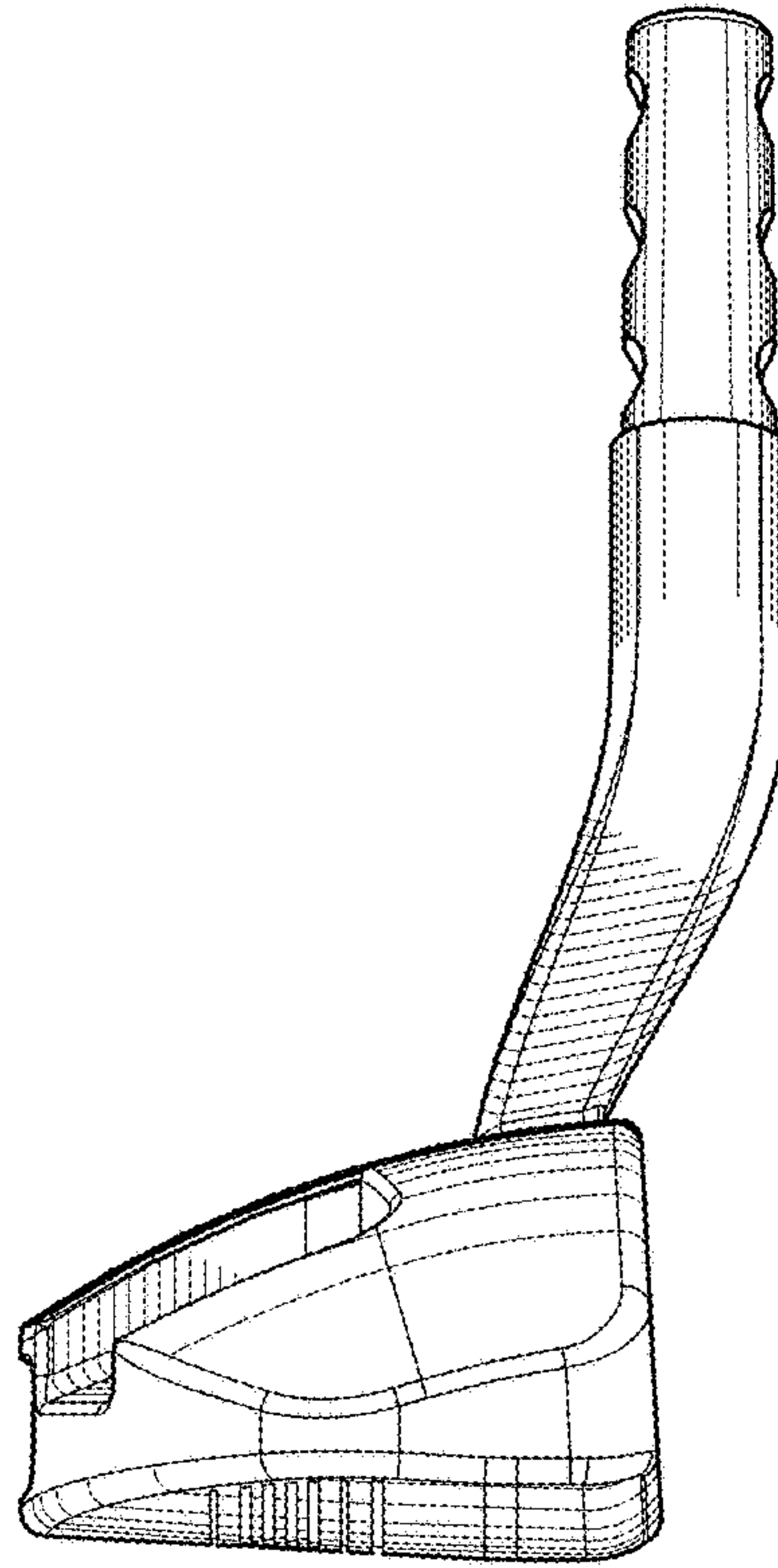

Fig. 7

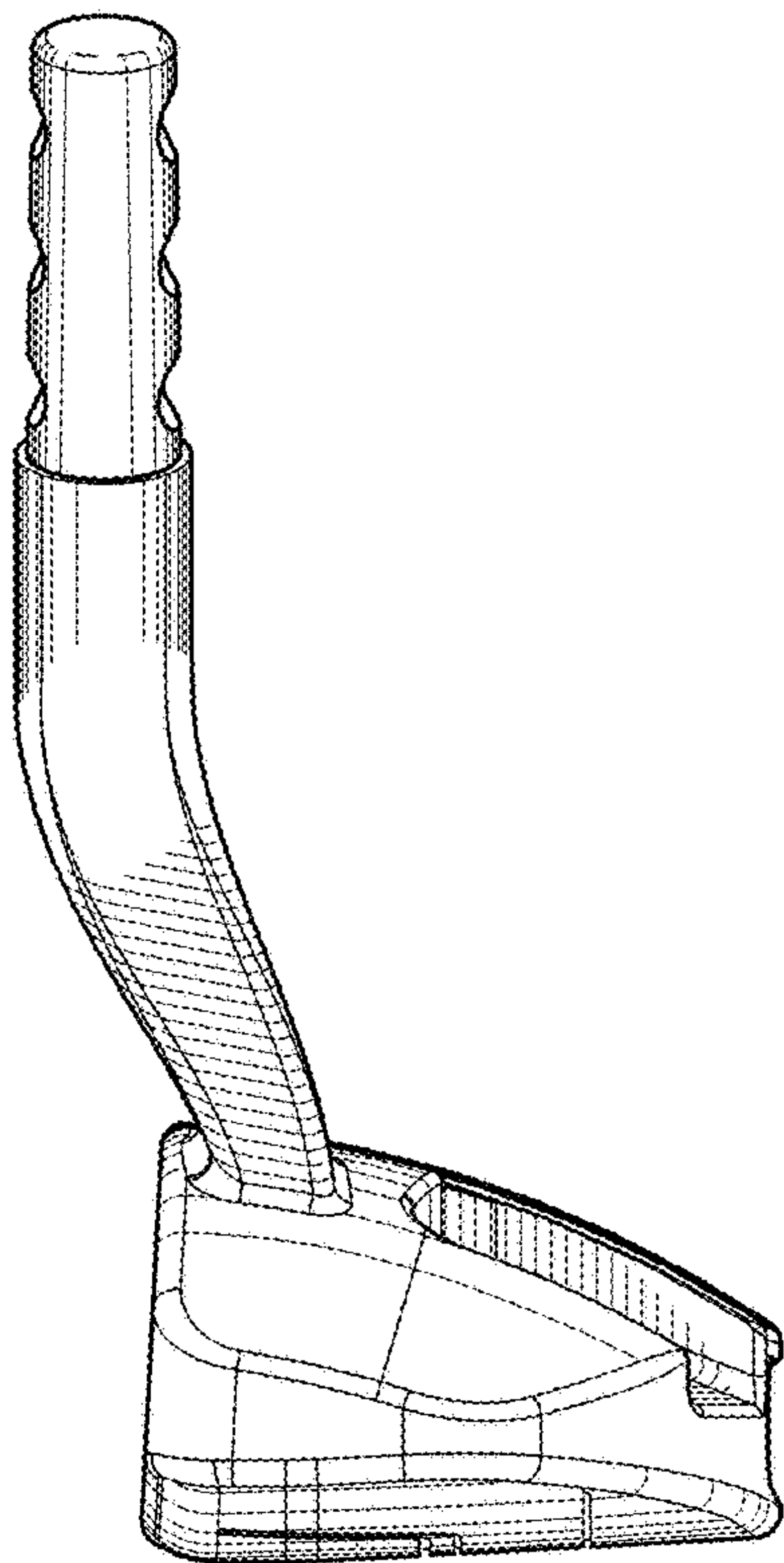

Fig. 8

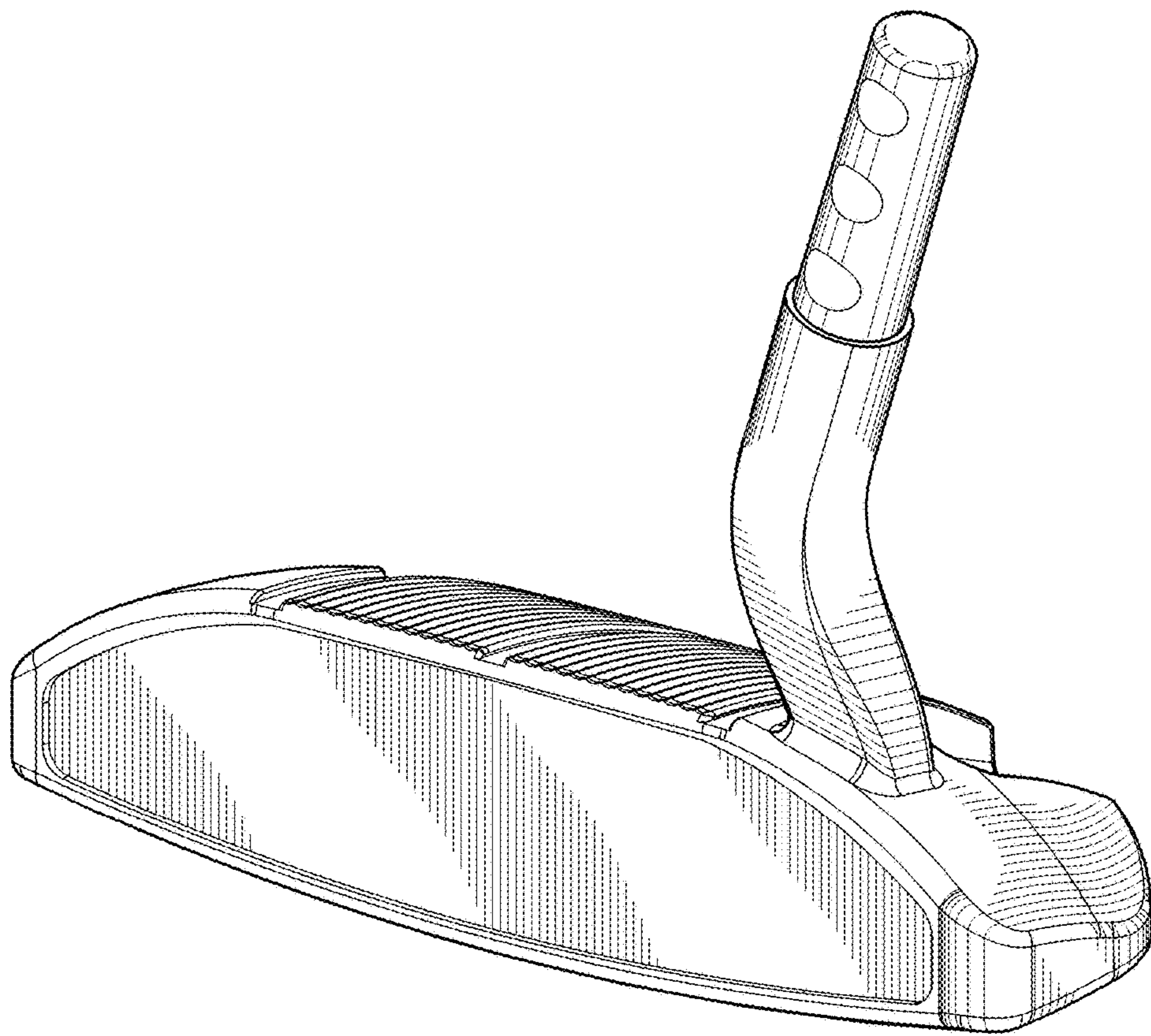

Fig. 9



Fig. 10

Fig. 11

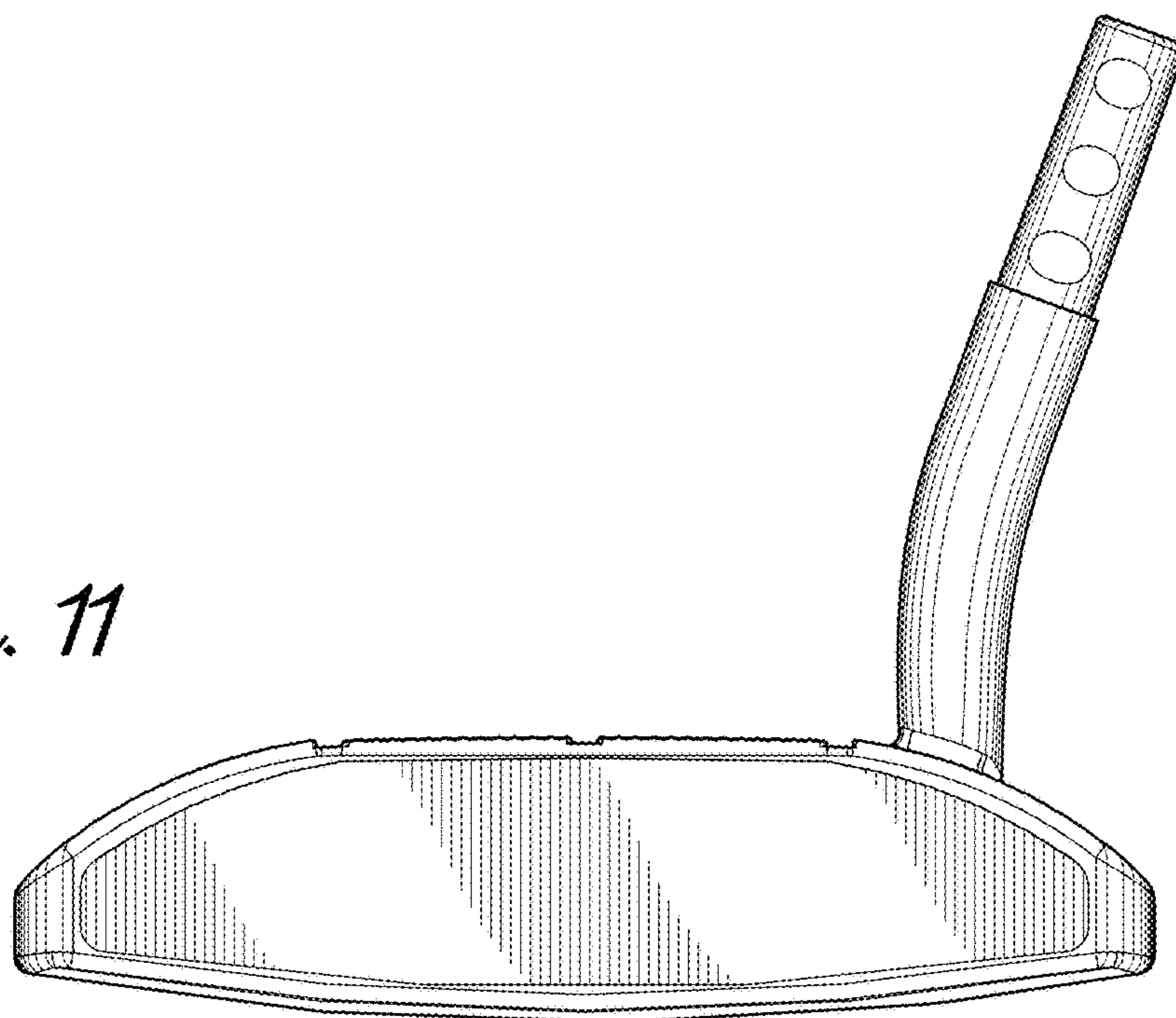
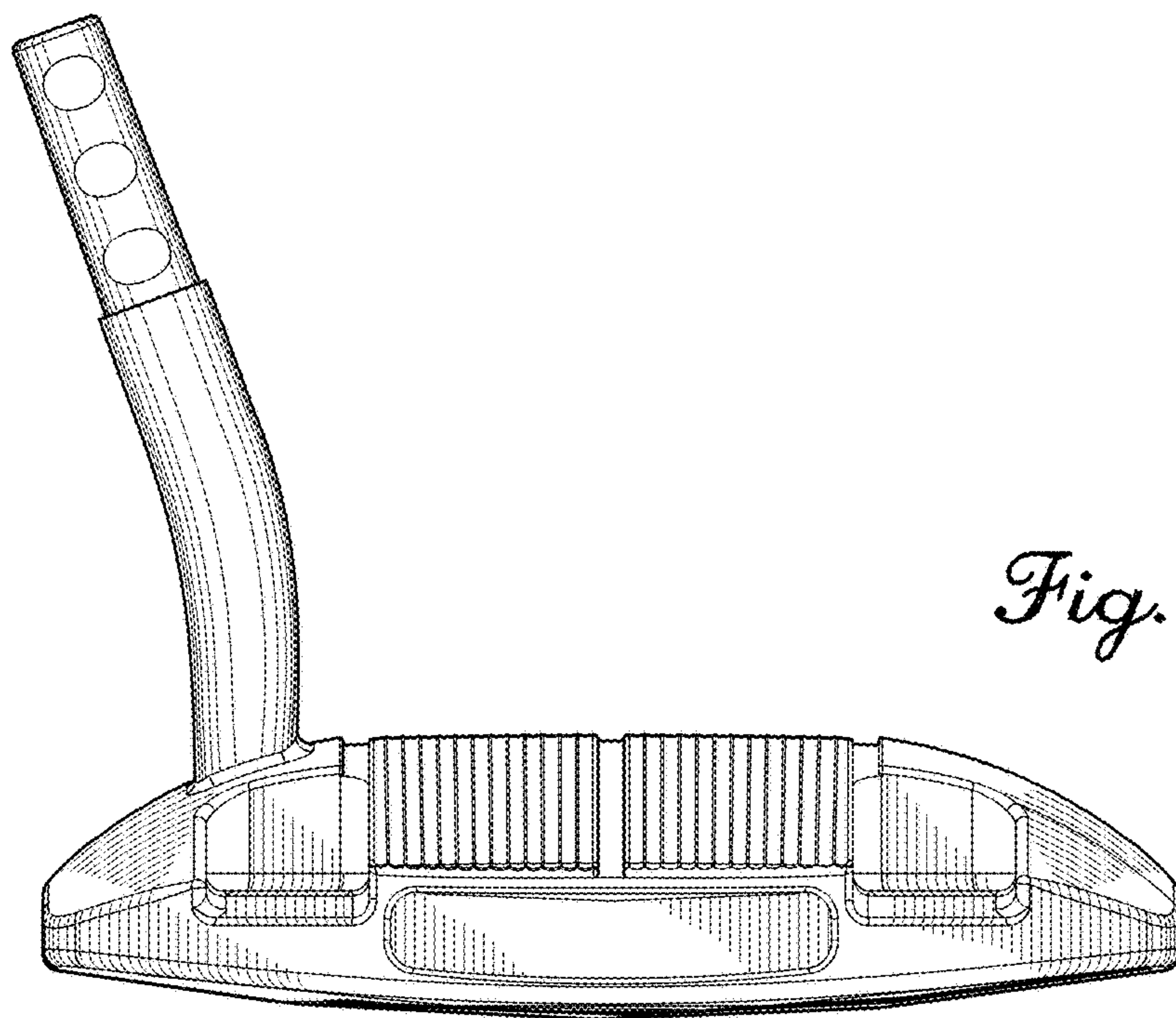

Fig. 12



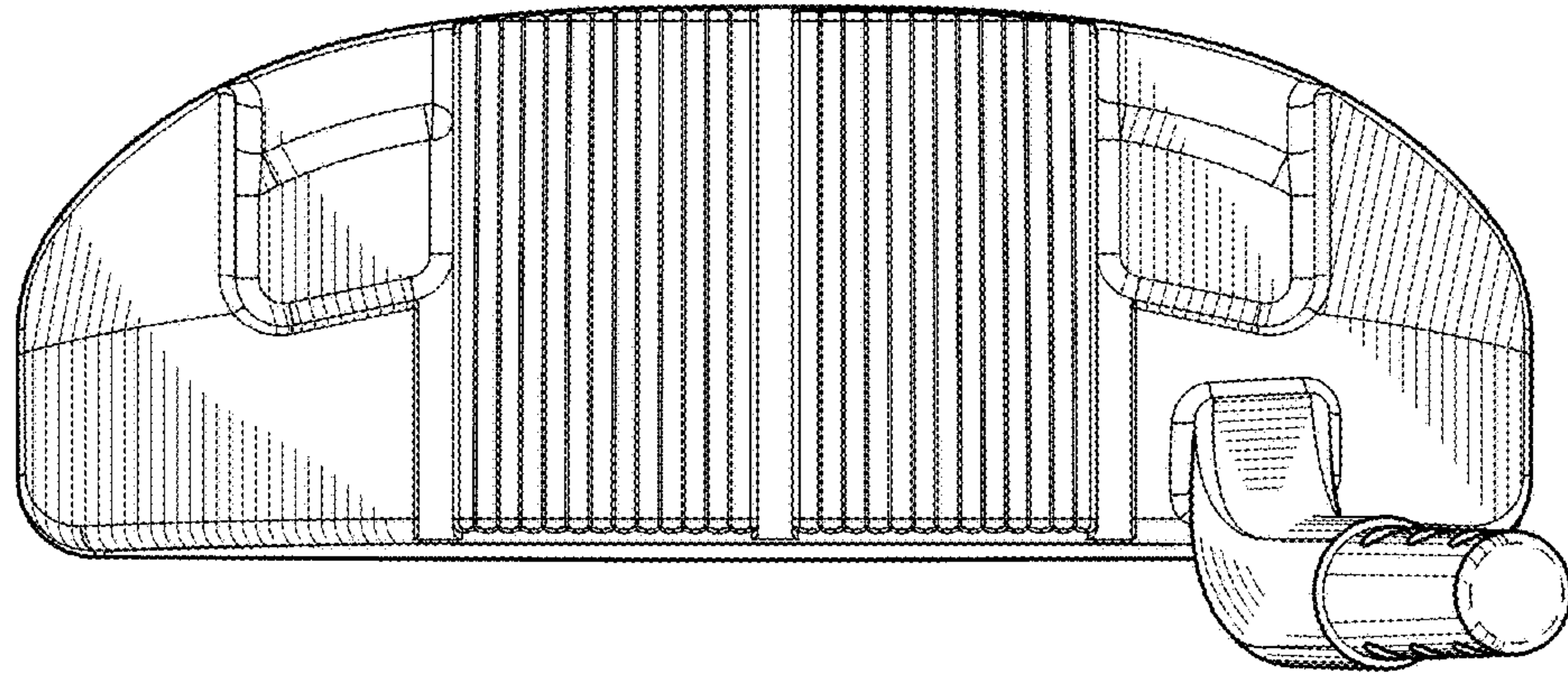

Fig. 13

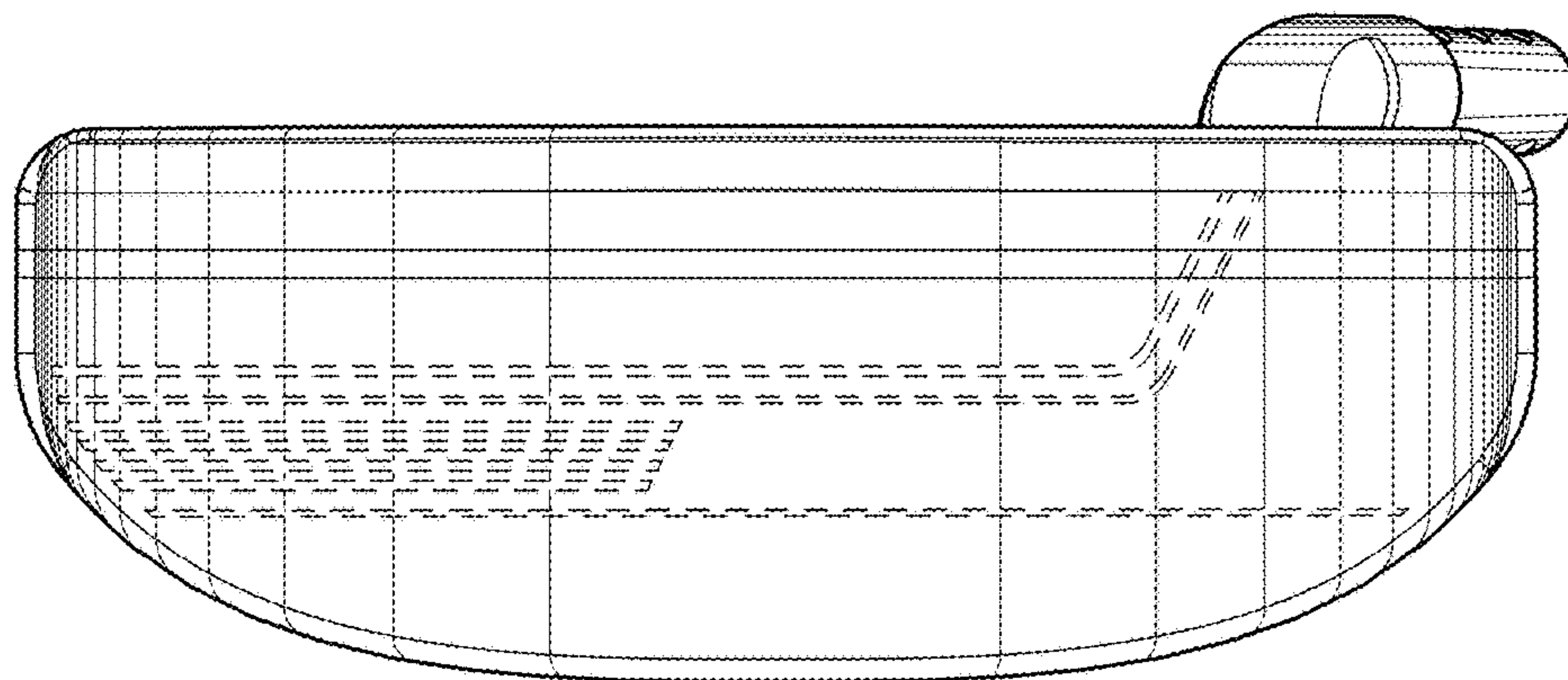

Fig. 14

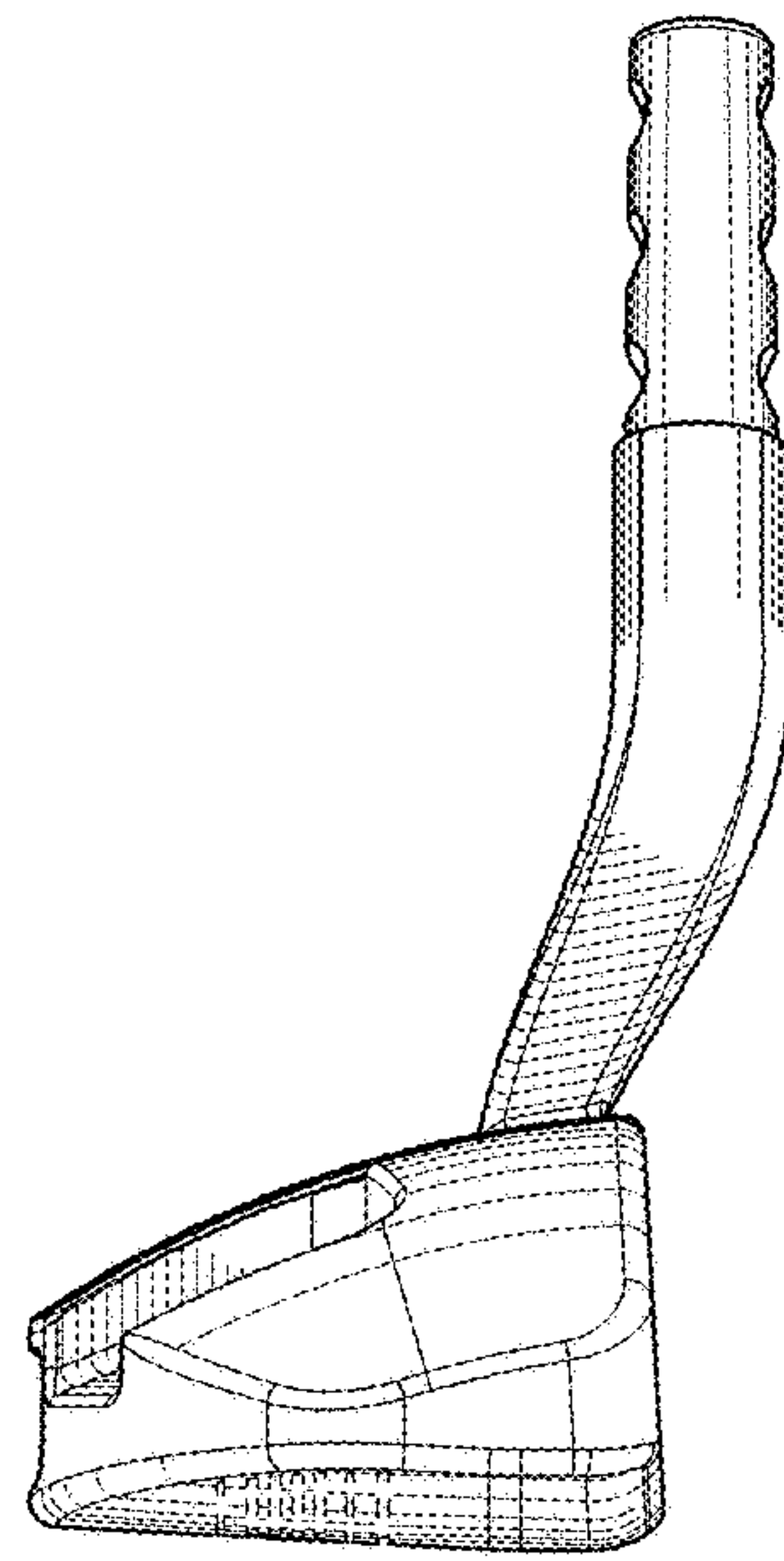

Fig. 15

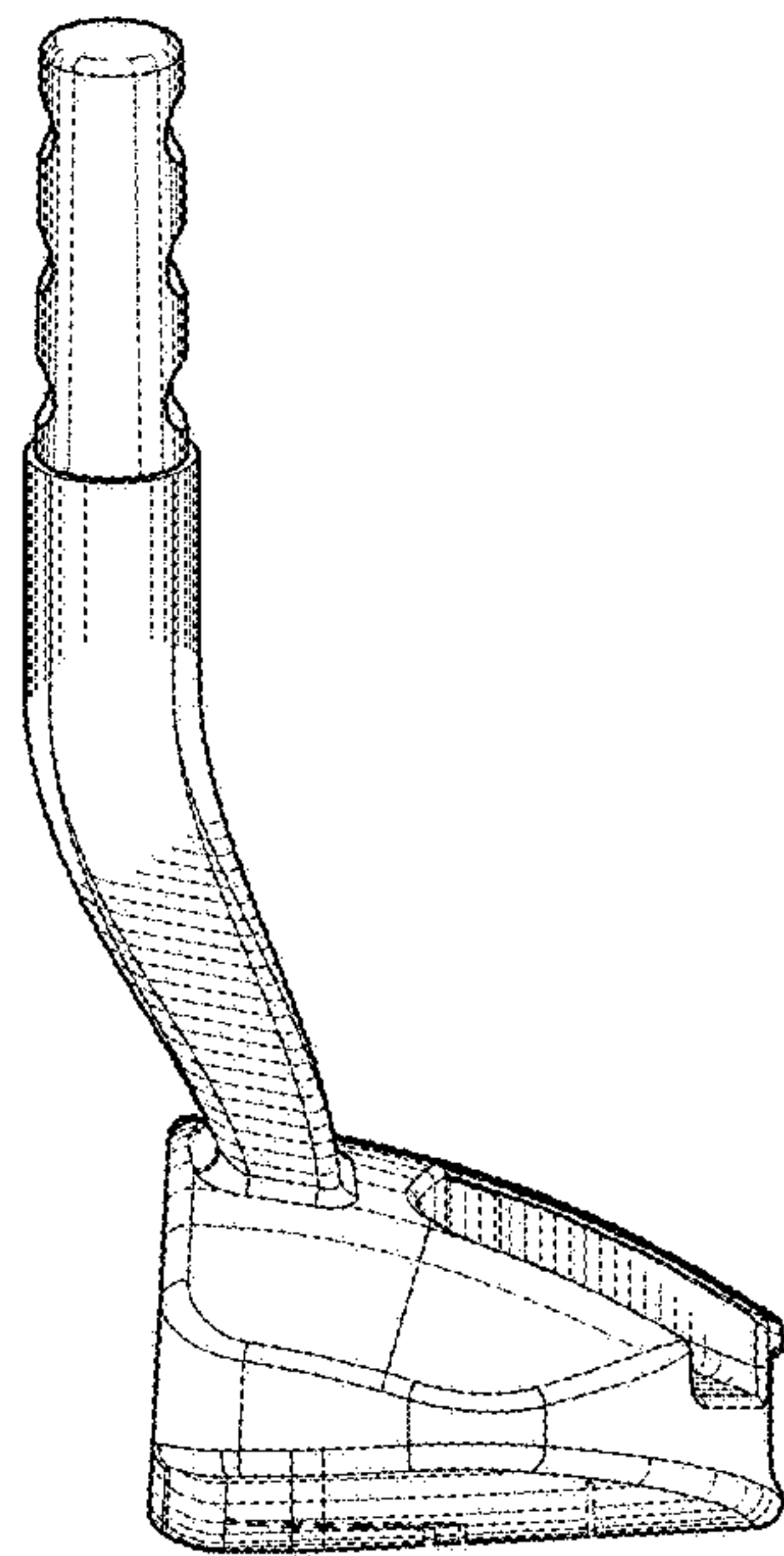

Fig. 16