



US00D797094S

(12) **United States Design Patent** (10) **Patent No.:** **US D797,094 S**  
**Kim** (45) **Date of Patent:** **\*\* Sep. 12, 2017**

(54) **CASE FOR ELECTRONIC DEVICE**

(71) Applicant: **SPIGEN KOREA Co., LTD.**, Seoul (KR)

(72) Inventor: **Dae-Young Kim**, Seoul (KR)

(73) Assignee: **SPIGEN KOREA CO., LTD.**, Geumcheon-Gu, Seoul (KR)

(\*\*) Term: **15 Years**

(21) Appl. No.: **29/569,939**

(22) Filed: **Jul. 1, 2016**

**Related U.S. Application Data**

(63) Continuation of application No. 29/518,091, filed on Feb. 19, 2015.

(51) **LOC (10) Cl.** ..... **14-03**

(52) **U.S. Cl.**  
USPC ..... **D14/250**

(58) **Field of Classification Search**  
USPC ..... D14/143, 189, 203.2–203.7, 217, 238.1, D14/240, 248, 250, 251–253, 440, 447,  
(Continued)

(56) **References Cited**

**U.S. PATENT DOCUMENTS**

D613,761 S \* 4/2010 Jones ..... D14/203.3  
D613,762 S \* 4/2010 Jones ..... D14/203.3  
(Continued)

**OTHER PUBLICATIONS**

<https://www.amazon.com/Spigen-Gunmetal-EXTREME-Protection-Samsung/dp/B00I3UWDV8/> —Available as early as Mar. 9, 2014.\*

(Continued)

*Primary Examiner* — Manpreet Matharu

*Assistant Examiner* — Mojtaba Tehrani

(74) *Attorney, Agent, or Firm* — East West Law Group; Heedong Chae

(57) **CLAIM**

The ornamental design for a case for electronic device, as shown and described.

**DESCRIPTION**

FIG. 1 is a front perspective view of a case for electronic device showing my new design;  
FIG. 2 is a rear perspective view thereof;  
FIG. 3 is a front elevational view thereof;  
FIG. 4 is a rear elevational view thereof;  
FIG. 5 is a left side elevational view thereof;  
FIG. 6 is a right side elevational view thereof;  
FIG. 7 is a top plan view thereof;  
FIG. 8 is a bottom plan view thereof;  
FIG. 9 is a rear perspective view thereof with a support leg extended;  
FIG. 10 is an exploded rear perspective view thereof, showing an inner shell, the support leg, and an outer frame;  
FIG. 11 is a front perspective view of the inner shell of the case;  
FIG. 12 is a rear perspective view of the inner shell of the case;  
FIG. 13 is affront perspective view of the support leg of the case;  
FIG. 14 is a rear perspective view of the support leg of the case;  
FIG. 15 is a front perspective view of the outer frame of the case; and,  
FIG. 16 is a rear perspective view of the outer frame of the case.

The broken line in the figure drawings represents unclaimed environment only and forms no part of the claimed design.

**1 Claim, 16 Drawing Sheets**

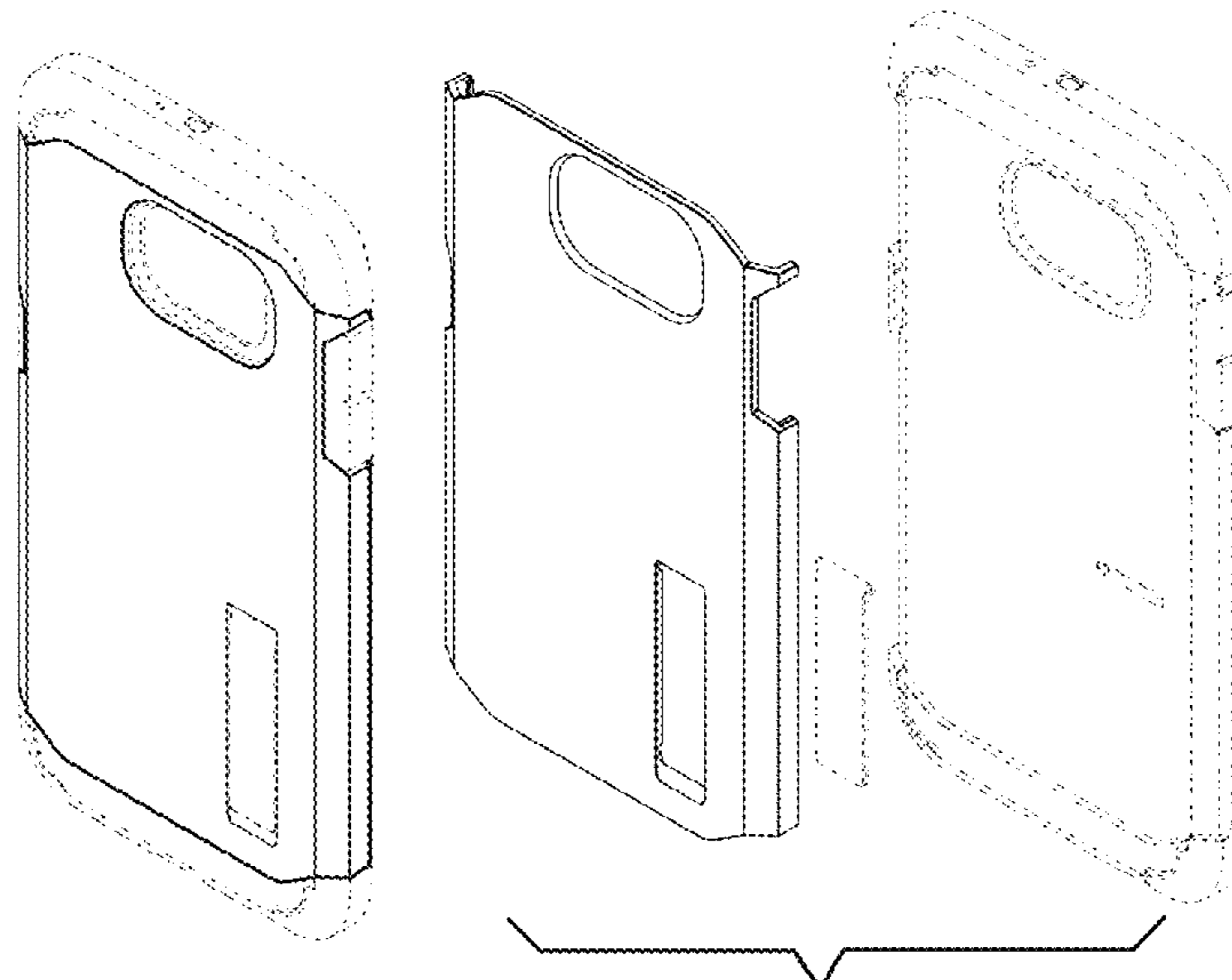

(58) **Field of Classification Search**

USPC ..... D14/496; D13/103, 107–108, 119;  
 D3/201, 218, 247, 269, 273, 301, 303  
 CPC ..... A45C 1/06; A45C 11/00; A45C 13/02;  
 A45C 2011/002; A45F 2005/026; A45F  
 2200/0525; A45F 2200/0516; H04B  
 1/3888; H04M 1/0283; H04M 1/0202  
 See application file for complete search history.

D765,638 S \* 9/2016 Gaylord ..... D14/250  
 D765,640 S \* 9/2016 Bulkley ..... D14/250  
 2011/0050606 A1 3/2011 Zhang  
 2015/0335116 A1 11/2015 Kim

OTHER PUBLICATIONS

[http://www.phonearena.com/reviews/Urban-Armor-Gear-for-Samsung-Galaxy-S6-case-review\\_id4010](http://www.phonearena.com/reviews/Urban-Armor-Gear-for-Samsung-Galaxy-S6-case-review_id4010)—Published May 21, 2015.\*  
<https://www.amazon.com/Supcase-Resistant-Full-body-Protector-Samsung/dp/B013D32WVA/>—Available as early as Aug. 28, 2015.\*  
<http://www.spigen.com/collections/galaxy-s6/products/galaxy-s6-case-tough-armor?variant=1160710157>—Earliest review date of May 12, 2015.  
<http://www.spigen.com/collections/galaxy-s7/products/galaxy-s7-case-tough-armor-1?variant=12163553089>—Product review date of Mar. 8, 2016.  
[http://www.amazon.com/Spigen%C2%AE-Gunmetal-EXTREME-Protection-Protective/dp/B01A7IDNWQ/ref=pd\\_sim\\_107\\_5?ie=UTF8&dpiD=41hi9zQzsuL&dpSrc=sim&preST=\\_AC\\_UL160\\_SR160%2C160\\_&refRID=0YMXPY3N34F4SHH1NNT](http://www.amazon.com/Spigen%C2%AE-Gunmetal-EXTREME-Protection-Protective/dp/B01A7IDNWQ/ref=pd_sim_107_5?ie=UTF8&dpiD=41hi9zQzsuL&dpSrc=sim&preST=_AC_UL160_SR160%2C160_&refRID=0YMXPY3N34F4SHH1NNT)—Earliest review date of Feb. 17, 2016.  
 Otterbox, Otterbox Symmetry Case for Galaxy S4, downloaded on Feb. 13, 2017, pp. 1-5, Daily Steals, <https://www.dailysteals.com/products/otterbox-symmetry-case-for-galaxy-s4?variant=21478214916>.  
 Urban Armour Gear, UAG Protective Case for Samsung Galaxy S4—Aero—Blue, downloaded on Feb. 13, 2017, pp. 1-3, Mobile Fun Limited, <http://www.mobile/fun.co.uk/uag-protectiive-case-for-samsung-galaxy-s4-aero-blue-p39601.htm>.  
 Seth, Radhika, IFace Sensationalize Samsung Galaxy S4, May 27, 2013, downloaded Feb. 13, 2017, pp. 1-11, Yanko Design, <http://www.yankodesign.com/2013/05/27/iface-sensationalize-samsung-galaxy-s4/>.

\* cited by examiner

(56) **References Cited**

U.S. PATENT DOCUMENTS

D613,763 S \* 4/2010 Jones ..... D14/203.3  
 D614,668 S \* 4/2010 Jones ..... D14/203.7  
 D619,361 S 7/2010 Andre  
 D646,265 S 10/2011 Fathollahi  
 D676,035 S 2/2013 Chang  
 D681,615 S 5/2013 Fathollahi  
 8,517,172 B1 8/2013 Chang  
 8,706,176 B1 4/2014 Jia  
 D706,254 S 6/2014 Chang  
 D709,871 S 7/2014 Lee  
 D721,071 S \* 1/2015 Nelson ..... D14/250  
 9,049,283 B1 \* 6/2015 Kim ..... H04M 1/21  
 D749,068 S 2/2016 Zaborski  
 D749,535 S 2/2016 Joung  
 D753,099 S \* 4/2016 Kim ..... D14/250  
 D755,764 S 5/2016 Dong  
 D755,772 S 5/2016 Sasaki  
 D756,339 S 5/2016 Tussy  
 D756,340 S \* 5/2016 Babichenko ..... D14/250  
 D756,343 S 5/2016 Wall et al.  
 D756,909 S 5/2016 Gupta  
 D756,977 S \* 5/2016 Schriefer ..... D14/250  
 D756,978 S 5/2016 Addonisio  
 D756,980 S 5/2016 Beeman  
 D757,703 S 5/2016 Kanazawa  
 D759,641 S 6/2016 Lai et al.  
 D762,633 S \* 8/2016 Fife ..... D14/250  
 D765,635 S \* 9/2016 Chang ..... D14/250

FIG. 1

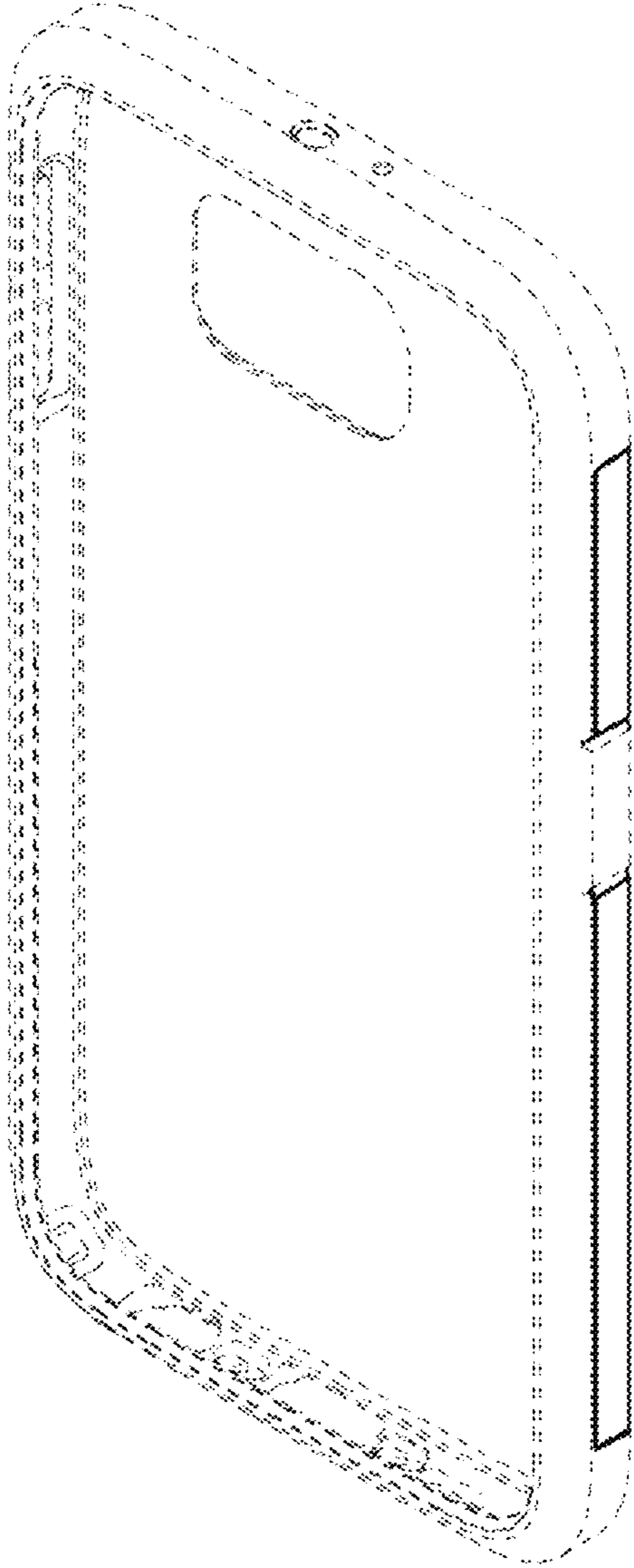

FIG. 2

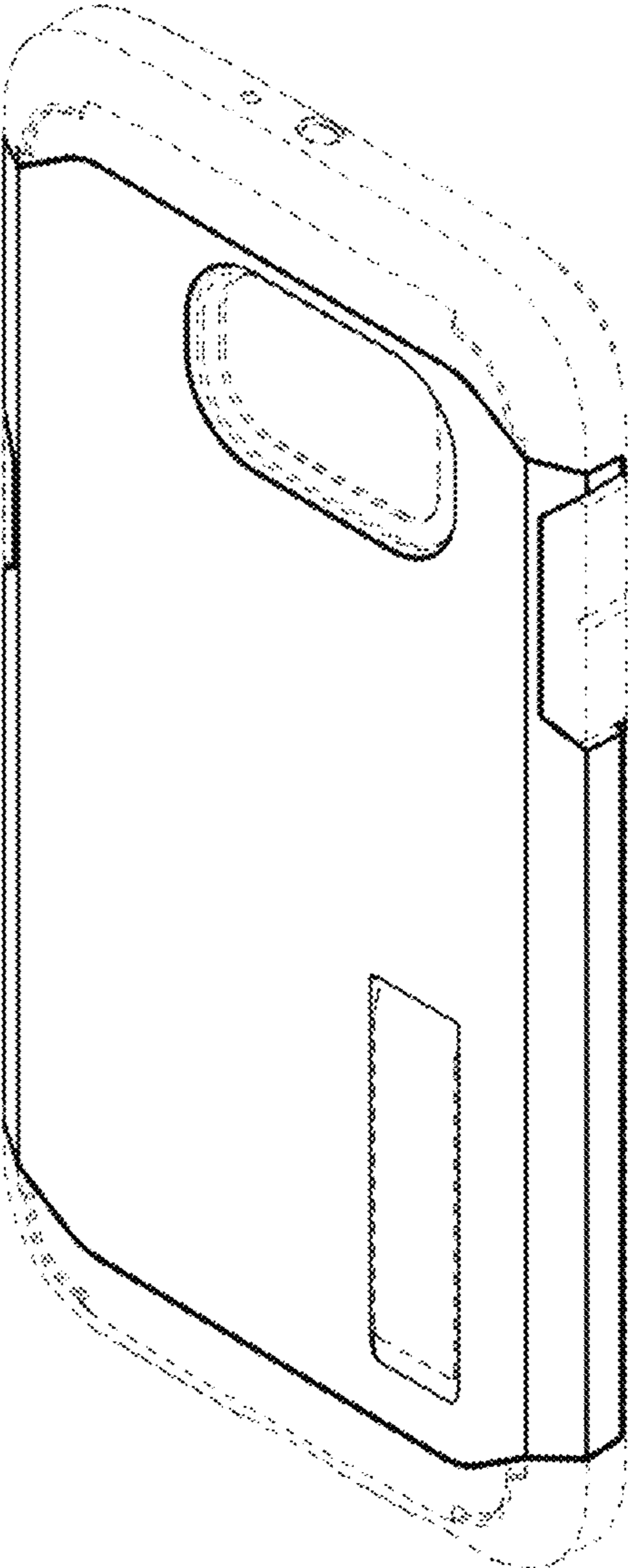

FIG. 3

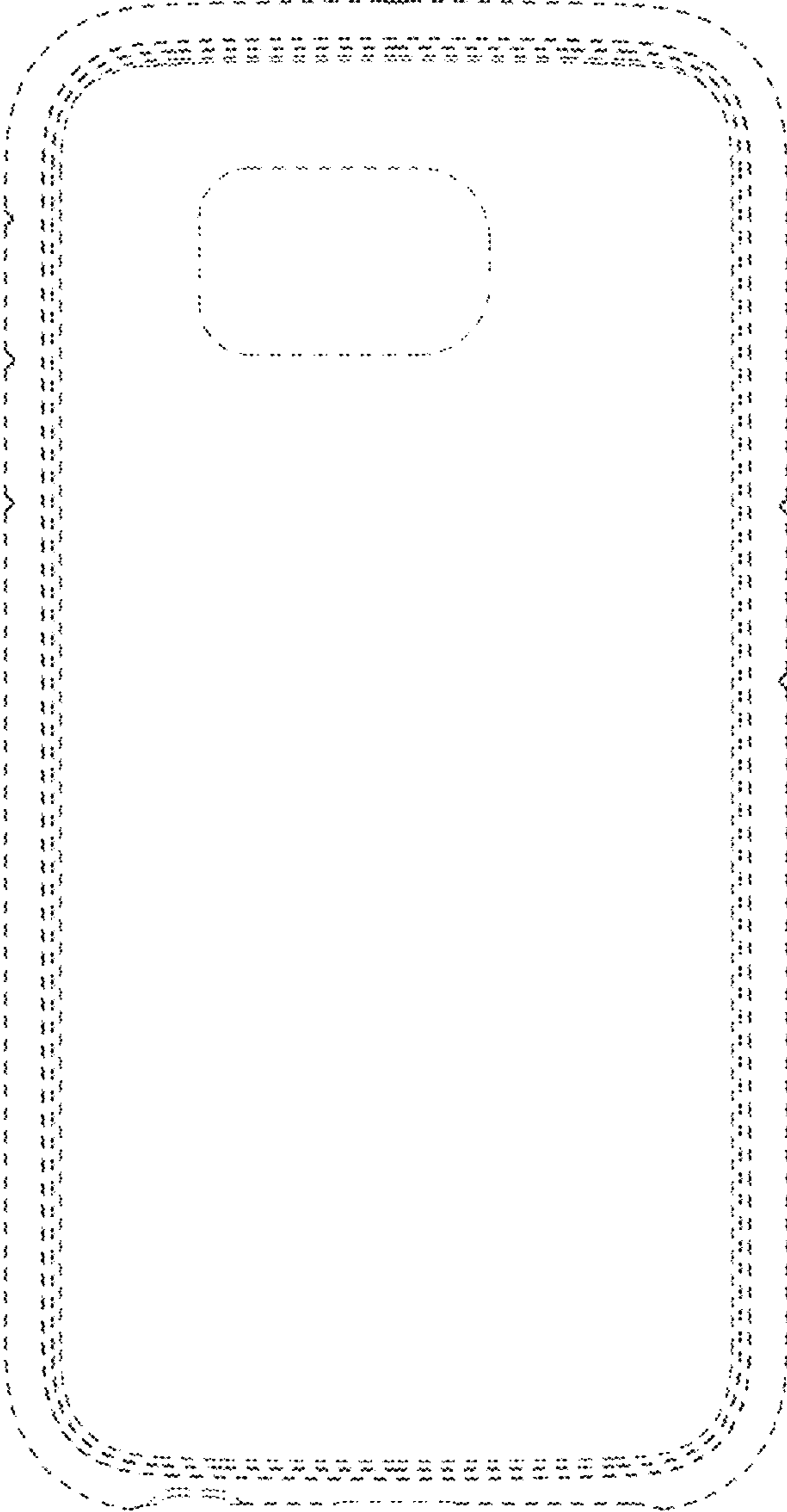

FIG. 4

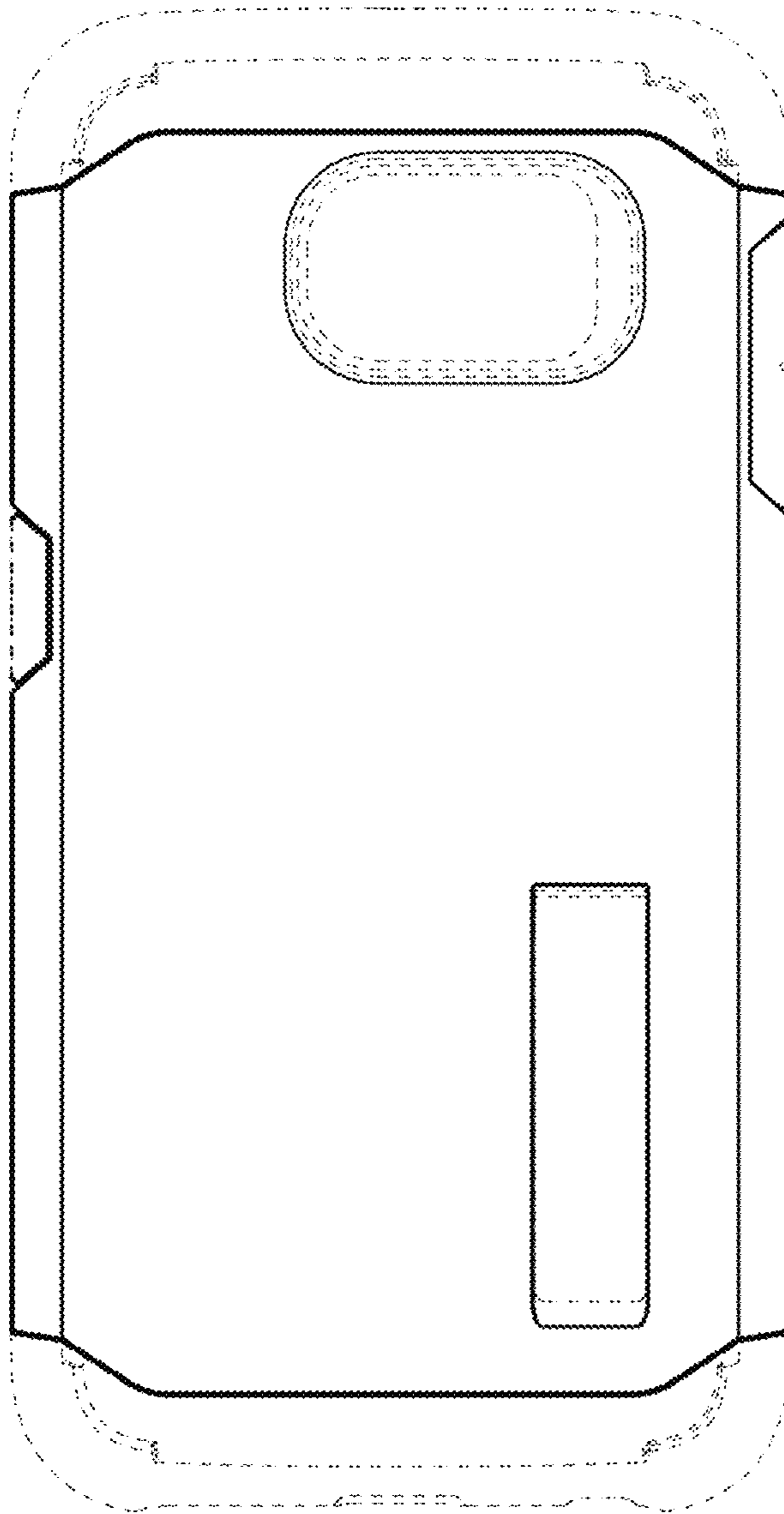

FIG. 5

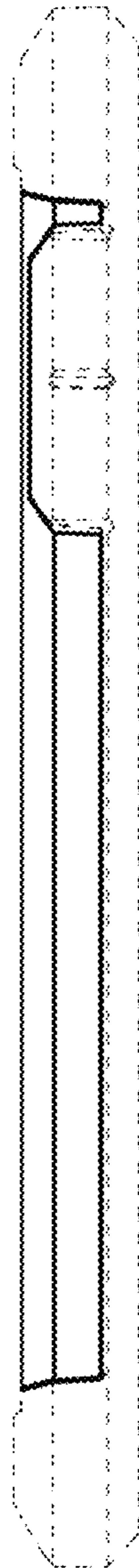

FIG. 6

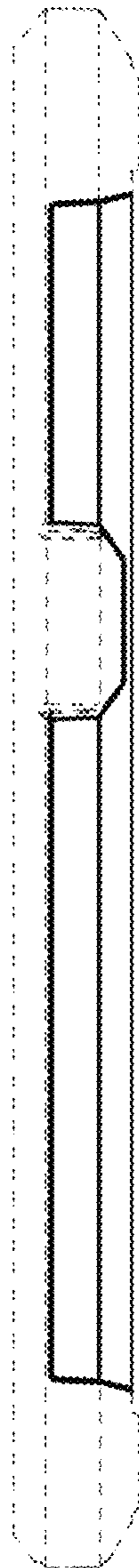



FIG. 7



FIG. 8

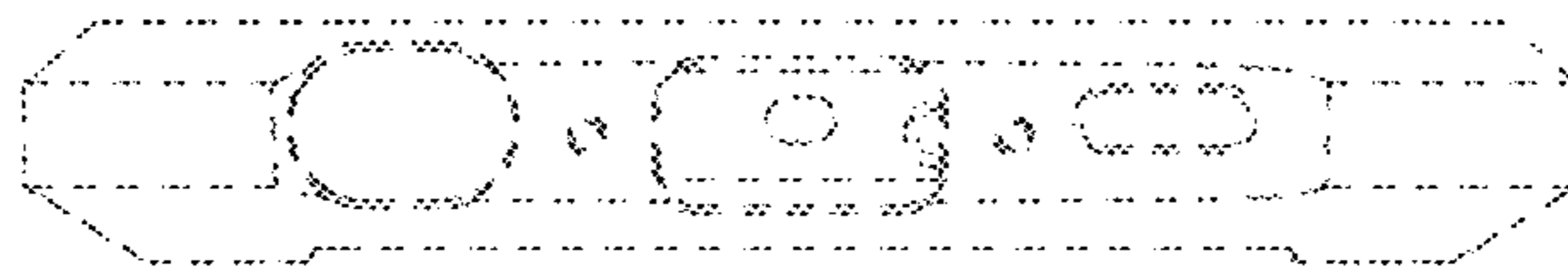

FIG. 9

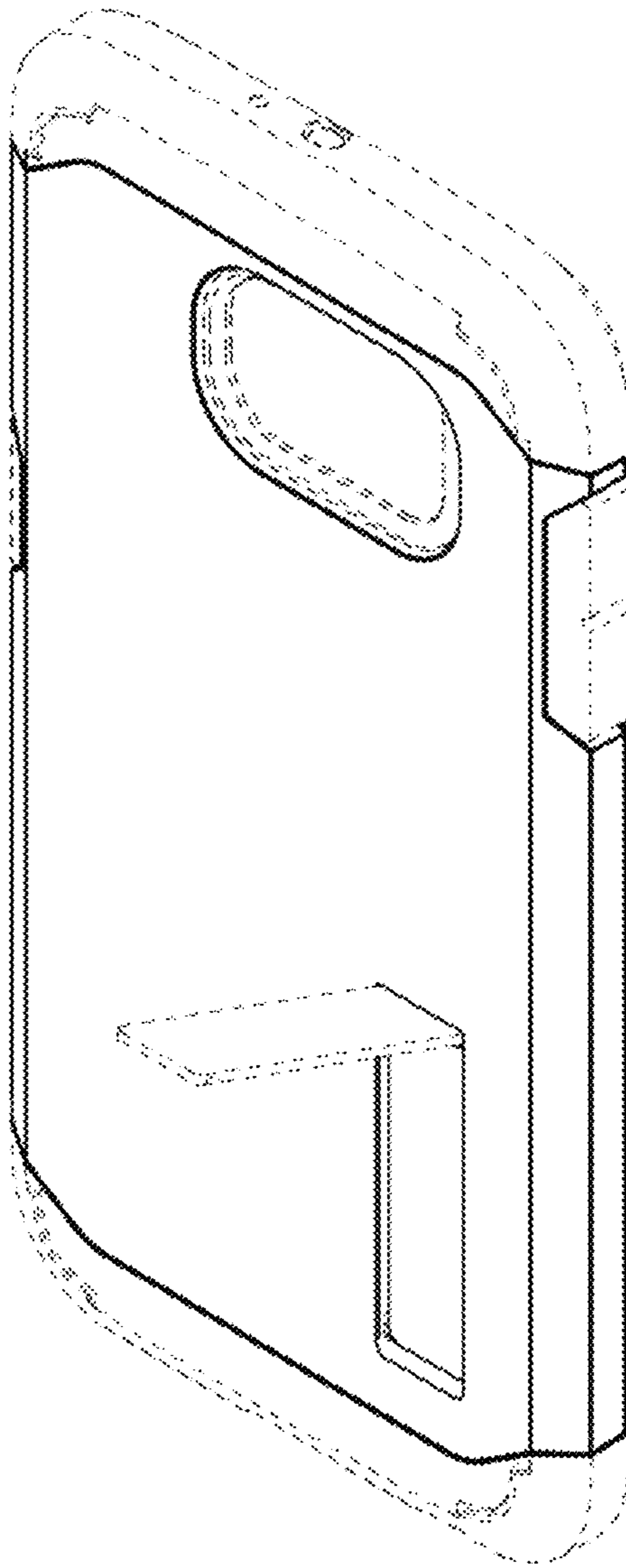

FIG. 10

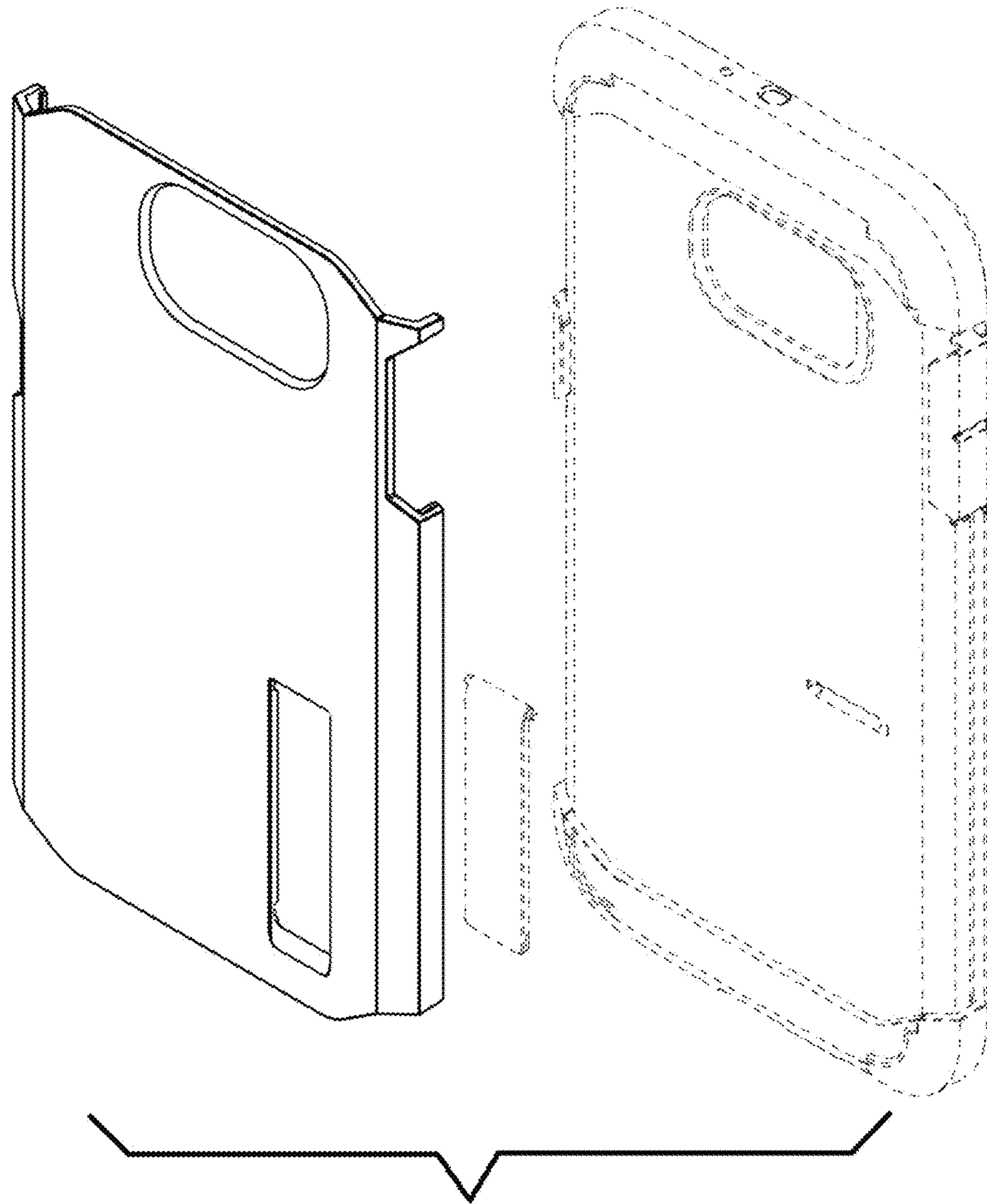

FIG. 11

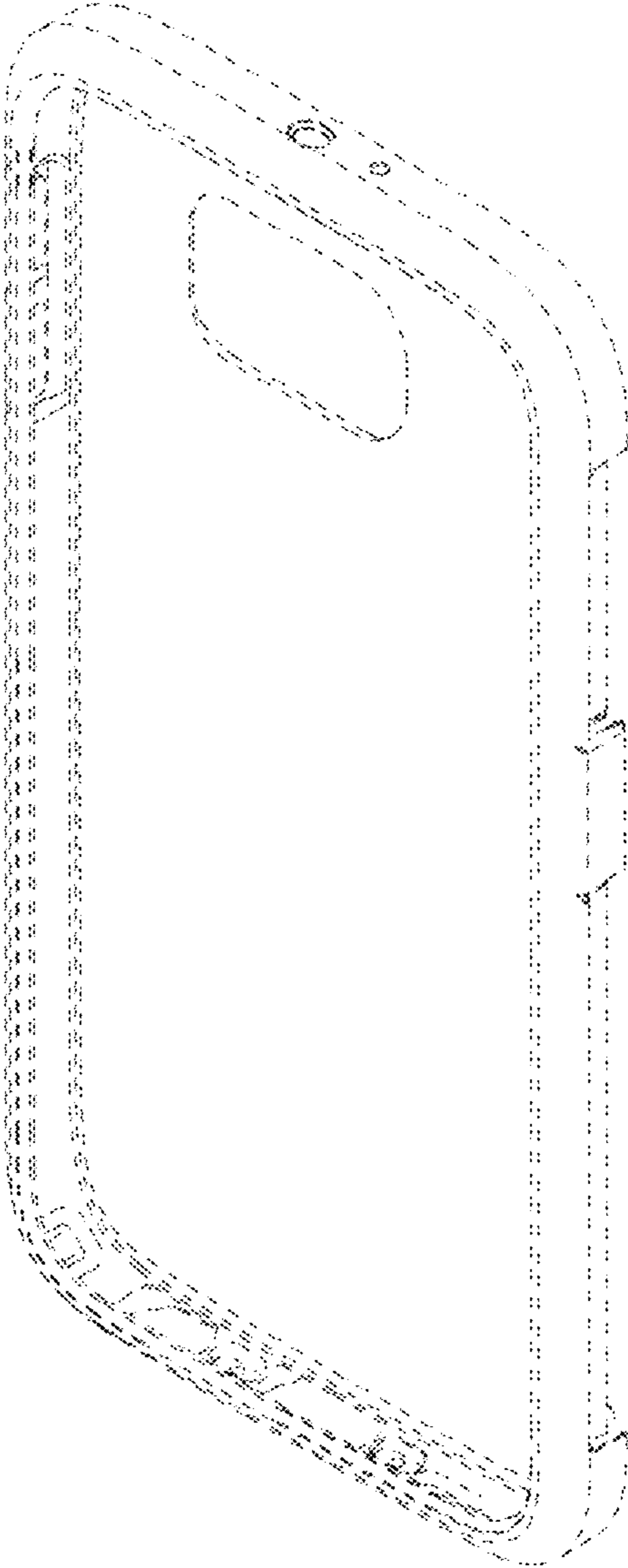

FIG. 12

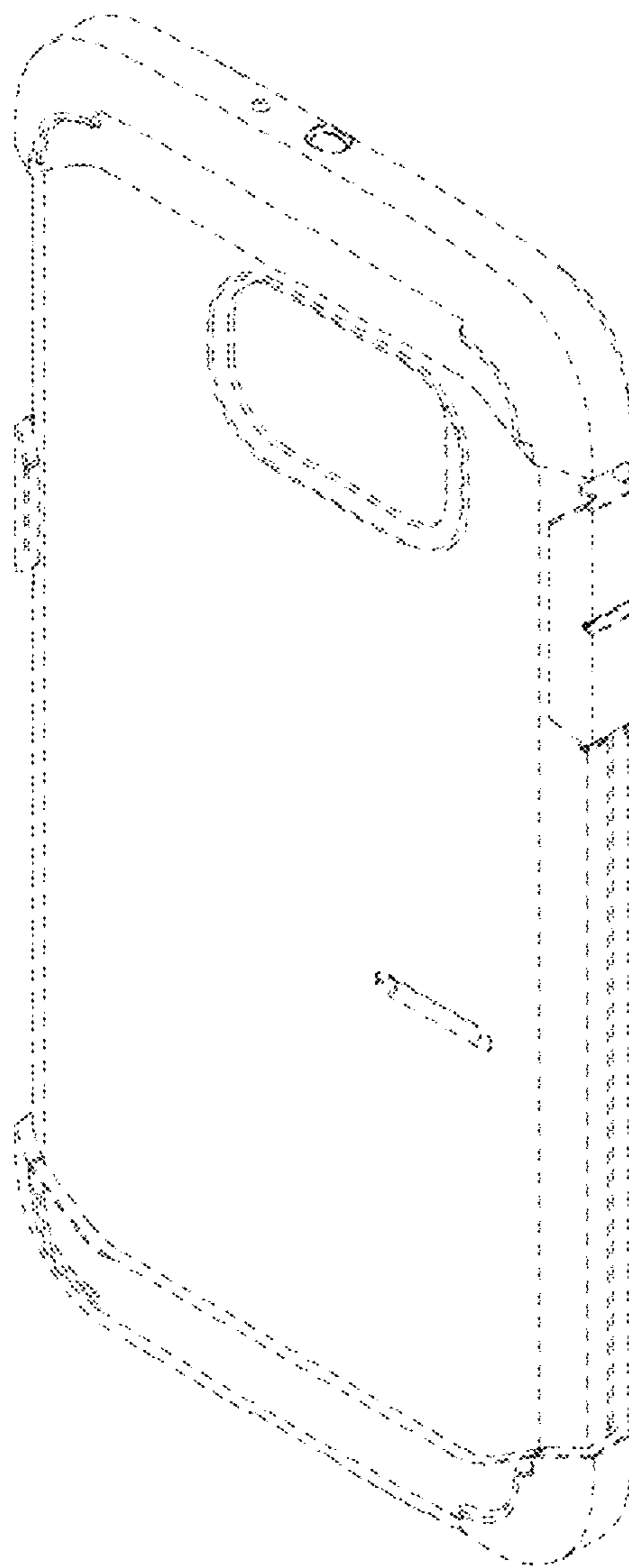

FIG. 13



FIG. 14

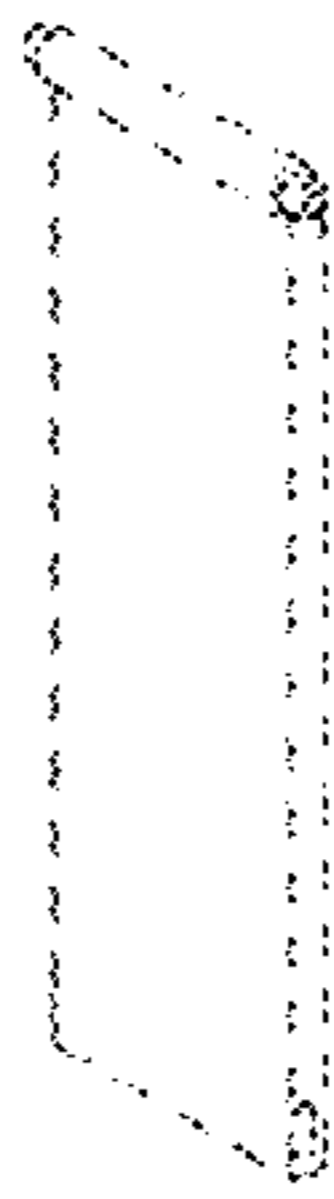



FIG. 15

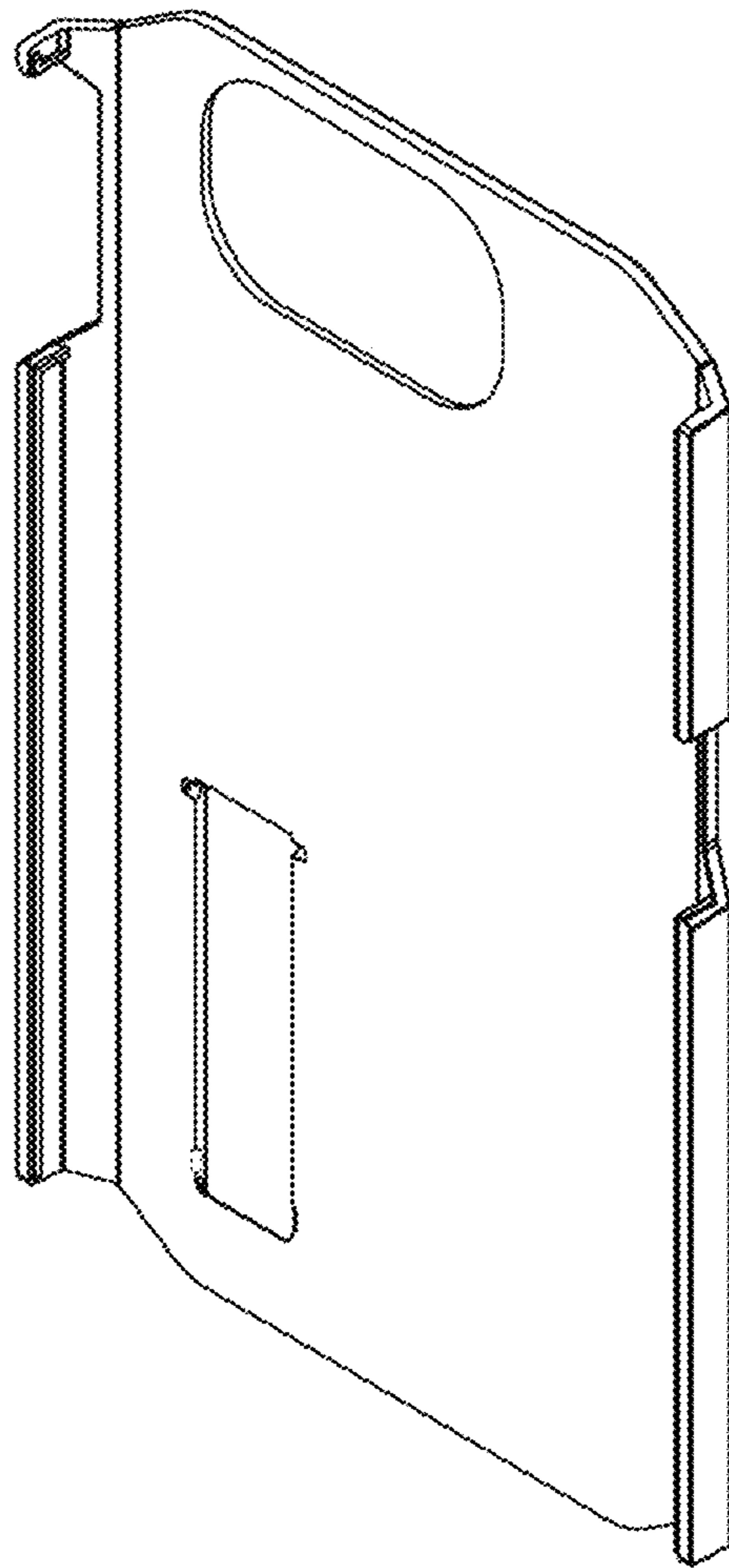

FIG. 16

