



US00D797070S

(12) **United States Design Patent** (10) **Patent No.:** **US D797,070 S**
Lee et al. (45) **Date of Patent:** **** Sep. 12, 2017**

(54) **MOBILE PHONE**

- (71) Applicant: **LG ELECTRONICS INC.**, Seoul (KR)
- (72) Inventors: **Eunsang Lee**, Seoul (KR); **Seongchan Byun**, Seoul (KR); **Sanghyun Eim**, Seoul (KR)
- (73) Assignee: **LG ELECTRONICS INC.**, Seoul (KR)
- (**) Term: **15 Years**
- (21) Appl. No.: **29/538,424**
- (22) Filed: **Sep. 3, 2015**
- (30) **Foreign Application Priority Data**

Mar. 9, 2015 (KR) 30-2015-0011804

(51) **LOC (10) Cl.** **14-03**

(52) **U.S. Cl.**
USPC **D14/138 AB**

(58) **Field of Classification Search**
 USPC D14/341-347, 137, 138 R, 138 AA, D14/138 AB, 138 C, 138 G, 496, 203.1, D14/203.3, 203.4, 203.7, 129, 130, 147, D14/218, 247, 248, 250, 385, 388, 389, D14/315-318, 420, 426, 439; D21/329, D21/330; D10/50, 65, 104.1
 CPC . A63H 33/3016; G06F 1/1613; G06F 1/1647; G06F 1/1641; G06F 3/04883; G06F 3/0486; G06F 3/04847; G06F 3/04845; G06F 3/0484; H04M 1/0279; H04M 1/0281; H04M 1/0283
 See application file for complete search history.

(56) **References Cited**

U.S. PATENT DOCUMENTS

- D534,014 S * 12/2006 Mendini D6/682.4
- D570,372 S * 6/2008 Andre D14/496
- D706,773 S * 6/2014 Lu D14/341
- 9,007,226 B2 * 4/2015 Chang G09G 3/006 340/540

(Continued)

OTHER PUBLICATIONS

LG G4's new Quick Circle Case, announced Aug. 28, 2015 [online], [site visited Apr. 26, 2017]. Available from Internet, URL: <http://www.androidcentral.com/quick-hands-lg-g4s-new-quick-circle-case>.*

Primary Examiner — Barbara Fox

Assistant Examiner — Dana K Weiland

(74) *Attorney, Agent, or Firm* — Birch, Stewart, Kolasch & Birch, LLP

(57) **CLAIM**

The ornamental design for a mobile phone, as shown and described.

DESCRIPTION

FIG. 1 is a perspective view of a mobile phone showing our new design;
 FIG. 2 is a front view thereof;
 FIG. 3 is a rear view thereof;
 FIG. 4 is a left side view thereof where the right side view is a mirror image;
 FIG. 5 is a top plan view thereof where the bottom plan view is a mirror image;
 FIG. 6 is a rear perspective view thereof;
 FIG. 7 is a rear perspective view in a condition that the mobile phone is folded in half;
 FIG. 8 is a front view of FIG. 7;
 FIG. 9 is a rear view of FIG. 7;
 FIG. 10 is a left side view of FIG. 7 where the right side view is a mirror image;
 FIG. 11 is a top plan view of FIG. 7; and,
 FIG. 12 is a bottom plan view of FIG. 7.
 The broken lines depict portions of the mobile phone that form no part of the claimed design.

1 Claim, 12 Drawing Sheets

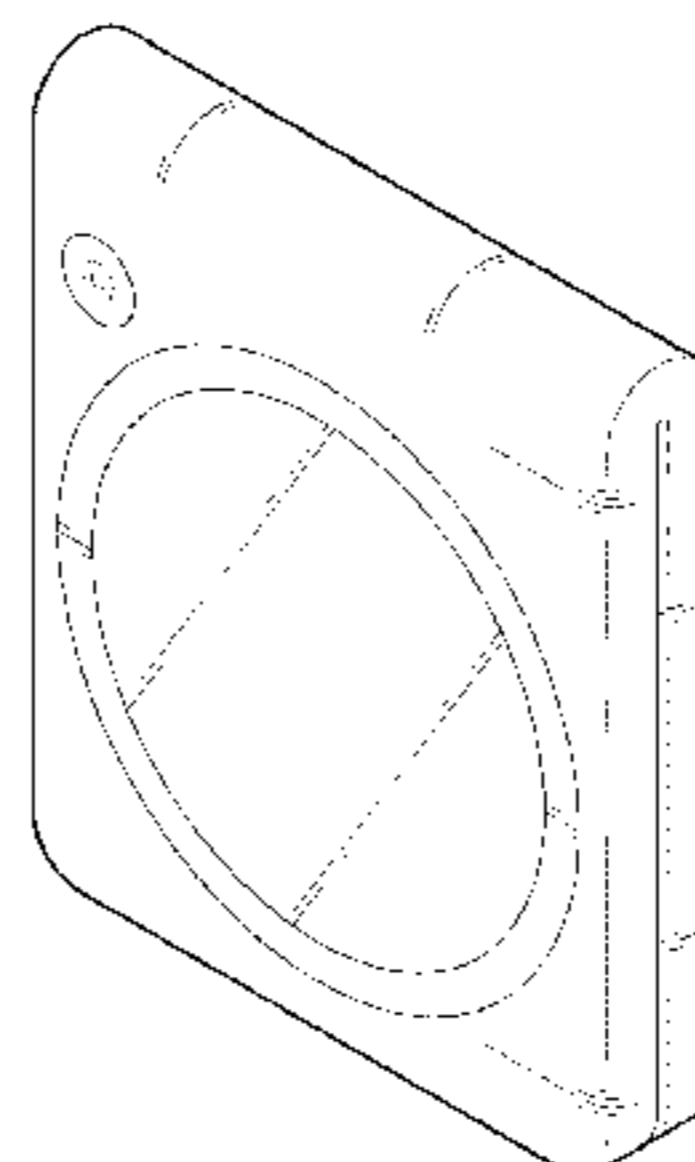
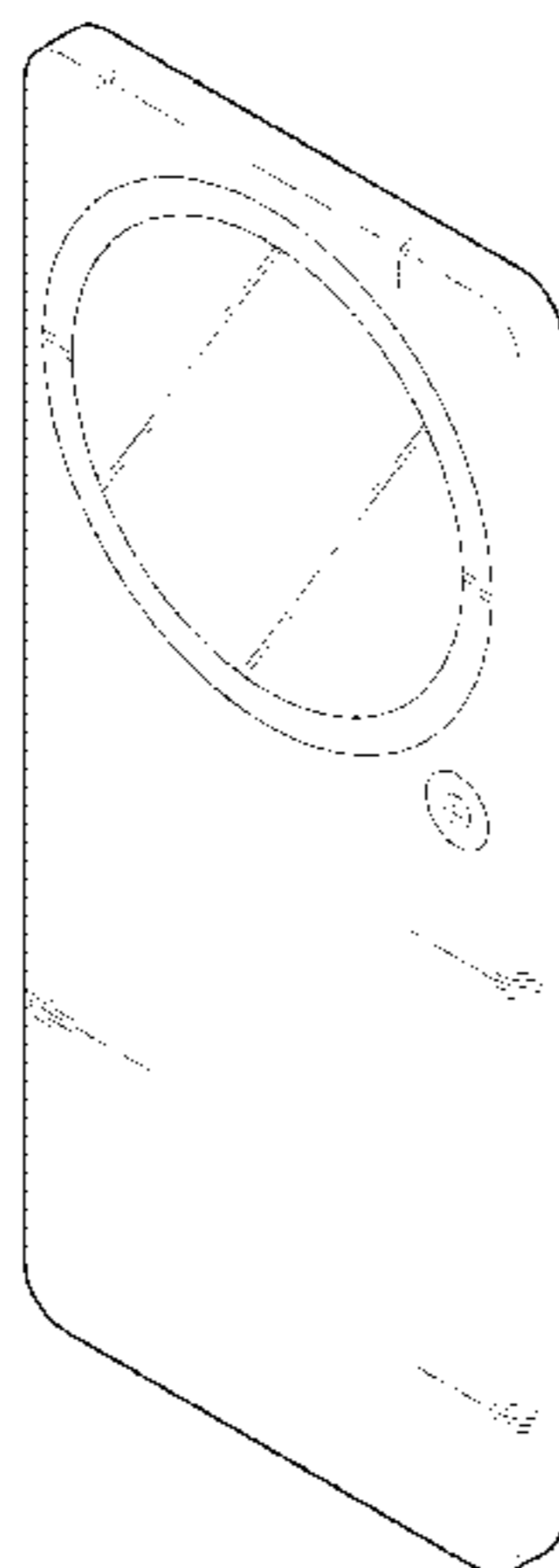

(56)

References Cited

U.S. PATENT DOCUMENTS

9,013,458	B2 *	4/2015	Cho	G06F 1/1601				
						345/204			
9,064,431	B2 *	6/2015	Ahn	G09F 9/33				
9,069,521	B2 *	6/2015	Lee	G06F 1/16				
D733,673	S *	7/2015	Zhu	D14/137				
D739,403	S *	9/2015	David	D14/341				
D748,625	S *	2/2016	Takahashi	D14/345				
9,317,067	B2 *	4/2016	Choi	G06F 1/1641				
9,342,106	B2 *	5/2016	Nurmi	G06F 1/1652				
9,349,342	B2 *	5/2016	Zhang	G09G 5/00				
D764,430	S *	8/2016	Sovertkov	D14/138 G				
D767,526	S *	9/2016	Lee	D14/138 AB				
D769,209	S *	10/2016	Byun	D14/138 AB				
D772,225	S *	11/2016	Kim	D14/341				
D774,025	S *	12/2016	Reivo	D14/248				
D775,595	S *	1/2017	Nuk	D14/126				
D775,598	S *	1/2017	Kim	D14/138 AB				
D778,864	S *	2/2017	Kim	D14/138 AB				
D781,832	S *	3/2017	Snitko	D14/250				
D783,568	S *	4/2017	Pista	D14/144				
2009/0009945	A1 *	1/2009	Johnson	G06F 1/1613				
						361/679.27			
2012/0262367	A1 *	10/2012	Chiu	G06F 1/1626				
						345/156			
2013/0216740	A1 *	8/2013	Russell-Clarke	B23K 26/38				
						428/33			
2014/0198036	A1 *	7/2014	Kim	G06F 1/1652				
						345/156			
2014/0226275	A1 *	8/2014	Ko	G06F 1/1626				
						361/679.27			
2014/0293024	A1 *	10/2014	Choi	G06F 1/1601				
						348/54			
2014/0353613	A1 *	12/2014	Cheon	H01L 51/0097				
						257/40			
2015/0049428	A1 *	2/2015	Lee	G06F 1/1641				
						361/679.27			
2015/0146349	A1 *	5/2015	Choi	G06F 1/1677				
						361/679.01			
2015/0155903	A1 *	6/2015	Jang	H04B 1/3888				
						455/575.8			
2015/0338888	A1 *	11/2015	Kim	G06F 1/1677				
						345/156			
2016/0132074	A1 *	5/2016	Kim	G06F 1/1652				
						715/769			
2016/0179236	A1 *	6/2016	Shin	G06F 1/1616				
						345/173			
2016/0337583	A1 *	11/2016	Kang	H04N 5/2254				
2017/0003756	A1 *	1/2017	Gao	G06F 1/1641				
2017/0069299	A1 *	3/2017	Kwak	G06F 3/147				
2017/0094168	A1 *	3/2017	Kang	H04N 5/23238				

* cited by examiner

FIG. 1

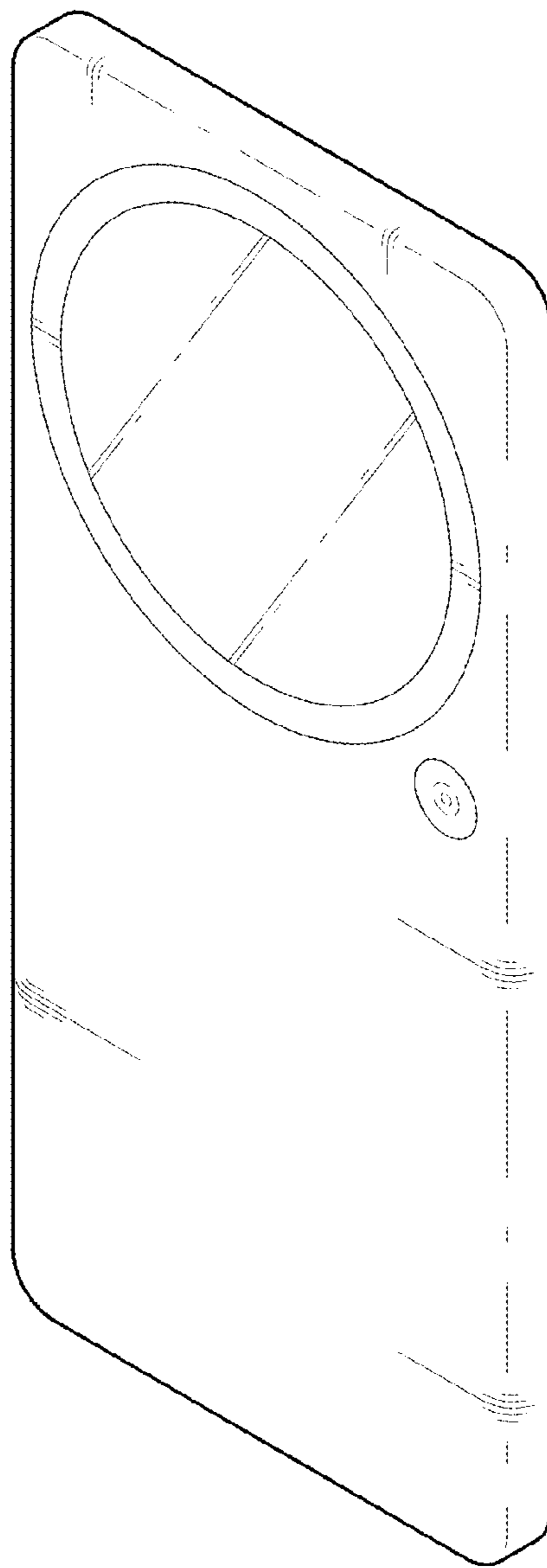

FIG. 2

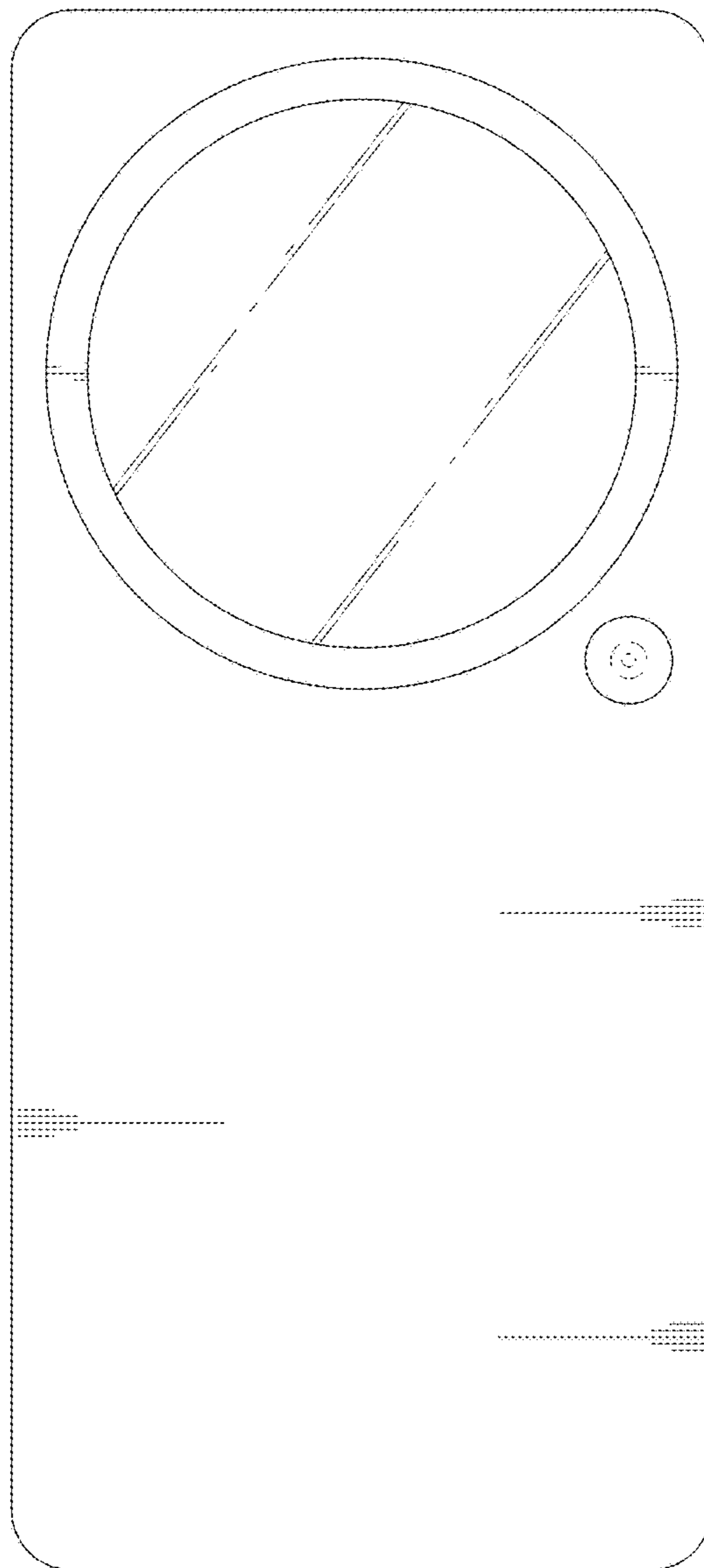

FIG. 3

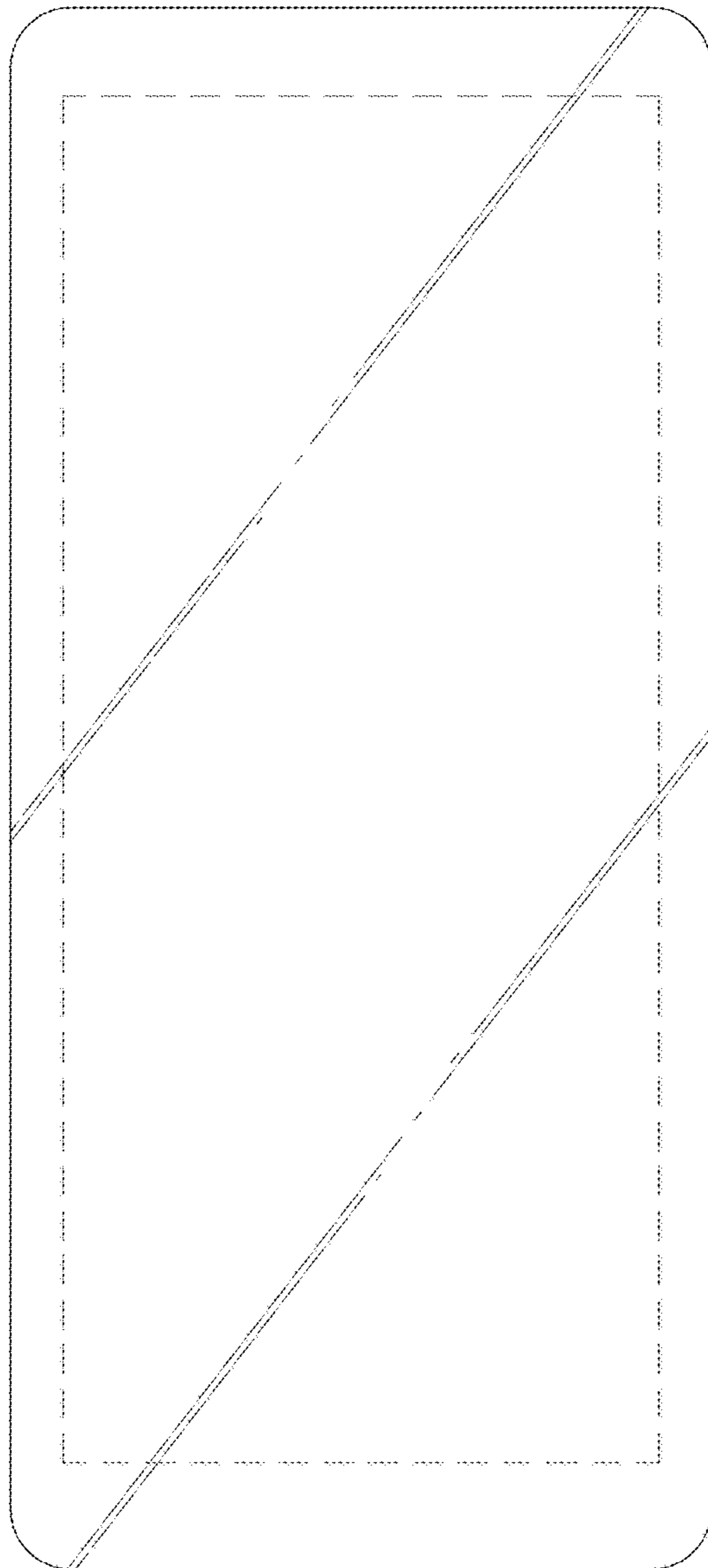

FIG. 4



FIG. 5



FIG. 6

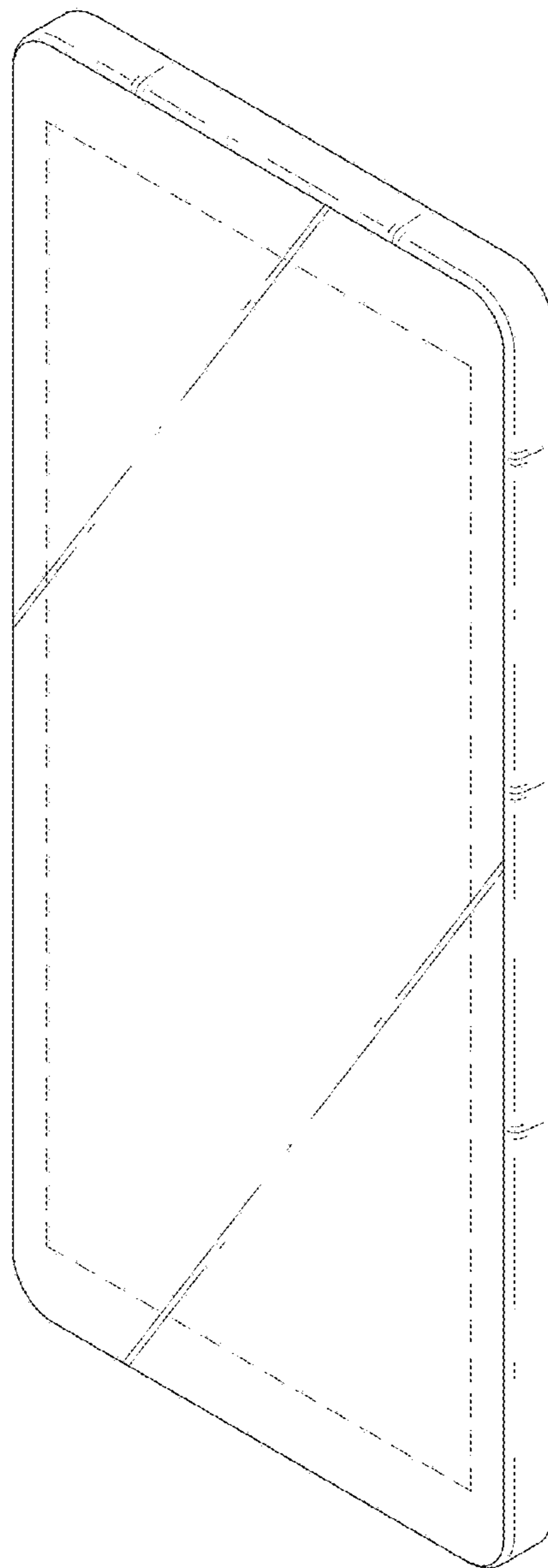

FIG. 7

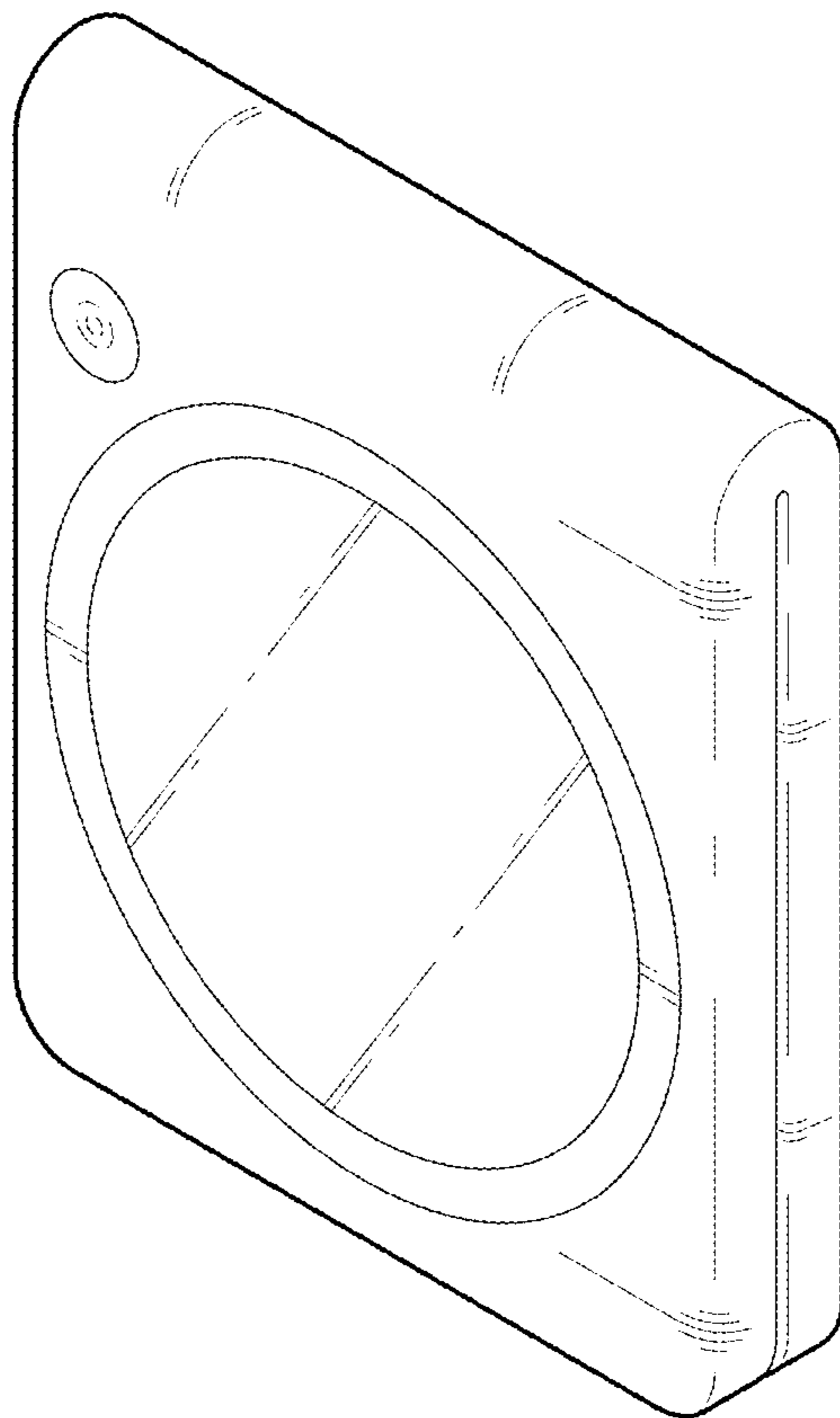

FIG. 8

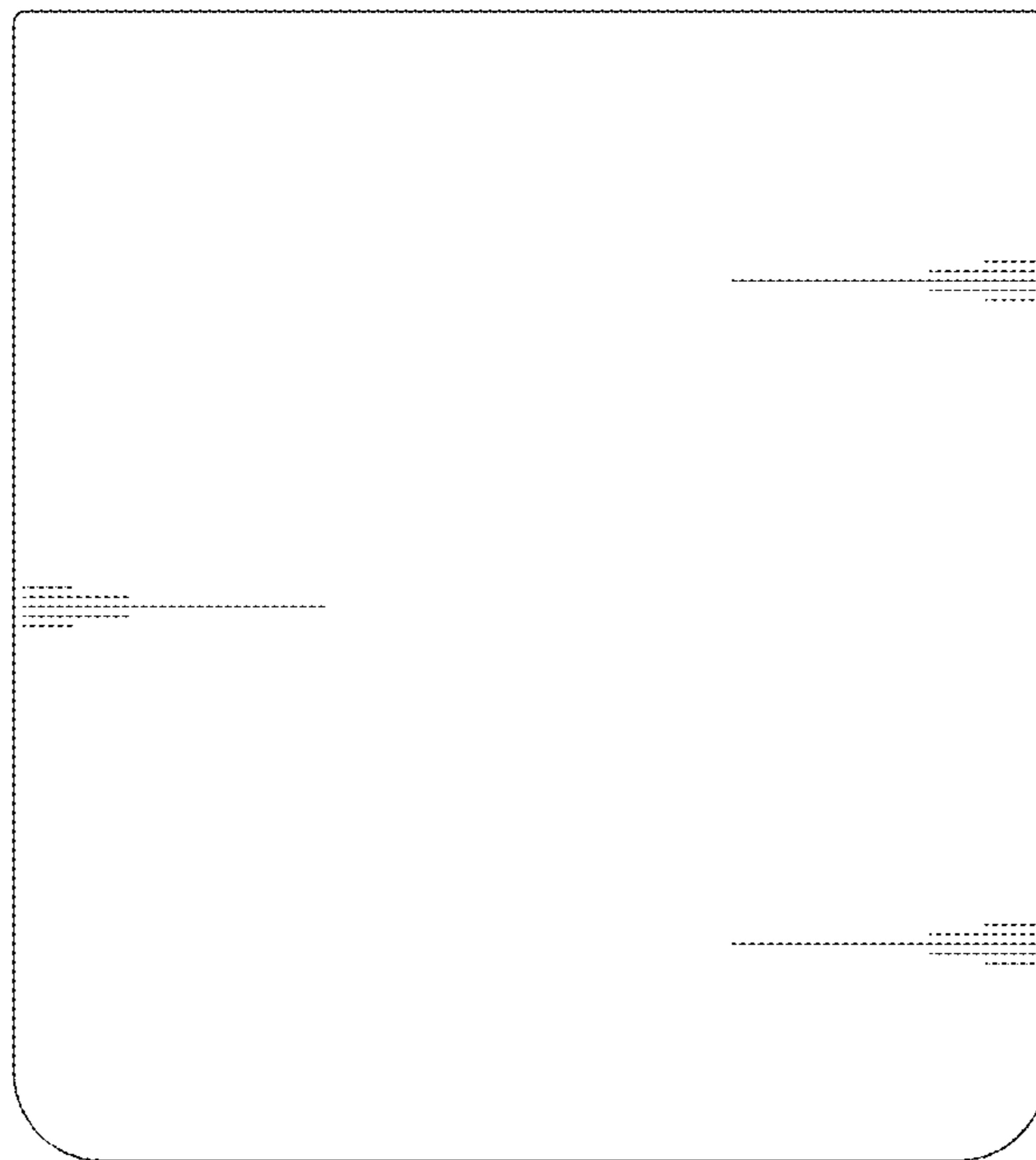

FIG. 9

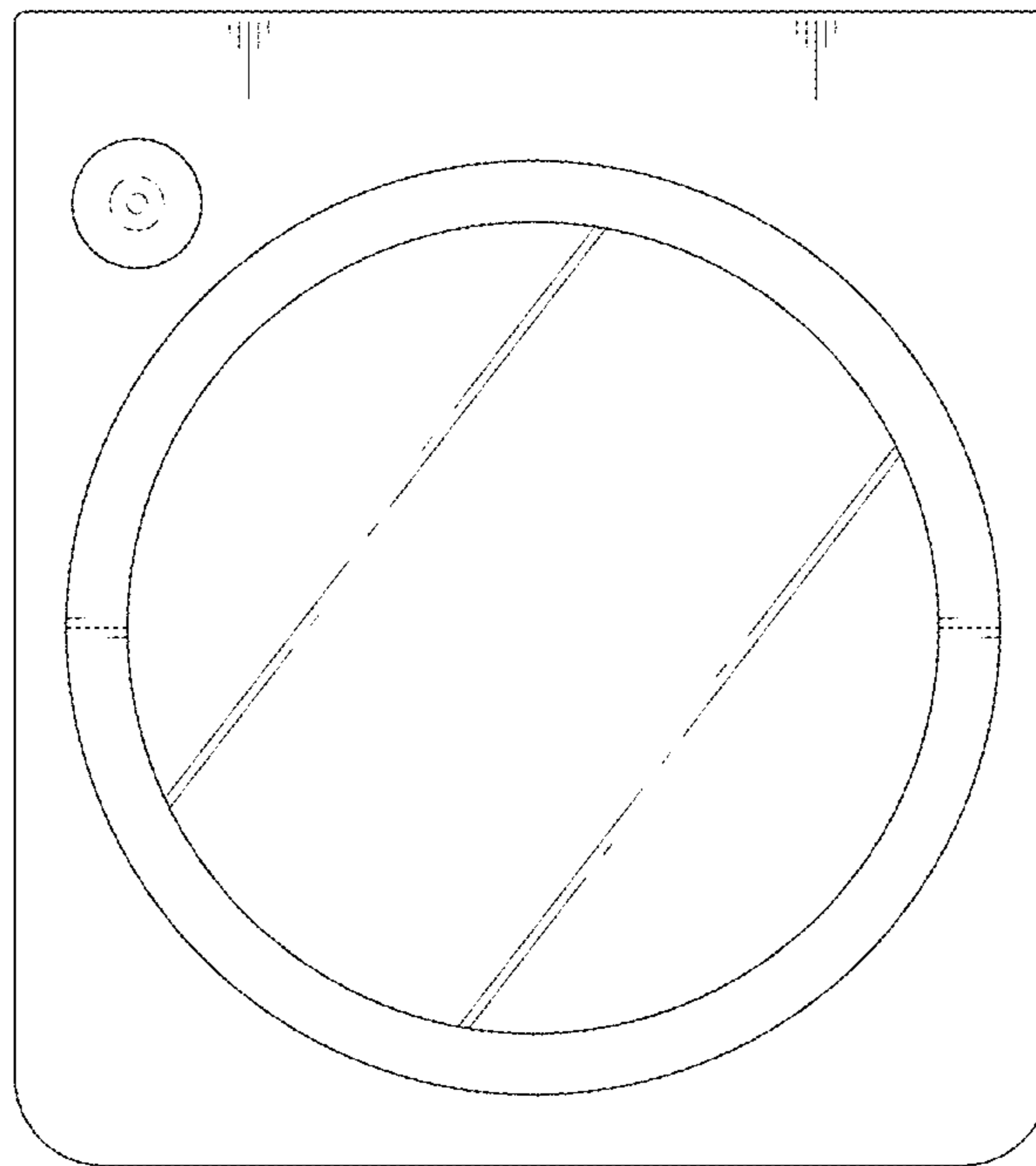

FIG. 10

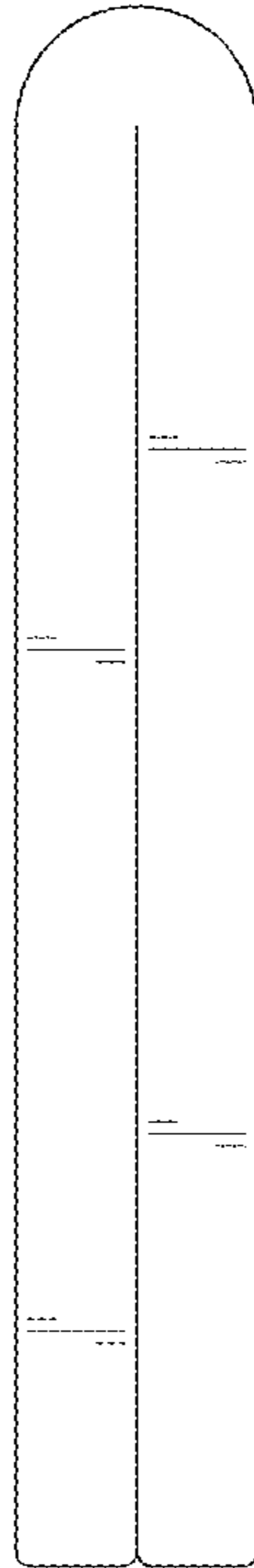

FIG. 11



FIG. 12

