



US00D797050S

(12) **United States Design Patent** (10) **Patent No.:** **US D797,050 S**  
**Wadhvani** (45) **Date of Patent:** **\*\* Sep. 12, 2017**

(54) **SOCKET**  
(71) Applicant: **Dinesh Wadhvani**, Natick, MA (US)  
(72) Inventor: **Dinesh Wadhvani**, Natick, MA (US)  
(\*\*) Term: **15 Years**  
(21) Appl. No.: **29/555,301**  
(22) Filed: **Feb. 19, 2016**  
(51) **LOC (10) Cl.** ..... **13-03**  
(52) **U.S. Cl.**  
USPC ..... **D13/134**  
(58) **Field of Classification Search**  
USPC ..... D13/101, 103, 110, 118, 123, 133-136,  
D13/146, 147, 149, 151-156, 173, 182,  
D13/184, 199; D26/1-3, 27, 113, 142  
CPC ..... A61L 9/20; B01J 19/12; F21S 8/00; F21V  
19/00; H01H 85/00; H01J 5/48; H01J  
5/50; H01J 5/54; H01J 19/48; H01R 4/24;  
H01R 13/00; H01R 13/66; H01R 24/00;  
H01R 33/00; H01R 33/05; H01R 33/08  
See application file for complete search history.

2005/0202704 A1\* 9/2005 Lingemann ..... H01R 33/0854  
439/236  
2009/0068869 A1\* 3/2009 Brand ..... H01R 33/0854  
439/226  
2010/0081339 A1\* 4/2010 Galluccio ..... H01R 33/08  
439/699.2  
2013/0181594 A1\* 7/2013 Osada ..... H01R 33/0845  
313/51  
2014/0206217 A1\* 7/2014 Osada ..... H01R 33/0854  
439/240

(56) **References Cited**  
U.S. PATENT DOCUMENTS  
2,317,163 A \* 4/1943 Young ..... H01R 33/0836  
362/217.08  
2,401,610 A \* 6/1946 Burns ..... H01R 33/0836  
439/241  
2,569,662 A \* 10/1951 Fallek ..... F21V 19/008  
362/217.09  
D388,395 S \* 12/1997 Henrici ..... D13/134  
6,290,522 B1 \* 9/2001 Campolo ..... H01R 33/0854  
439/241  
D491,890 S \* 6/2004 Henrici ..... D13/134  
D550,884 S \* 9/2007 Tufano ..... D26/75  
D647,850 S \* 11/2011 Osada ..... D13/134  
D647,851 S \* 11/2011 Osada ..... D13/134  
8,858,019 B2 \* 10/2014 Novak ..... F21S 8/036  
362/221

**OTHER PUBLICATIONS**

Leviton 13661-SWP, dated Feb. 26, 2009, [online], [site visited Jul. 20, 2016]. Available from Internet, <URL: <https://www.amazon.com/Leviton-13661-SWP-Fluorescent-Lampholder-660W-600V/dp/B003AUNYPK>>.\*

\* cited by examiner

*Primary Examiner* — Thomas Johannes  
*Assistant Examiner* — Shawn T Gingrich  
(74) *Attorney, Agent, or Firm* — Gary E. Lambert; David J. Connaughton, Jr.; Lambert & Associates

(57) **CLAIM**

The ornamental design for a socket, as shown and described.

**DESCRIPTION**

FIG. 1 is a front perspective view of the socket, which embodies my design;  
FIG. 2 is a back side view of the socket;  
FIG. 3 is a front view of the socket;  
FIG. 4 is a side view of the socket;  
FIG. 5 is side view of the socket;  
FIG. 6 is a top plane view of the socket; and,  
FIG. 7 is a bottom plane view of the socket.  
The broken line portion of the figure drawings is included to show portions of the article that form no part of the claimed design.

**1 Claim, 4 Drawing Sheets**

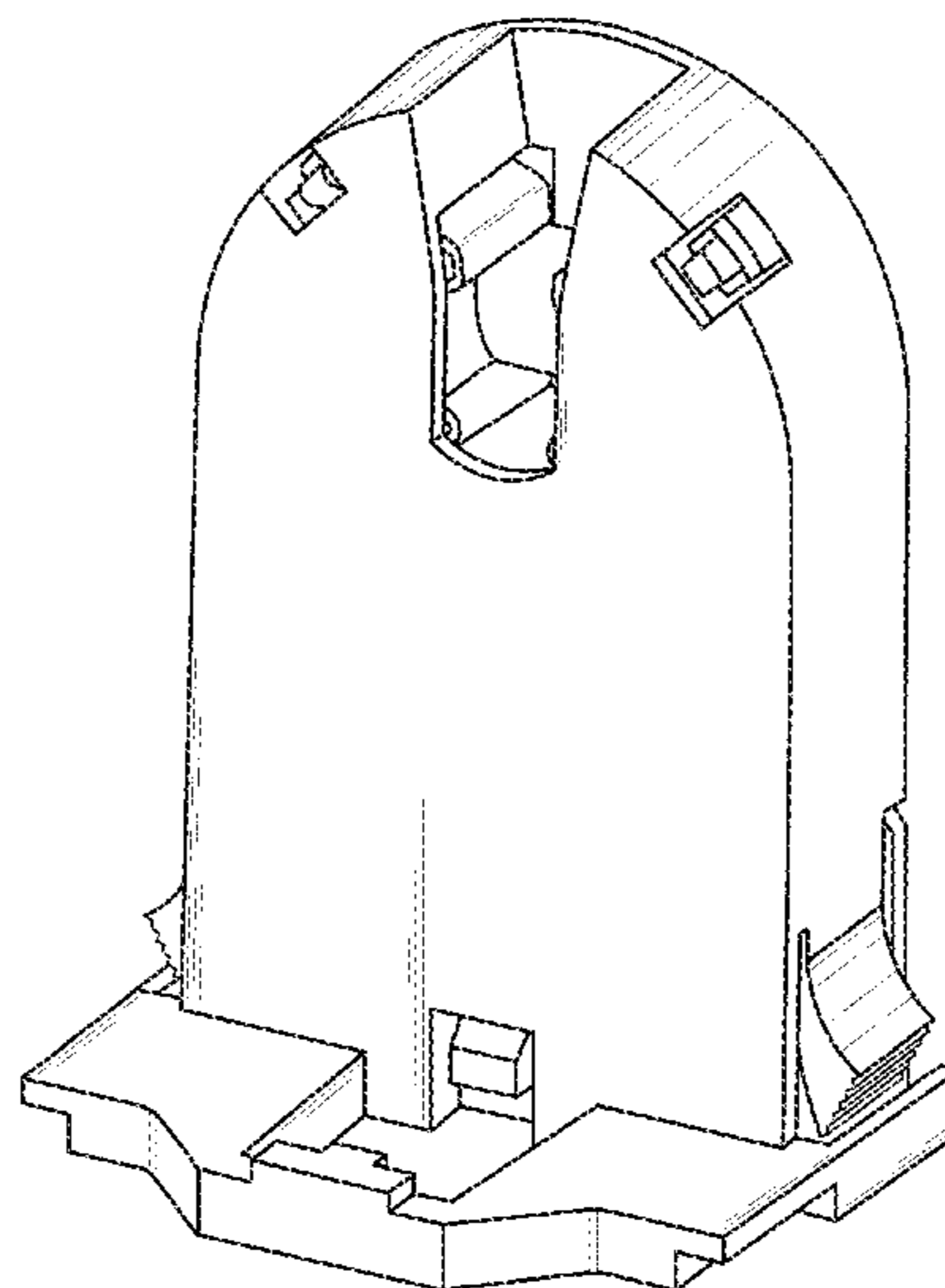

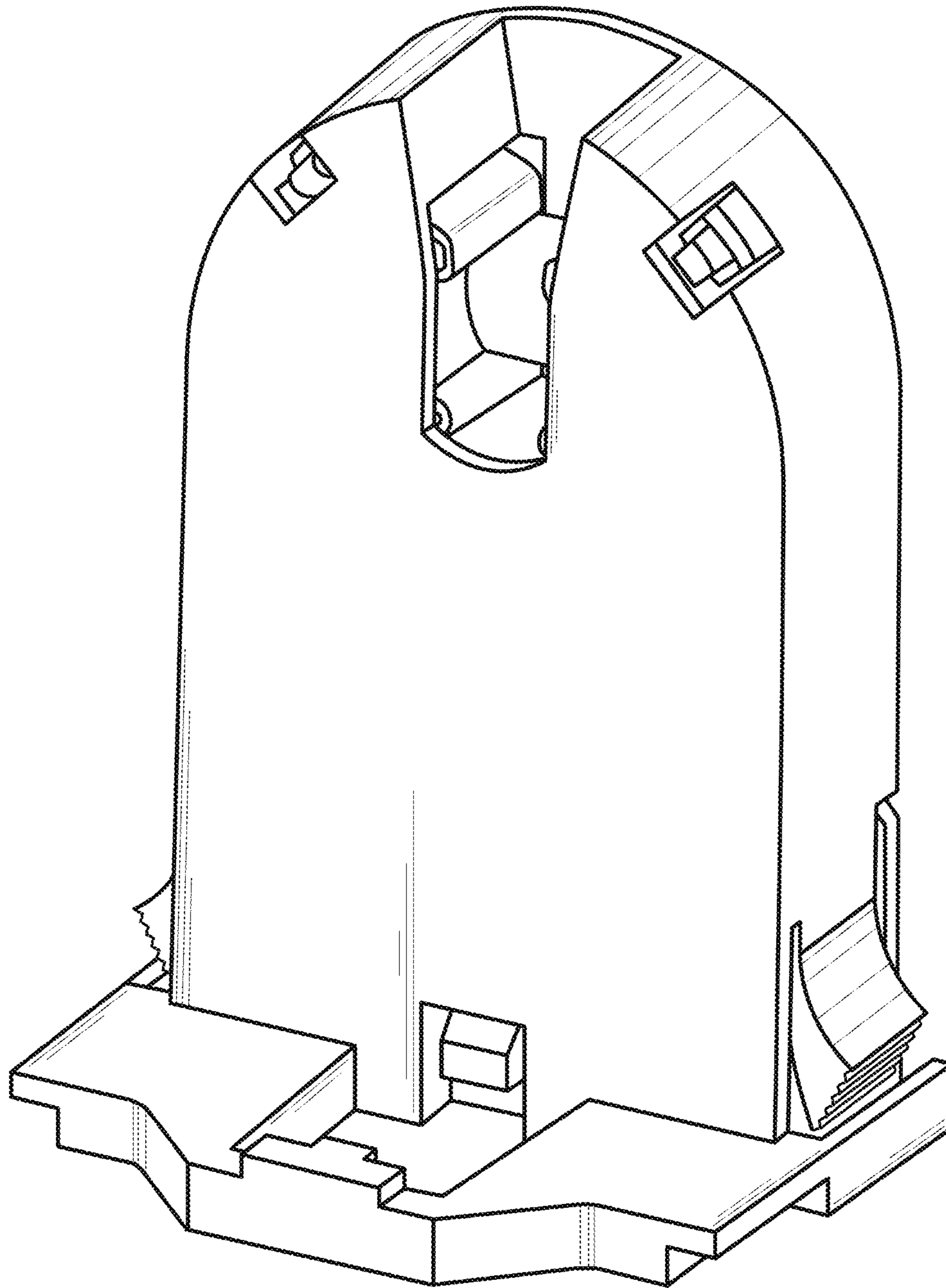

*Fig. 1*

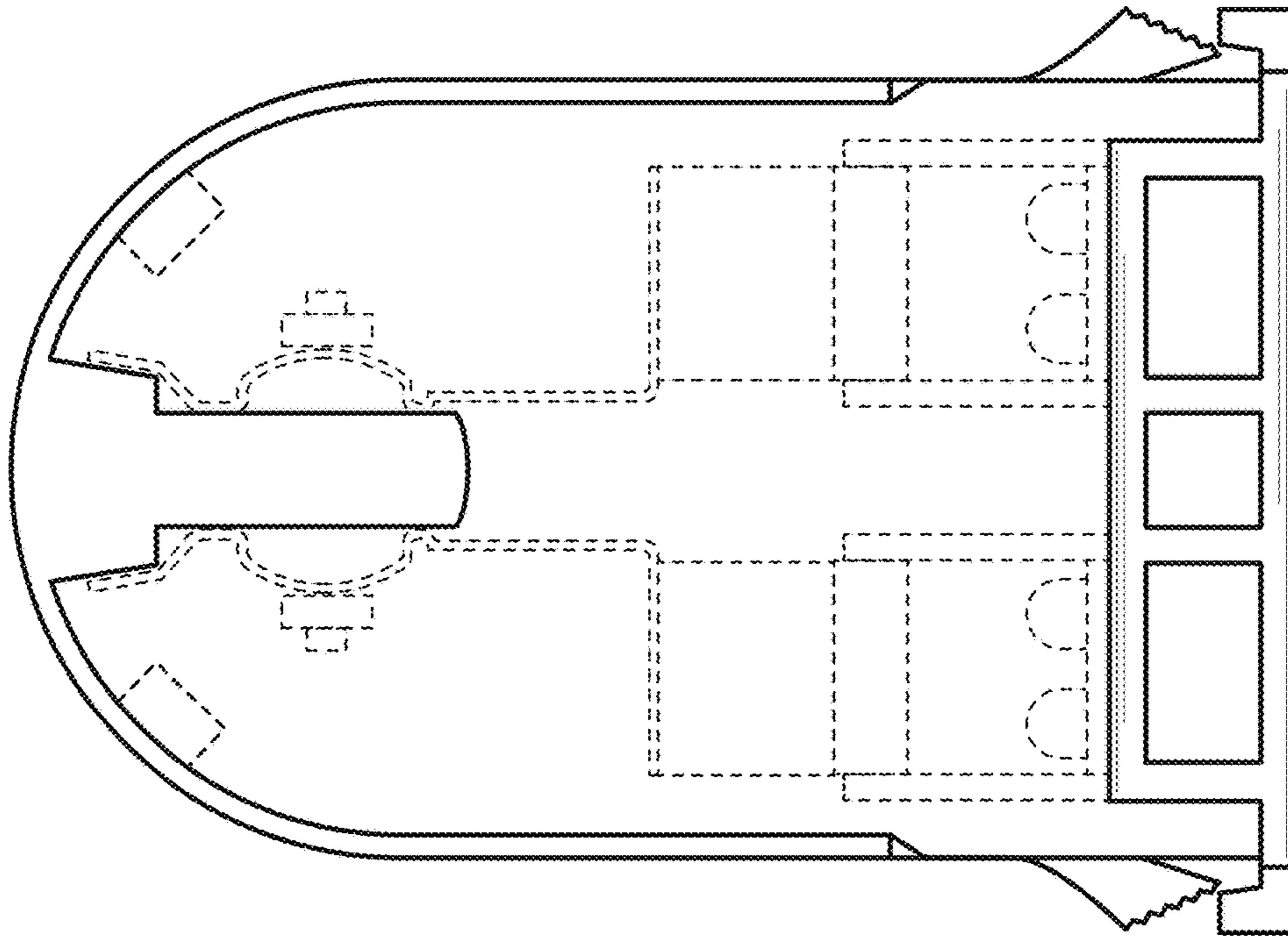

Fig. 3

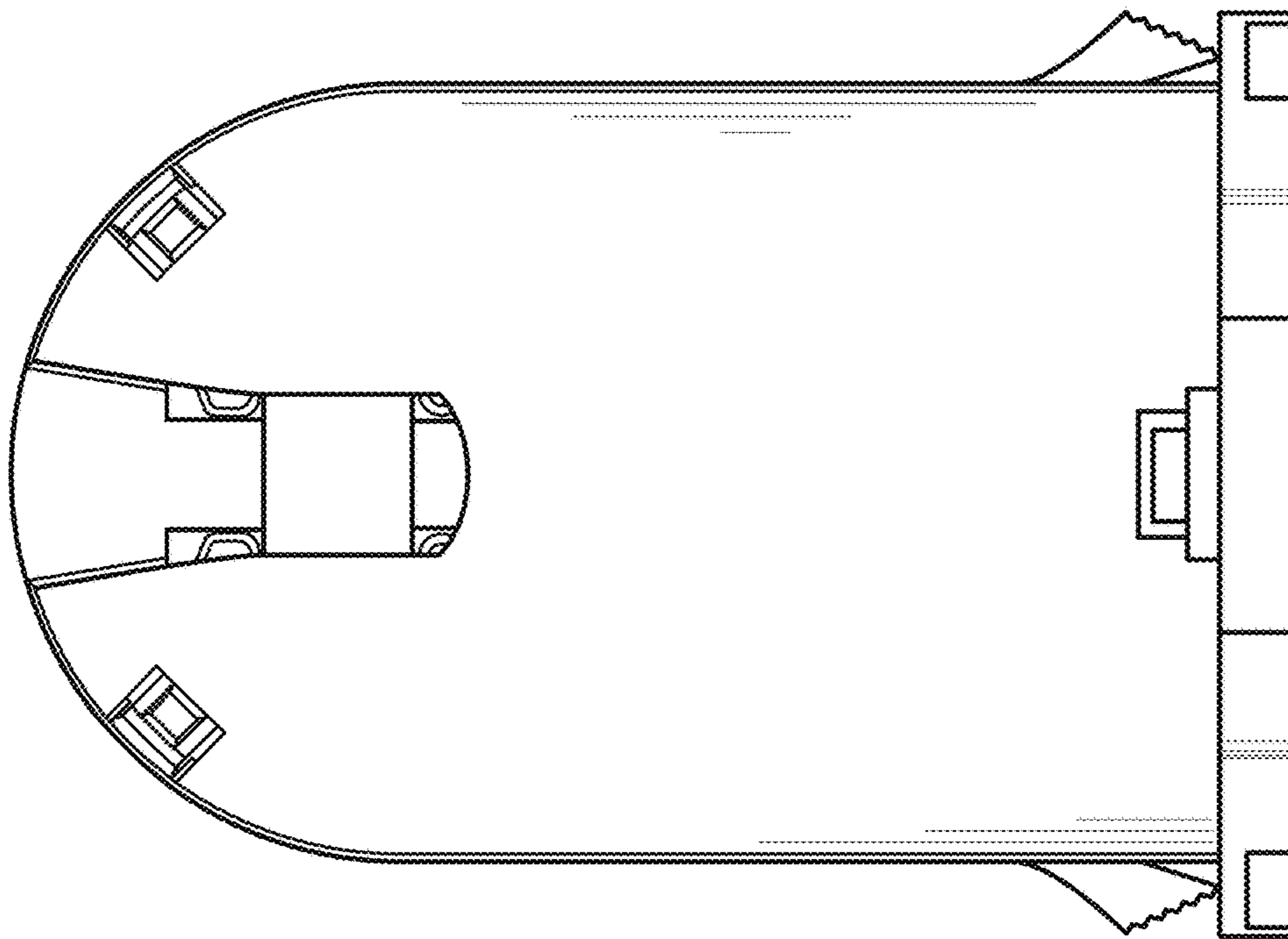
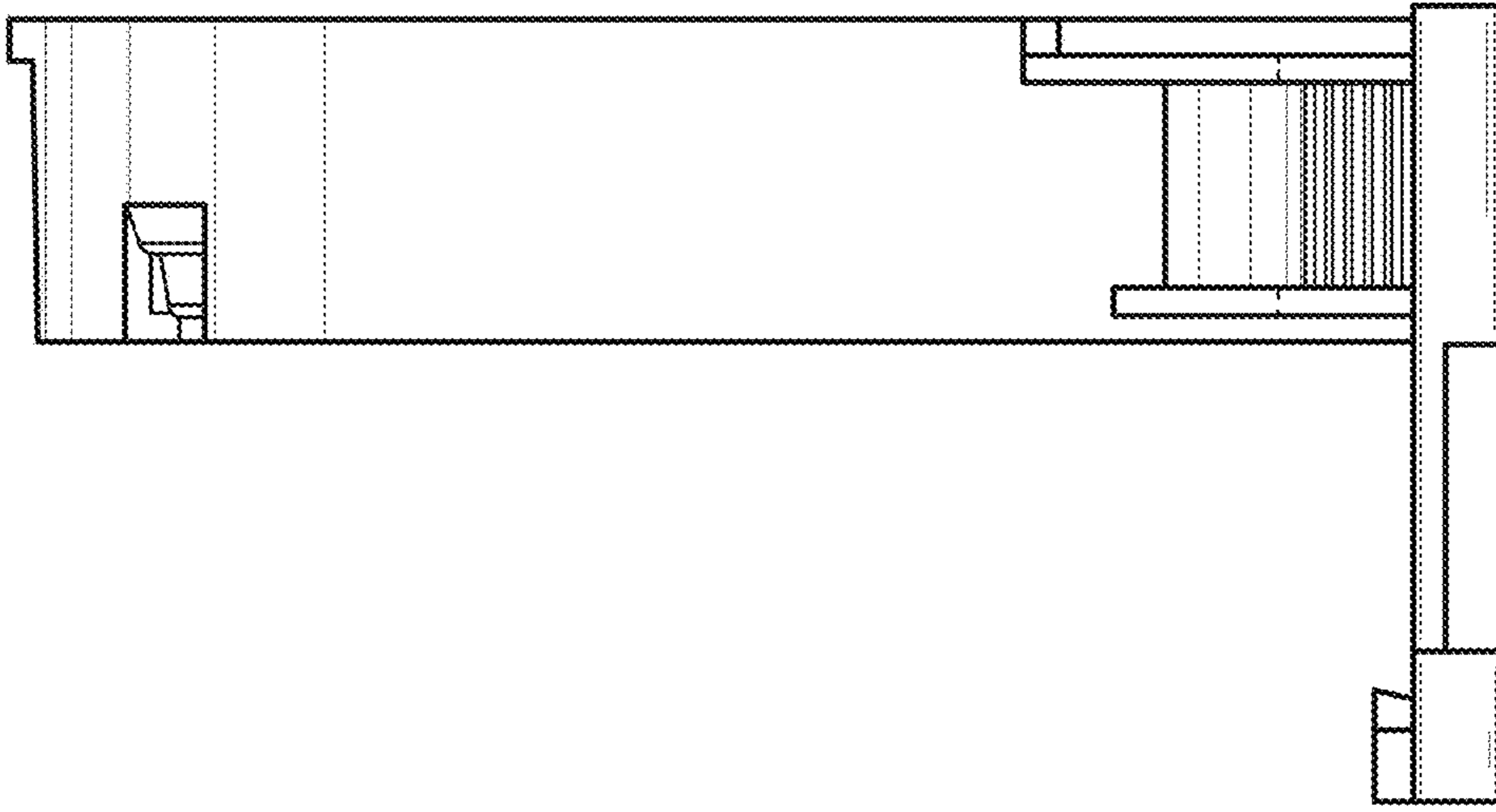
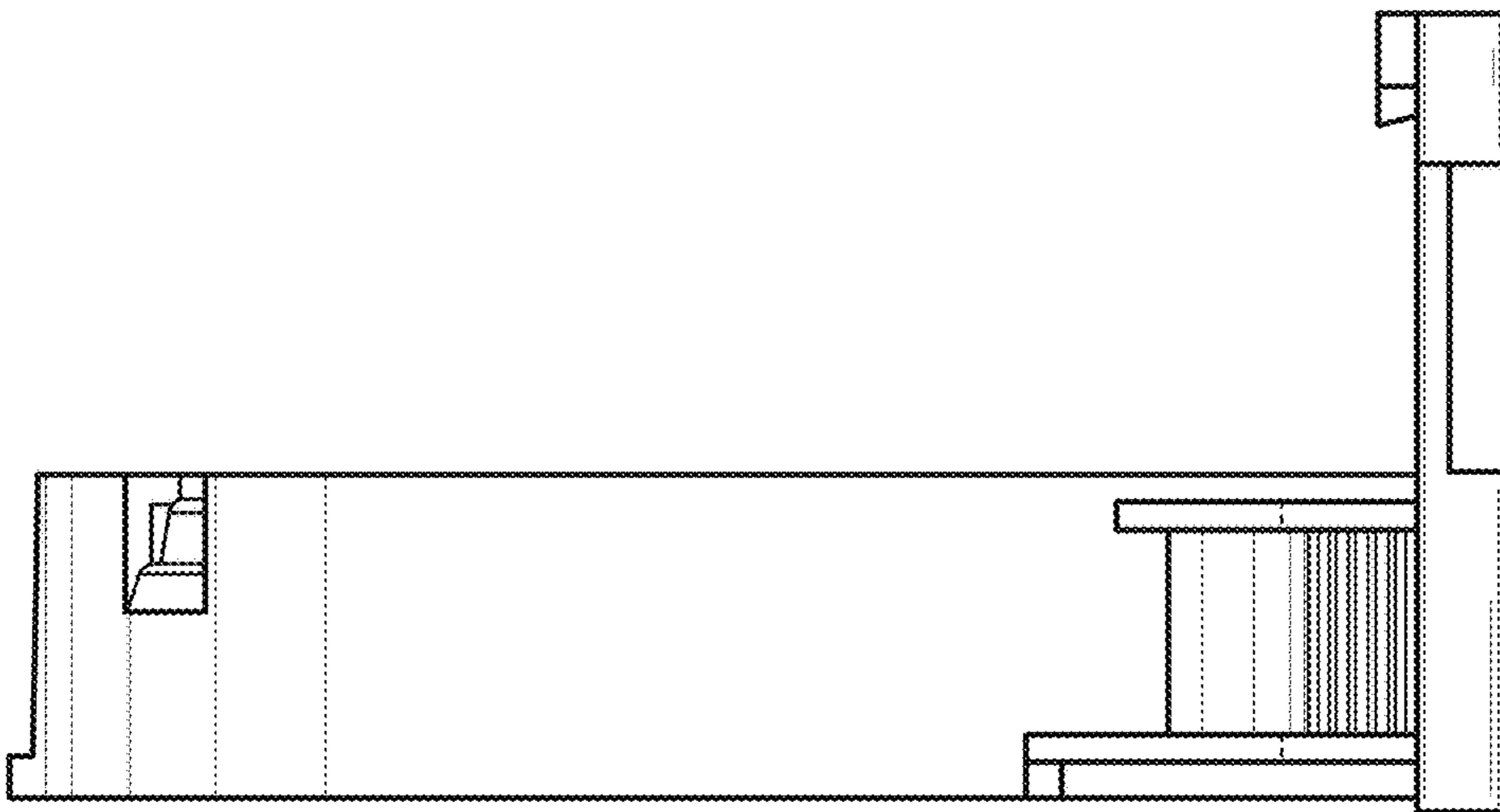

Fig. 2



*Fig. 5*



*Fig. 4*

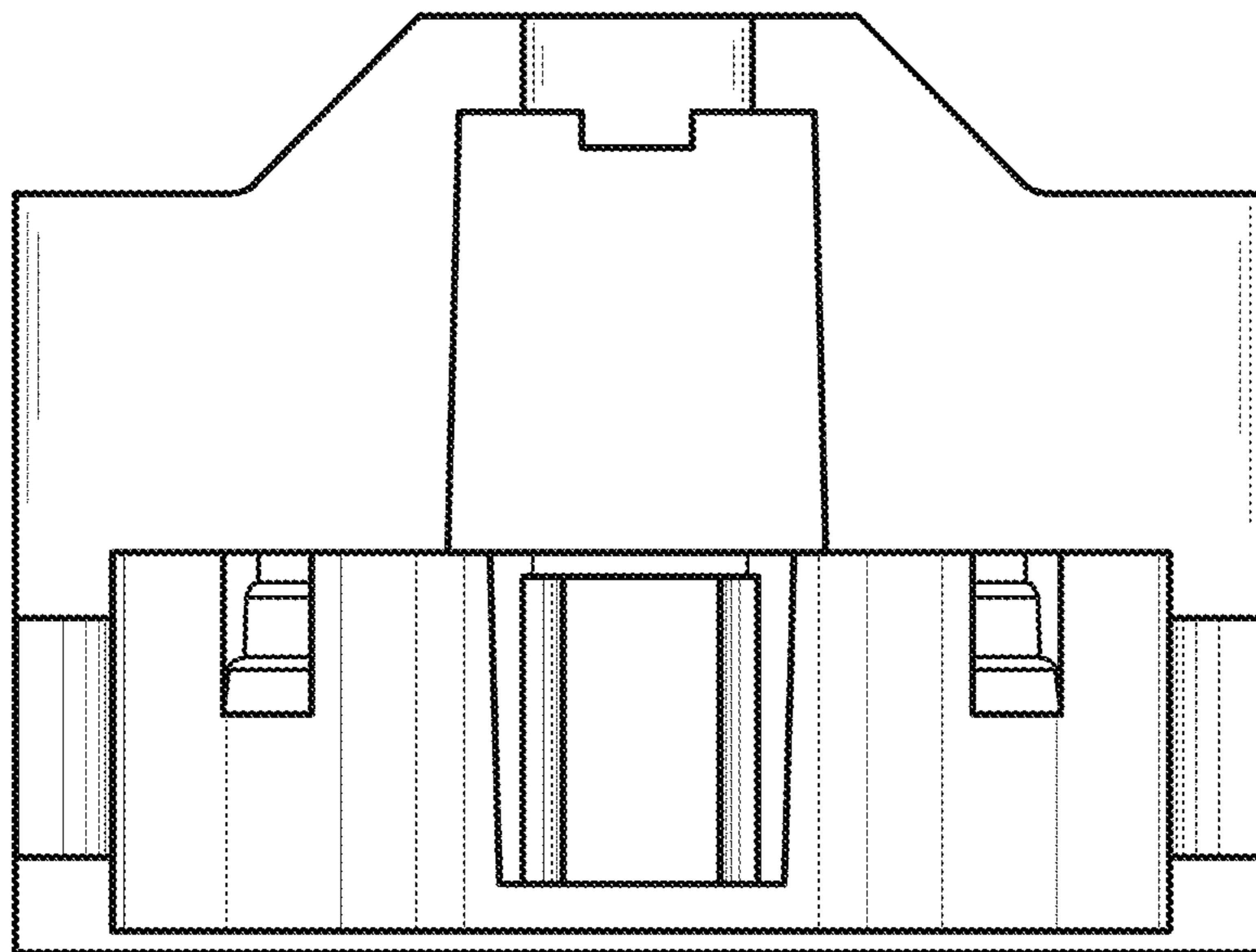

*Fig. 6*

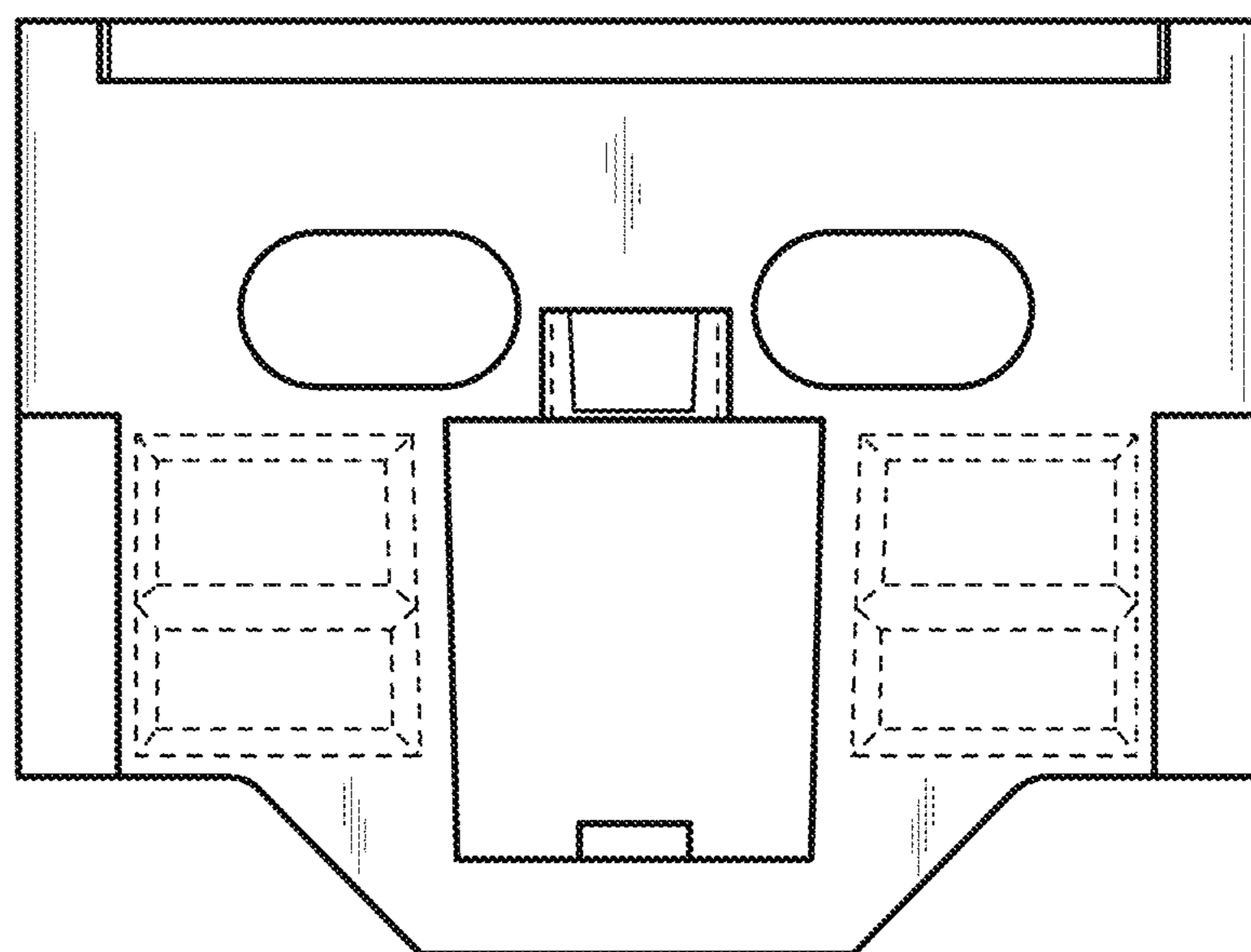

*Fig. 7*