



US00D797000S

(12) **United States Design Patent** (10) **Patent No.:** **US D797,000 S**  
**Kumono et al.** (45) **Date of Patent:** **\*\* Sep. 12, 2017**

(54) **AUTOMOBILE**

(71) Applicants: **Yuuki Kumono**, Gunma-ken (JP);  
**Kenji Kamahara**, Oota (JP)

(72) Inventors: **Yuuki Kumono**, Gunma-ken (JP);  
**Kenji Kamahara**, Oota (JP)

(73) Assignees: **Toyota Jidosha Kabushiki Kaisha**  
(JP); **Fuji Jukogyo Kabushiki Kaisha**  
(JP)

(\*\*) Term: **15 Years**

(21) Appl. No.: **29/565,108**

(22) Filed: **May 18, 2016**

(30) **Foreign Application Priority Data**

Dec. 17, 2015 (JP) ..... 2015-028146

(51) **LOC (10) Cl.** ..... **12-08**

(52) **U.S. Cl.**  
USPC ..... **D12/92**

(58) **Field of Classification Search**  
USPC ..... D12/86, 90-92, 88; D21/421, 433, 434;  
296/181.1, 181.5  
CPC ..... B62D 35/00; B62D 25/00; B62D 25/06;  
B62D 33/00  
See application file for complete search history.

(56) **References Cited**

**U.S. PATENT DOCUMENTS**

- D719,066 S \* 12/2014 Schramm ..... D12/92
- D751,465 S \* 3/2016 Stopka ..... D12/92
- D754,565 S \* 4/2016 Varga ..... D12/92
- D754,566 S \* 4/2016 Varga ..... D12/92
- D755,677 S \* 5/2016 Stopka ..... D12/92
- D757,609 S \* 5/2016 Stopka ..... D12/92
- D757,610 S \* 5/2016 Stopka ..... D12/92

- D762,525 S \* 8/2016 Stopka ..... D12/92
- D769,154 S \* 10/2016 Varga ..... D12/92
- D781,748 S \* 3/2017 Manzoni ..... D12/88
- D784,204 S \* 4/2017 Abdallah ..... D12/92
- D786,135 S \* 5/2017 Burki ..... D12/92

**OTHER PUBLICATIONS**

Toyota, Toyota 86 (2013), Catalogue of Toyota 86, Toyota Jidosha Kabushiki Kaisha, available at least as early as Jul. 1, 2013.  
Fuji Jukogyo Kabushiki Kaisha, Subaru BRZ (2012), Response.jp <<http://response.jp/article/2012/02/09/169774.html>>, available at least as early as Dec. 1, 2014.

\* cited by examiner

*Primary Examiner* — Melody N Brown  
(74) *Attorney, Agent, or Firm* — Saidman DesignLaw Group, LLC

(57) **CLAIM**

The ornamental design for an automobile, as shown and described.

**DESCRIPTION**

FIG. 1 is a front and right side perspective view of an automobile showing our new design;  
FIG. 2 is a rear and right side perspective view thereof;  
FIG. 3 is a front view thereof;  
FIG. 4 is a rear view thereof;  
FIG. 5 is a top view thereof;  
FIG. 6 is a left side view thereof; and,  
FIG. 7 is a right side view thereof.  
The various shades of gray as well as the shadows and reflections represent contour and not surface ornamentation or any particular color.

**1 Claim, 7 Drawing Sheets**





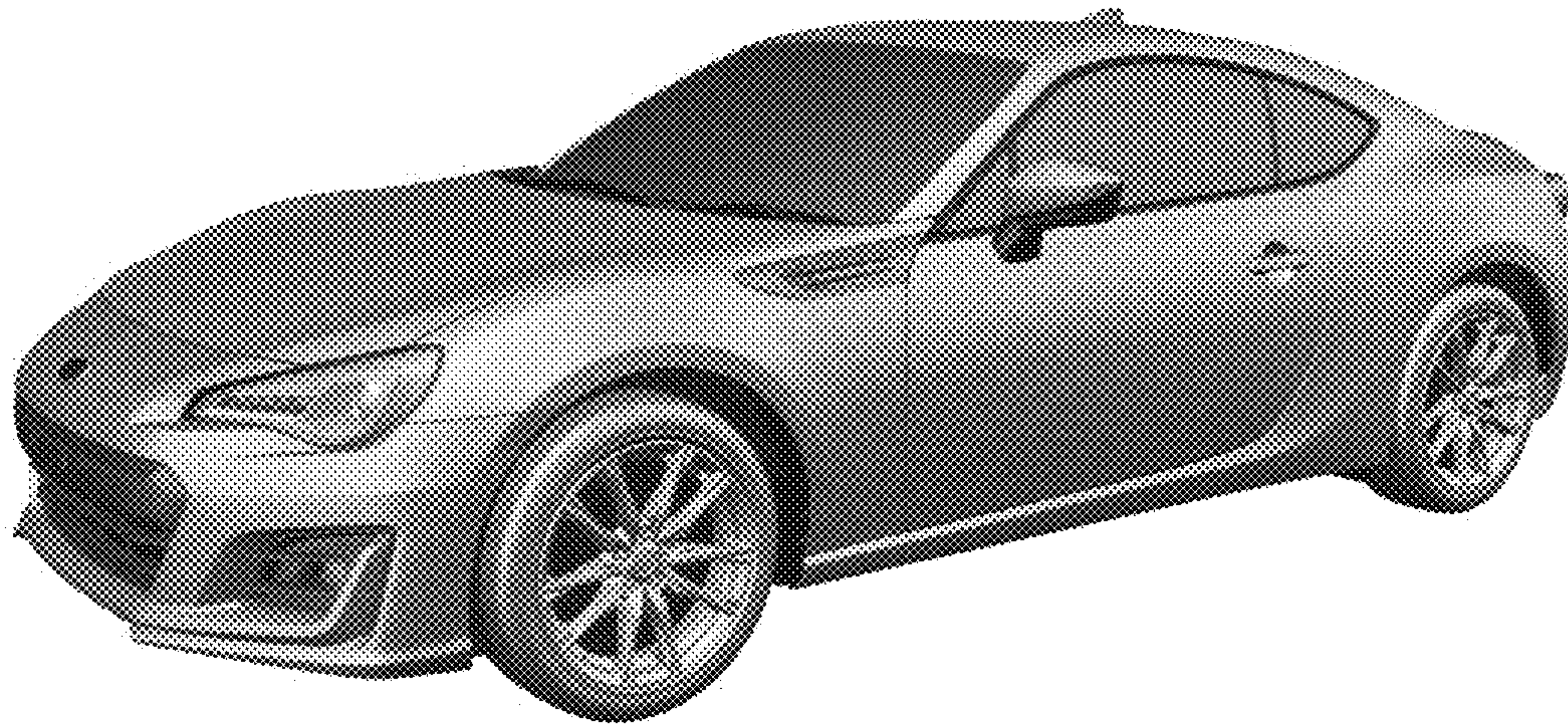

FIG. 1



FIG. 2

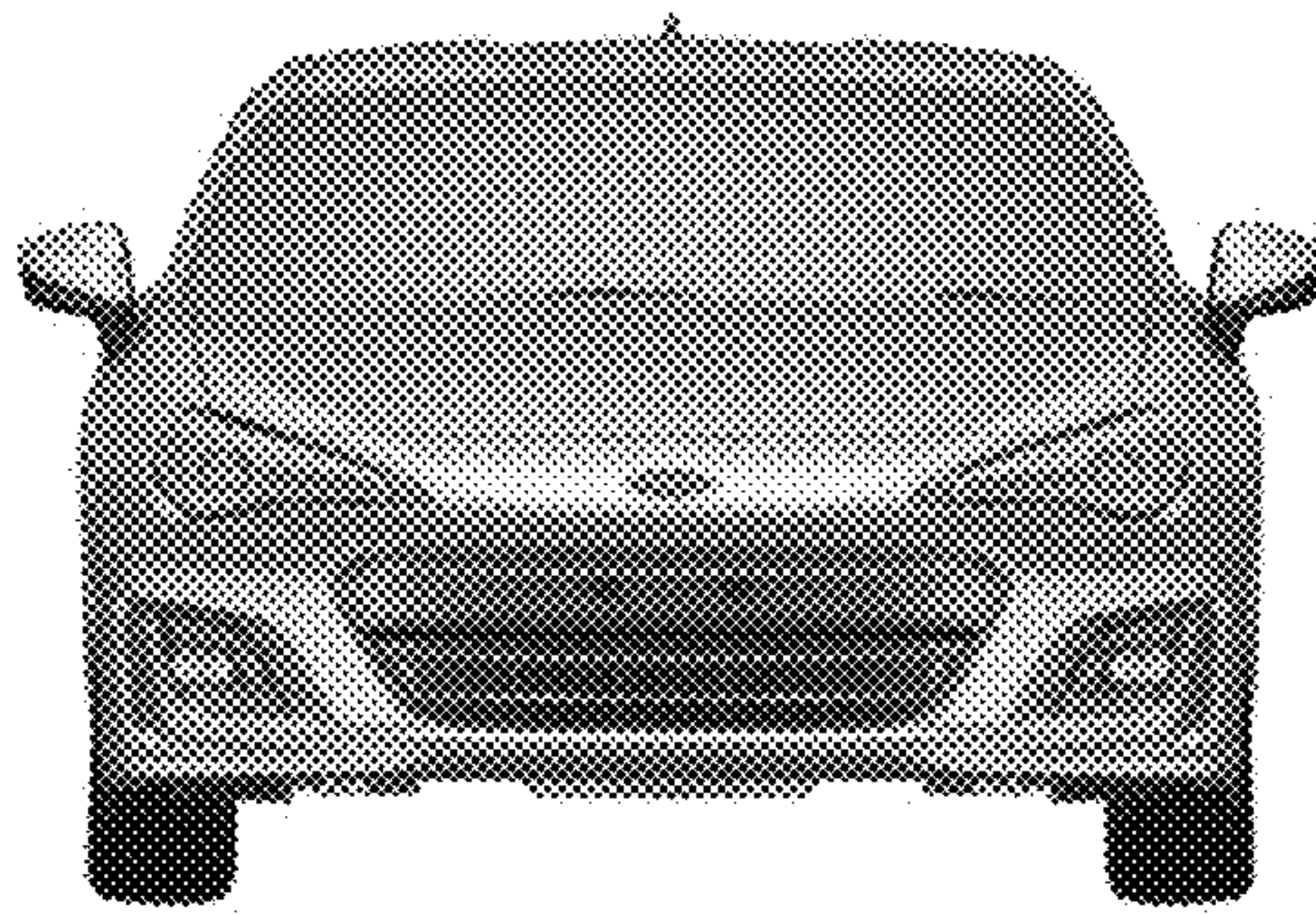

FIG. 3



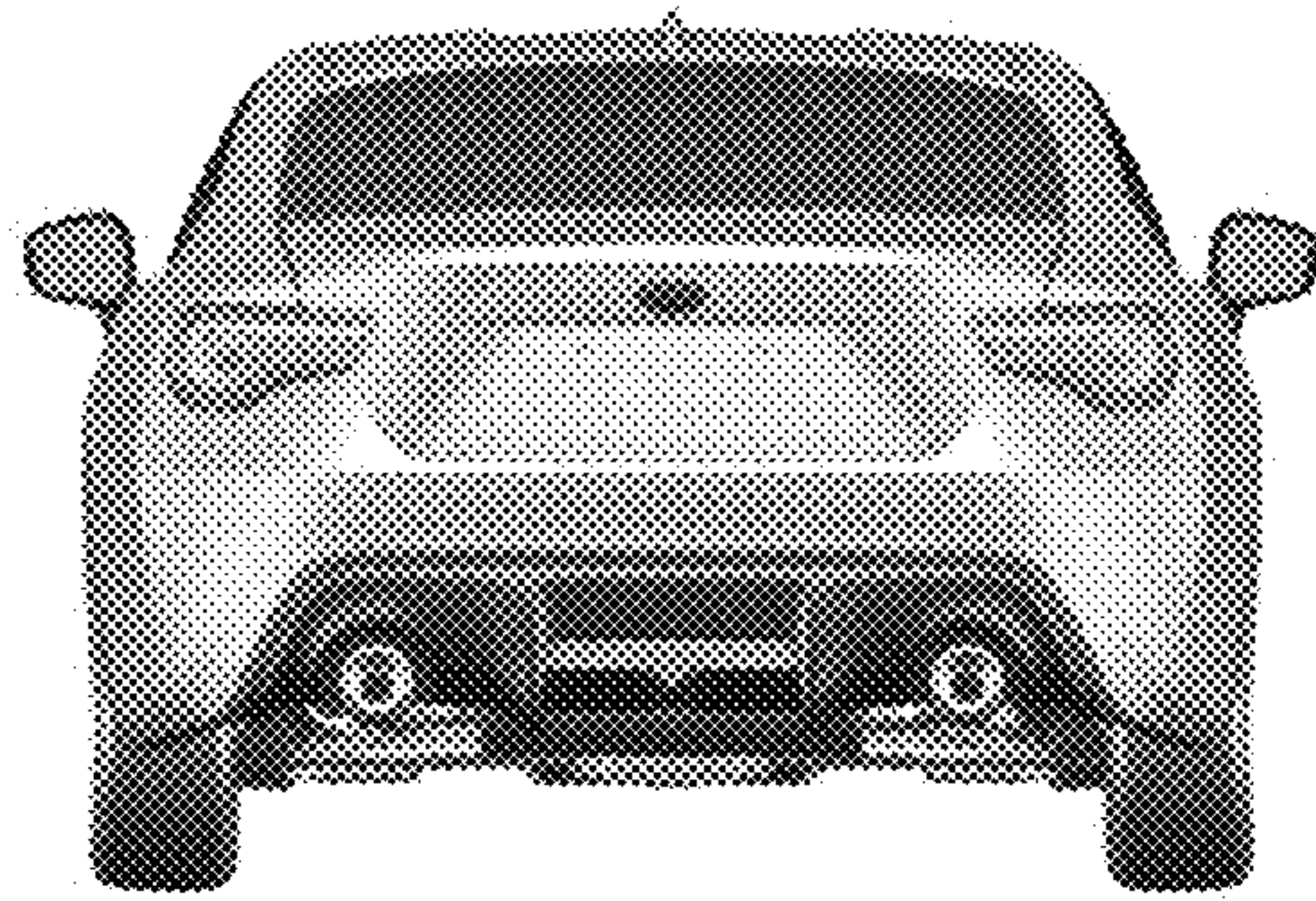

FIG. 4

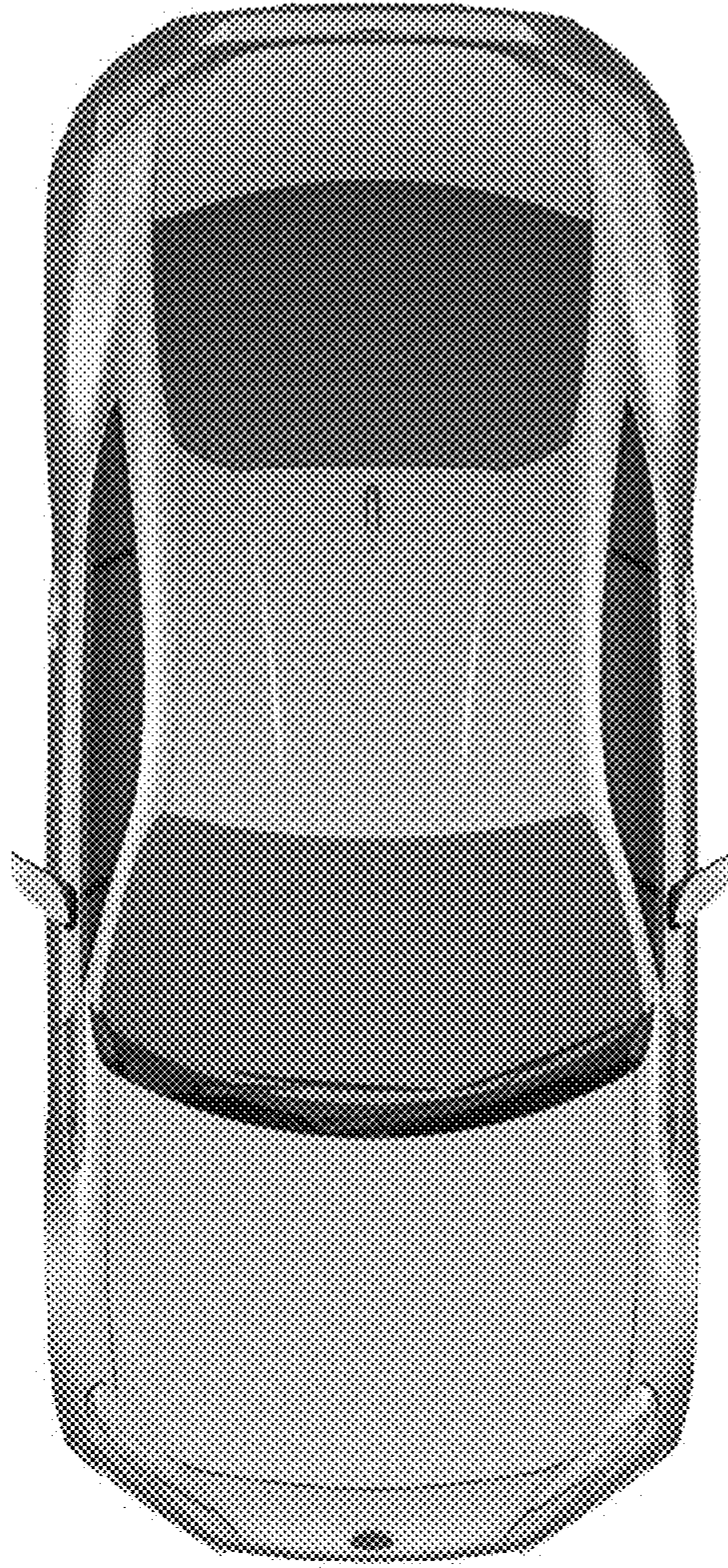

FIG. 5



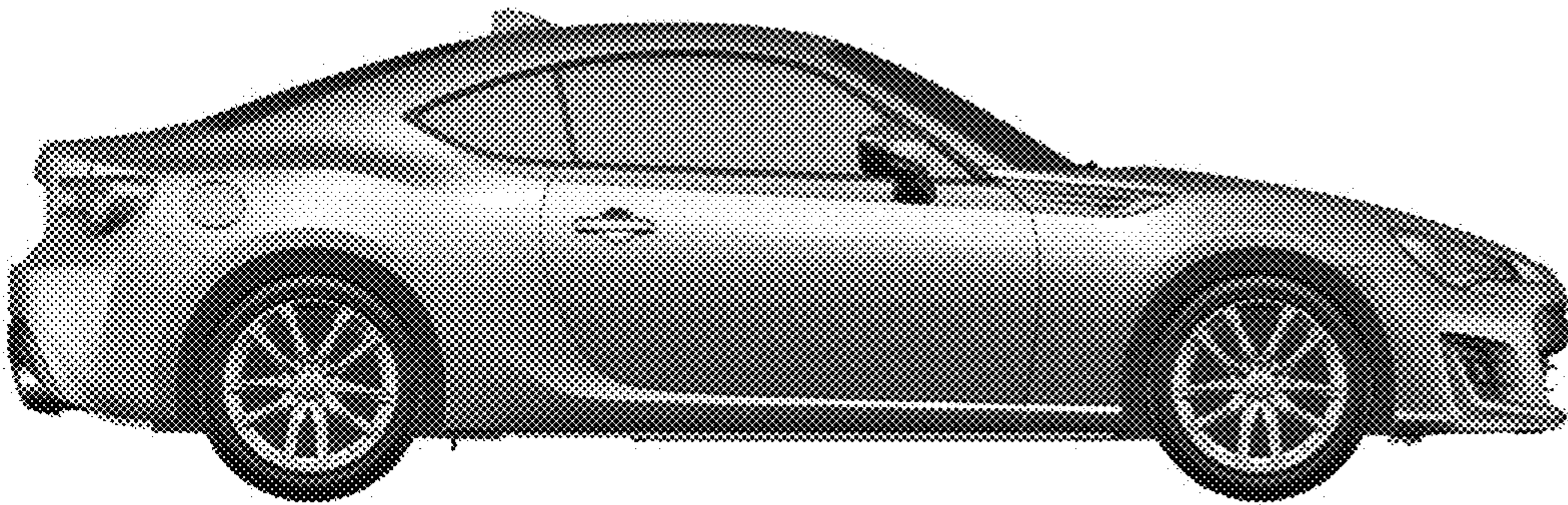

FIG. 6

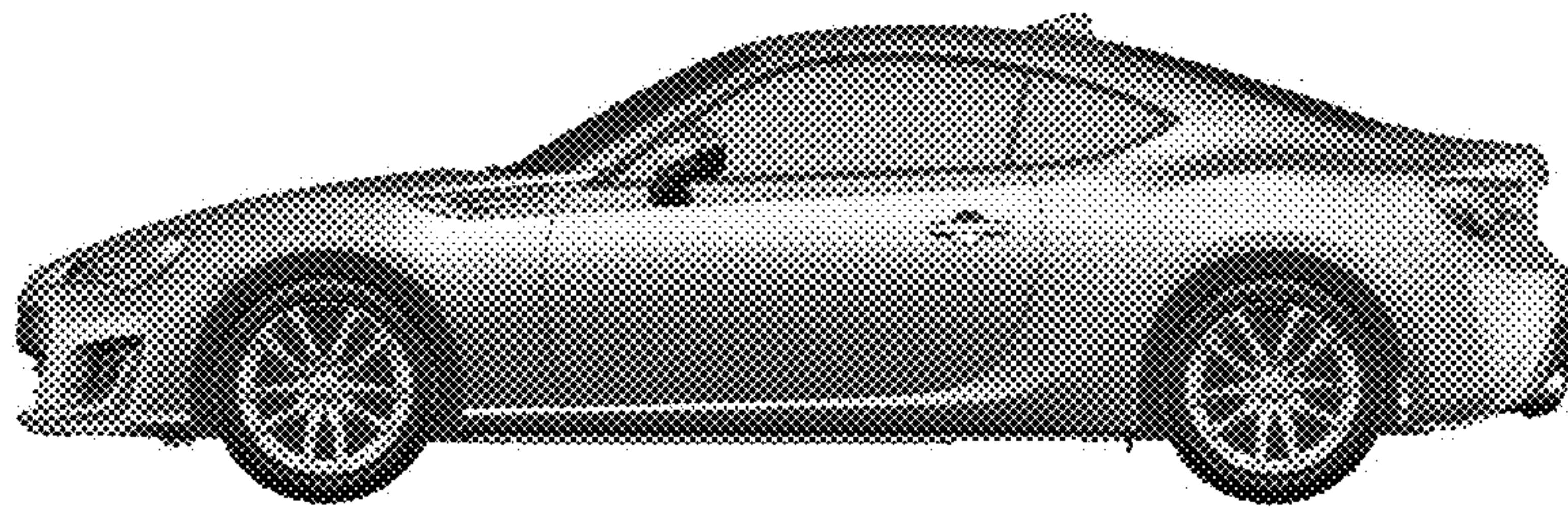

FIG. 7



UNITED STATES PATENT AND TRADEMARK OFFICE  
**CERTIFICATE OF CORRECTION**

PATENT NO. : D797,000 S  
APPLICATION NO. : 29/565108  
DATED : September 12, 2017  
INVENTOR(S) : Yuuki Kumono and Kenji Kamahara

Page 1 of 9

It is certified that error appears in the above-identified patent and that said Letters Patent is hereby corrected as shown below:

On the Title Page

The title page should be deleted and replaced with the title page as shown on the attached page

Item (71) insert:

--Yuuki Kumono, Oura-gun (JP);  
Kenji Kamahara, Oota (JP)--

Item (72) insert:

--Yuuki Kumono, Oura-gun (JP);  
Kenji Kamahara, Oota (JP)--

In the Drawings

Figs. 1-7 should be deleted and replaced with Figs. 1-7 as shown on attached pages

Signed and Sealed this  
Nineteenth Day of December, 2017



Joseph Matal  
*Performing the Functions and Duties of the  
Under Secretary of Commerce for Intellectual Property and  
Director of the United States Patent and Trademark Office*

(12) **United States Design Patent** (10) **Patent No.:** **US D797,000 S**  
**Kumono et al.** (45) **Date of Patent:** **22 Sep. 12, 2017**

(54) **AUTOMOBILE** D762,525 S \* 8/2016 Stopka ..... D12/92  
 D769,154 S \* 10/2016 Varga ..... D12/92  
 D781,798 S \* 3/2017 Manzoni ..... D12/88  
 D784,204 S \* 4/2017 Abdallah ..... D12/92  
 D786,135 S \* 5/2017 Burki ..... D12/92

(71) Applicants: **Yuuki Kumono**, Gunma-ken (JP);  
**Kenji Kamahara**, Oita (JP)

(72) Inventors: **Yuuki Kumono**, Gunma-ken (JP);  
**Kenji Kamahara**, Oita (JP)

(73) Assignees: **Toyota Jidosha Kabushiki Kaisha**  
 (JP); **Fuji Jukogyo Kabushiki Kaisha**  
 (JP)

(2\*) Term: **15 Years**

(21) Appl. No.: **29/565,108**

(22) Filed: **May 18, 2016**

(30) **Foreign Application Priority Data**

Dec. 17, 2015 (JP) ..... 2015-028146

(51) **LOC (10) CL** ..... **12-08**

(52) **U.S. CL**  
 USPC ..... **D12/92**

(58) **Field of Classification Search**  
 USPC ..... D12/86, 90-92, 88; D21/421, 433, 434;  
 296/181.1, 181.5

CPC ..... H62D 35/00; H62D 25/00; H62D 25/06;  
 H62D 33/00

See application file for complete search history.

(56) **References Cited**

**U.S. PATENT DOCUMENTS**

D719,066 S \* 12/2014 Schramm ..... D12/92  
 D751,483 S \* 3/2016 Stopka ..... D12/92  
 D754,565 S \* 4/2016 Varga ..... D12/92  
 D754,566 S \* 4/2016 Varga ..... D12/92  
 D755,677 S \* 5/2016 Stopka ..... D12/92  
 D757,609 S \* 5/2016 Stopka ..... D12/92  
 D757,810 S \* 5/2016 Stopka ..... D12/92

**OTHER PUBLICATIONS**

Toyota, *Toyota 86* (2013), Catalogue of Toyota 86, Toyota Jidosha Kabushiki Kaisha, available at least as early as Jul. 1, 2013.

Fuji Jukogyo Kabushiki Kaisha, *Subaru BRZ* (2012), Response.jp <<http://response.jp/article/2012.02/09/169774.html>>, available at least as early as Dec. 1, 2014.

\* cited by examiner

*Primary Examiner* Melody N Brown

(74) *Attorney, Agent, or Firm* --- Saidman DesignLaw Group, LLC

(57) **CLAIM**

The ornamental design for an automobile, as shown and described.

**DESCRIPTION**

FIG. 1 is a front and right side perspective view of an automobile showing our new design;  
 FIG. 2 is a rear and right side perspective view thereof;  
 FIG. 3 is a front view thereof;  
 FIG. 4 is a rear view thereof;  
 FIG. 5 is a top view thereof;  
 FIG. 6 is a left side view thereof; and,  
 FIG. 7 is a right side view thereof.

The various shades of gray as well as the shadows and reflections represent contour and not surface ornamentation or any particular color.

**1 Claim, 7 Drawing Sheets**

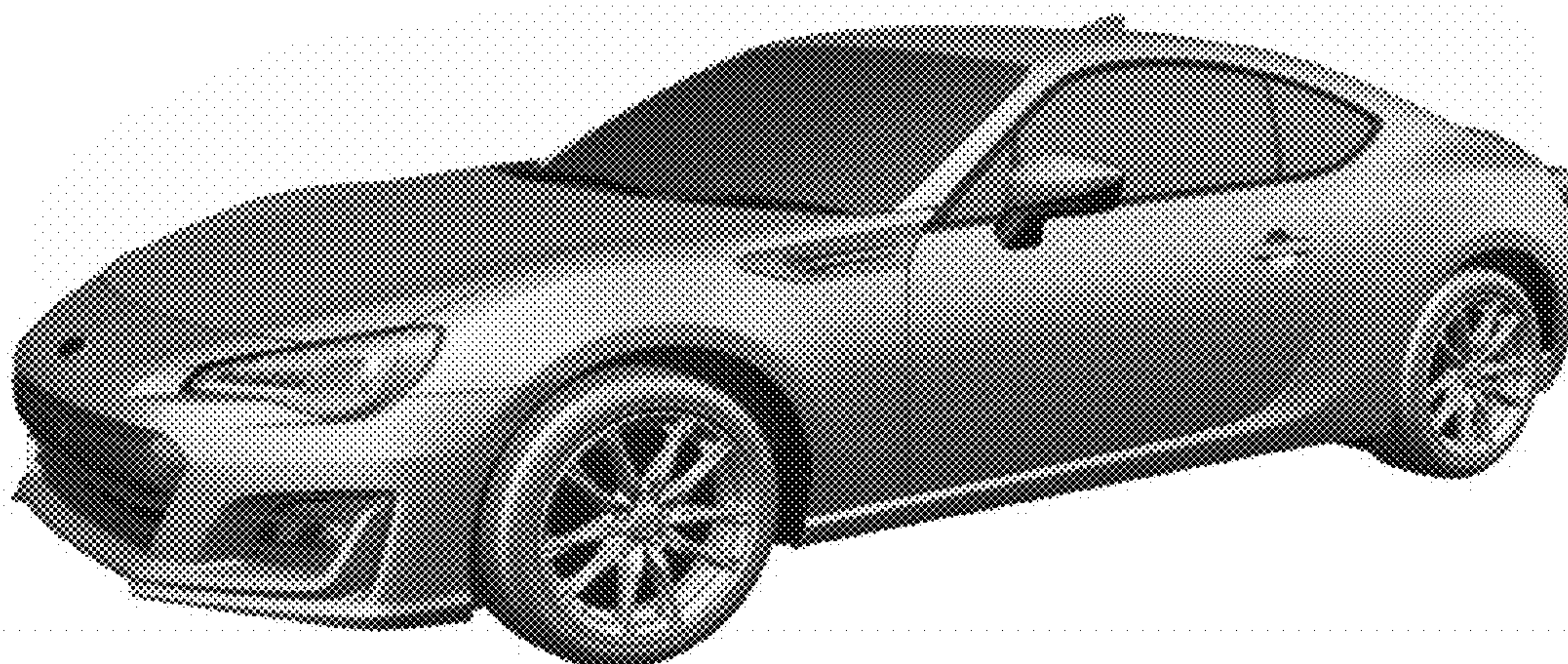





FIG. 1

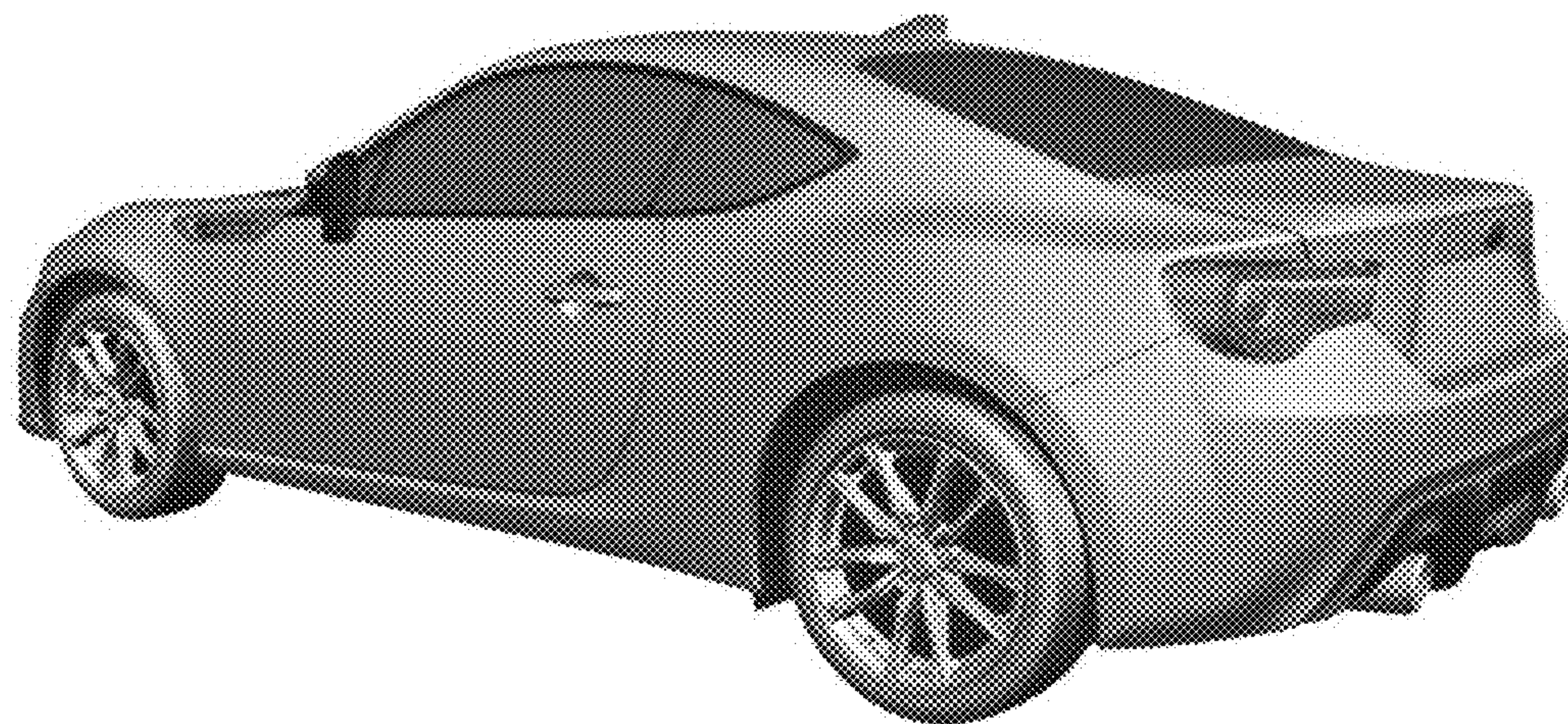

FIG. 2





FIG. 3

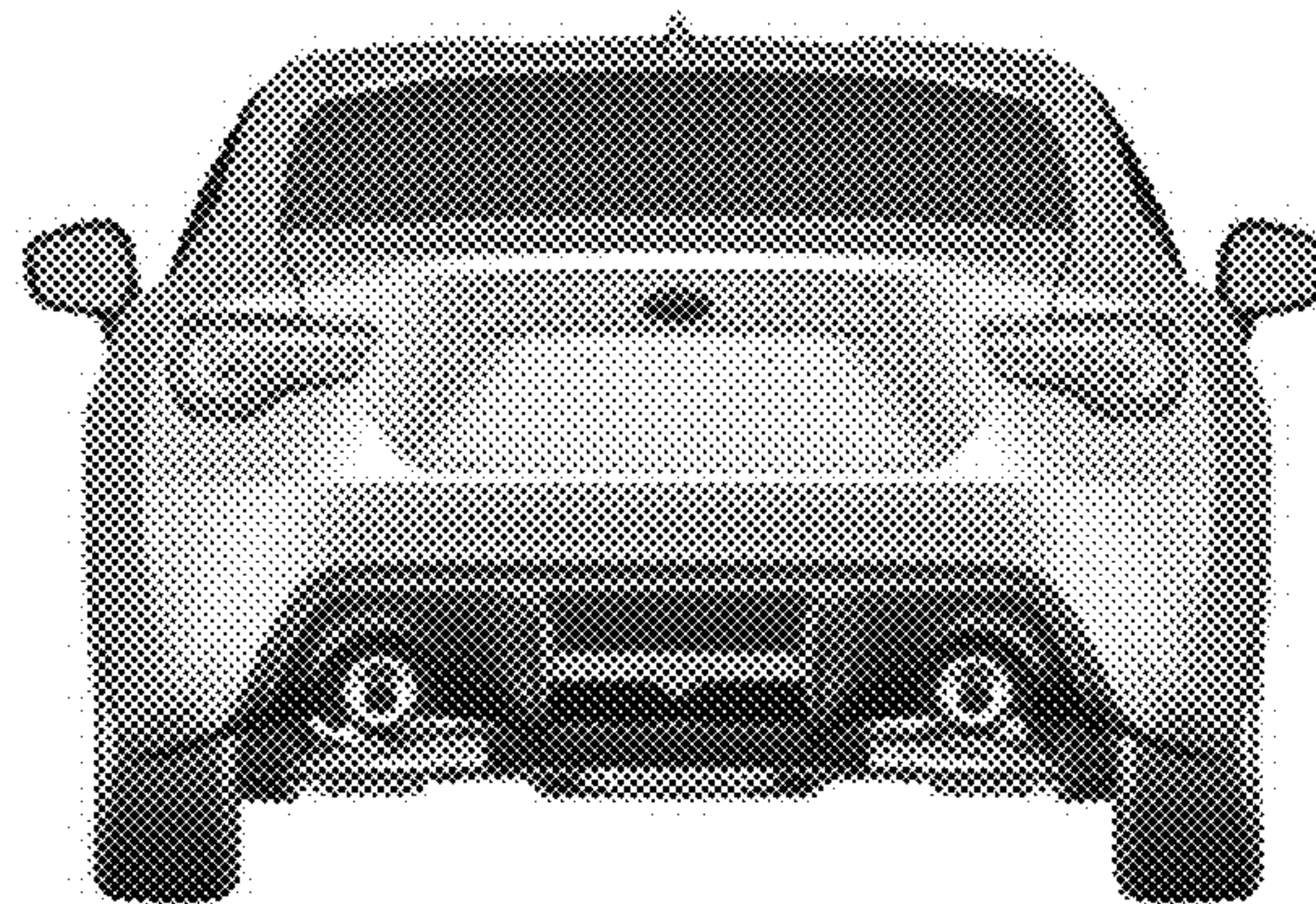

FIG. 4



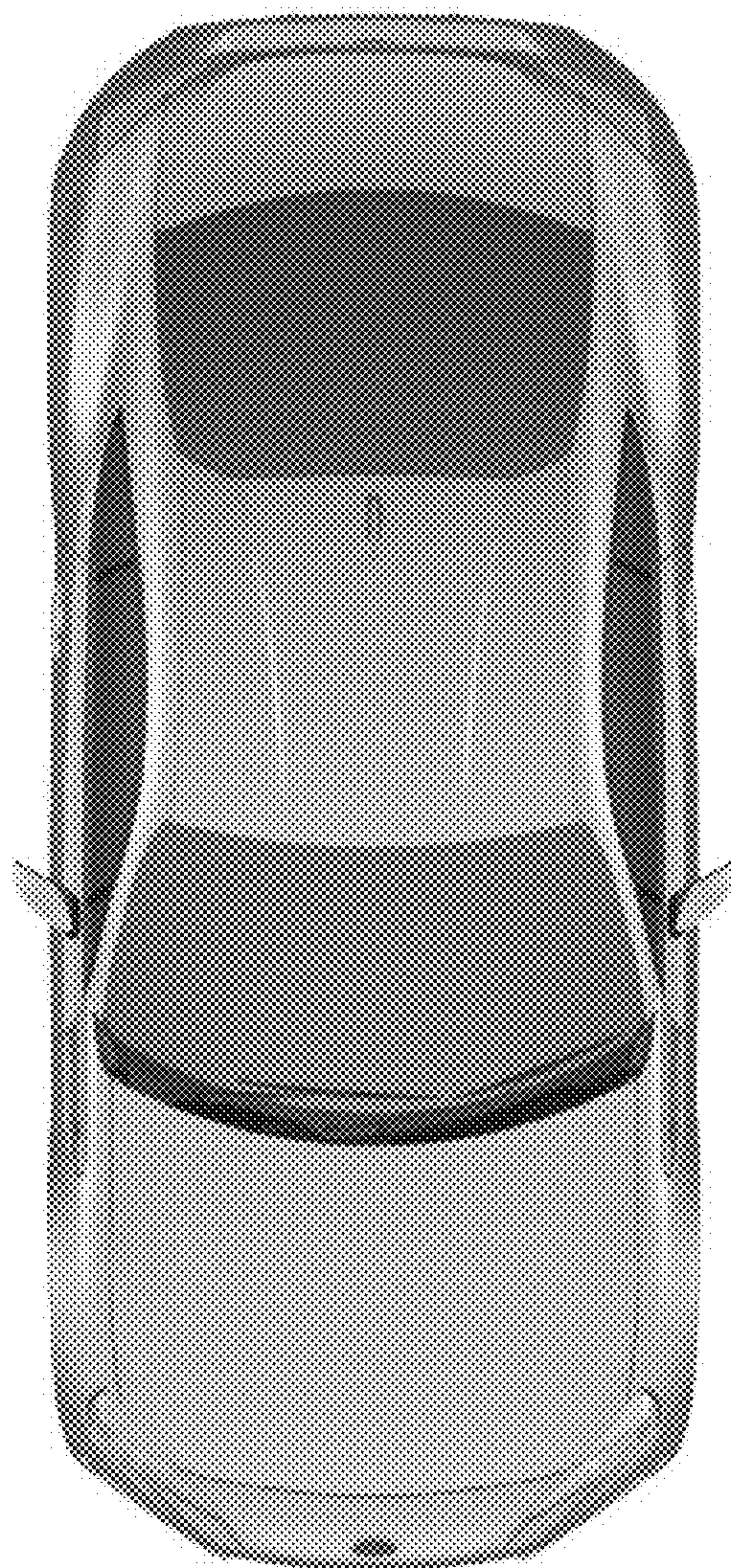

FIG. 5

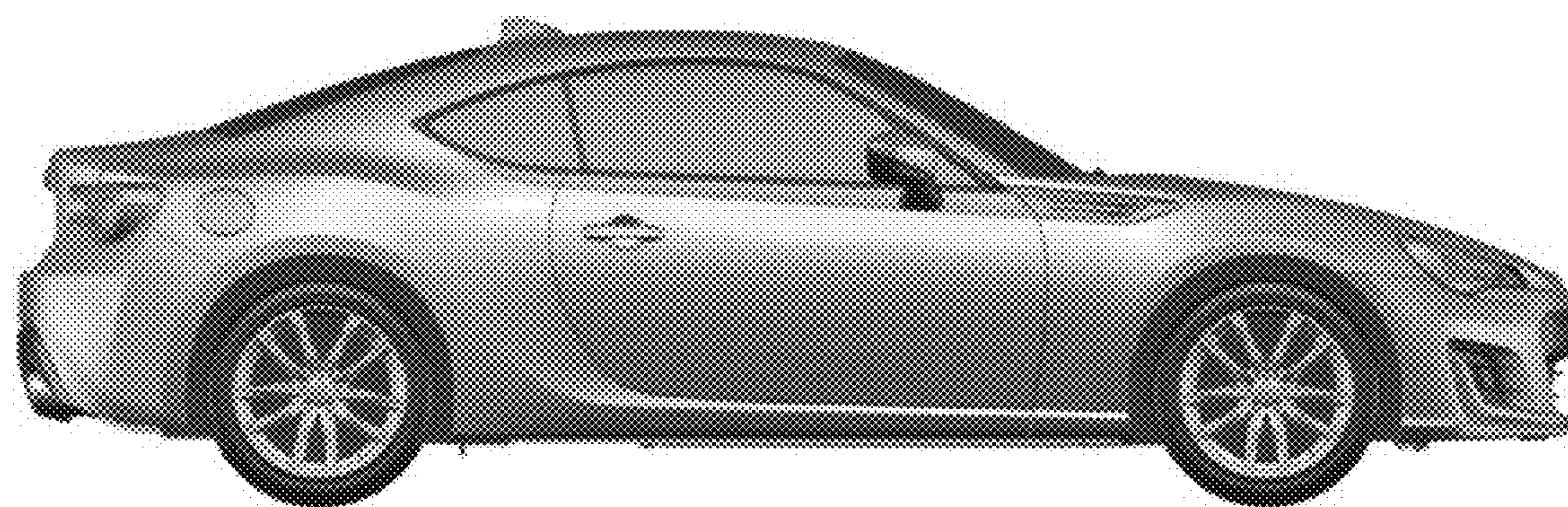

FIG. 6



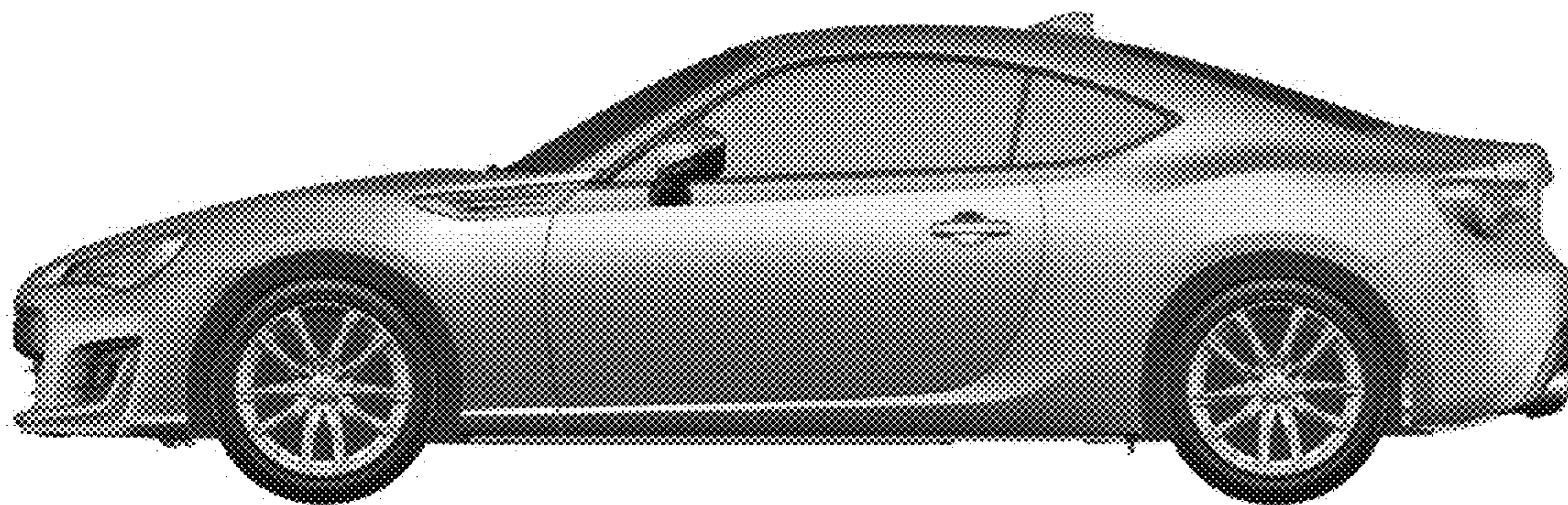

FIG. 7

UNITED STATES PATENT AND TRADEMARK OFFICE  
**CERTIFICATE OF CORRECTION**

PATENT NO. : D797,000 S  
APPLICATION NO. : 29/565108  
DATED : September 12, 2017  
INVENTOR(S) : Yuuki Kumono and Kenji Kamahara

Page 1 of 9

It is certified that error appears in the above-identified patent and that said Letters Patent is hereby corrected as shown below:

On the Title Page

The title page should be deleted and replaced with the title page as shown on the attached page

In the Drawings

Figs. 1-7 should be deleted and replaced with Figs. 1-7 as shown on attached pages

This certificate supersedes the Certificate of Correction issued December 19, 2017.

Signed and Sealed this  
Twenty-ninth Day of May, 2018

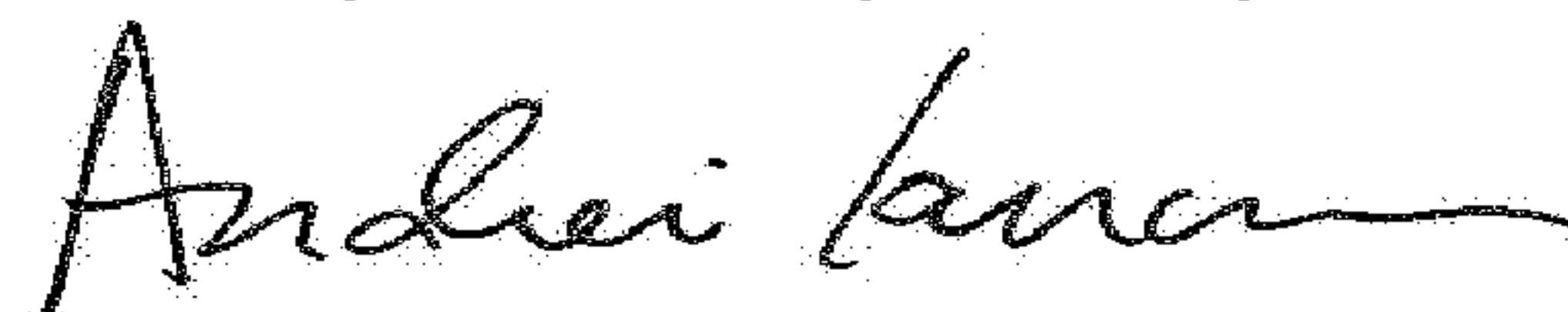

Andrei Iancu  
*Director of the United States Patent and Trademark Office*



(12) **United States Design Patent** (10) **Patent No.:** **US D797,000 S**  
**Kumono et al.** (45) **Date of Patent:** **\*\* Sep. 12, 2017**

(54) **AUTOMOBILE**

(71) Applicants: **Yuuki Kumono, Oota-gun (JP);**  
**Kenji Kamahara, Oota (JP)**

(72) Inventors: **Yuuki Kumono, Oota-gun (JP);**  
**Kenji Kamahara, Oota (JP)**

(73) Assignees: **Toyota Jidosha Kabushiki Kaisha**  
**(JP); Fuji Jukogyo Kabushiki Kaisha**  
**(JP)**

(\*\*\*) Term: **15 Years**

(21) Appl. No.: **29/565,108**

(22) Filed: **May 18, 2016**

(30) **Foreign Application Priority Data**

Dec. 17, 2015 (JP) ..... 2015-028146

(51) **LOC (10) CL.** ..... **12-08**

(52) **U.S. CL.**  
**USPC** ..... **D12/92**

(58) **Field of Classification Search**  
**USPC** ..... **D12/86, 90-92, 88; D21/421, 433, 434;**  
**296/181.1, 181.5**  
**CPC** ..... **B62D 35/00; B62D 25/00; B62D 25/06;**  
**B62D 33/00**  
 See application file for complete search history.

(56) **References Cited**

**U.S. PATENT DOCUMENTS**

D719,066 S \* 12/2014 Schramm ..... D12/92  
 D751,465 S \* 3/2016 Stopka ..... D12/92  
 D754,565 S \* 4/2016 Varga ..... D12/92  
 D754,568 S \* 4/2016 Varga ..... D12/92  
 D755,877 S \* 5/2016 Stopka ..... D12/92  
 D757,609 S \* 5/2016 Stopka ..... D12/92  
 D757,610 S \* 5/2016 Stopka ..... D12/92

D762,525 S \* 8/2016 Stopka ..... D12/92  
 D769,154 S \* 10/2016 Varga ..... D12/92  
 D781,798 S \* 3/2017 Mazzoni ..... D12/92  
 D784,204 S \* 4/2017 Abdallah ..... D12/92  
 D786,135 S \* 5/2017 Burki ..... D12/92

**OTHER PUBLICATIONS**

Toyota, Toyota 86 (2013), Catalogue of Toyota 86, Toyota Jidosha Kabushiki Kaisha, available at least as early as Jul. 1, 2013.  
 Fuji Jukogyo Kabushiki Kaisha, Subaru BRZ (2012), Response.jp <http://response.jp/article/2012/02/09/369774.html>, available at least as early as Dec. 1, 2014.

\* cited by examiner

*Primary Examiner* — Melody N Brown

(74) *Attorney, Agent, or Firm* — Soidman Design, LLC  
 Group, LLC

(57) **CLAIM**

The ornamental design for an automobile, as shown and described.

**DESCRIPTION**

FIG. 1 is a front and right side perspective view of an automobile showing our new design;  
 FIG. 2 is a rear and right side perspective view thereof;  
 FIG. 3 is a front view thereof;  
 FIG. 4 is a rear view thereof;  
 FIG. 5 is a top view thereof;  
 FIG. 6 is a left side view thereof; and,  
 FIG. 7 is a right side view thereof.  
 The various shades of gray as well as the shadows and reflections represent contour and not surface ornamentation or any particular color.

**1 Claim, 7 Drawing Sheets**





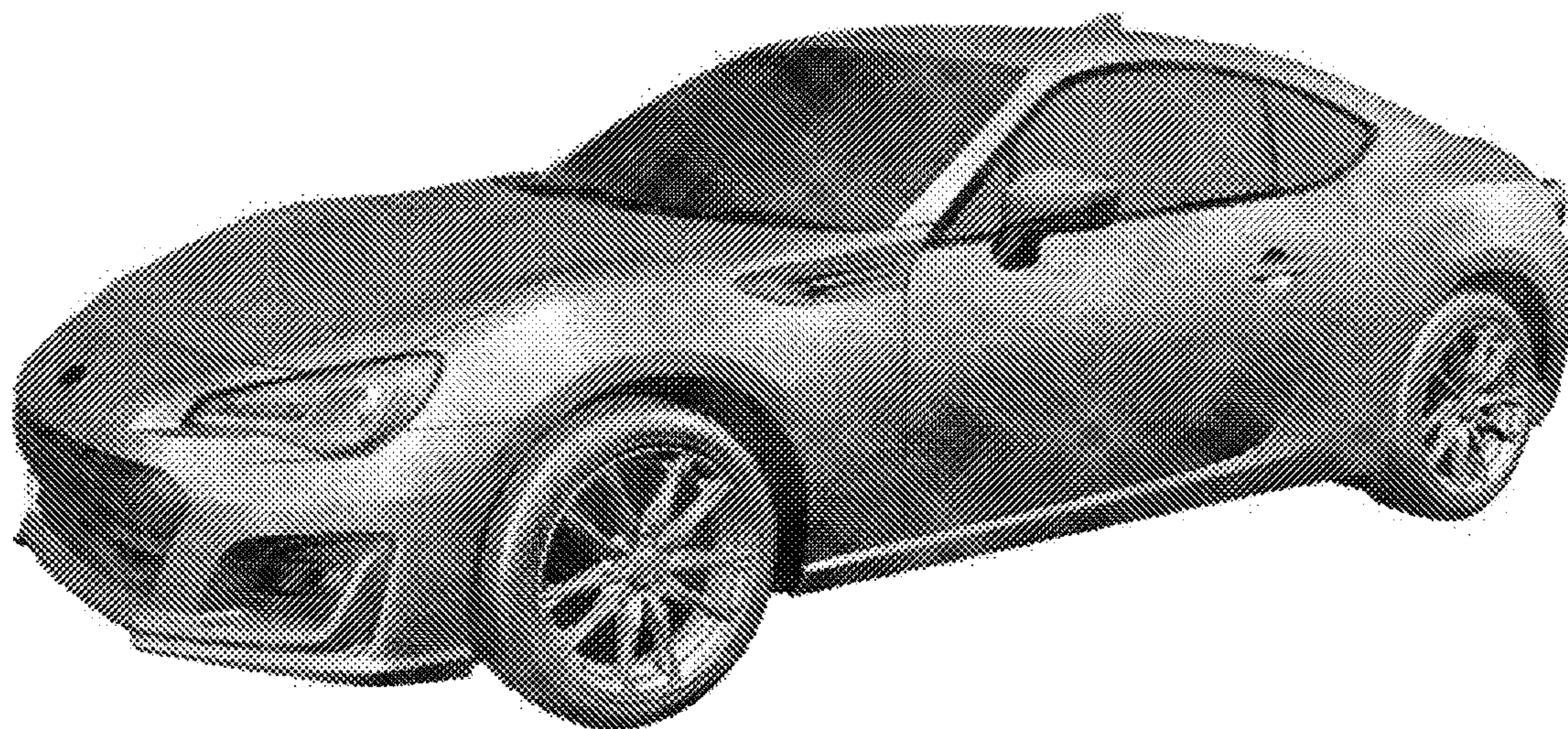

FIG. 1



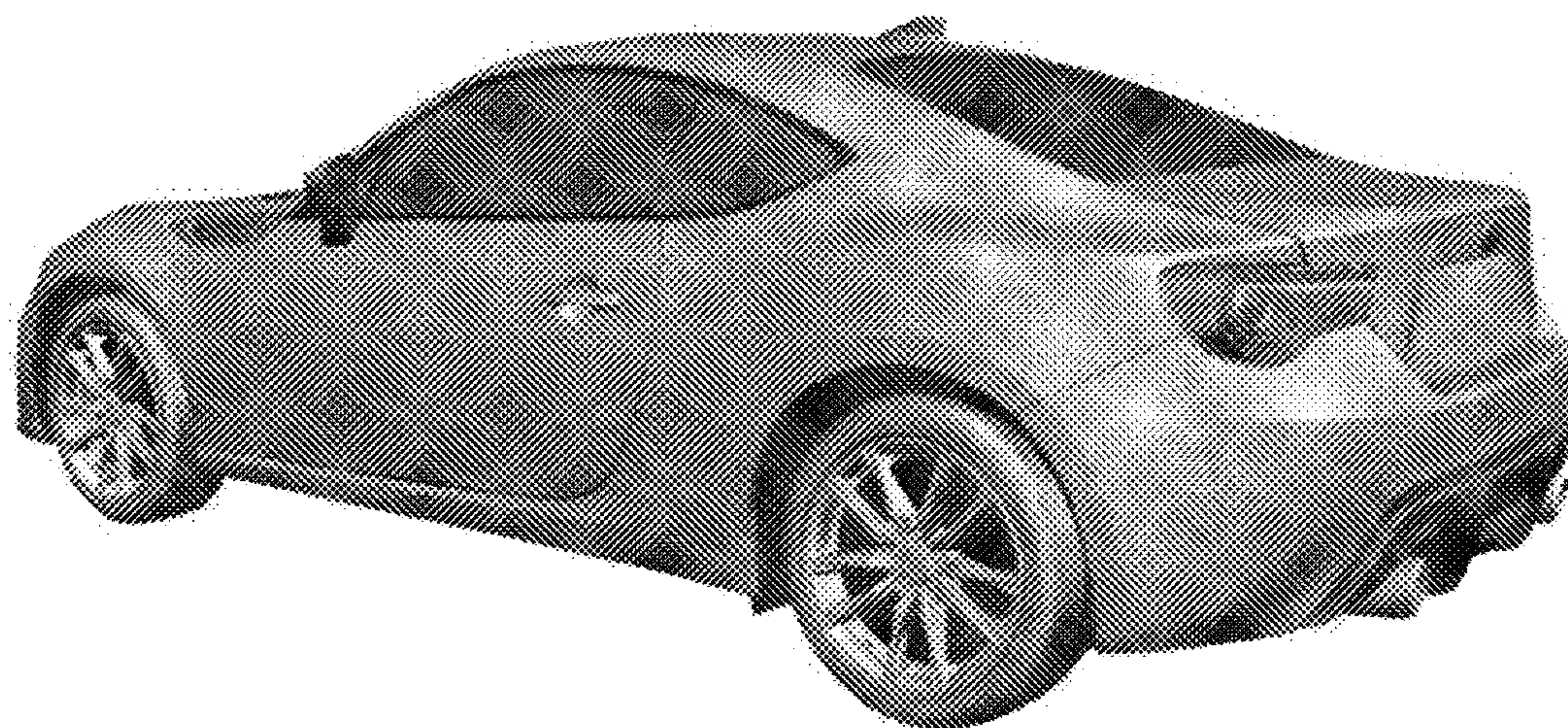

FIG. 2

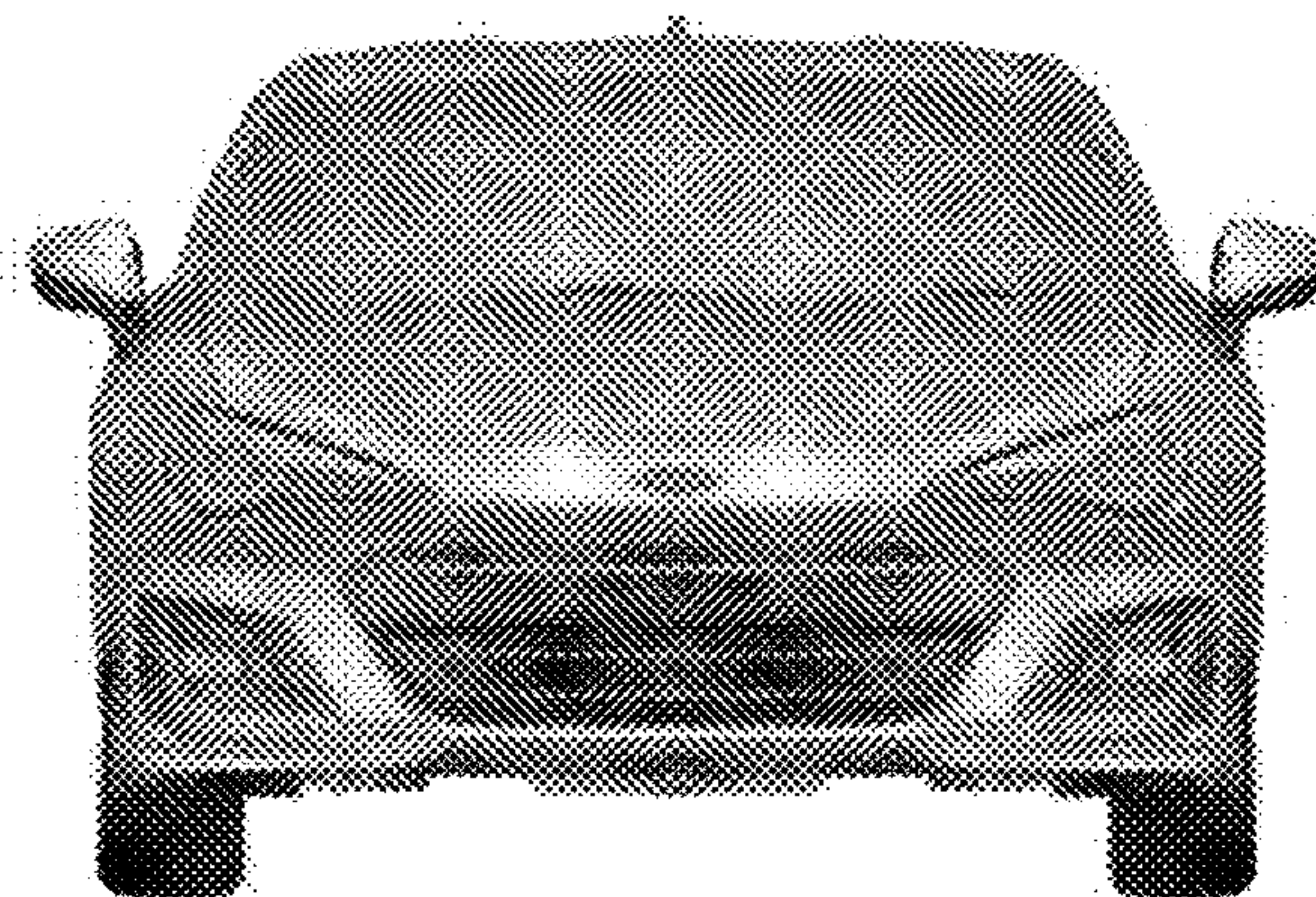

FIG. 3



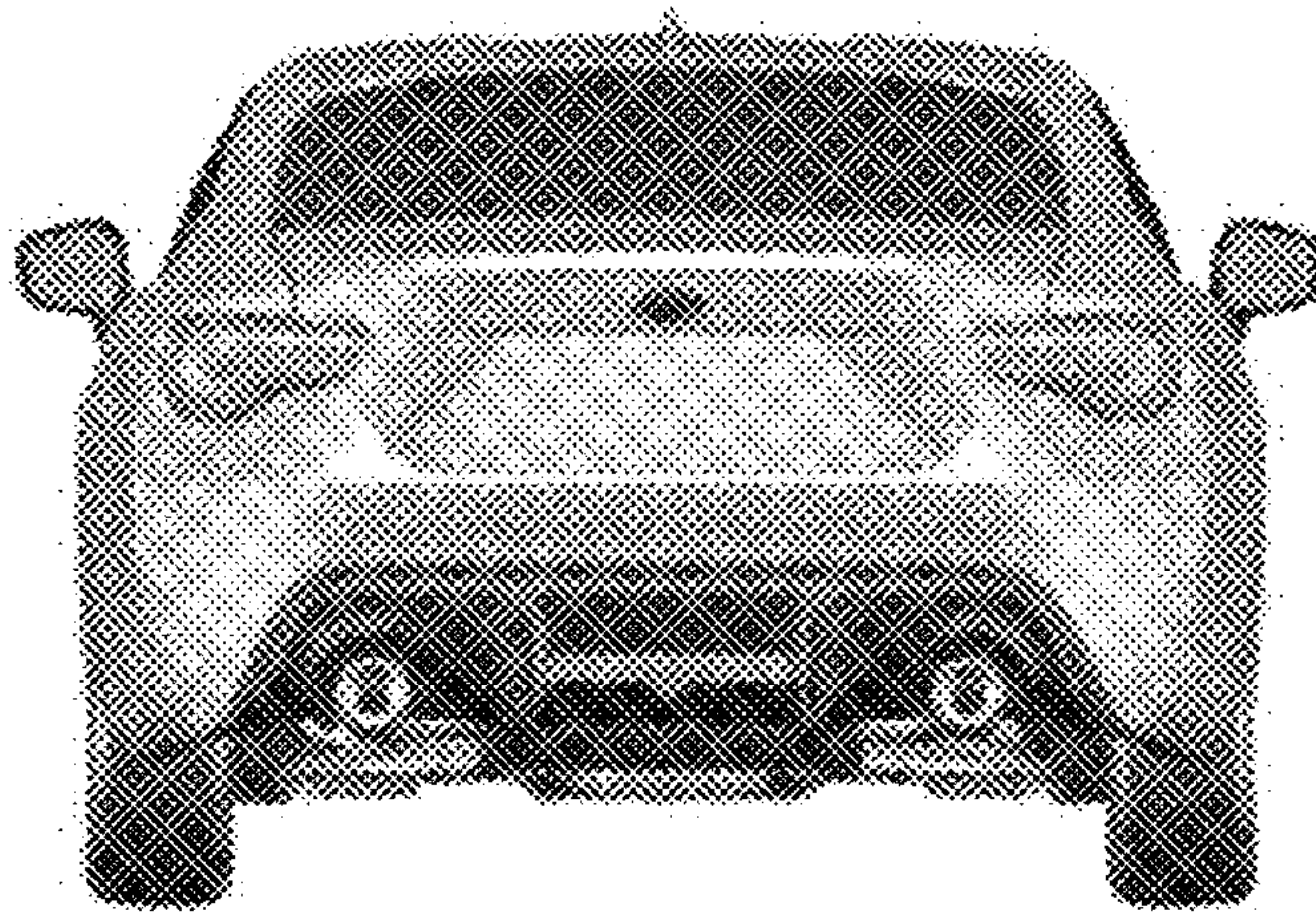

FIG. 4



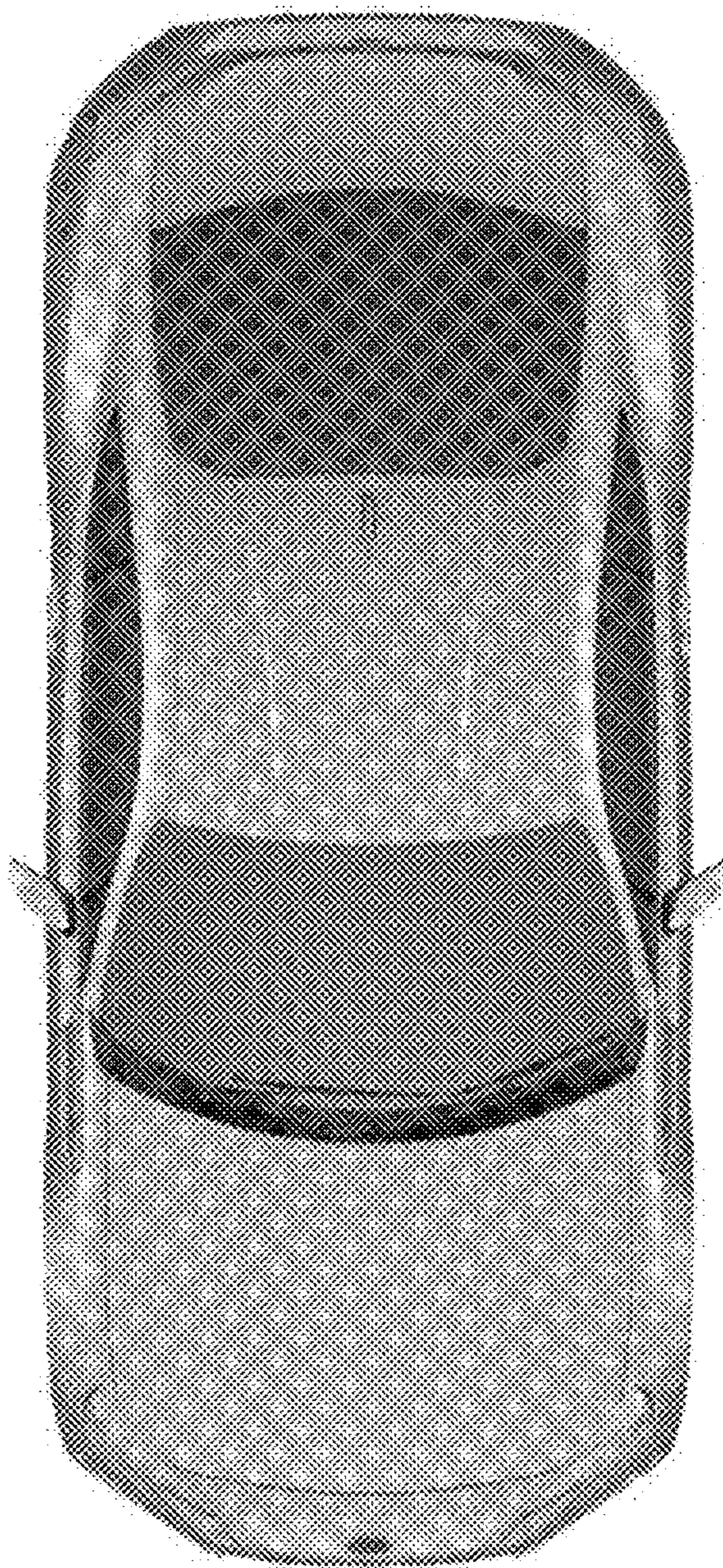

FIG. 5



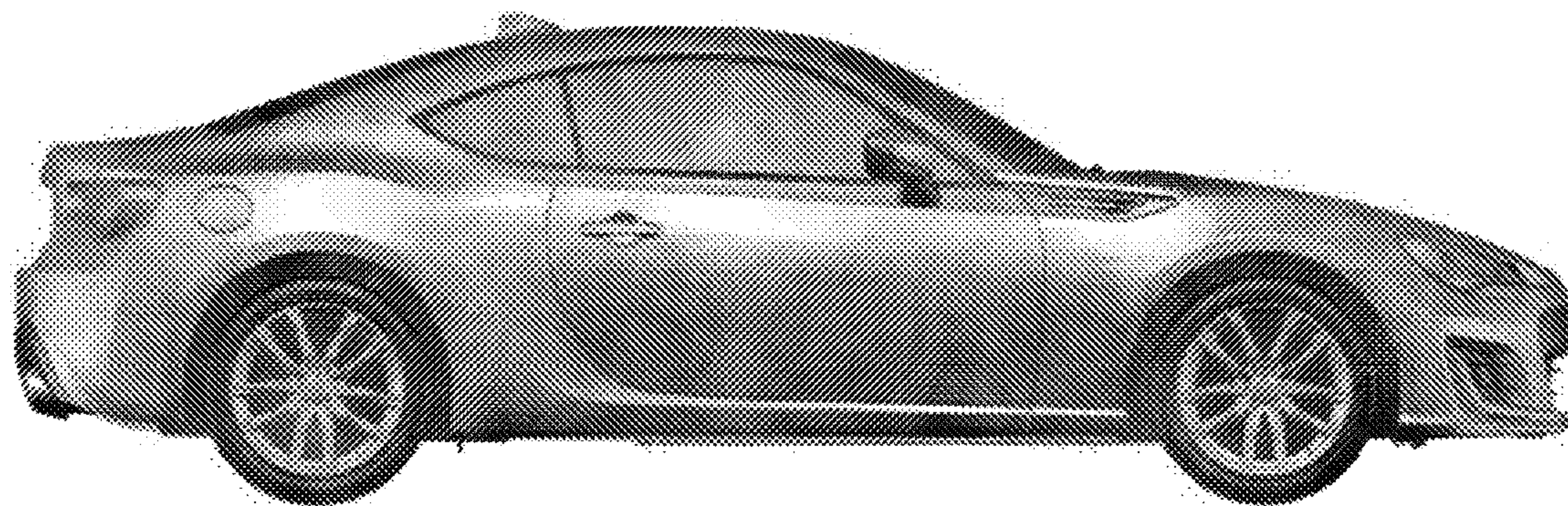

FIG. 6

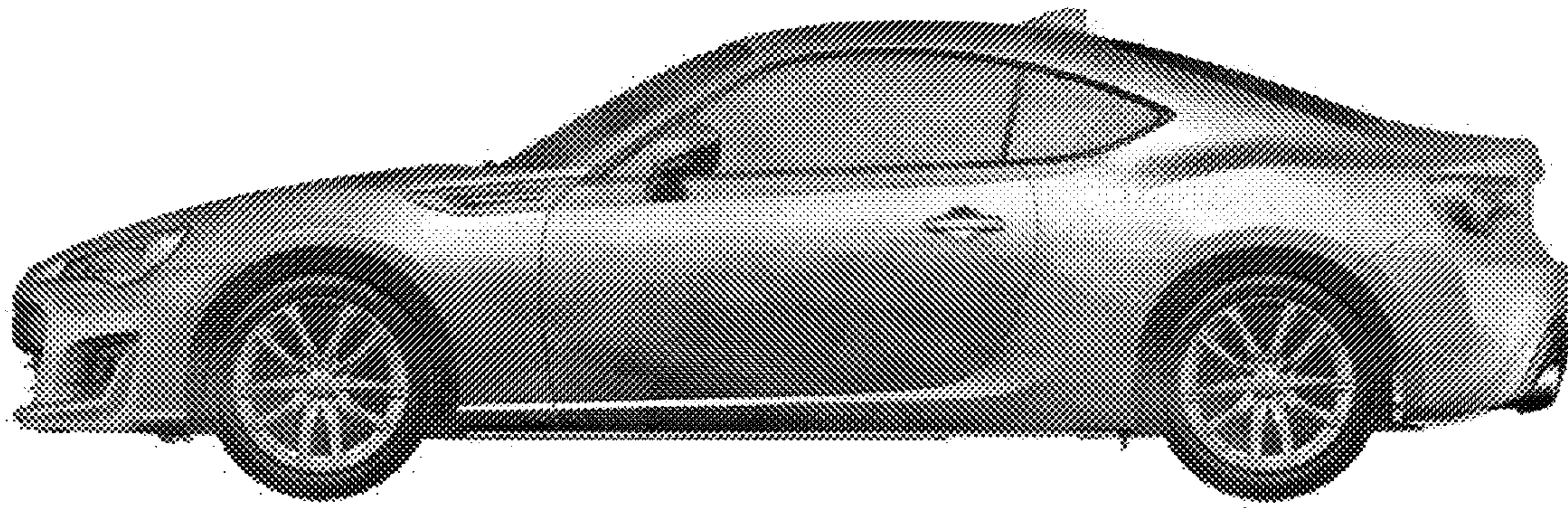

FIG. 7