



US00D796882S

(12) **United States Design Patent**
De Bruin et al.

(10) **Patent No.:** **US D796,882 S**

(45) **Date of Patent:** **** Sep. 12, 2017**

(54) **SUPPORTING FOOT FOR CABINETS OR FURNITURE**

(71) Applicant: **DESIGNERSCOPE LIMITED**,
Auckland (NZ)

(72) Inventors: **Wim Jan De Bruin**, Auckland (NZ);
Jamie Stewart Booth, Auckland (NZ)

(73) Assignee: **DESIGNERSCOPE LIMITED**,
Auckland (NZ)

(**) Term: **14 Years**

(21) Appl. No.: **29/503,581**

(22) Filed: **Sep. 26, 2014**

(30) **Foreign Application Priority Data**

Mar. 28, 2014 (NZ) 418683
Mar. 28, 2014 (NZ) 418684

(51) **LOC (10) Cl.** **06-06**

(52) **U.S. Cl.**
USPC **D6/710**

(58) **Field of Classification Search**
USPC D6/334, 708, 710-711; D15/126, 139,
D15/148; D8/15, 70; D32/25; D9/429
(Continued)

(56) **References Cited**

U.S. PATENT DOCUMENTS

D62,960 S * 8/1923 Pettibone D6/710
D230,235 S * 2/1974 Green D6/710
(Continued)

OTHER PUBLICATIONS

Plastic plint legs. [online] Published date unknown. Retrieved on
Sep. 9, 2016 from <URL: <http://www.shopmancini.com/en/accessories-for-furniture/2370-plastic-plint-legs.html>>.*

(Continued)

Primary Examiner — Vy Koenig
Assistant Examiner — Omeed Agilee
(74) *Attorney, Agent, or Firm* — Morrison & Foerster
LLP

(57) **CLAIM**

The ornamental design for a supporting foot for cabinets or furniture, as shown and described.

DESCRIPTION

FIG. 1 is a front, side, and top perspective view of the first embodiment of a supporting foot for cabinets or furniture, showing our new design;
FIG. 2 is a front, side, and bottom perspective view of the first embodiment;
FIG. 3 is a top view of the first embodiment;
FIG. 4 is a bottom view of the first embodiment;
FIG. 5 is a front view of the first embodiment;
FIG. 6 is a side view of the first embodiment;
FIG. 7 is a front, side, and top perspective view of the second embodiment of the foot;
FIG. 8 is a front, side, and bottom perspective view of the second embodiment;
FIG. 9 is a top view of the second embodiment;
FIG. 10 is a bottom view of the second embodiment;
FIG. 11 is a front view of the second embodiment;
FIG. 12 is a side view of the second embodiment;
FIG. 13 is a front, side, and top perspective view of the third embodiment of the foot;
FIG. 14 is a front, side, and bottom perspective view of the third embodiment;
FIG. 15 is a top view of the third embodiment;
FIG. 16 is a bottom view of the third embodiment;
FIG. 17 is a front view of the third embodiment; and,
FIG. 18 is a side view of the third embodiment.
The broken line showing of portions of the foot forms no part of the claimed design.

1 Claim, 18 Drawing Sheets

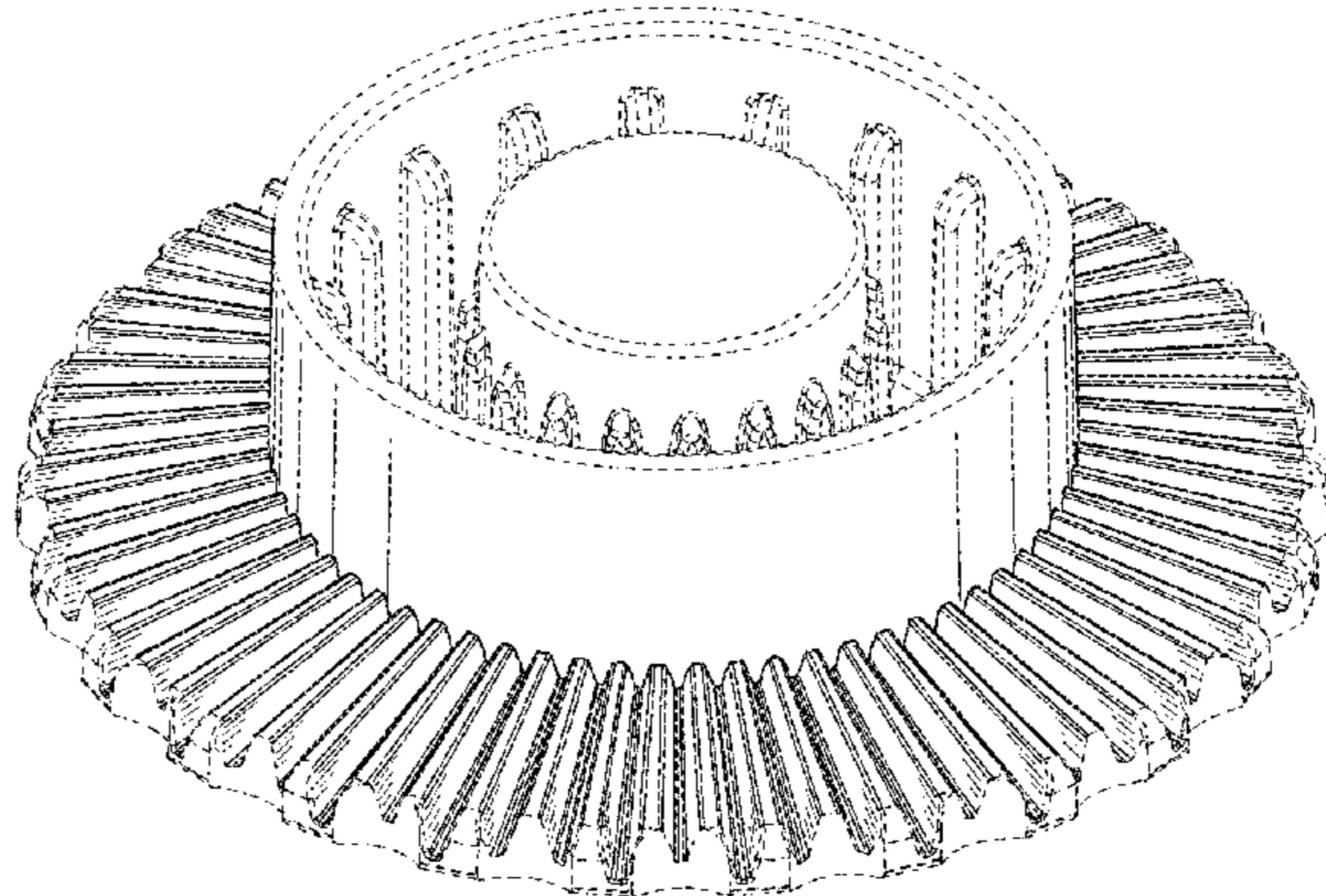
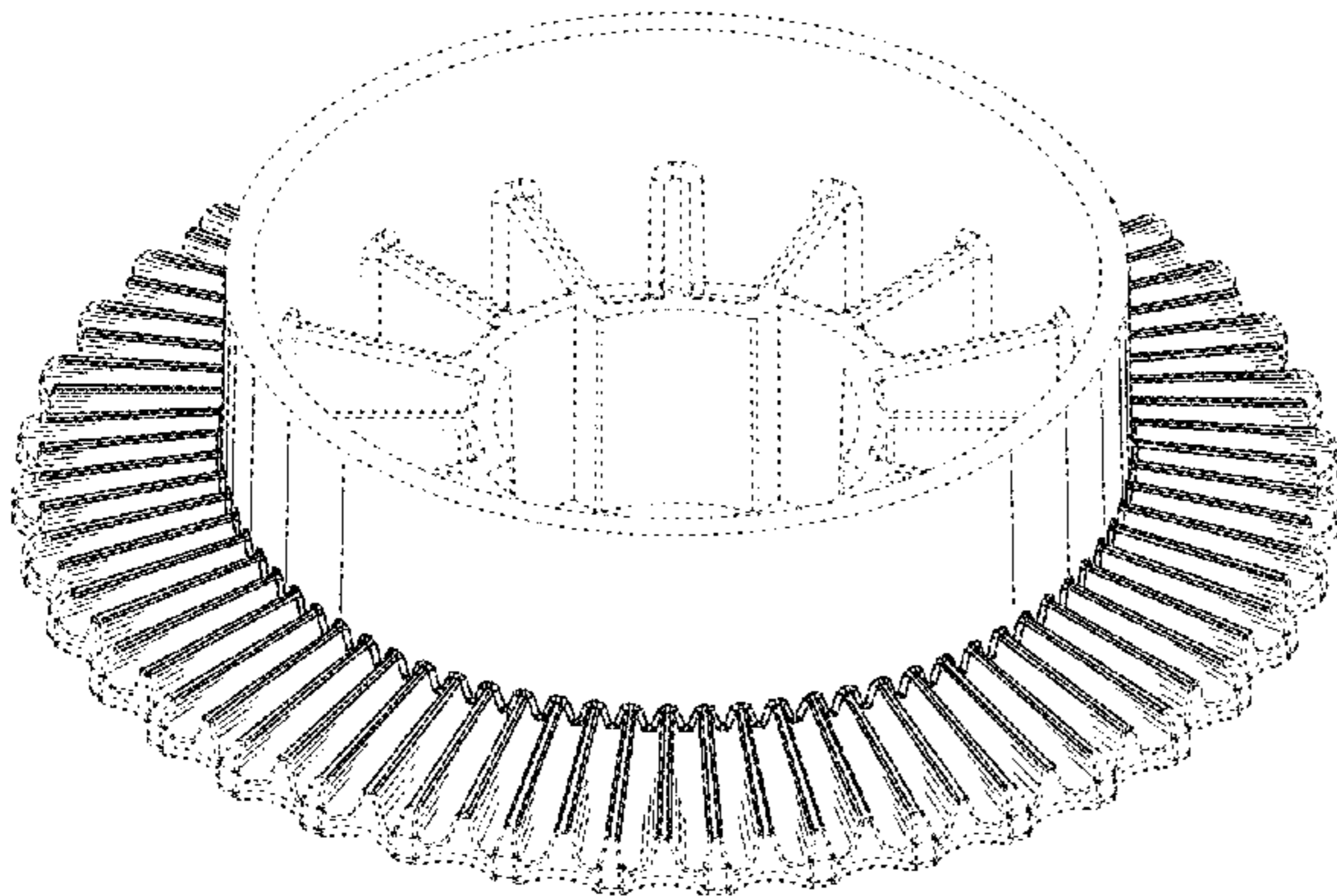

(58) **Field of Classification Search**

CPC A47B 91/02
See application file for complete search history.

(56) **References Cited**

U.S. PATENT DOCUMENTS

D281,300 S * 11/1985 Gluck D6/708
D296,900 S * 7/1988 Randolph D15/148
D345,912 S * 4/1994 Krupa D9/425
D346,554 S * 5/1994 Krupa D9/429
D349,832 S * 8/1994 Sarnoff D7/547
D358,091 S * 5/1995 Warburton D9/425
D762,115 S * 7/2016 Corvaglia D9/443
2004/0195475 A1 * 10/2004 Felsenthal A47B 91/02
248/188.9
2016/0235200 A1 * 8/2016 De Bruin A47B 91/02

OTHER PUBLICATIONS

Pictures of a product manufactured by Camar S.p.A. (see explanation of relevance and publication date information in the accompanying communication). 3 pages.

Pictures of a product manufactured by Häfele (see explanation of relevance and publication date information in the accompanying communication). 3 pages.

Pictures of a product manufactured by Titus Group (see explanation of relevance and publication date information in the accompanying communication). 3 pages.

* cited by examiner

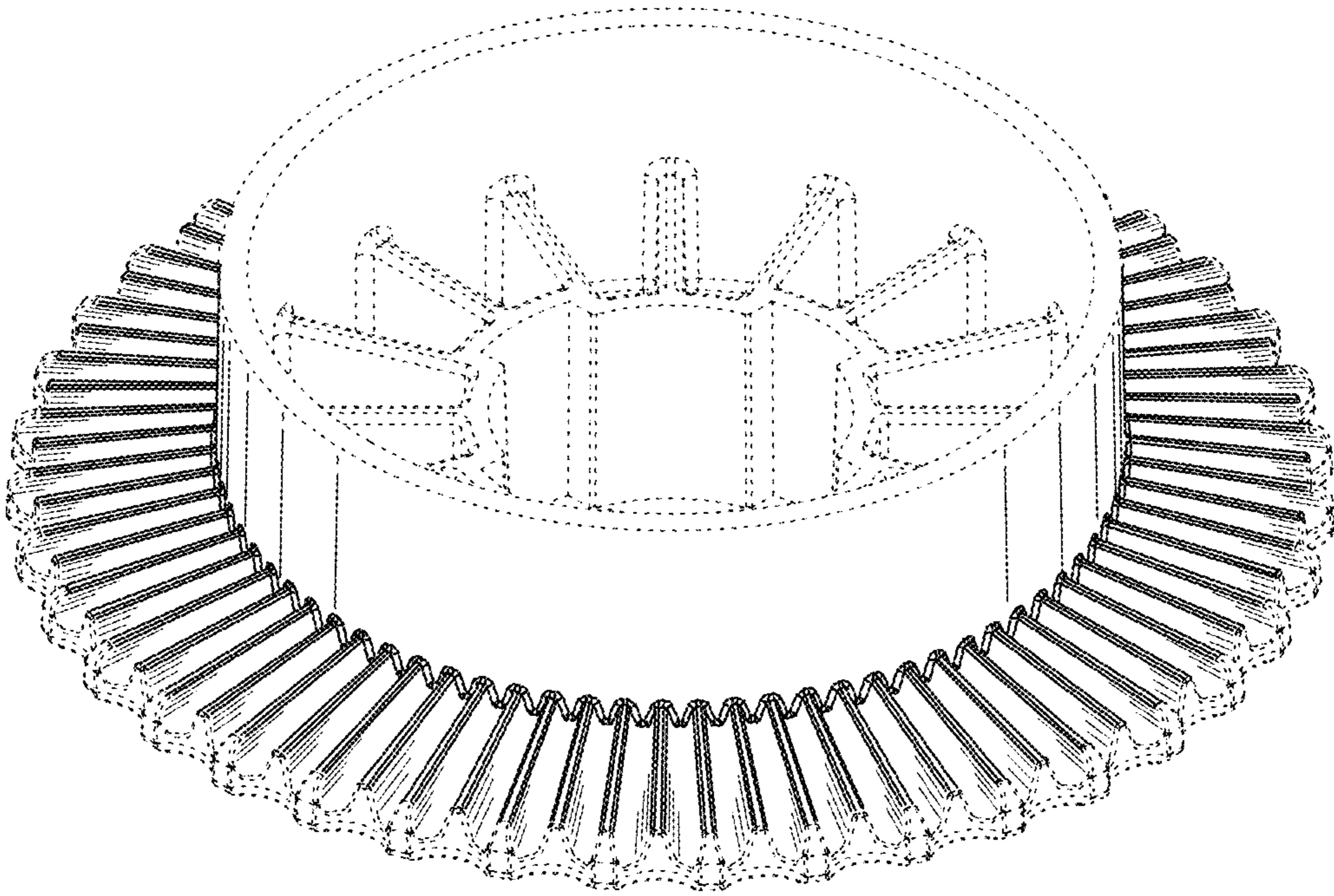

FIG. 1

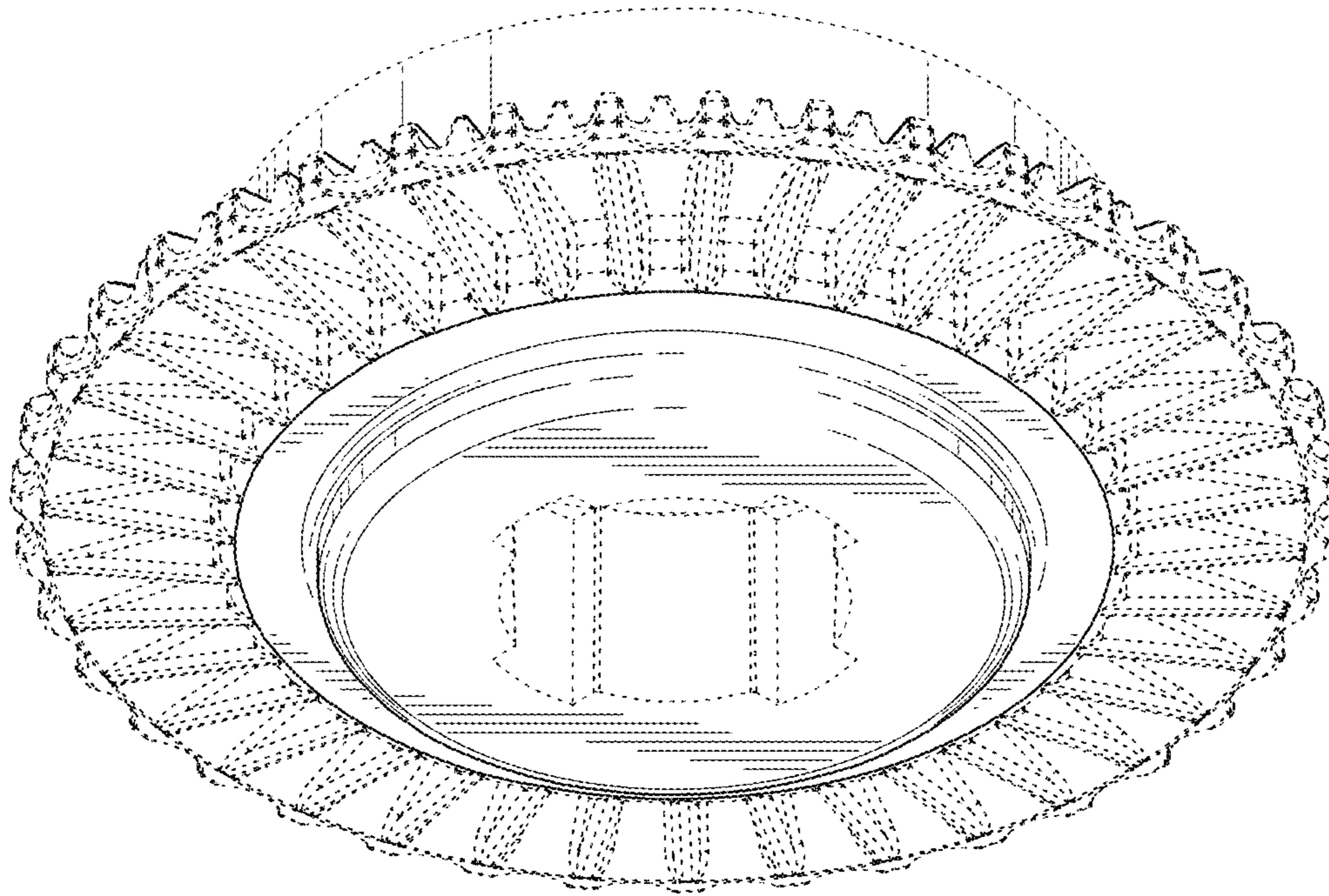

FIG. 2

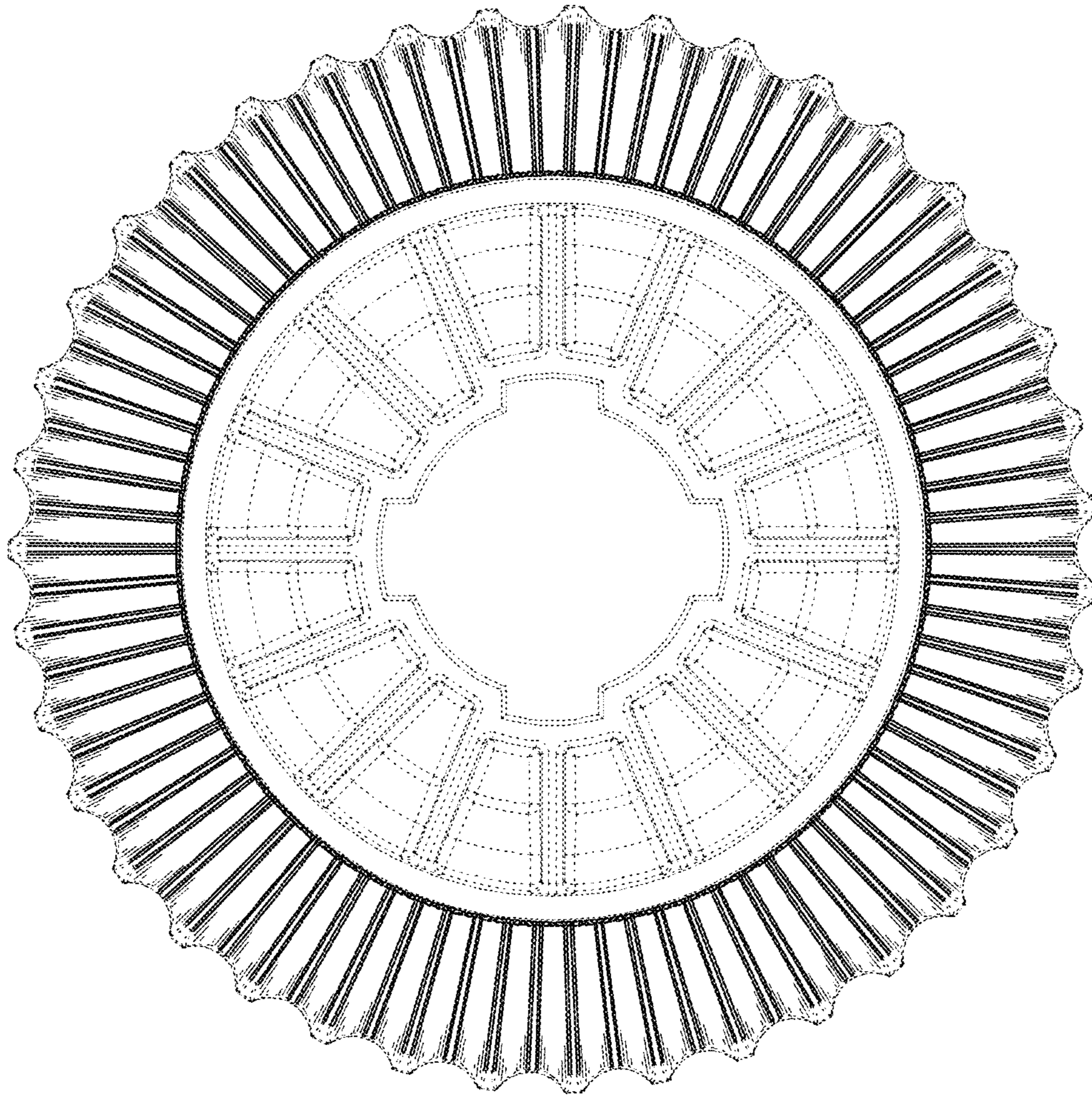

FIG. 3

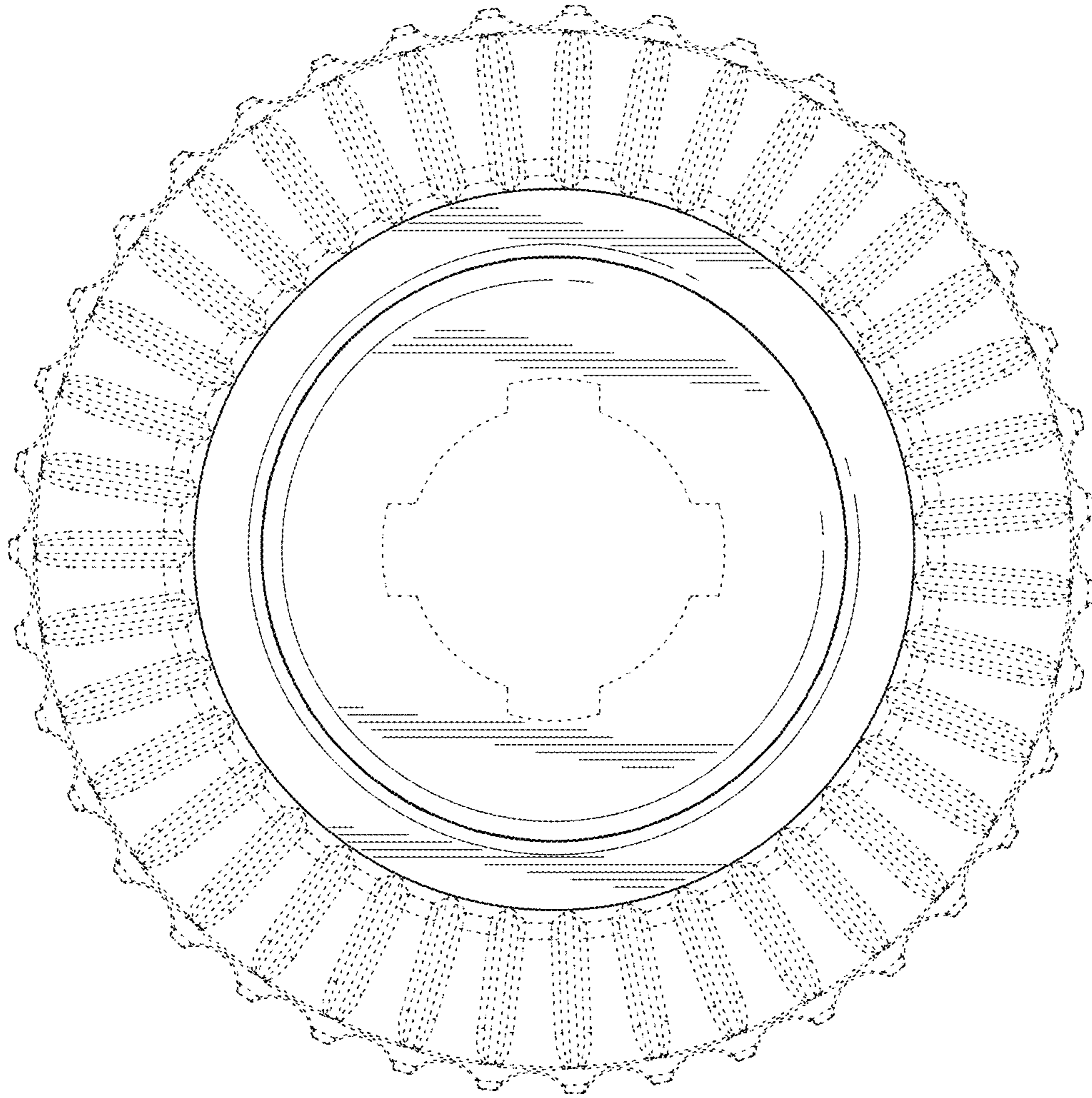

FIG. 4

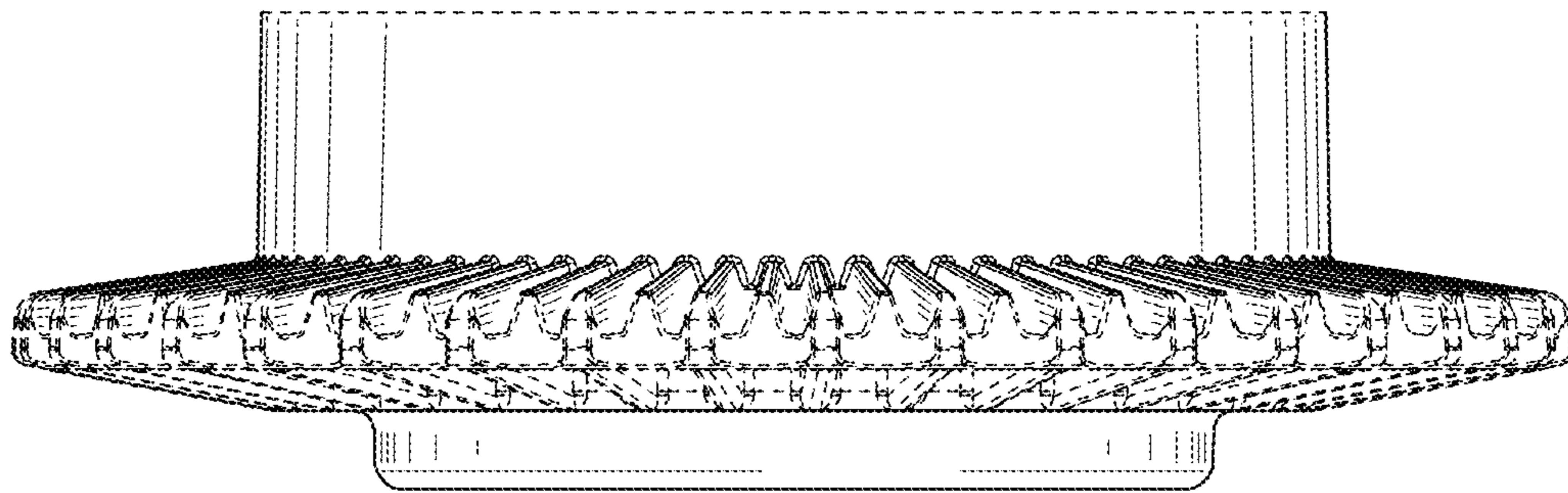

FIG. 5

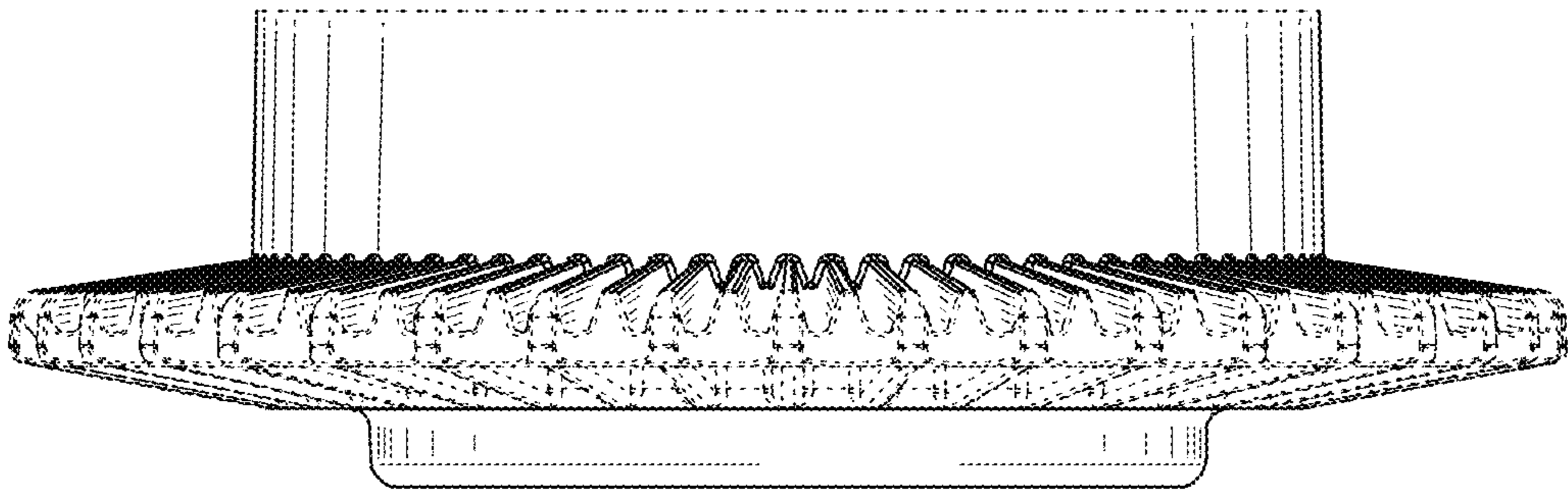

FIG. 6

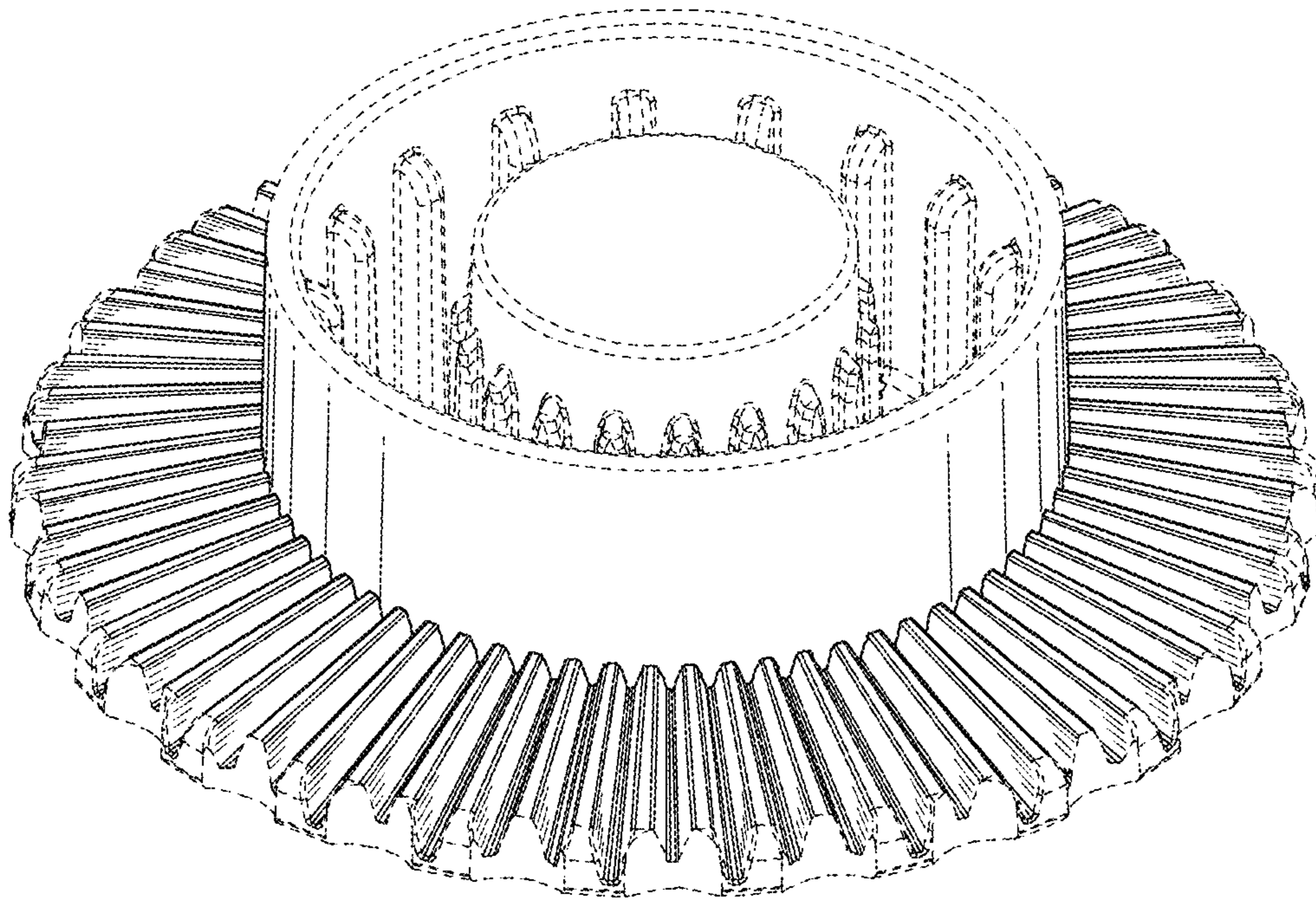

FIG. 7

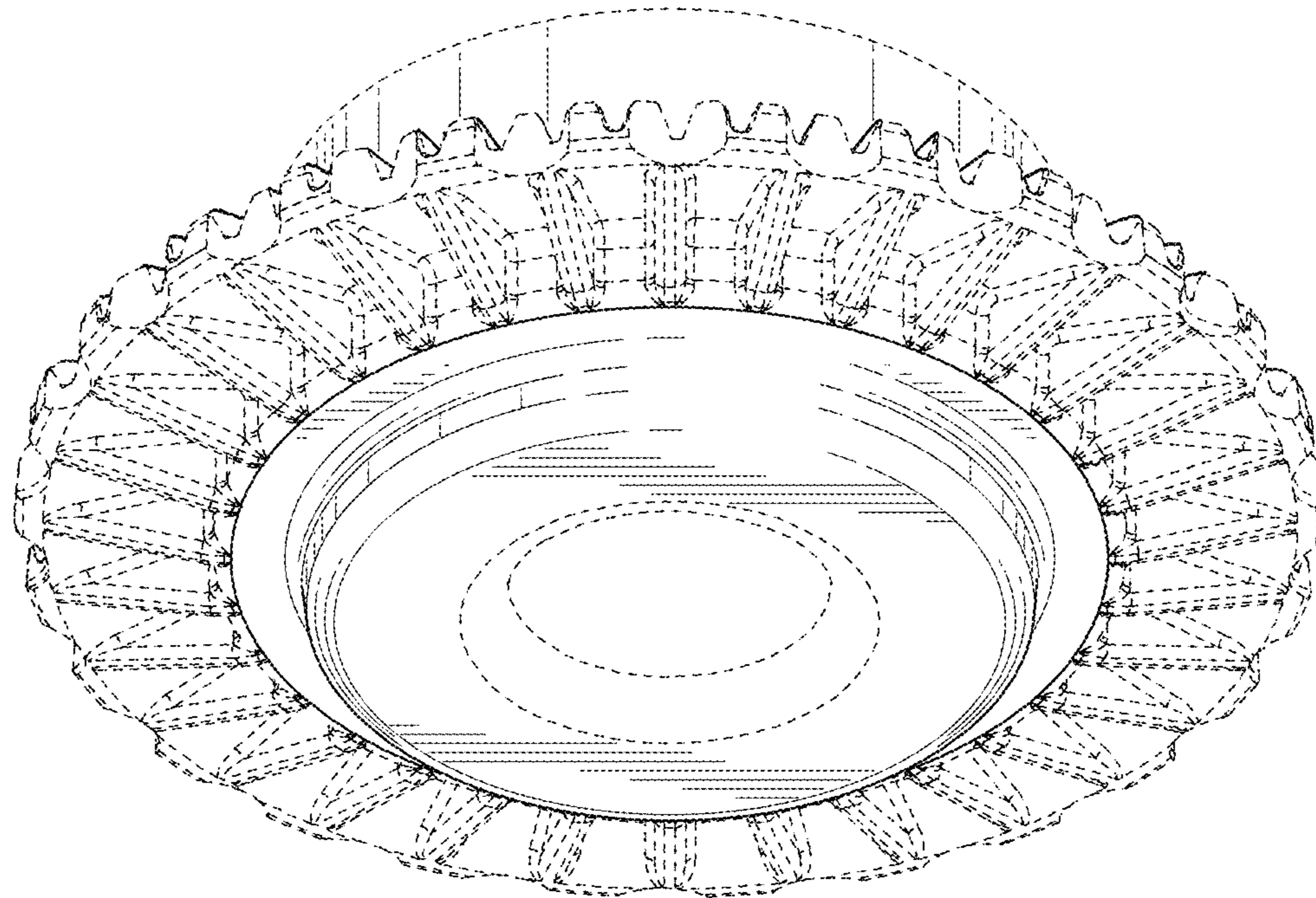

FIG. 8

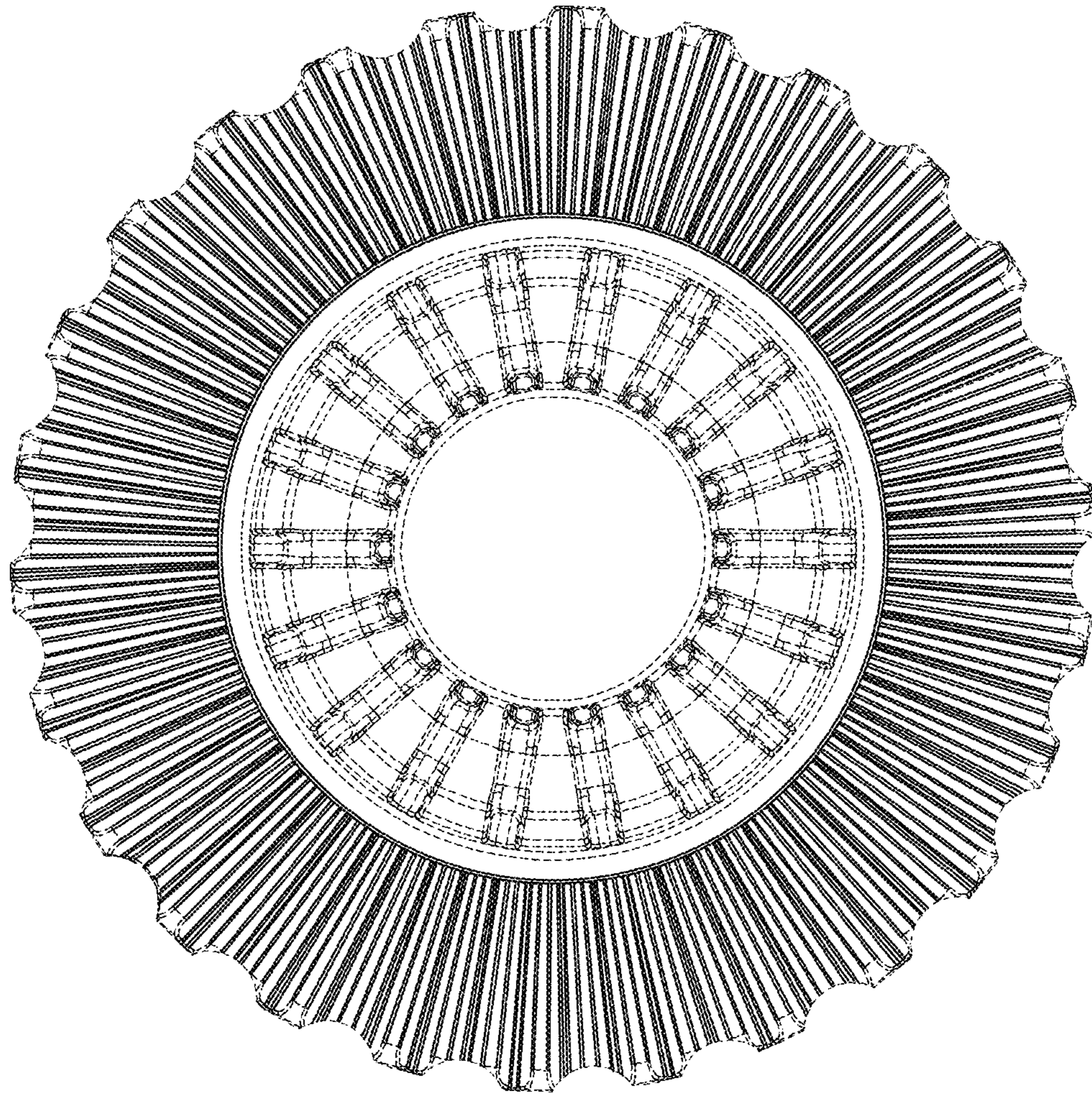

FIG. 9

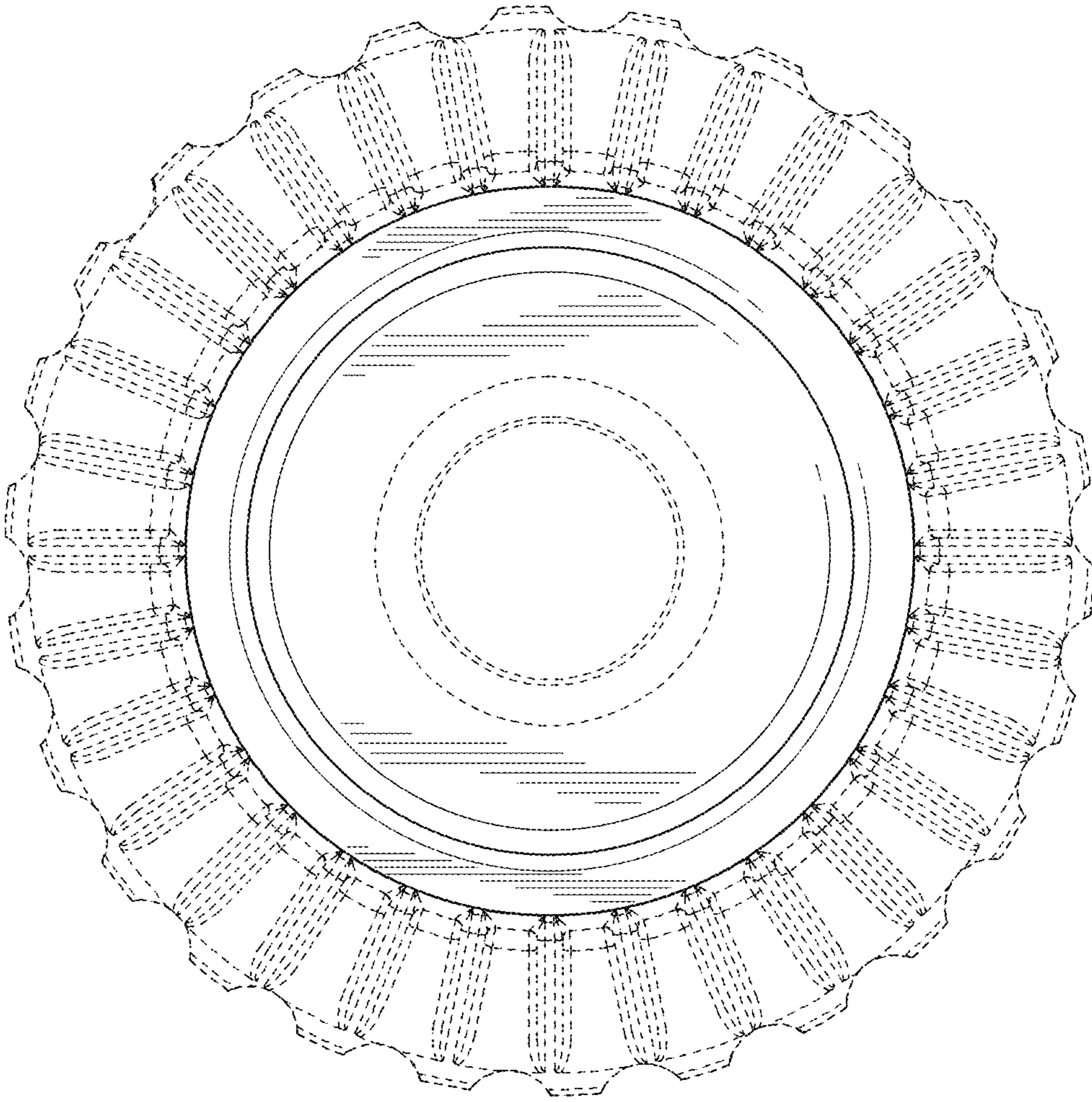

FIG. 10

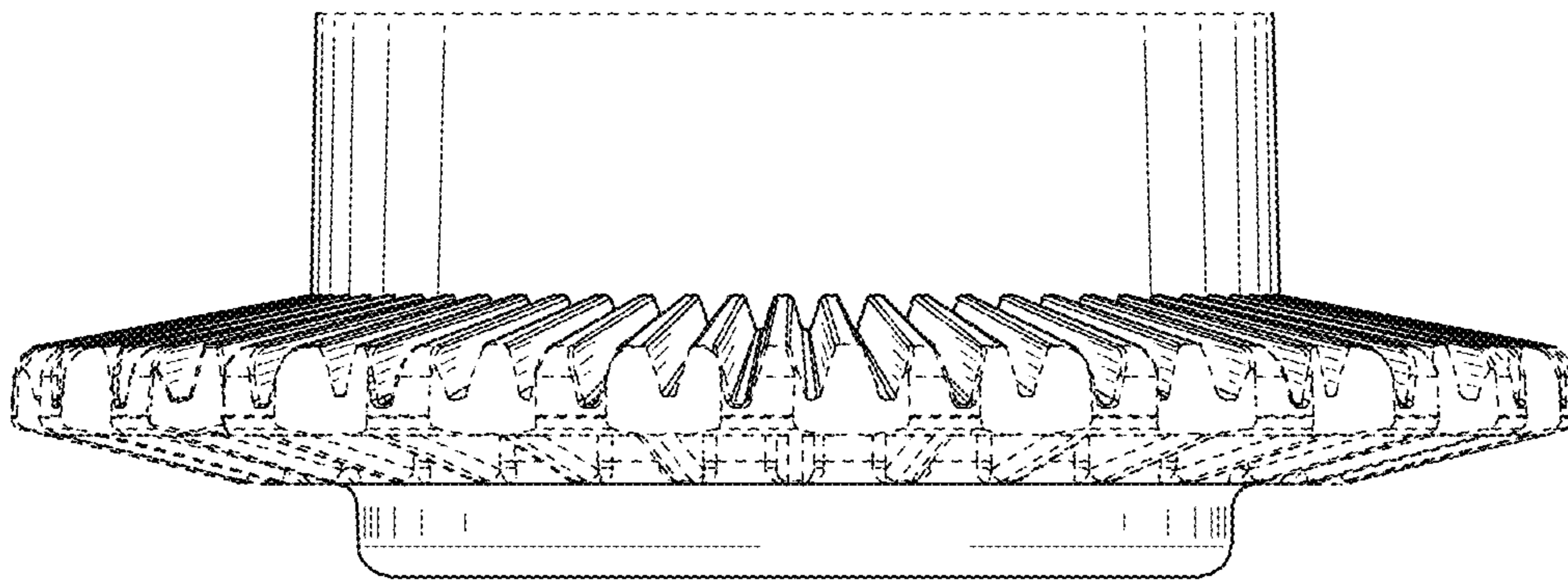

FIG. 11

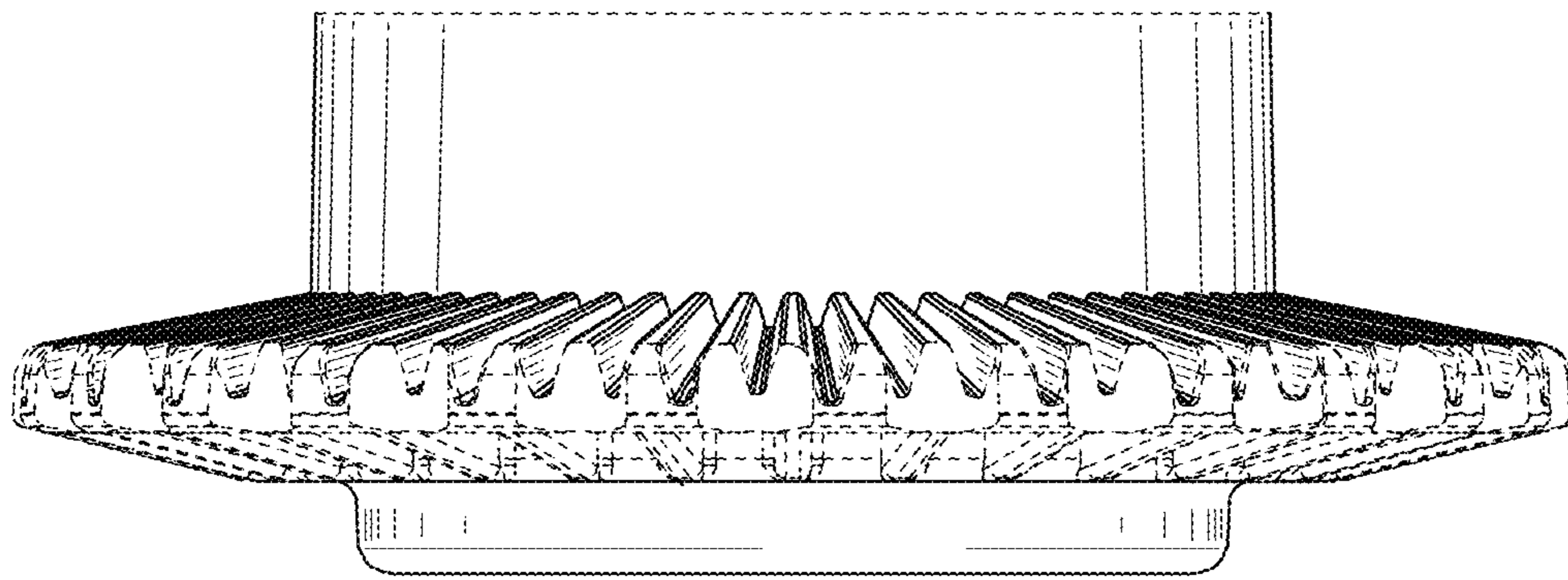

FIG. 12

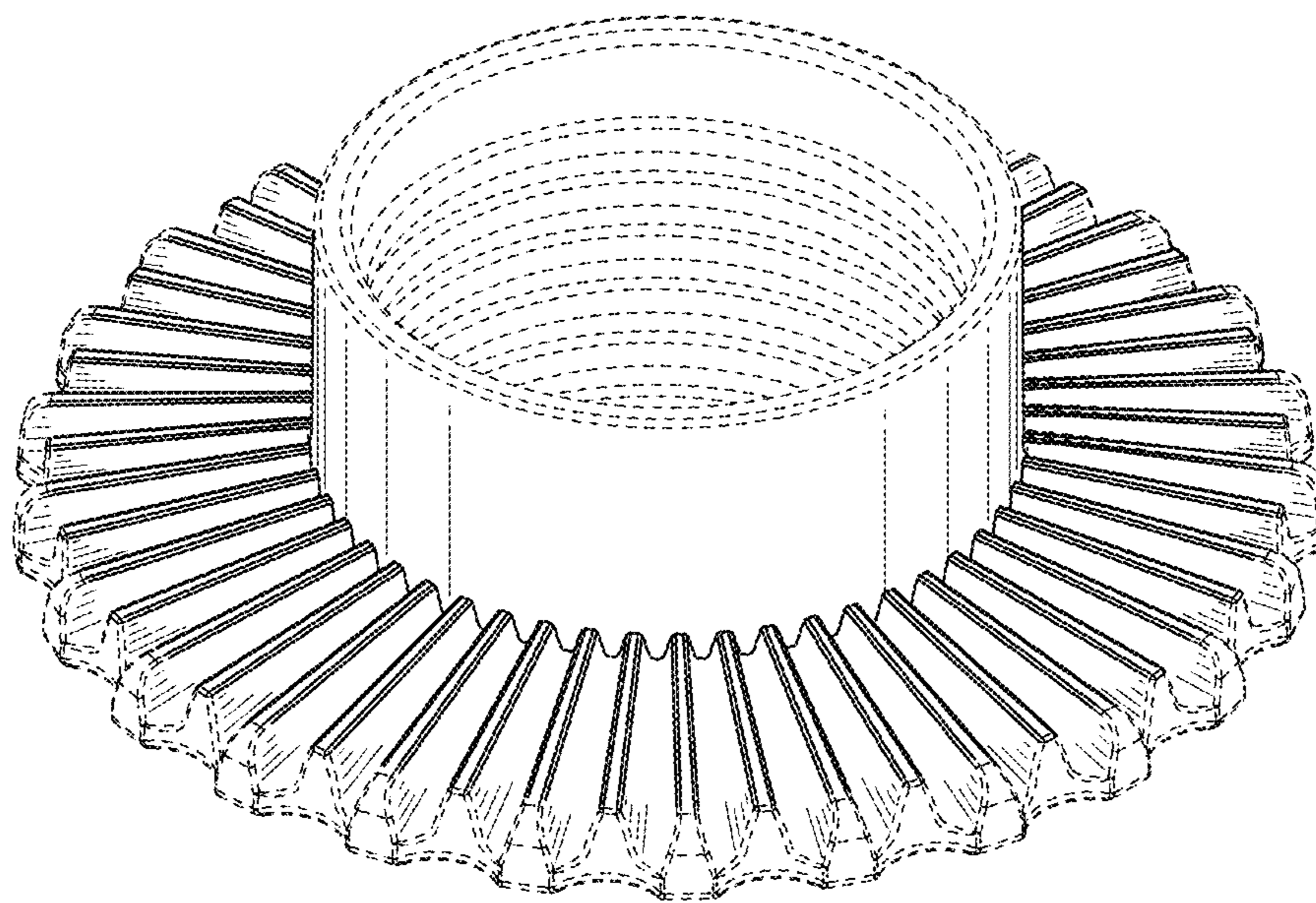

FIG. 13

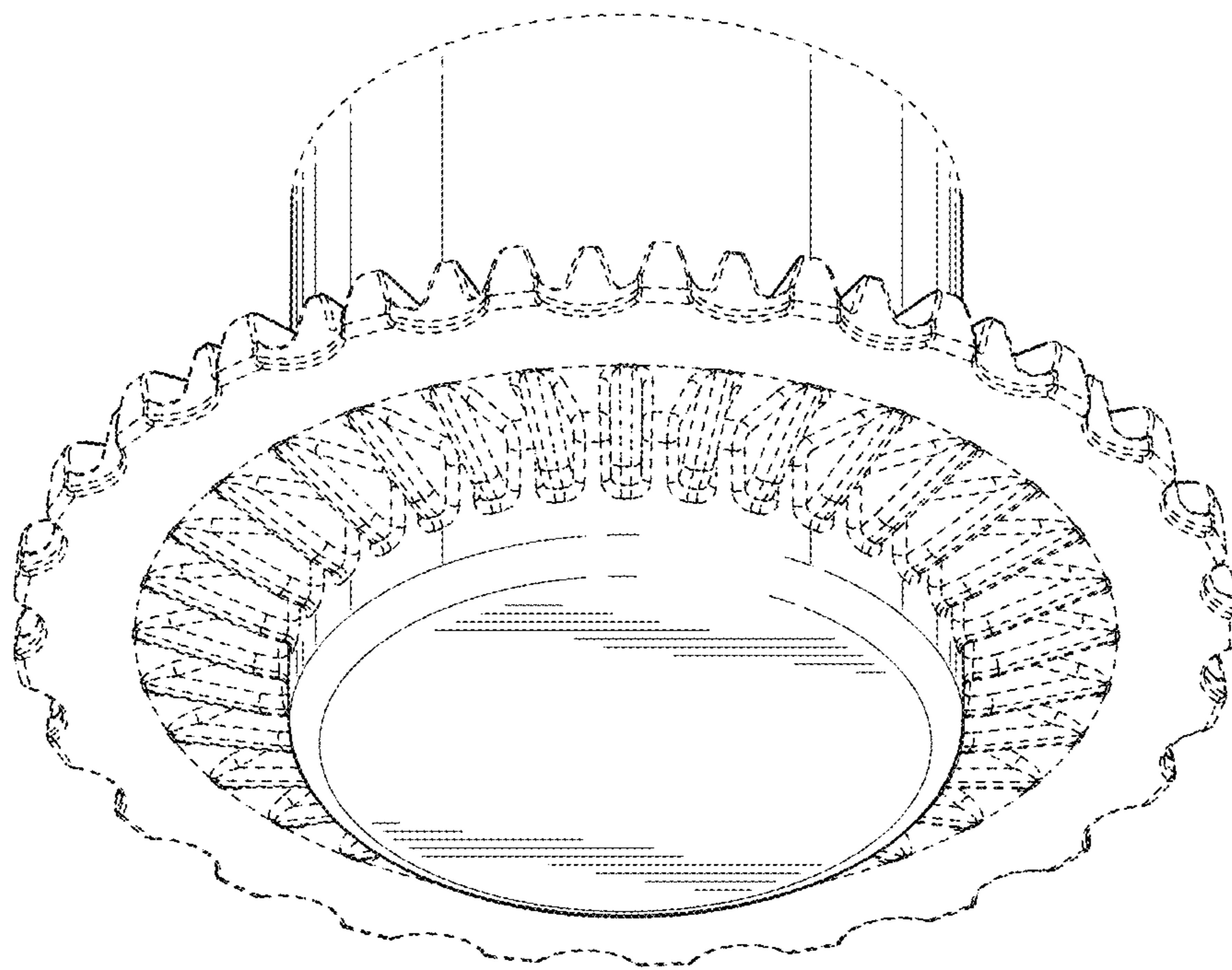

FIG. 14

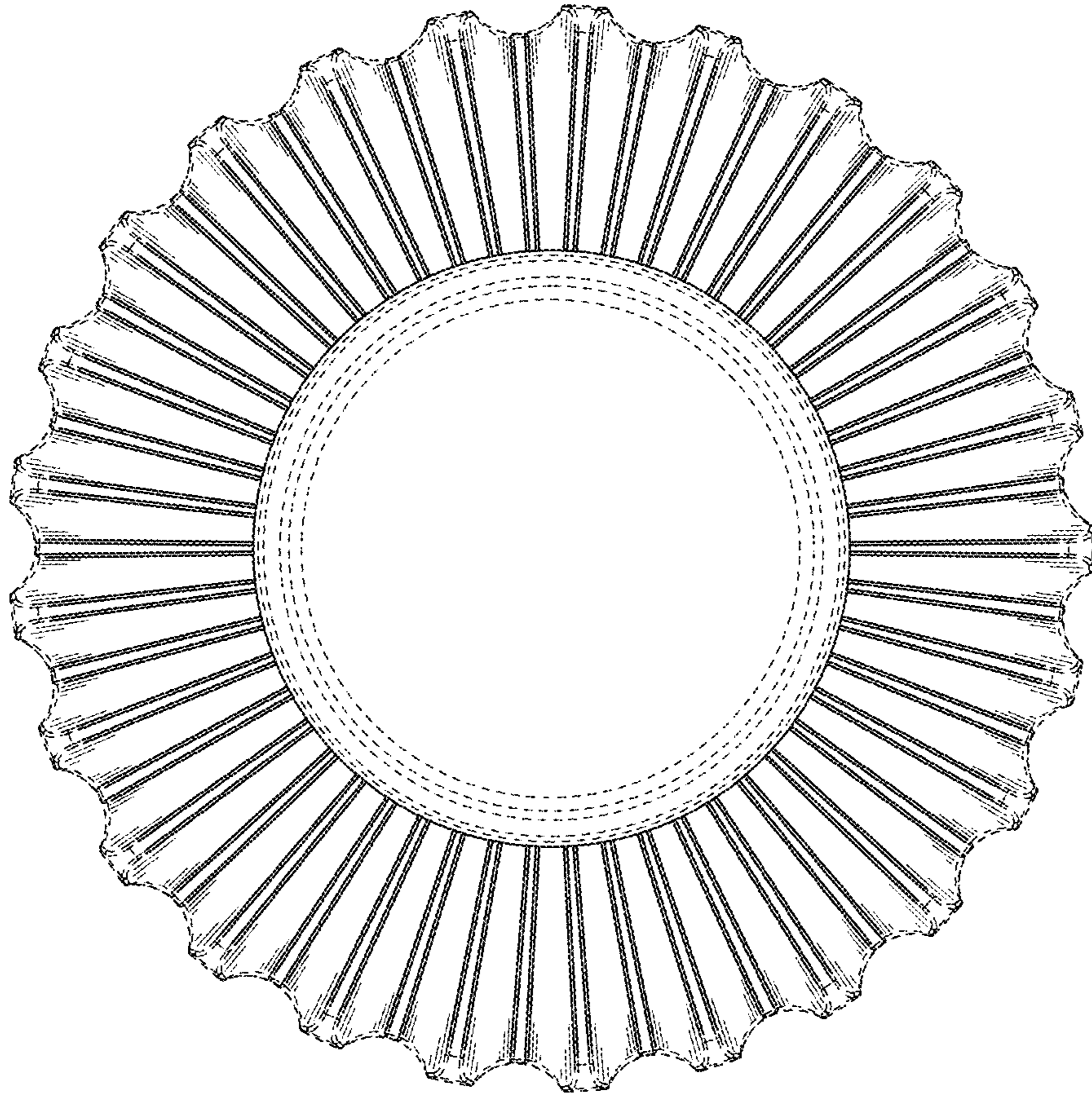

FIG. 15

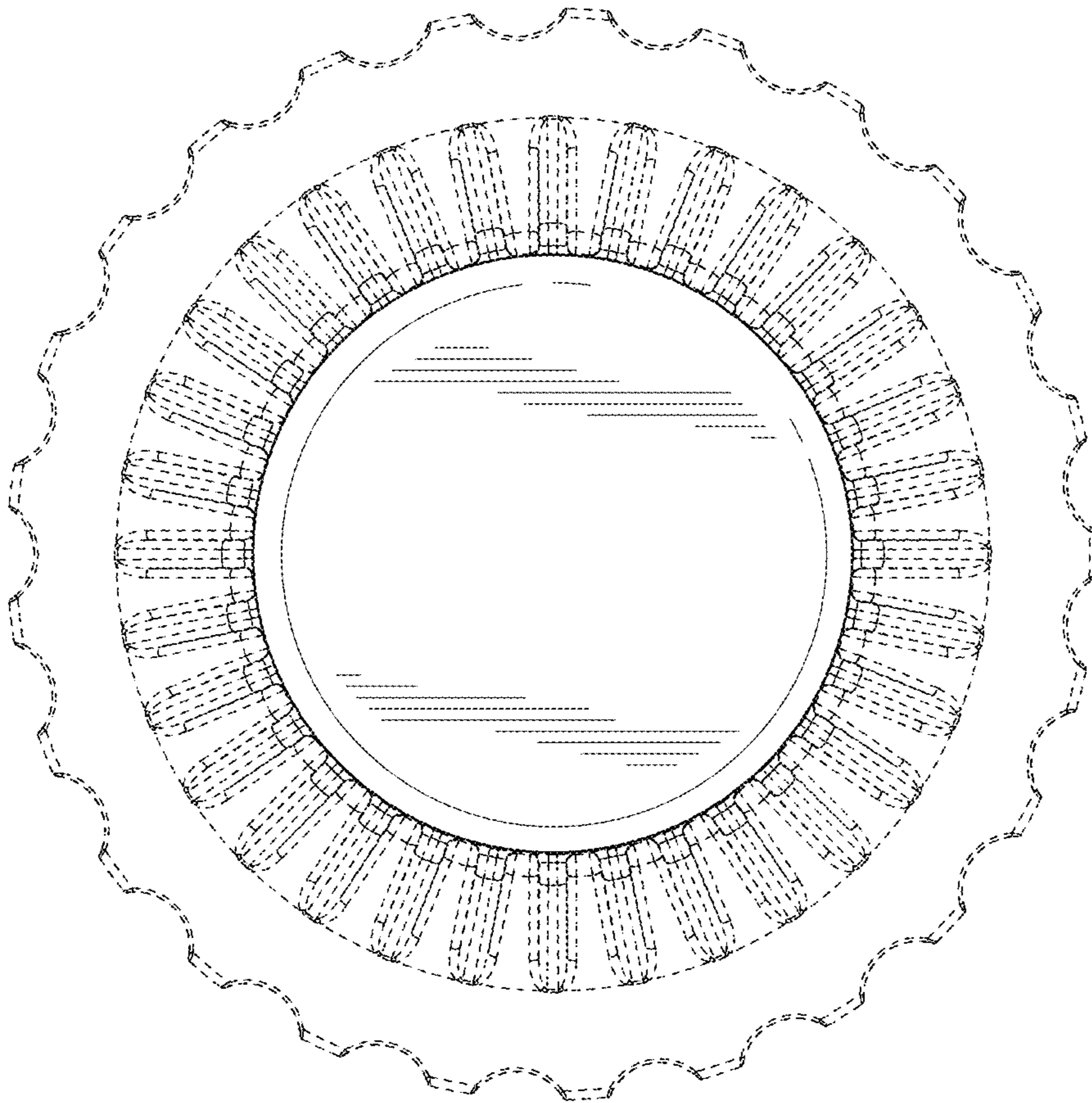

FIG. 16

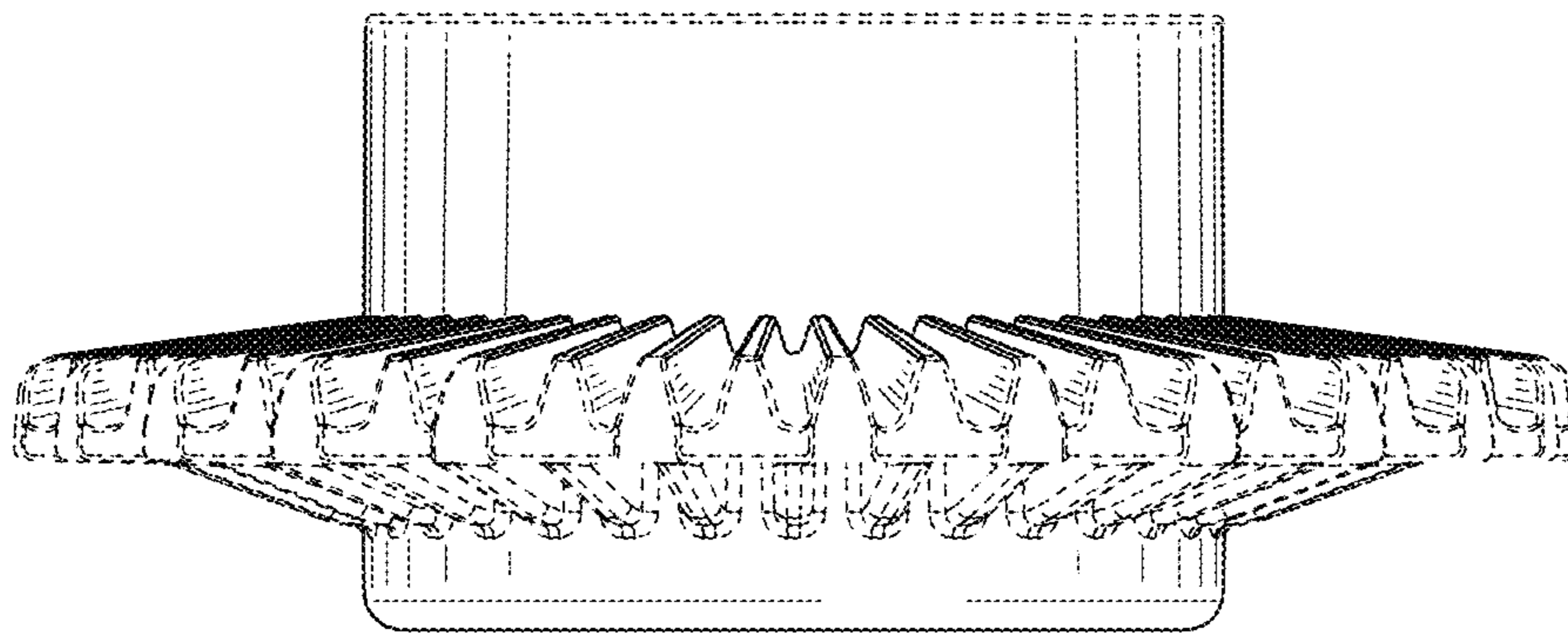

FIG. 17

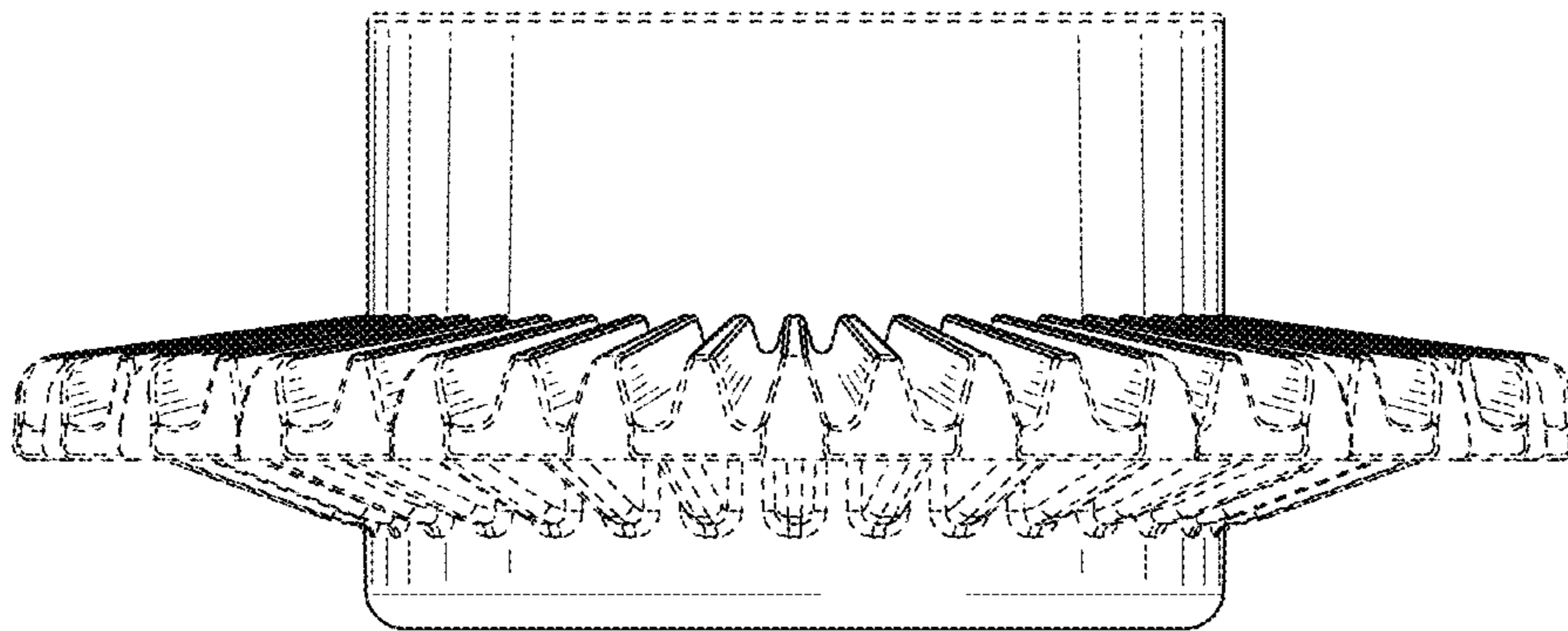

FIG. 18