



US00D796846S

(12) **United States Design Patent**  
**Tang**

(10) **Patent No.:** **US D796,846 S**  
(45) **Date of Patent:** **\*\* Sep. 12, 2017**

(54) **GEAR STRAP**

- (71) Applicant: **Tim C. Tang**, Carson, CA (US)
- (72) Inventor: **Tim C. Tang**, Carson, CA (US)
- (\*\*) Term: **15 Years**
- (21) Appl. No.: **29/569,432**
- (22) Filed: **Jun. 27, 2016**
- (51) **LOC (10) Cl.** ..... **03-01**
- (52) **U.S. Cl.**  
USPC ..... **D3/327**
- (58) **Field of Classification Search**  
USPC ..... D3/327  
CPC ..... A45F 5/10; A45F 3/04; A63B 55/00  
See application file for complete search history.

(56) **References Cited**

U.S. PATENT DOCUMENTS

- D216,075 S \* 11/1969 D'Elia et al. .... D2/627
- D359,836 S \* 7/1995 Shuler ..... D29/101.5
- D532,201 S \* 11/2006 Esch ..... A45F 3/14  
D3/327
- D770,776 S \* 11/2016 Hannon ..... D3/327

\* cited by examiner

*Primary Examiner* — Holly H Baynham

(74) *Attorney, Agent, or Firm* — Edwin Tarver

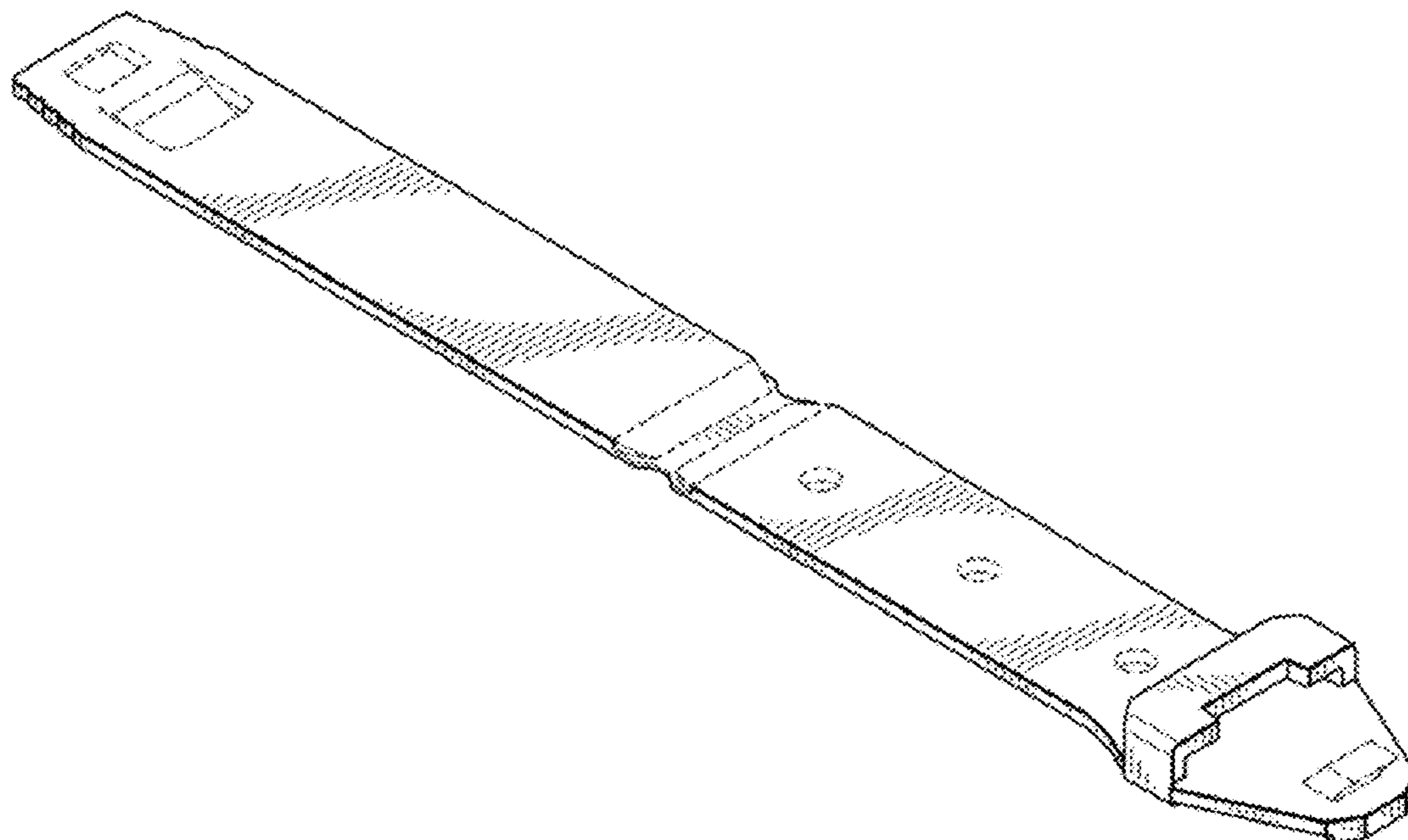
(57) **CLAIM**

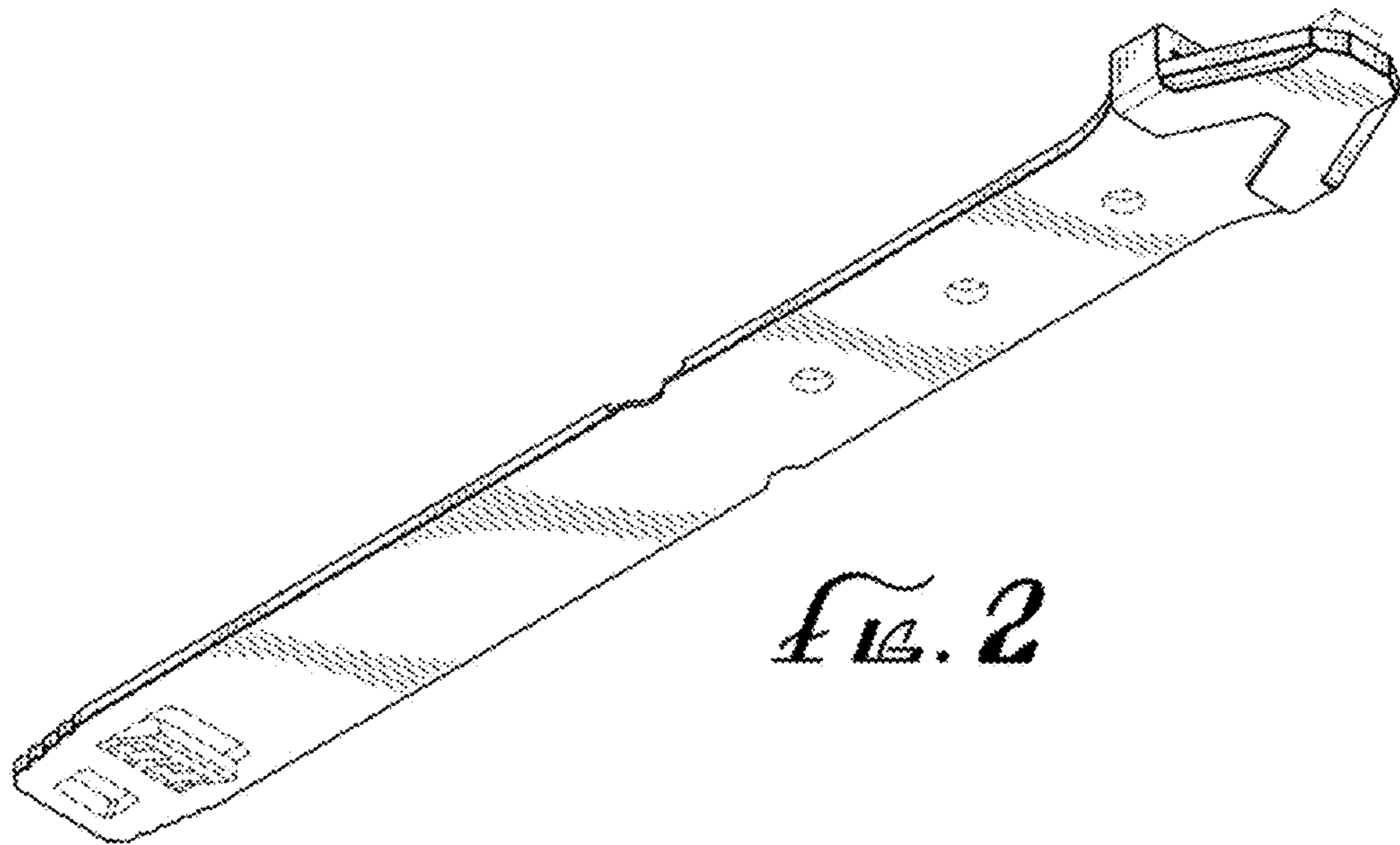
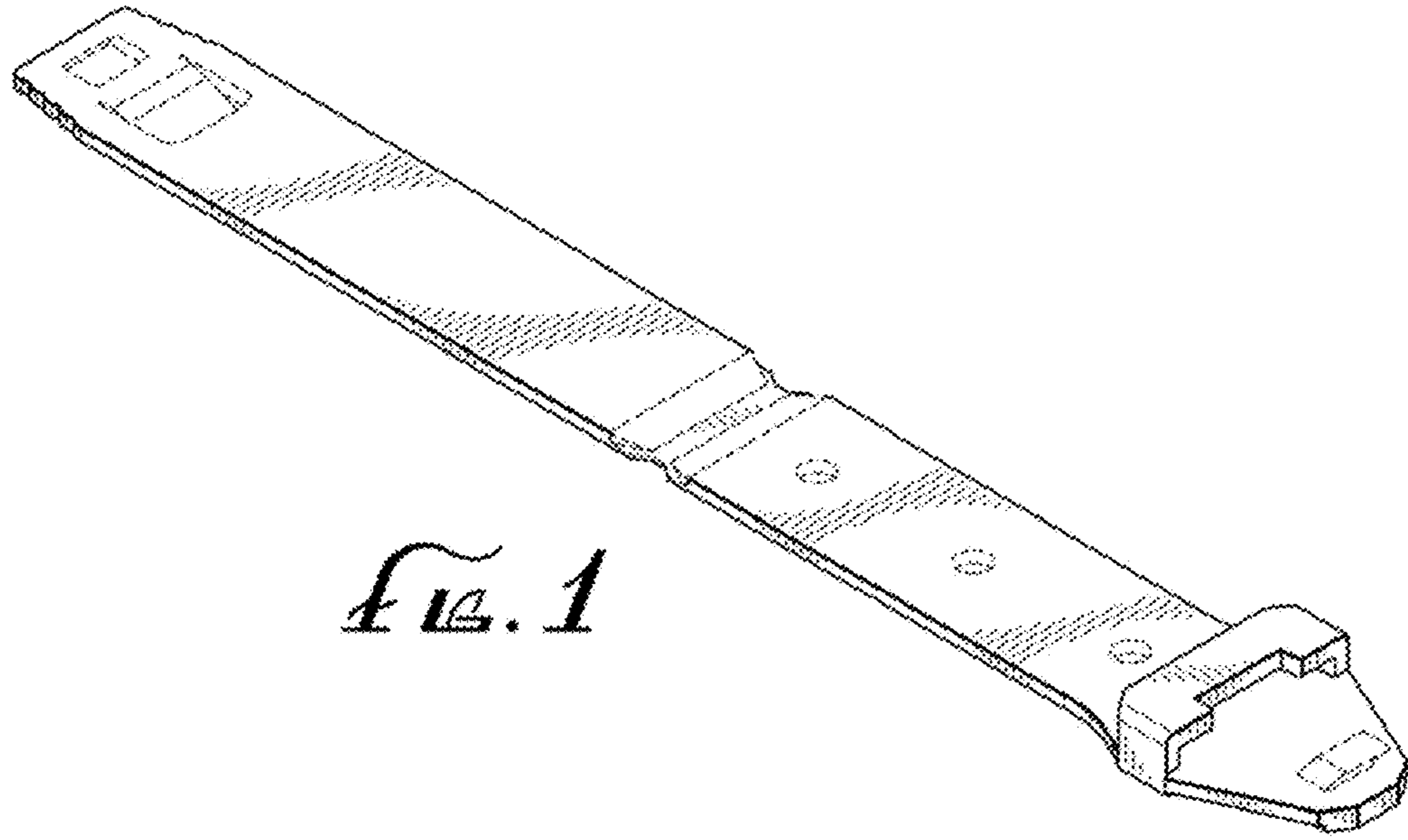
I claim the ornamental design for a gear strap, as shown and described.

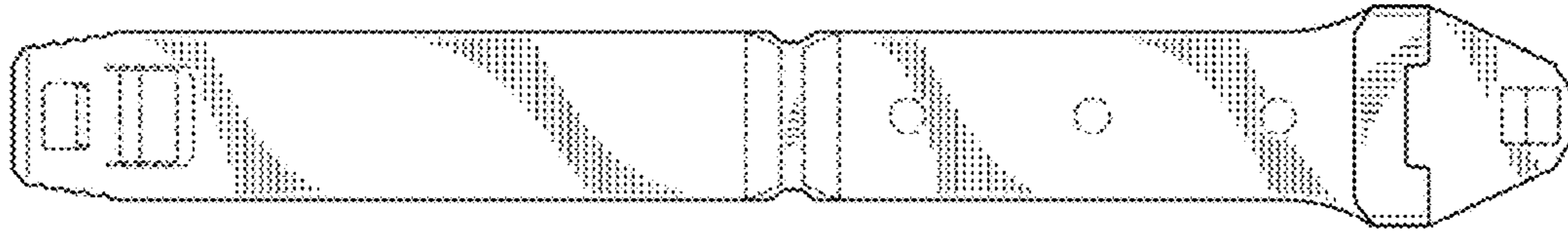
**DESCRIPTION**

FIG. 1 is a top perspective view of a first embodiment gear strap;  
 FIG. 2 is a bottom perspective view the first embodiment gear strap;  
 FIG. 3 is a top plan view of the first embodiment gear strap;  
 FIG. 4 is a bottom plan view of the first embodiment gear strap;  
 FIG. 5 is a left side elevational view of the first embodiment gear strap;  
 FIG. 6 is a rear elevational view of the first embodiment gear strap;  
 FIG. 7 is a front elevational view of the first embodiment gear strap;  
 FIG. 8 is a top perspective view of a second embodiment gear strap;  
 FIG. 9 is a bottom perspective view of the second embodiment gear strap;  
 FIG. 10 is a top plan view of the second embodiment gear strap;  
 FIG. 11 is a bottom plan view of the second embodiment gear strap;  
 FIG. 12 is a left side elevational view of the second embodiment gear strap;  
 FIG. 13 is a rear elevational view of the second embodiment gear strap; and,  
 FIG. 14 is a front elevational view of the second embodiment gear strap.  
 The broken lines shown in the drawings are for the purposes of illustrating environment and form no part of the claimed design.

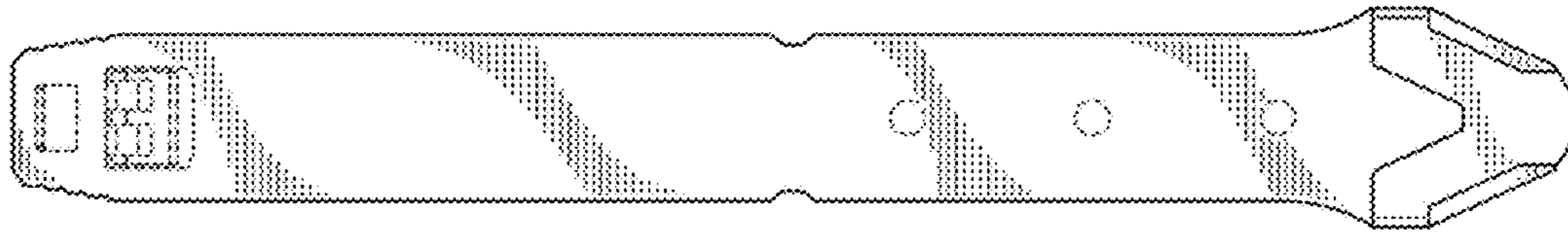
**1 Claim, 5 Drawing Sheets**



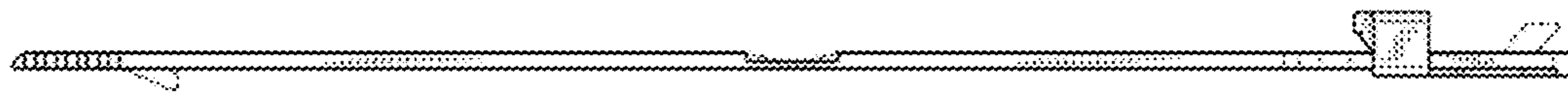




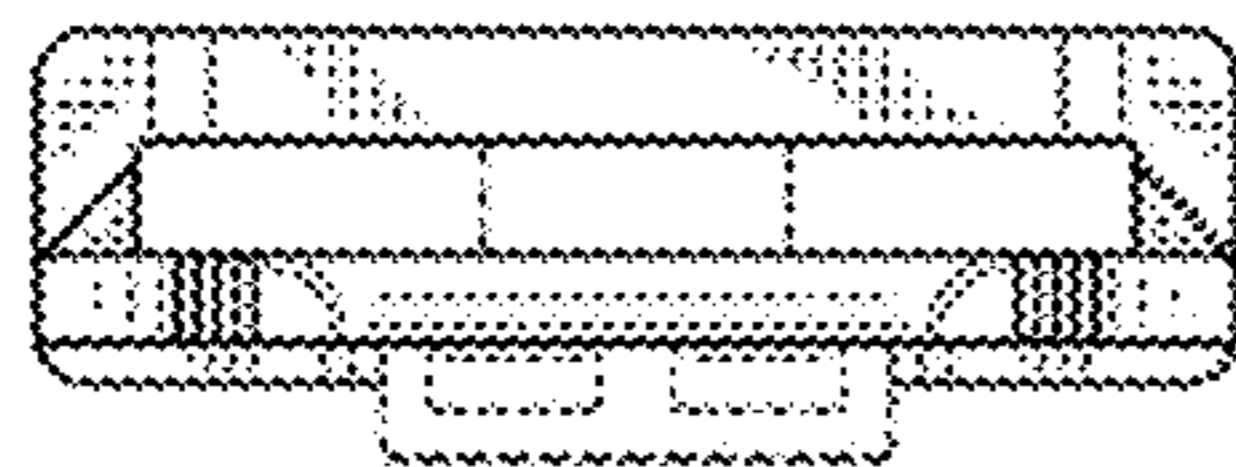
*Fig. 3*



*Fig. 4*



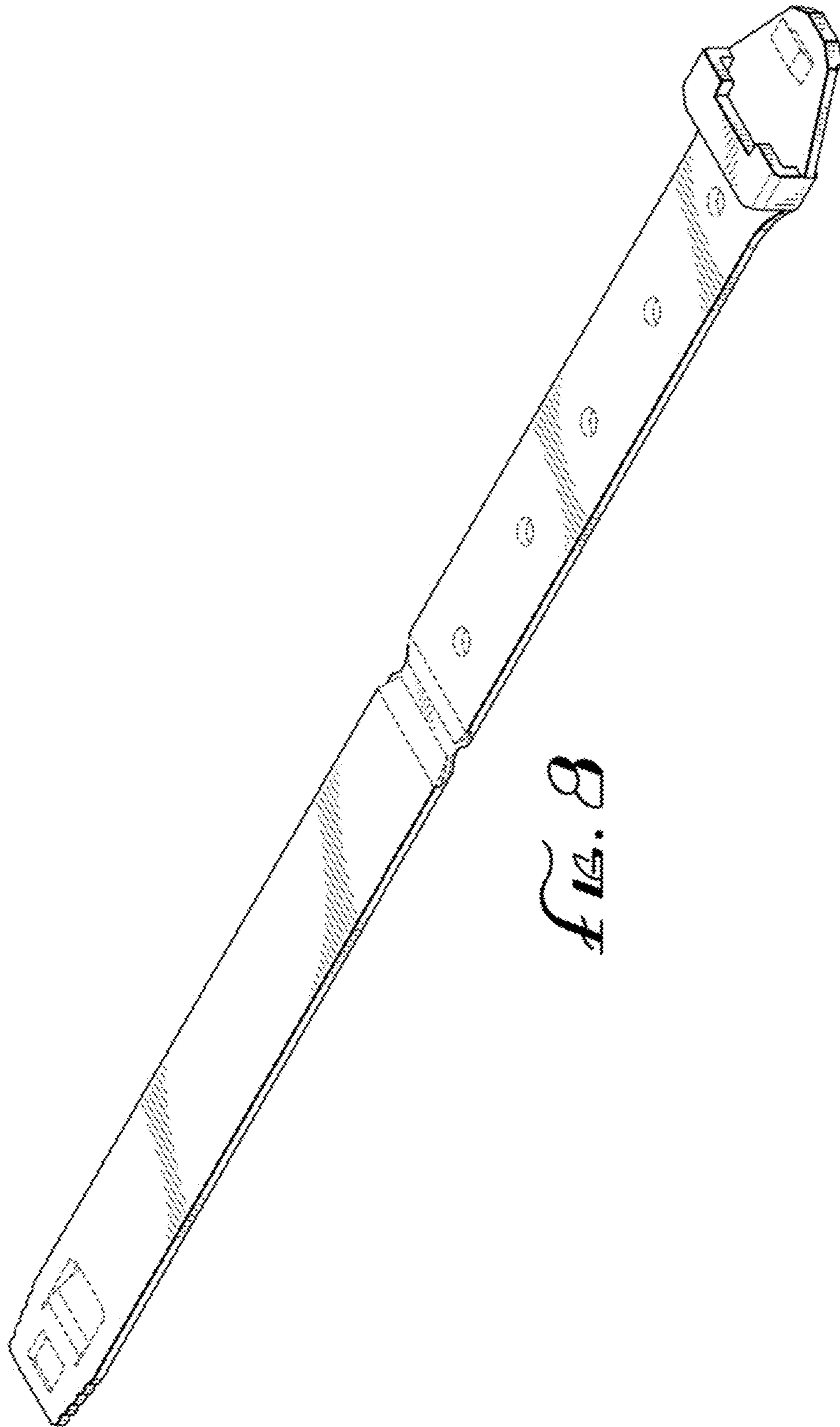
*Fig. 5*

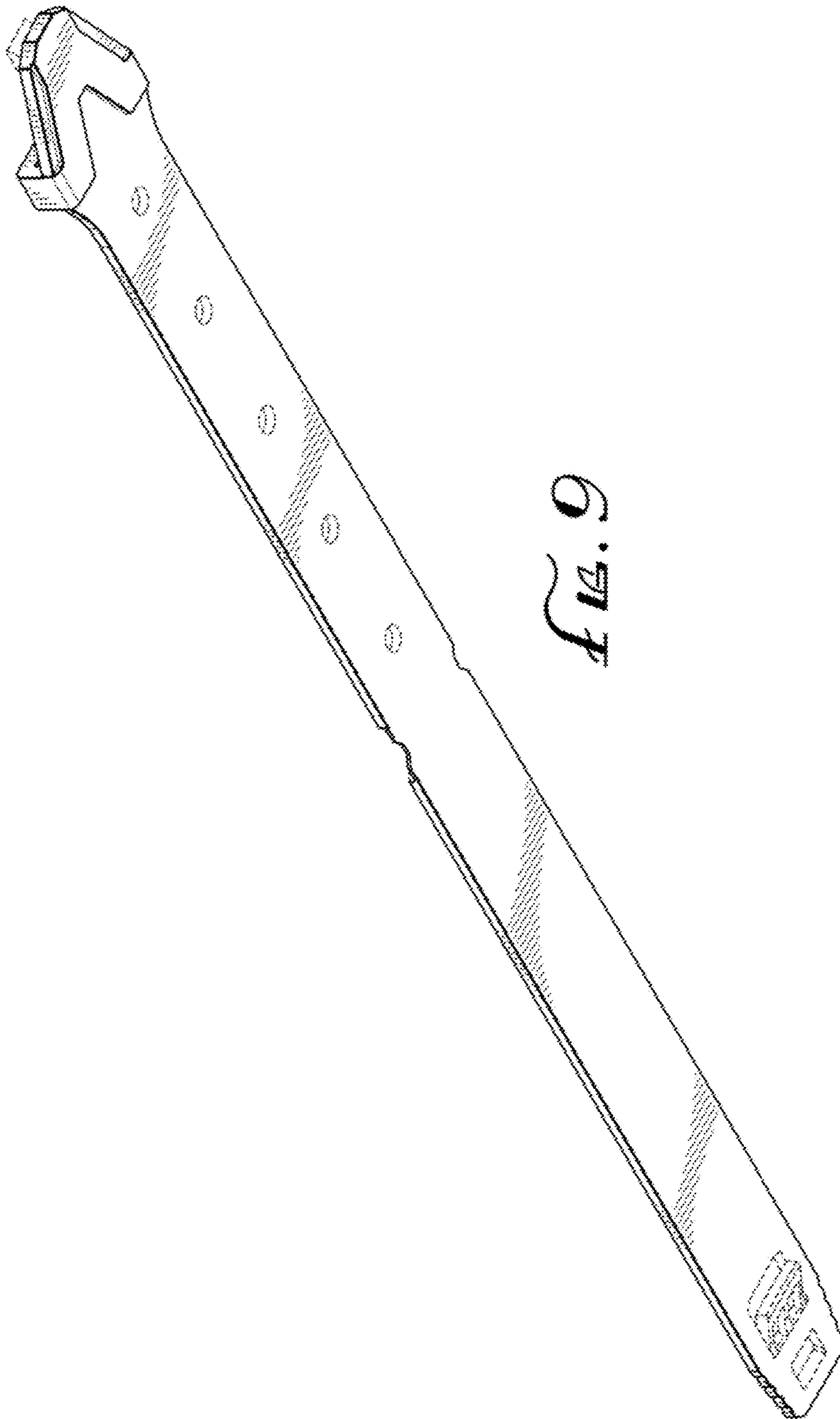


*Fig. 6*



*Fig. 7*





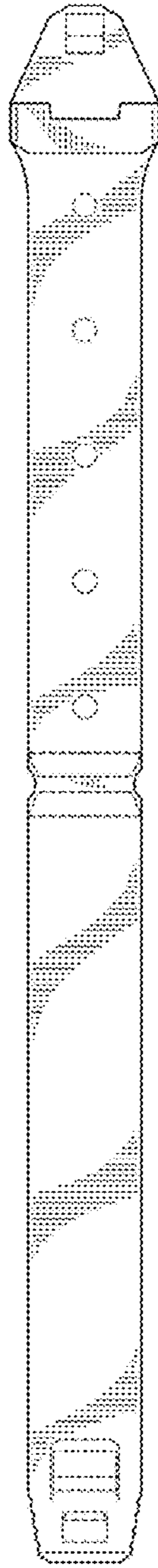


FIG. 10

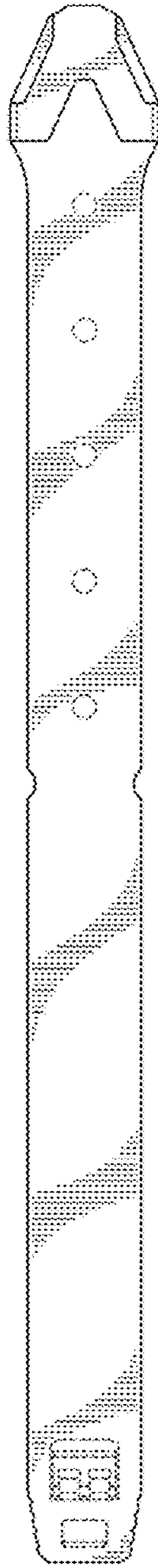


FIG. 11

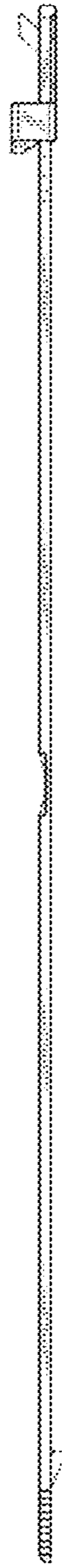


FIG. 12

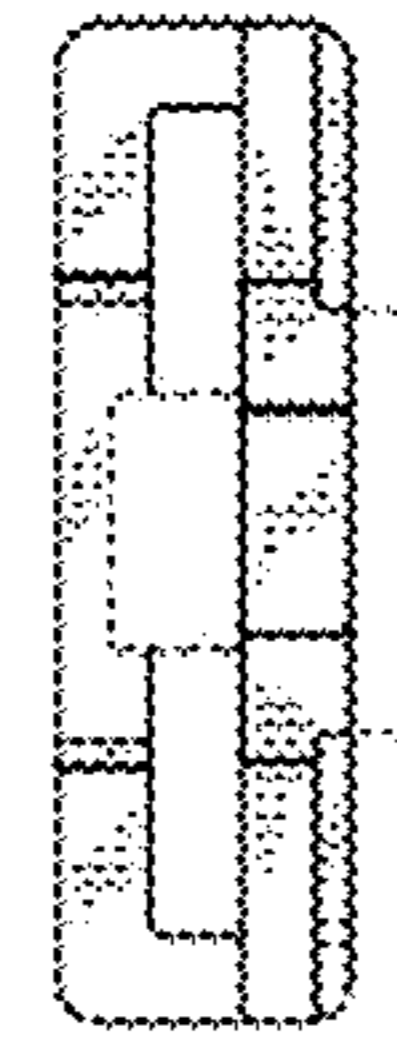


FIG. 13

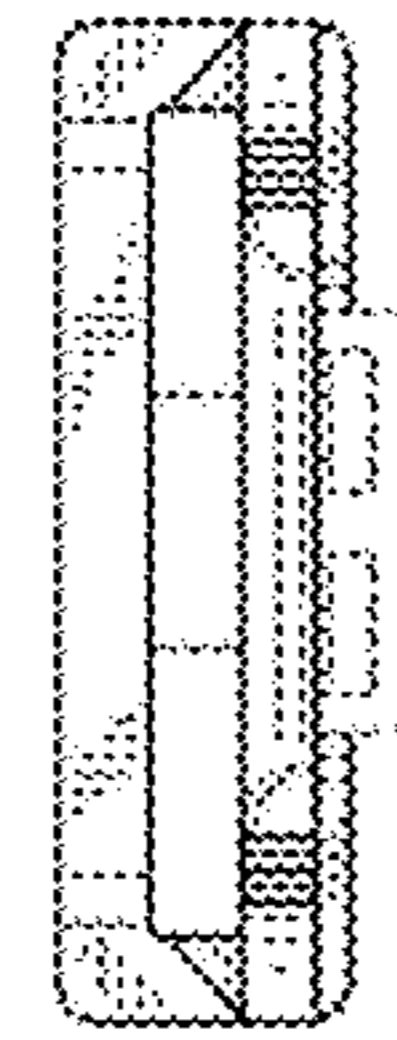


FIG. 14