



US00D796782S

(12) **United States Design Patent** (10) **Patent No.:** **US D796,782 S**
Mozafari (45) **Date of Patent:** **** Sep. 12, 2017**

- (54) **GARMENT**
- (71) Applicant: **NIKE, Inc.**, Beaverton, OR (US)
- (72) Inventor: **Niloufar Mozafari**, Portland, OR (US)
- (73) Assignee: **NIKE, Inc.**, Beaverton, OR (US)
- (**) Term: **15 Years**
- (21) Appl. No.: **29/557,492**
- (22) Filed: **Mar. 9, 2016**
- (51) **LOC (10) Cl.** **02-02**
- (52) **U.S. Cl.**
USPC **D2/731**
- (58) **Field of Classification Search**
USPC D2/840, 841, 829, 731, 853, 708
CPC A41D 1/00
See application file for complete search history.

D715,029 S *	10/2014	Roberts	D2/840
D733,397 S *	7/2015	Harps	D2/731
D758,692 S *	6/2016	Burlo	D2/731
D760,479 S *	7/2016	Adrovic	D2/731
D760,480 S *	7/2016	Adrovic	D2/731
D761,521 S *	7/2016	McArthur	D2/731
D763,550 S *	8/2016	Martz	D2/749
2006/0053526 A1 *	3/2006	Beland	A41D 13/0015 2/115
2008/0184454 A1 *	8/2008	Collier	A41D 1/06 2/93
2009/0192433 A1 *	7/2009	Wells	A41D 13/1245 602/77

* cited by examiner

Primary Examiner — Kevin Rudzinski
(74) *Attorney, Agent, or Firm* — Banner & Witcoff, Ltd.

(57) **CLAIM**

The ornamental design for a garment, as shown and described.

DESCRIPTION

FIG. 1 is a front perspective view of a garment showing our new design;

FIG. 2 is a front view thereof;

FIG. 3 is a rear view thereof;

FIG. 4 is a side view thereof;

FIG. 5 is a second side view thereof;

FIG. 6 is a top view thereof; and,

FIG. 7 is a bottom view thereof.

The broken lines immediately adjacent to the shaded area represent unclaimed boundaries of the design. The unshaded regions demarcated by broken lines, represent portions of the garment and form no part of the claimed design.

1 Claim, 5 Drawing Sheets

(56) **References Cited**

U.S. PATENT DOCUMENTS

2,491,001 A *	12/1949	Croonborg	A41D 1/02 2/125
D295,575 S *	5/1988	Campbell	2/115
D391,740 S *	3/1998	Barrington	D2/728
D529,687 S *	10/2006	Rindle	D2/828
D622,938 S *	9/2010	Kanada	D2/840
D639,023 S *	6/2011	Iamartino	D2/750
D641,138 S *	7/2011	Santo	D2/840
8,341,766 B2 *	1/2013	Rodriguez	A41D 3/00 2/93
D679,072 S *	4/2013	Abbevik	D2/828
D698,123 S *	1/2014	Yu	D2/840
D698,524 S *	2/2014	Roberts	D2/839
D703,922 S *	5/2014	Roberts	D2/829

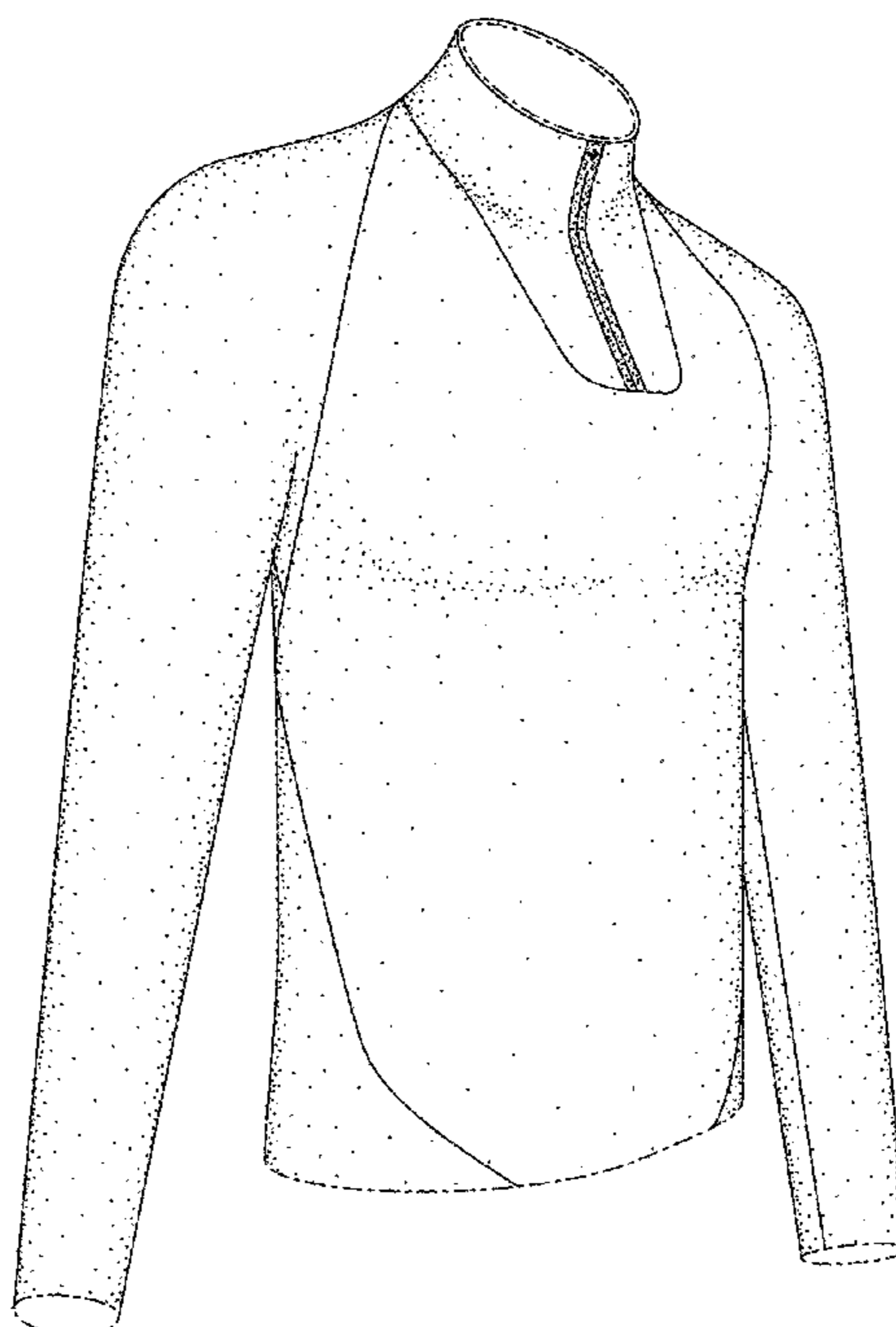

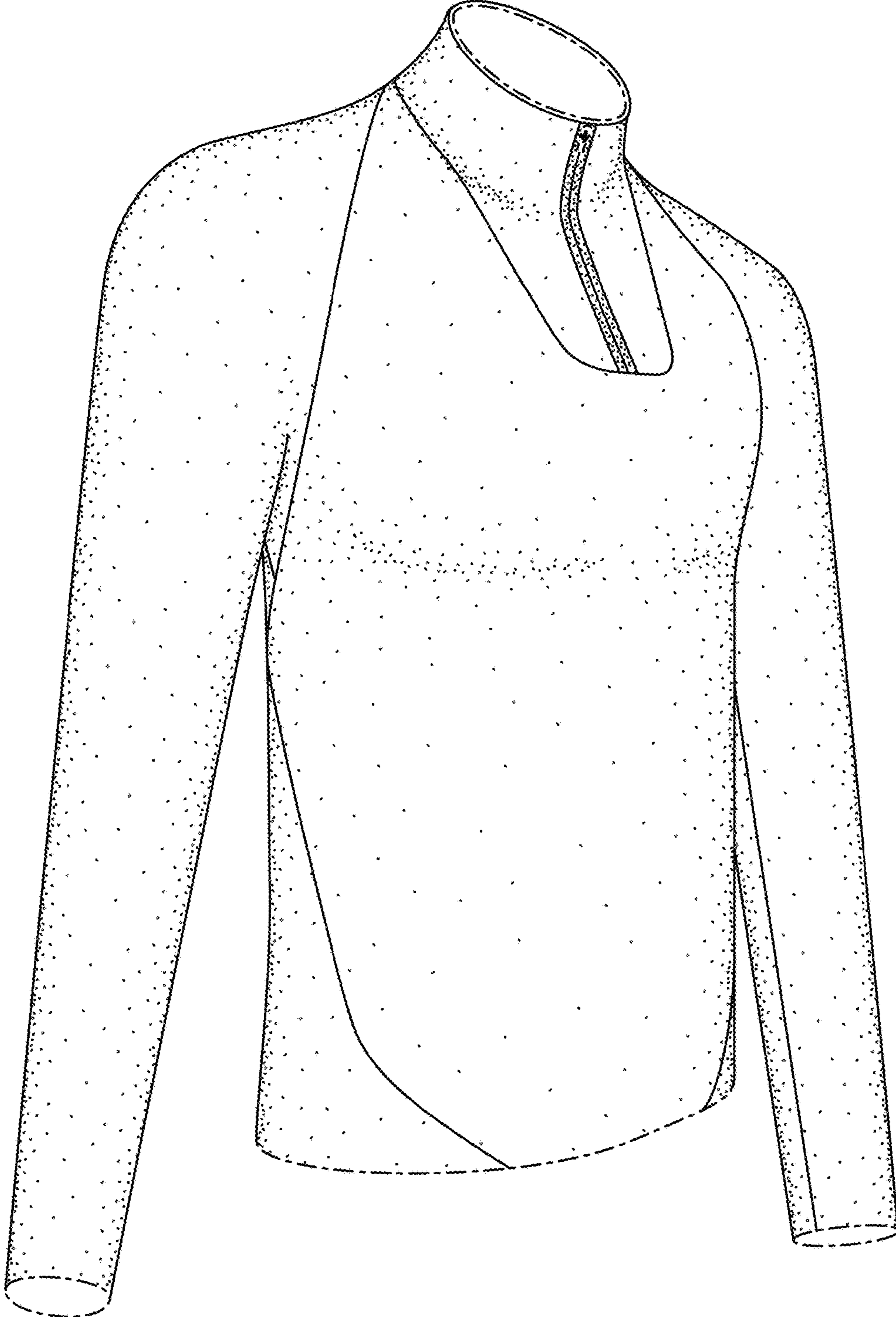

FIG. 1

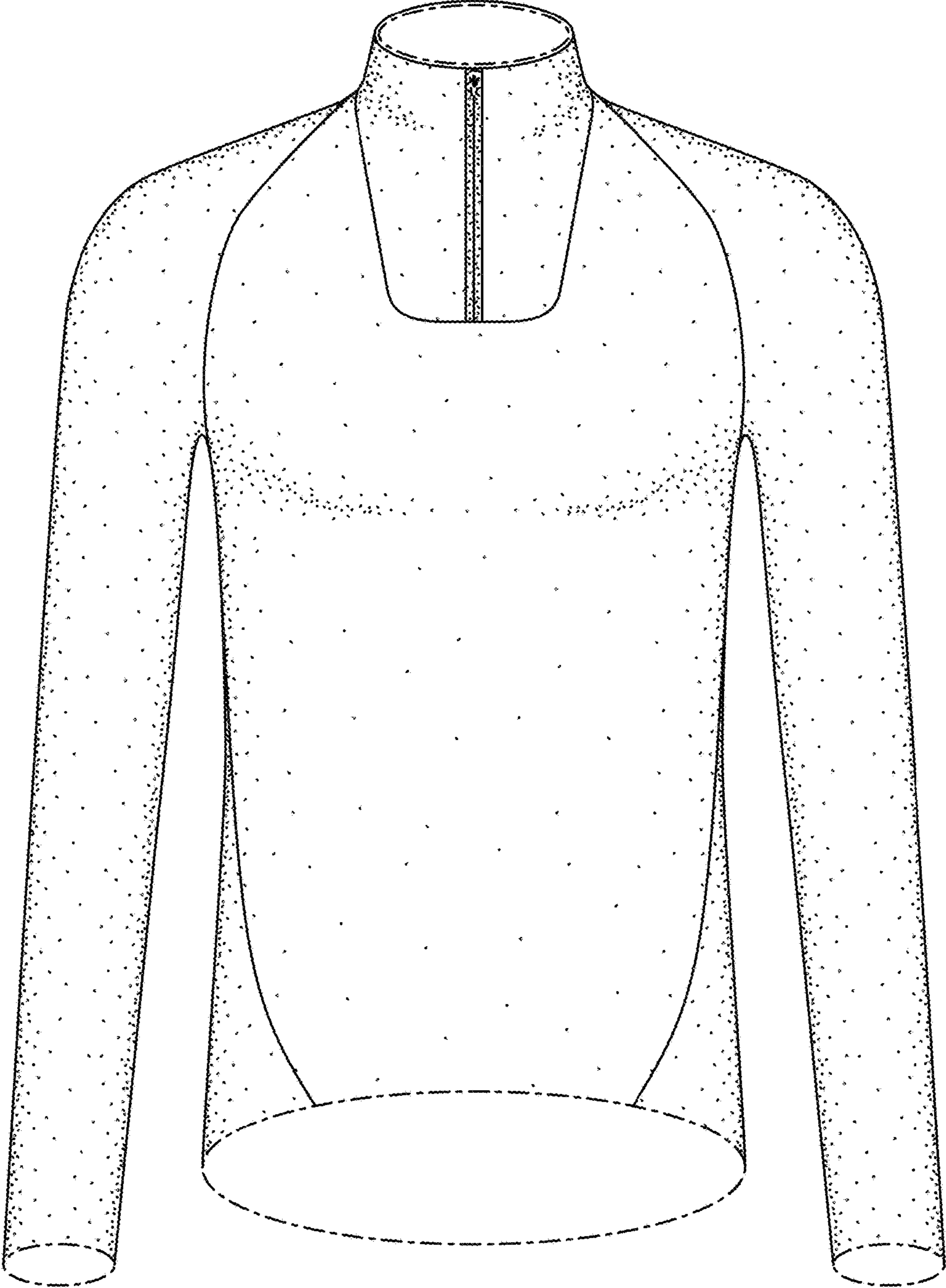

FIG. 2

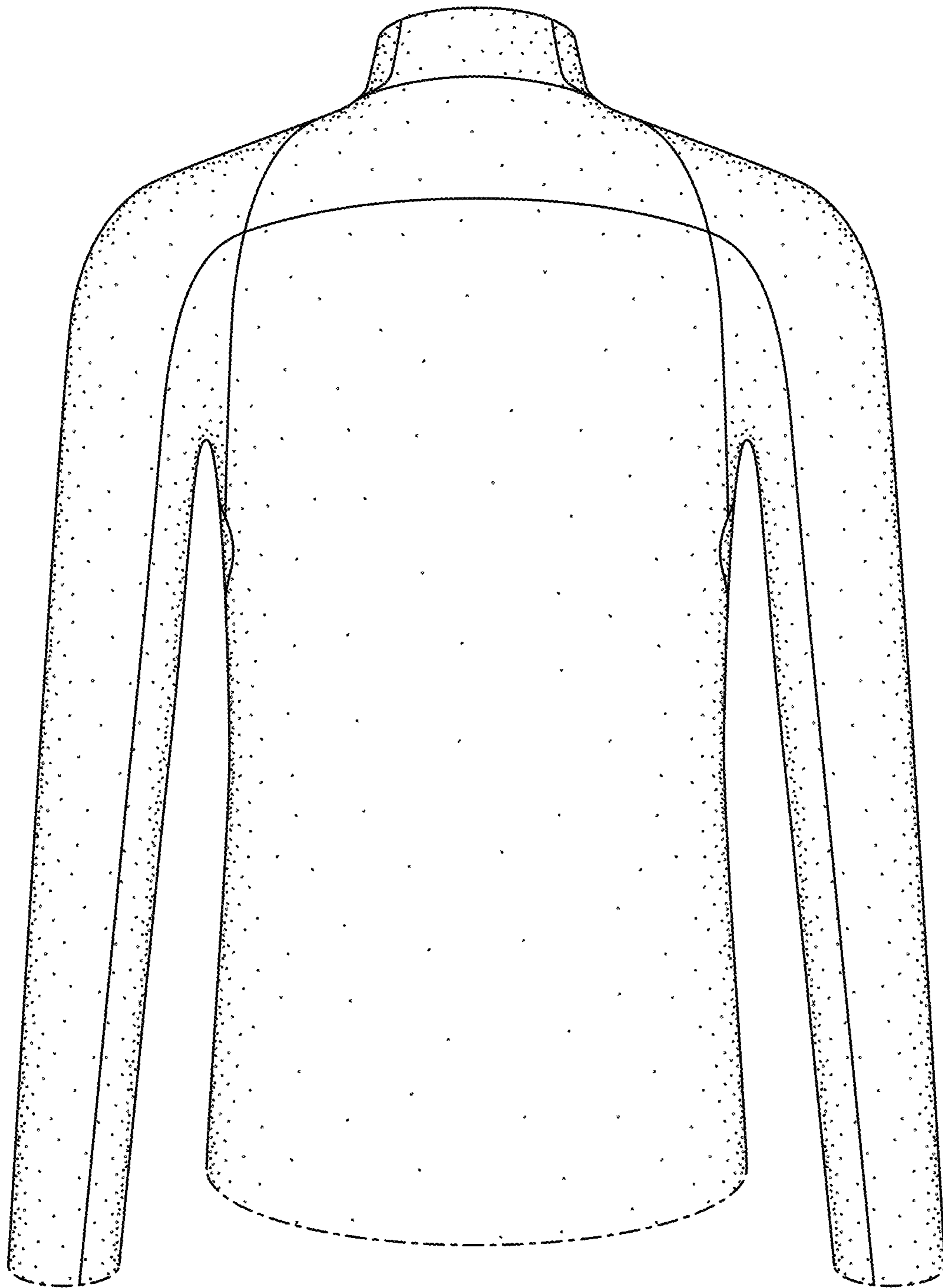

FIG. 3

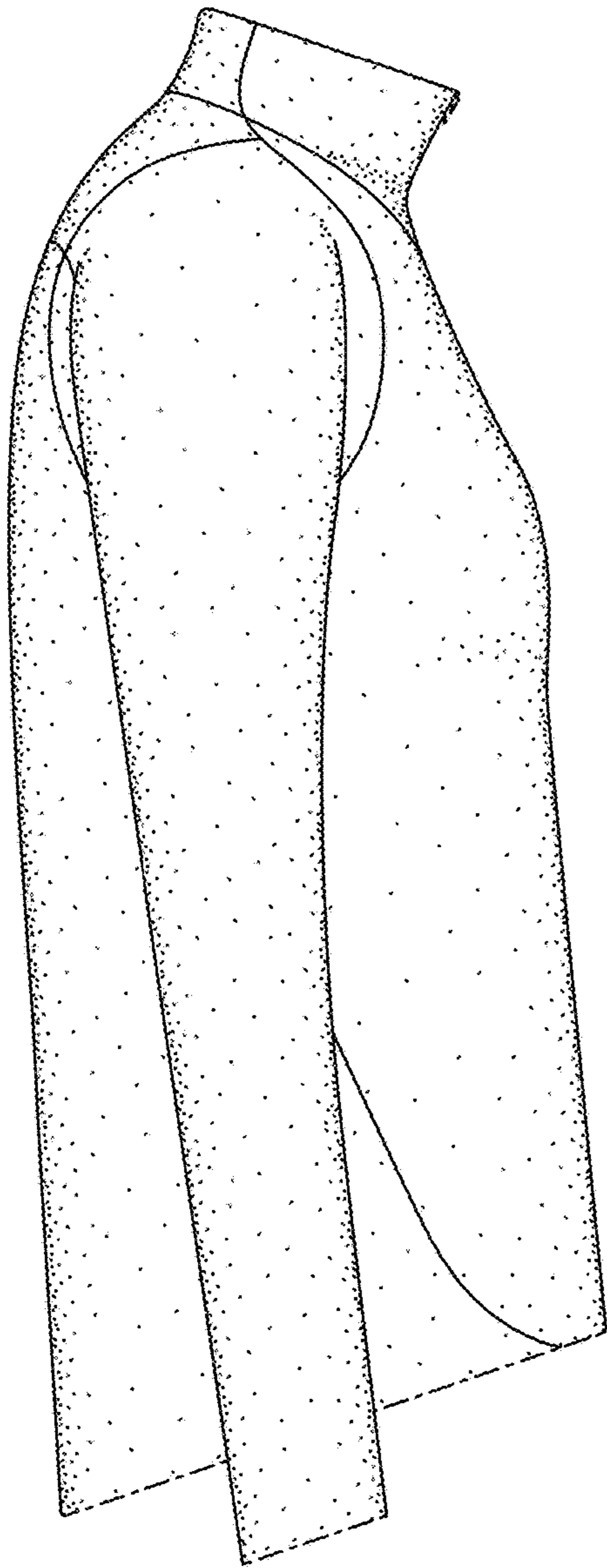

FIG. 4

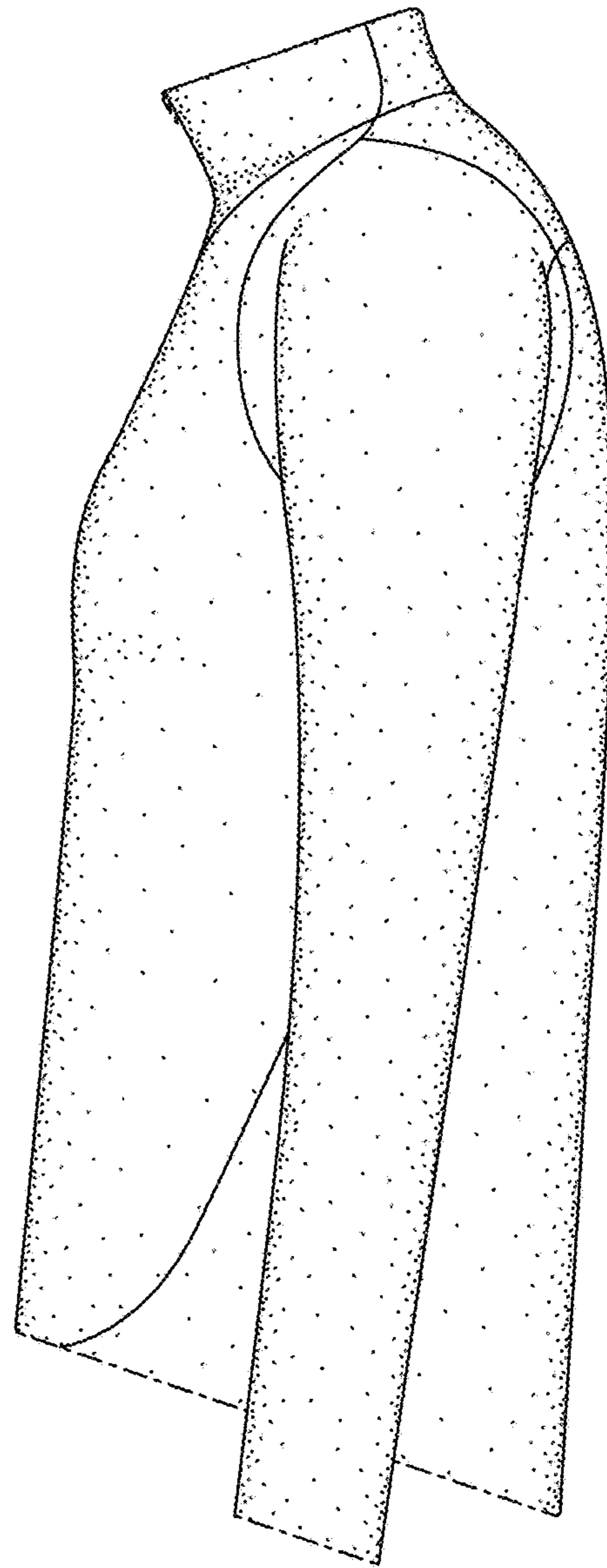

FIG. 5

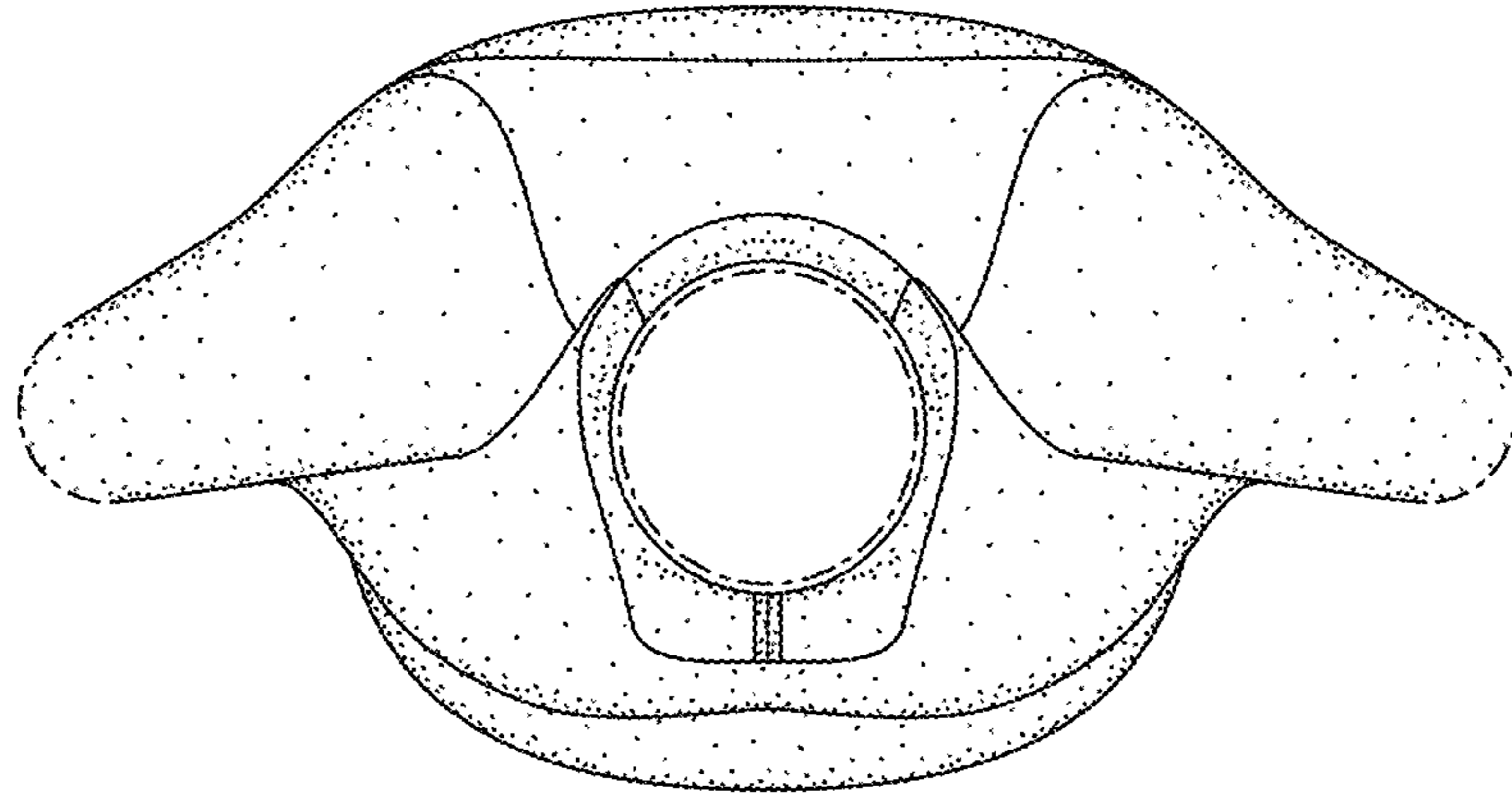

FIG. 6

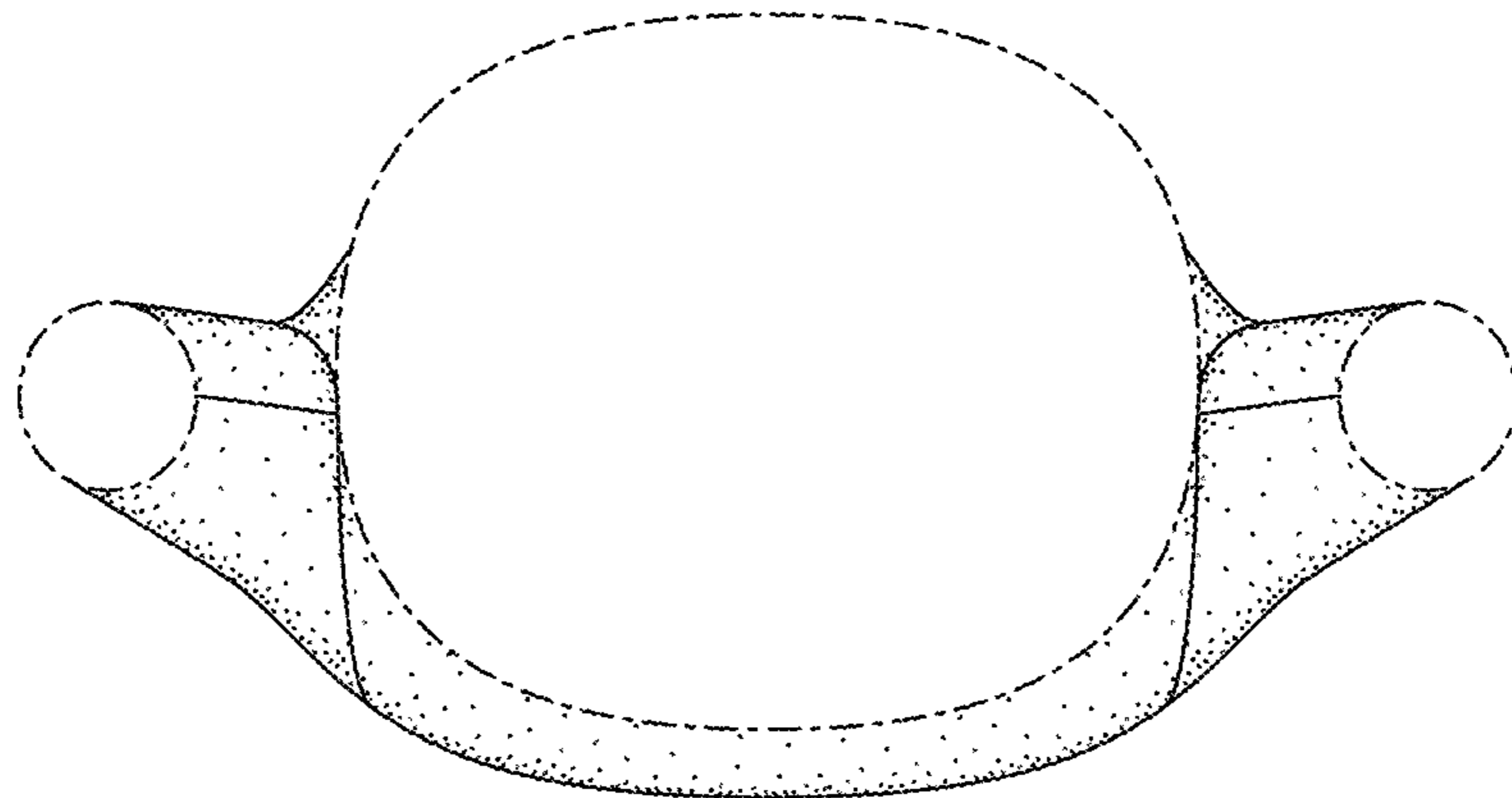

FIG. 7

UNITED STATES PATENT AND TRADEMARK OFFICE
CERTIFICATE OF CORRECTION

PATENT NO. : D796,782 S
APPLICATION NO. : 29/557492
DATED : September 12, 2017
INVENTOR(S) : Niloufar Mozafari

Page 1 of 1

It is certified that error appears in the above-identified patent and that said Letters Patent is hereby corrected as shown below:

On the Title Page

Insert under Item (30) Foreign Application Priority Data:

-- Feb 10, 2016 (EM) 002980474-0029 --

Signed and Sealed this
Thirtieth Day of June, 2020

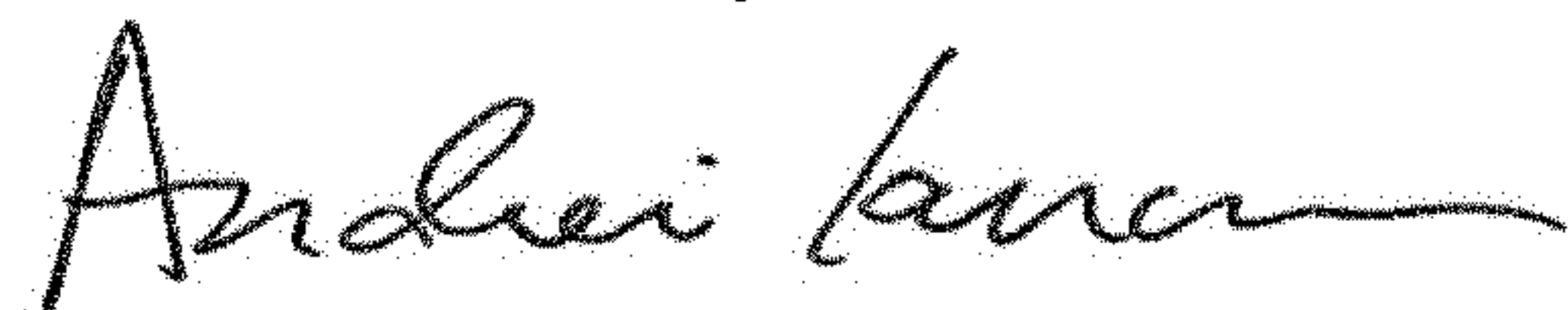

Andrei Iancu
Director of the United States Patent and Trademark Office