



US00D796748S

(12) **United States Design Patent**  
**Takagi et al.**

(10) **Patent No.:** **US D796,748 S**

(45) **Date of Patent:** **\*\* Sep. 5, 2017**

(54) **PET TOILET**

(71) Applicant: **UNICHARM CORPORATION**,  
Ehime (JP)

(72) Inventors: **Chiyo Takagi**, Kagawa (JP); **Shinya Kaneko**, Kagawa (JP); **Terutoki Kobayashi**, Toyama (JP); **Mitsuo Sugitani**, Toyama (JP)

(73) Assignee: **Unicharm Corporation**, Ehime (JP)

(\*\*) Term: **15 Years**

(21) Appl. No.: **29/530,770**

(22) Filed: **Jun. 19, 2015**

(30) **Foreign Application Priority Data**

Feb. 27, 2015 (JP) ..... 2015-004340

(51) **LOC (10) Cl.** ..... **30-99**

(52) **U.S. Cl.**  
USPC ..... **D30/161**

(58) **Field of Classification Search**  
USPC ..... D30/161; D3/304  
CPC .... A01K 1/011; A01K 1/0107; A01K 1/0117;  
A01K 1/0121; A01K 1/0125; A47K  
11/02; A47K 11/06; A47K 13/00; A47K  
13/06; A47K 13/14  
See application file for complete search history.

(56) **References Cited**

**U.S. PATENT DOCUMENTS**

D512,542 S \* 12/2005 Northrop ..... D30/161  
7,131,396 B2 \* 11/2006 Matsuo ..... A01K 1/0114  
119/166  
7,380,519 B2 \* 6/2008 Ikegami ..... A01K 1/0107  
119/161  
D638,590 S \* 5/2011 Lipscomb ..... D30/161

D652,587 S \* 1/2012 Matsuo ..... D30/161  
8,181,601 B2 \* 5/2012 Kratzer ..... A01K 1/0107  
119/161  
D679,461 S \* 4/2013 Chance ..... D30/161  
D728,173 S \* 4/2015 Matsuo ..... D30/161  
2009/0000558 A1 \* 1/2009 Matsuo ..... A01K 1/0114  
119/165

**FOREIGN PATENT DOCUMENTS**

JP D1031394 2/1999  
JP D1240264 5/2005  
JP D1295093 2/2007  
JP D1348259 1/2009  
JP D1379780 2/2010  
JP D1436193 3/2012

\* cited by examiner

*Primary Examiner* — Cathy Anne MacCormac

(74) *Attorney, Agent, or Firm* — Brinks Gilson & Lione

(57) **CLAIM**

The ornamental design for a pet toilet, as shown and described.

**DESCRIPTION**

FIG. 1 is a front perspective view of a pet toilet showing our new design;  
FIG. 2 is a front view thereof;  
FIG. 3 is a rear view thereof;  
FIG. 4 is a left side view thereof, a right side view is a mirror image of the left side view;  
FIG. 5 is a top plan view thereof;  
FIG. 6 is a bottom plan view thereof; and,  
FIG. 7 is a rear perspective view thereof.  
The broken lines in the drawings depict environmental subject matter and are not part of the claimed design.

**1 Claim, 7 Drawing Sheets**

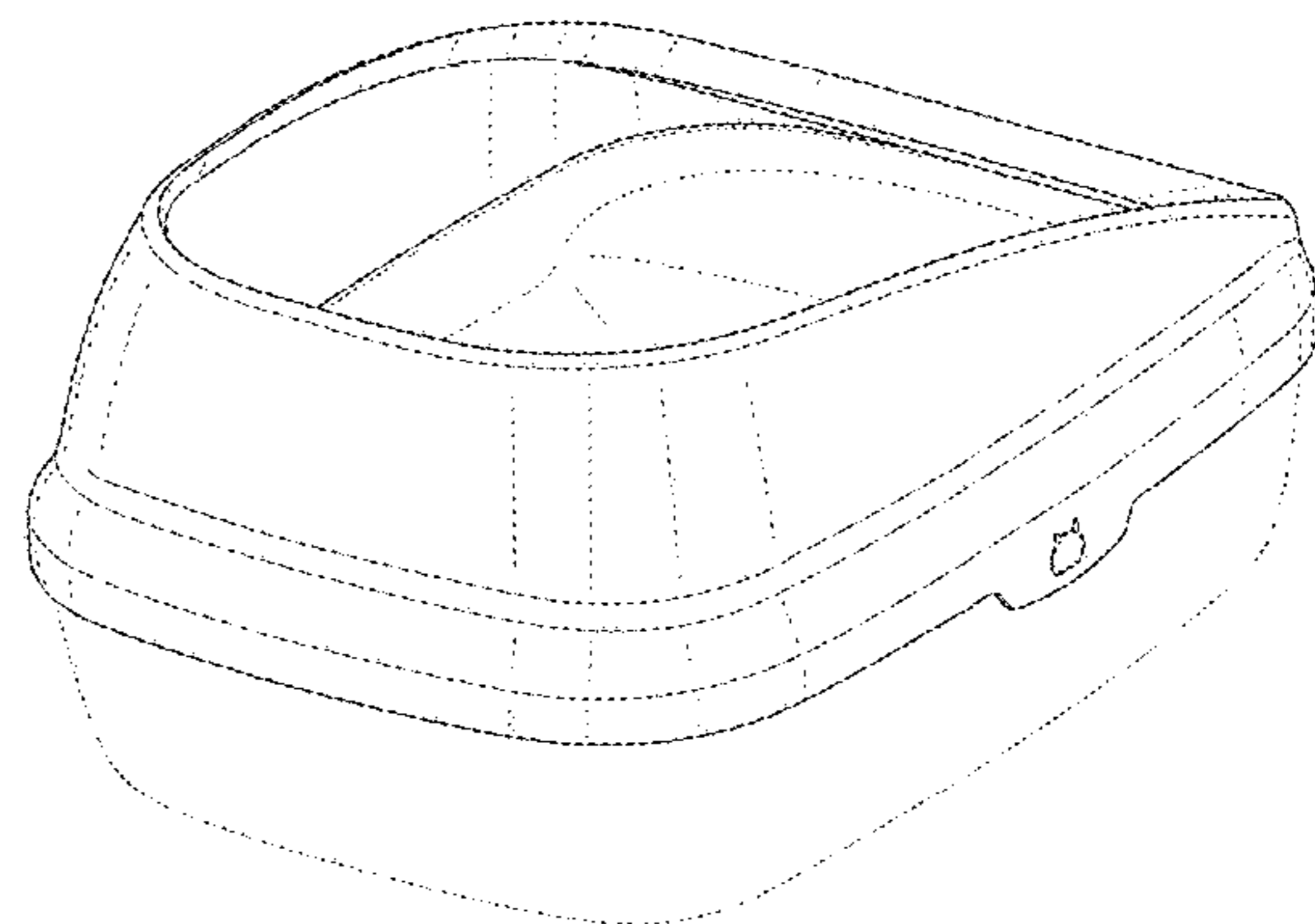
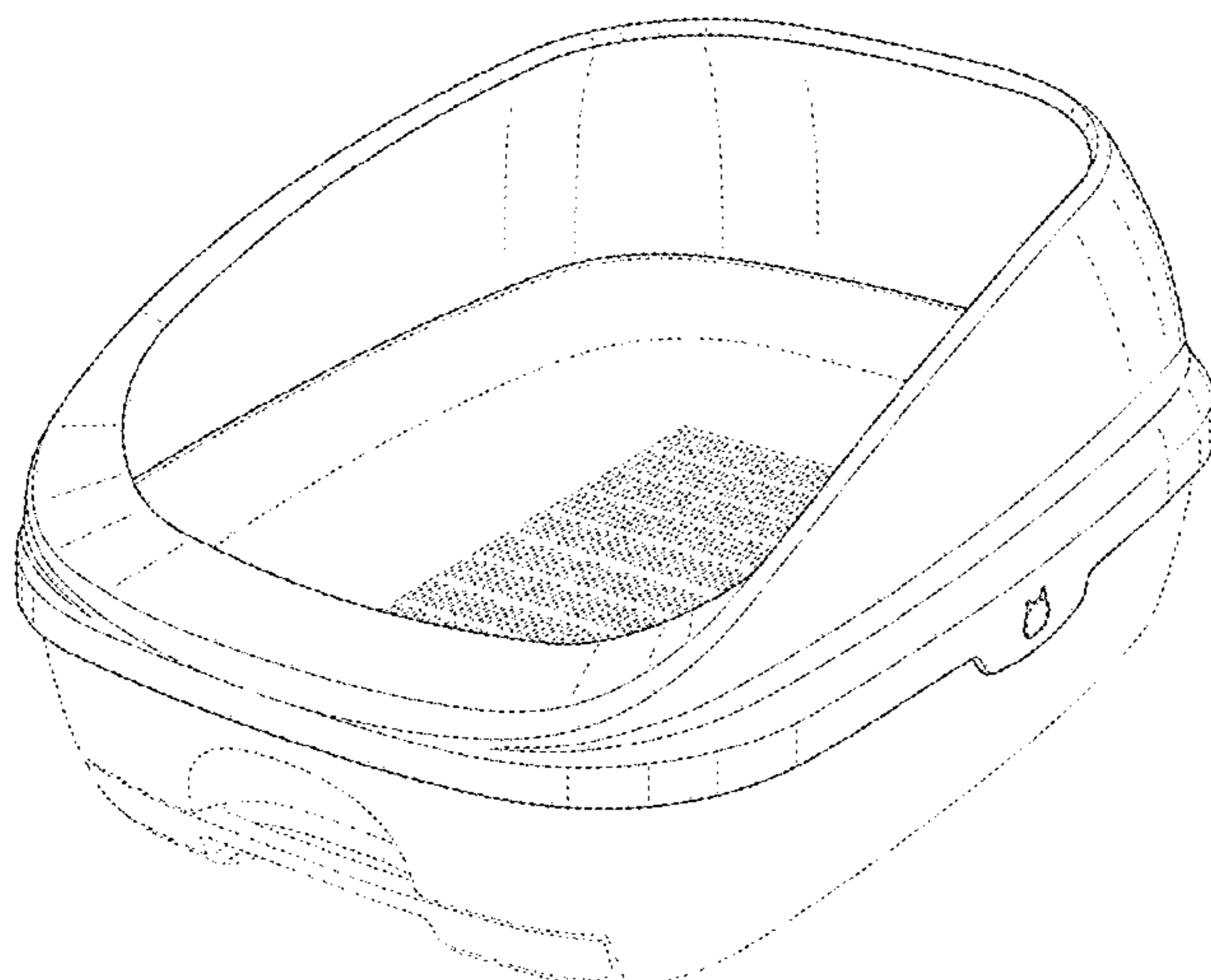

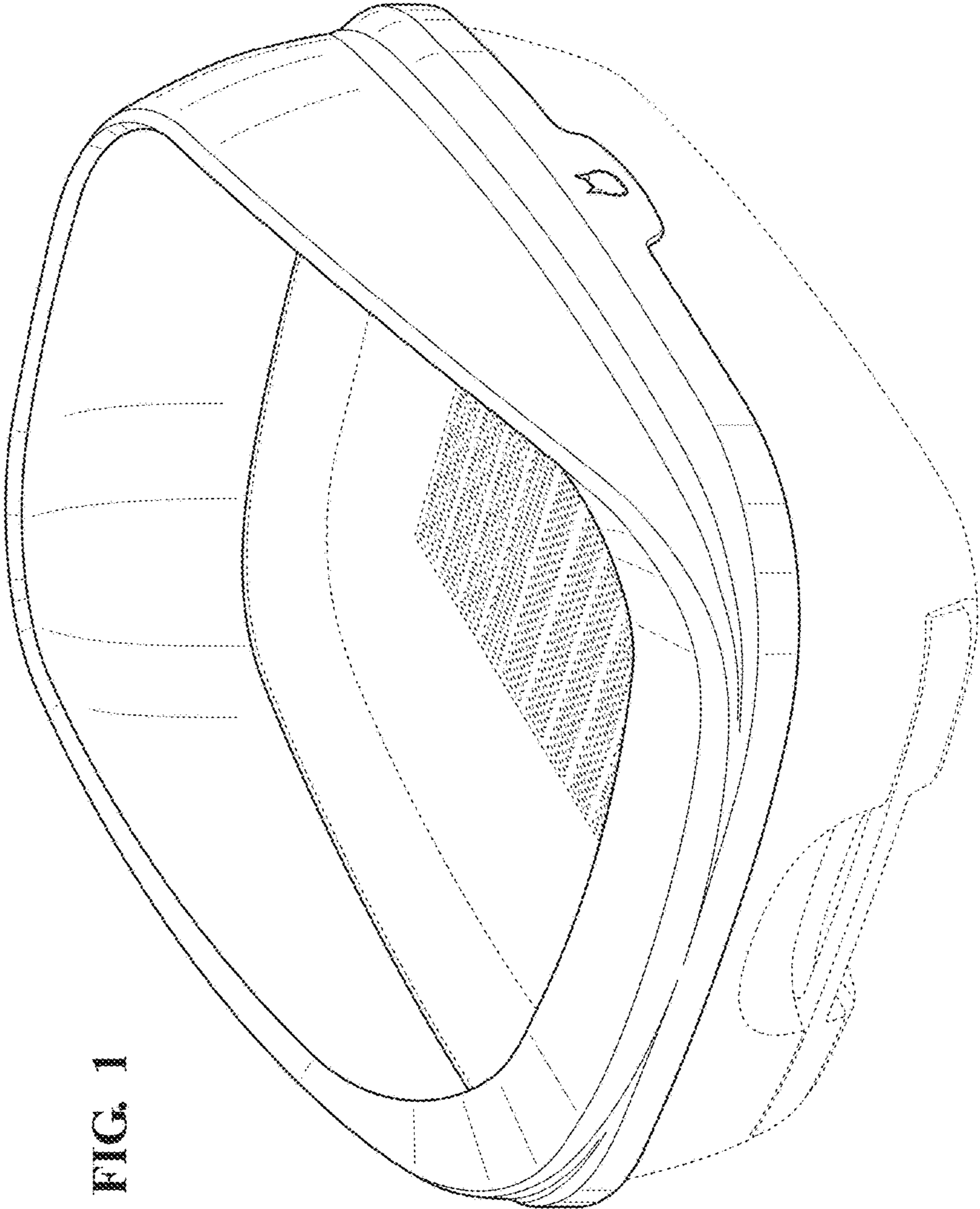

FIG. 1

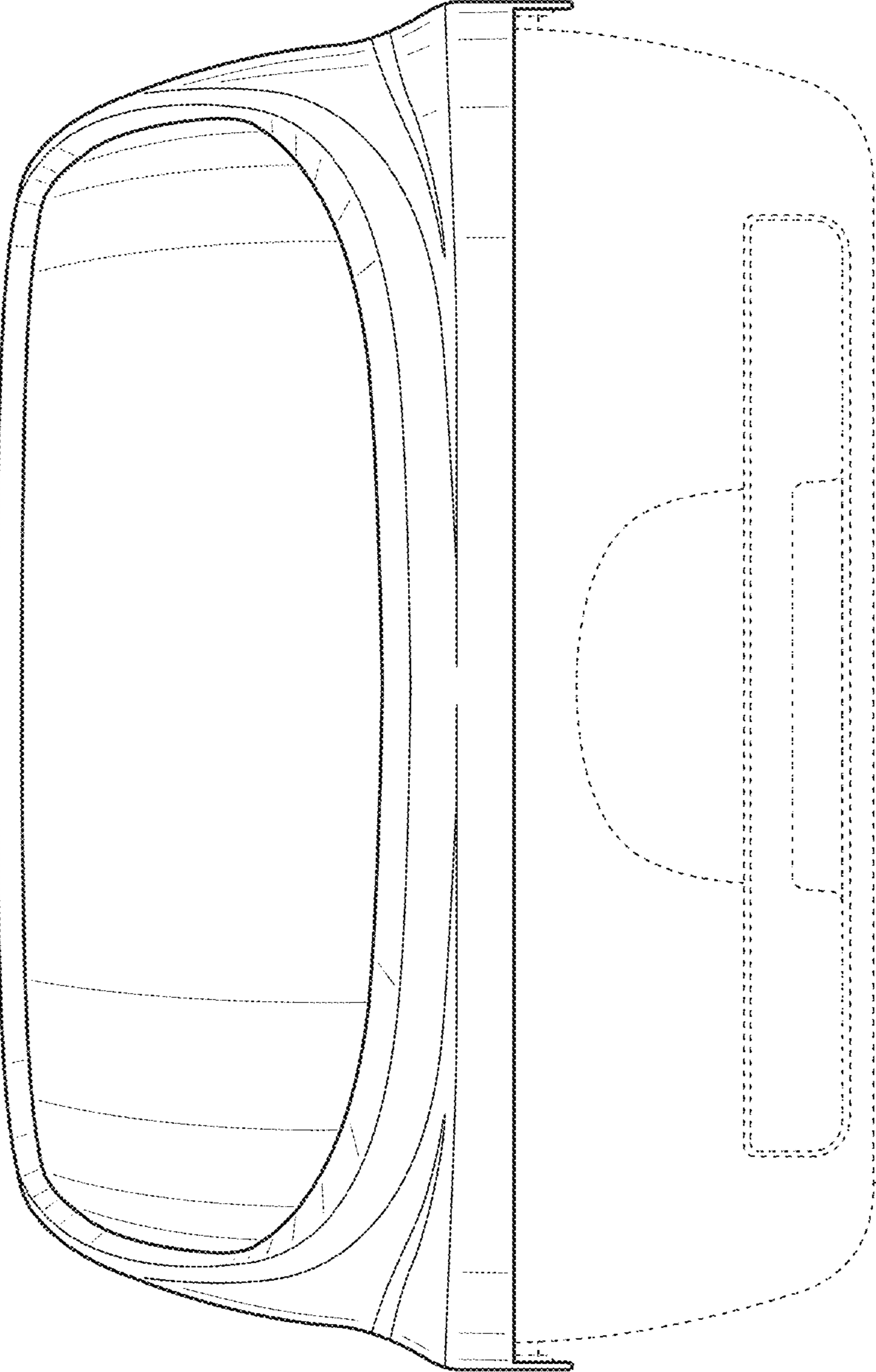

FIG. 2

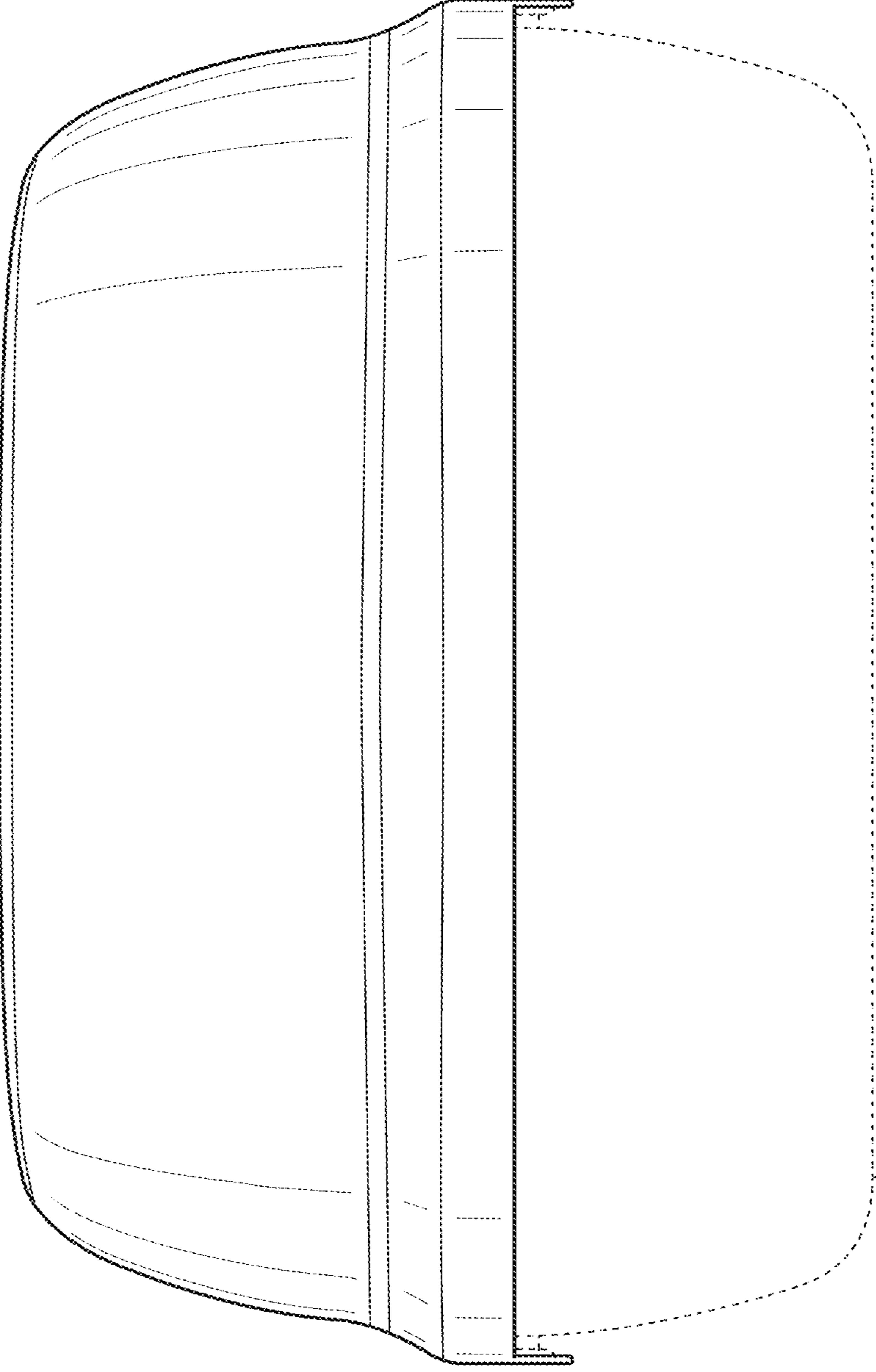

FIG. 3

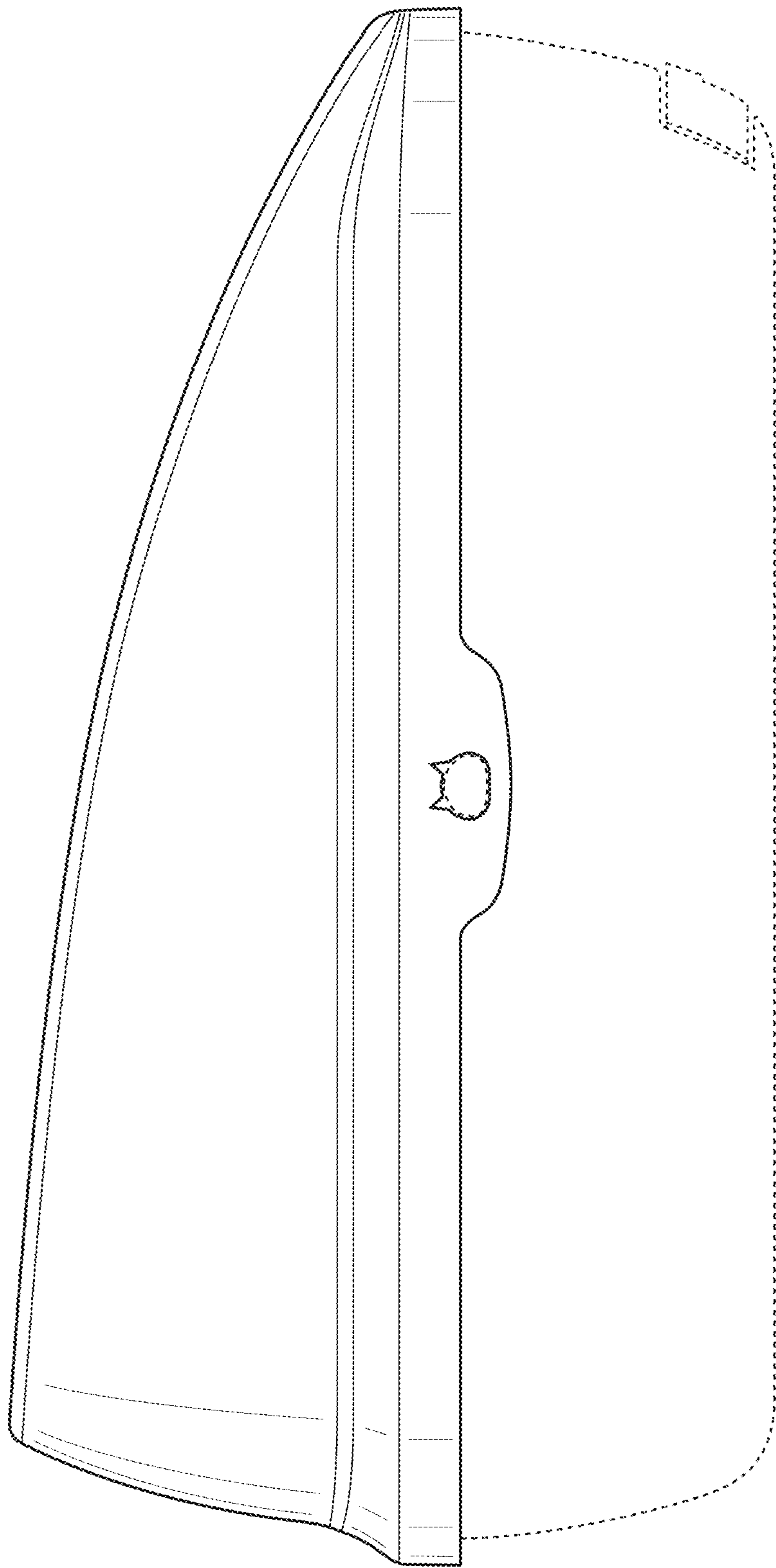

FIG. 4

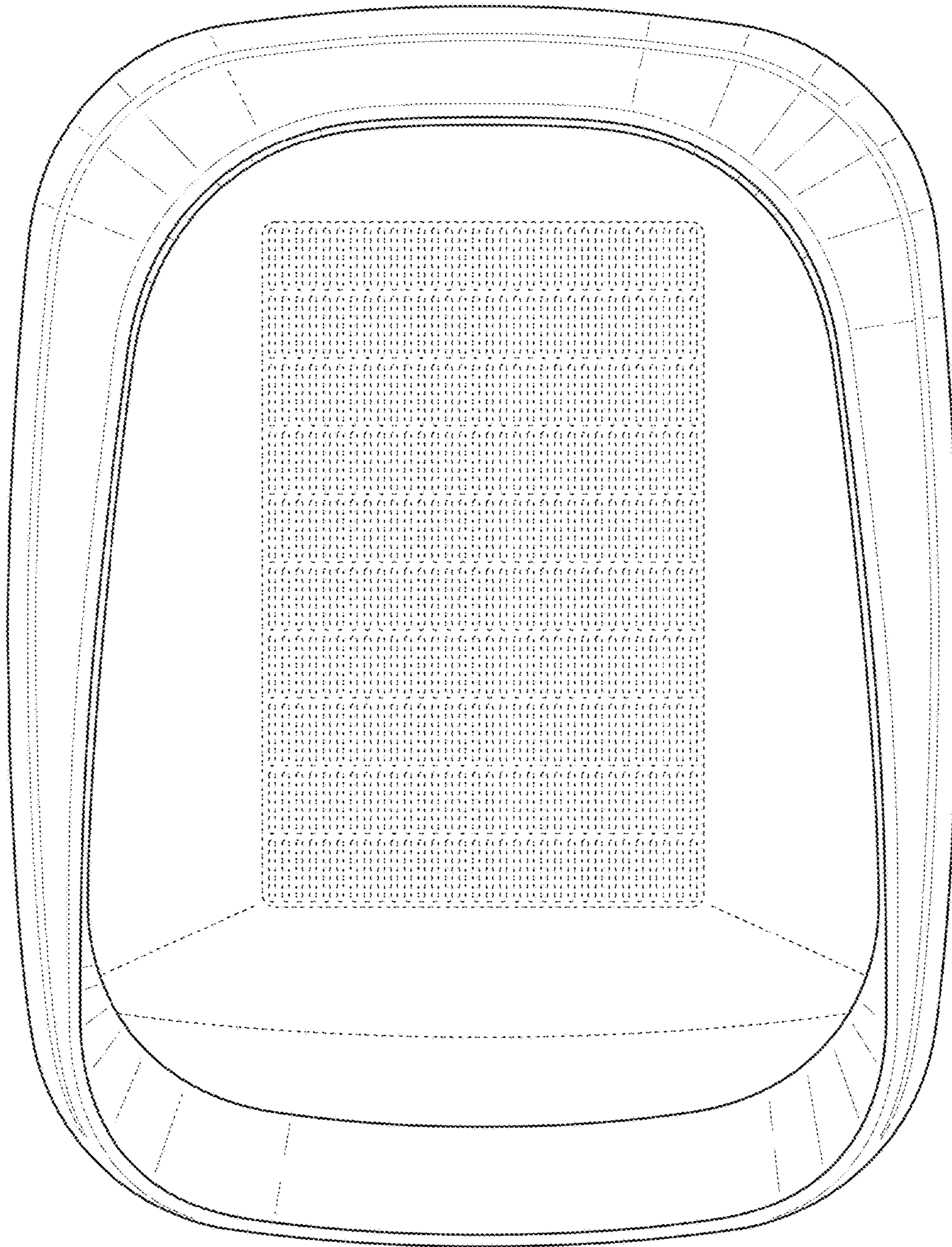

FIG. 5

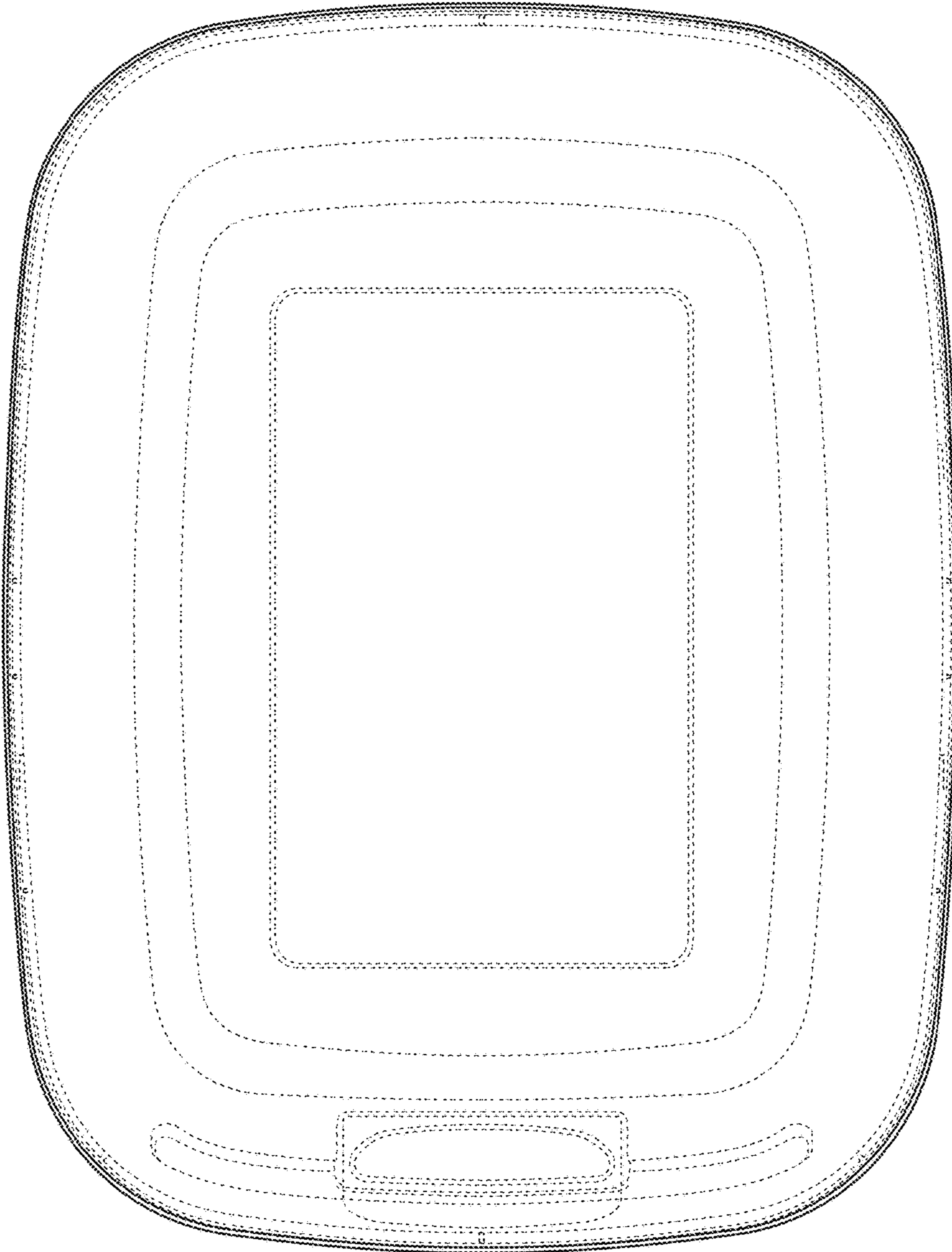

FIG. 6

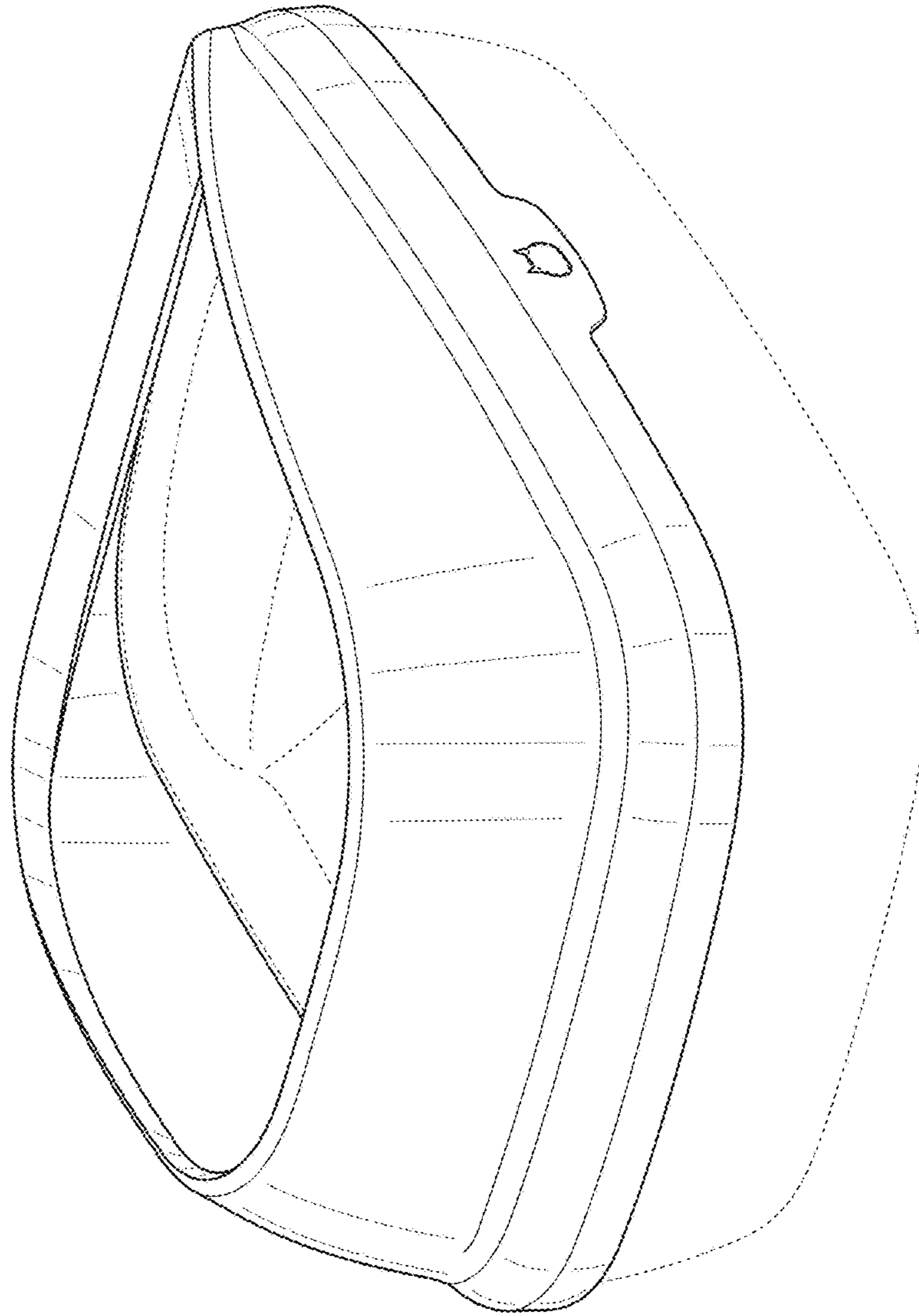

FIG. 7