



US00D796717S

(12) **United States Design Patent** (10) **Patent No.:** **US D796,717 S**
Wu (45) **Date of Patent:** **** Sep. 5, 2017**

(54) **LASER POINTER**
(71) Applicant: **Xinchao Wu**, Guangdong (CN)
(72) Inventor: **Xinchao Wu**, Guangdong (CN)
(**) Term: **15 Years**
(21) Appl. No.: **29/553,724**
(22) Filed: **Feb. 4, 2016**

D429,830 S * 8/2000 Ting D26/37
D429,831 S * 8/2000 Ting D26/37
D455,513 S * 4/2002 Galli D26/49
D474,551 S * 5/2003 Gohl D26/37
D489,469 S * 5/2004 Liou D26/37
D517,023 S * 3/2006 Kumagai D13/168
D531,334 S * 10/2006 Lin D26/37
D537,181 S * 2/2007 Chen D14/480.3
D548,863 S * 8/2007 Shiu D26/37
D582,915 S * 12/2008 Leung D14/480.3
D612,086 S * 3/2010 Brauer D26/42
D616,936 S * 6/2010 Liu D19/170
D725,810 S * 3/2015 Jeong D26/38

(30) **Foreign Application Priority Data**

Dec. 11, 2015 (CN) 2015 3 0523193

(51) **LOC (10) Cl.** **26-02**

(52) **U.S. Cl.**
USPC **D26/49; D26/38**

(58) **Field of Classification Search**
USPC D26/37, 38, 40, 42, 44, 46, 51
CPC F21L 2003/00; F21L 4/00; F21L 4/005;
F21L 4/02; F21L 4/025; F21L 4/027;
F21L 4/04; F21L 4/08; F21L 2005/00;
F21L 7/00; F21L 11/00; F21L 13/00;
F21L 13/04; F21L 13/08; F21L 14/02;
F21L 17/00; F21L 19/00

See application file for complete search history.

(56) **References Cited**

U.S. PATENT DOCUMENTS

D332,965 S * 2/1993 Wu D26/37
D359,482 S * 6/1995 Huang D26/37
D403,450 S * 12/1998 Ting D26/37
D419,704 S * 1/2000 Ting D26/37

* cited by examiner

Primary Examiner — Lakiya Rogers
Assistant Examiner — Carissa C Fitts

(57) **CLAIM**

The ornamental design for a laser pointer, as shown and described.

DESCRIPTION

FIG. 1 is a front elevational view of a laser pointer showing my new design;
FIG. 2 is a rear elevational view thereof;
FIG. 3 is a left side view thereof;
FIG. 4 is a right side view thereof;
FIG. 5 is a top plan view thereof;
FIG. 6 is a bottom plan view thereof;
FIG. 7 is a first perspective view thereof; and,
FIG. 8 is a second perspective view thereof.
The broken lines show portions of the article not claimed and form no part of the claimed design.

1 Claim, 8 Drawing Sheets

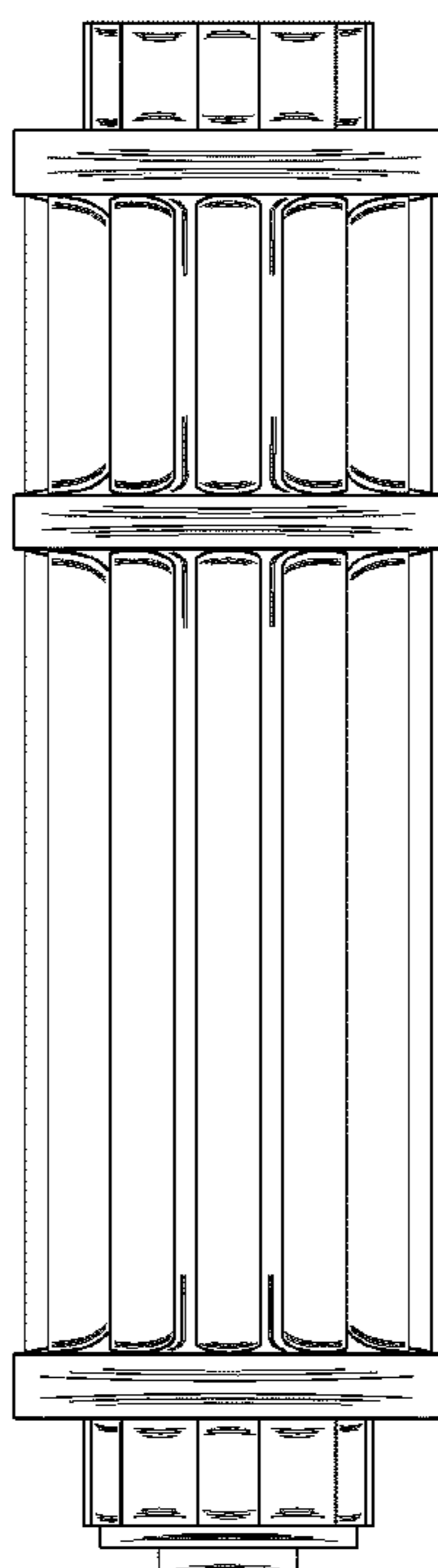

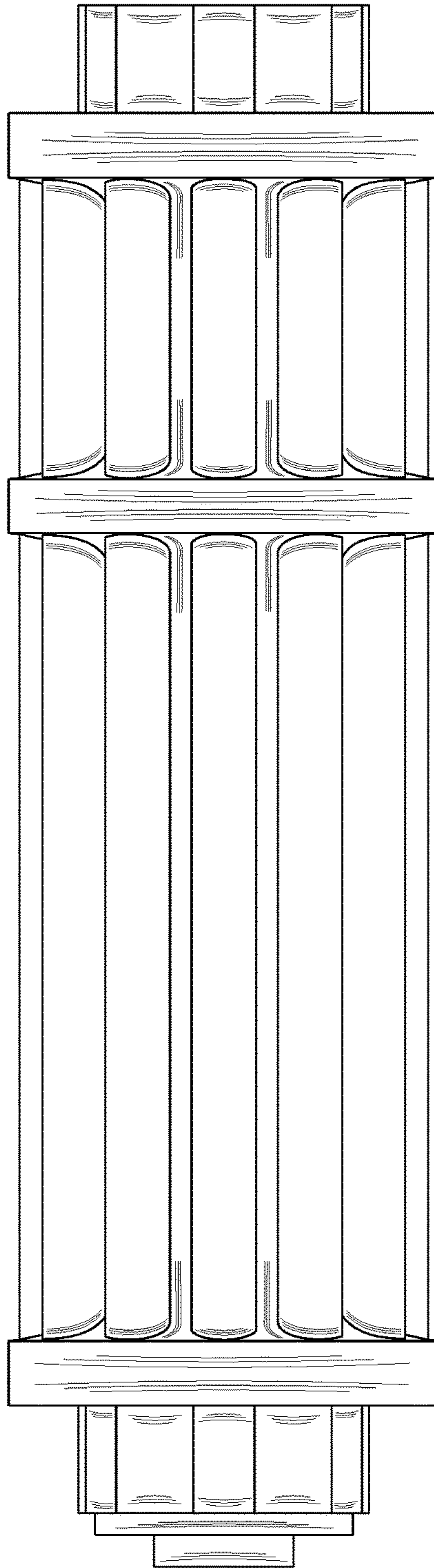

Fig. 1

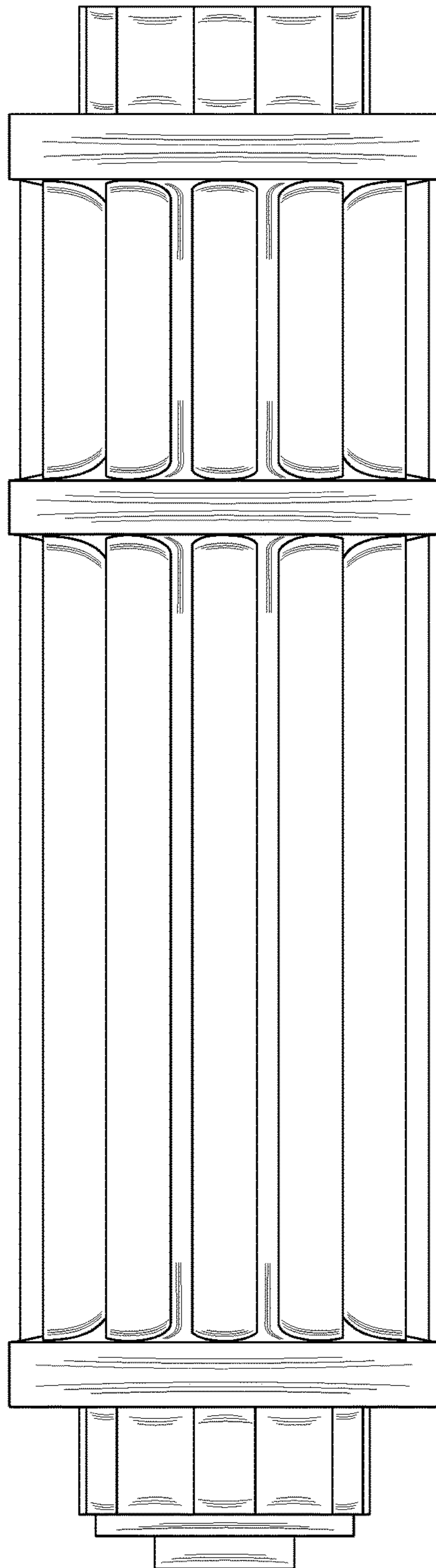

Fig. 2

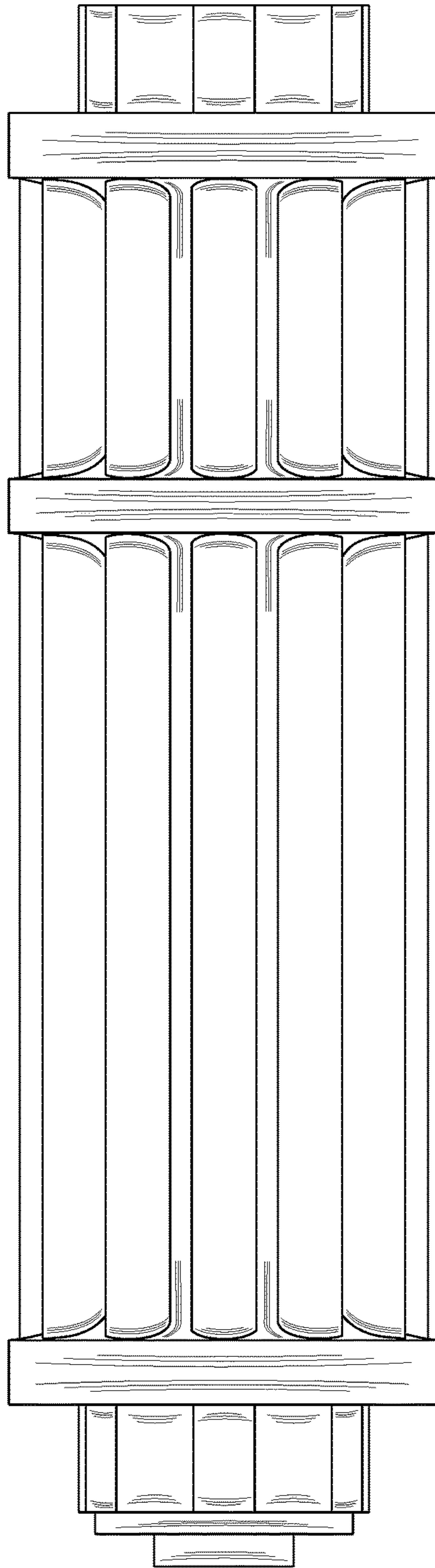

Fig. 3

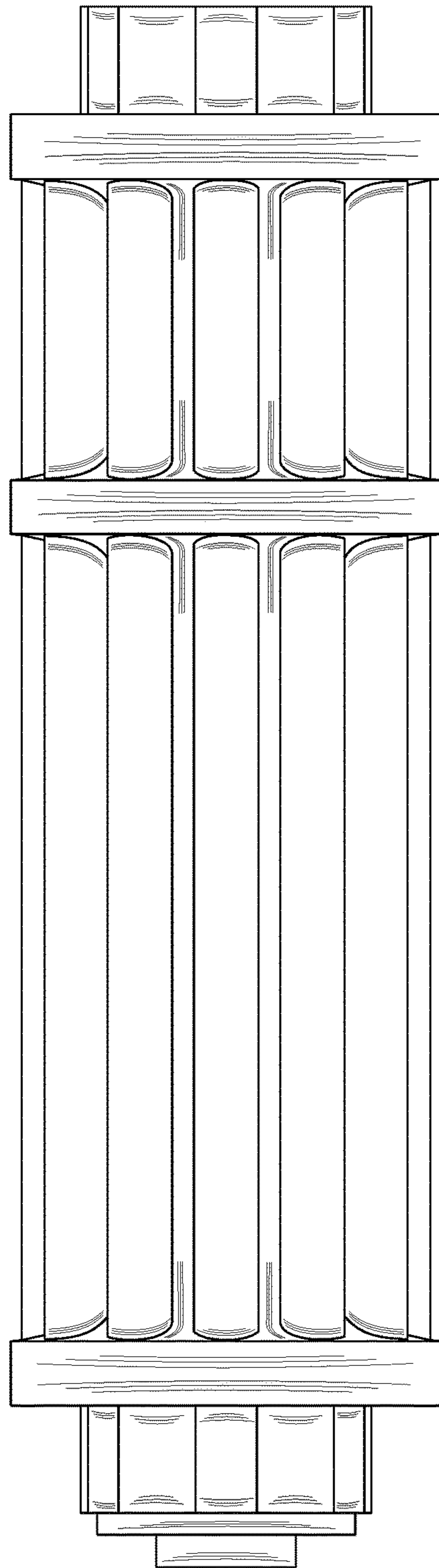

Fig. 4

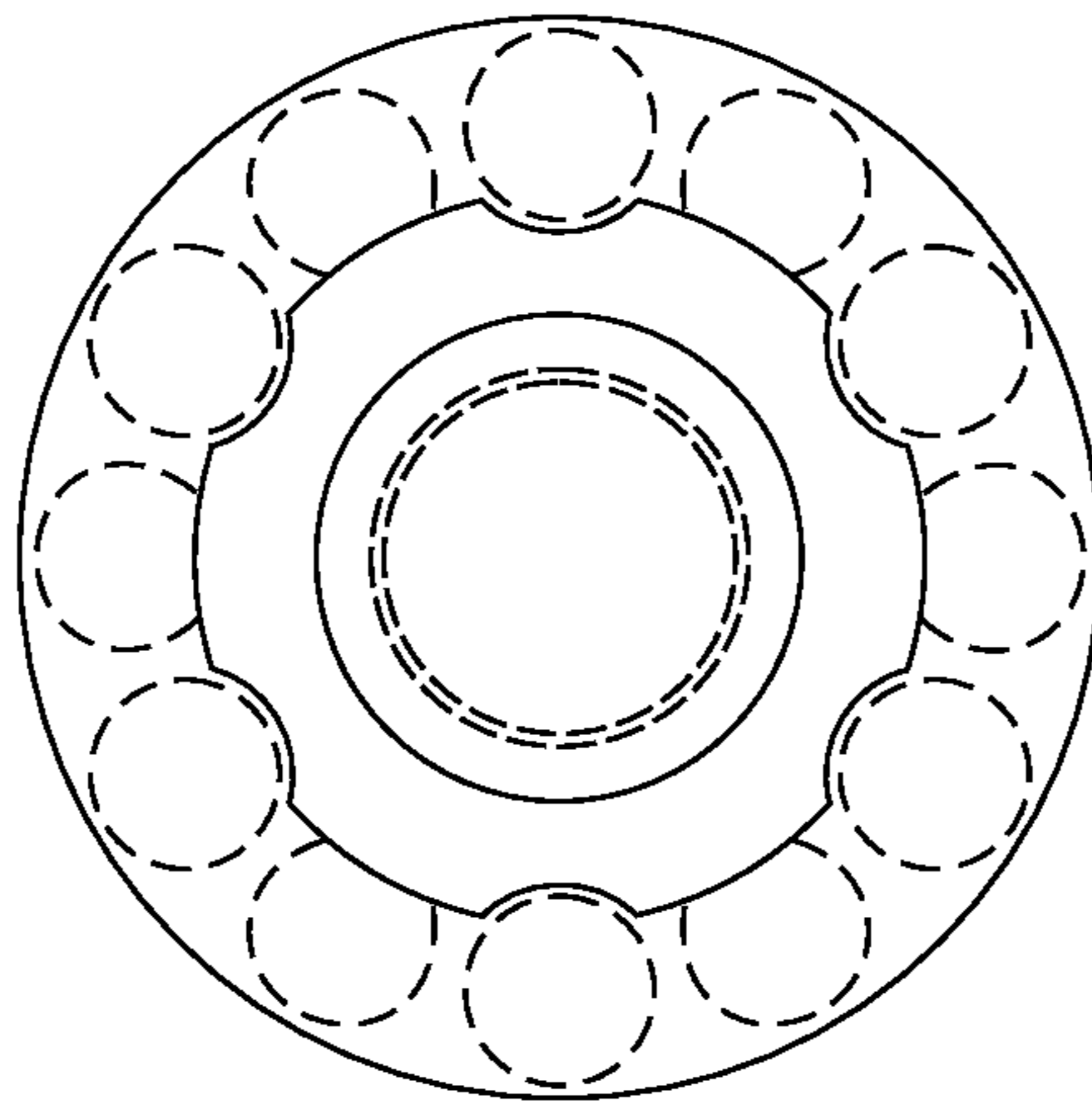

Fig. 5

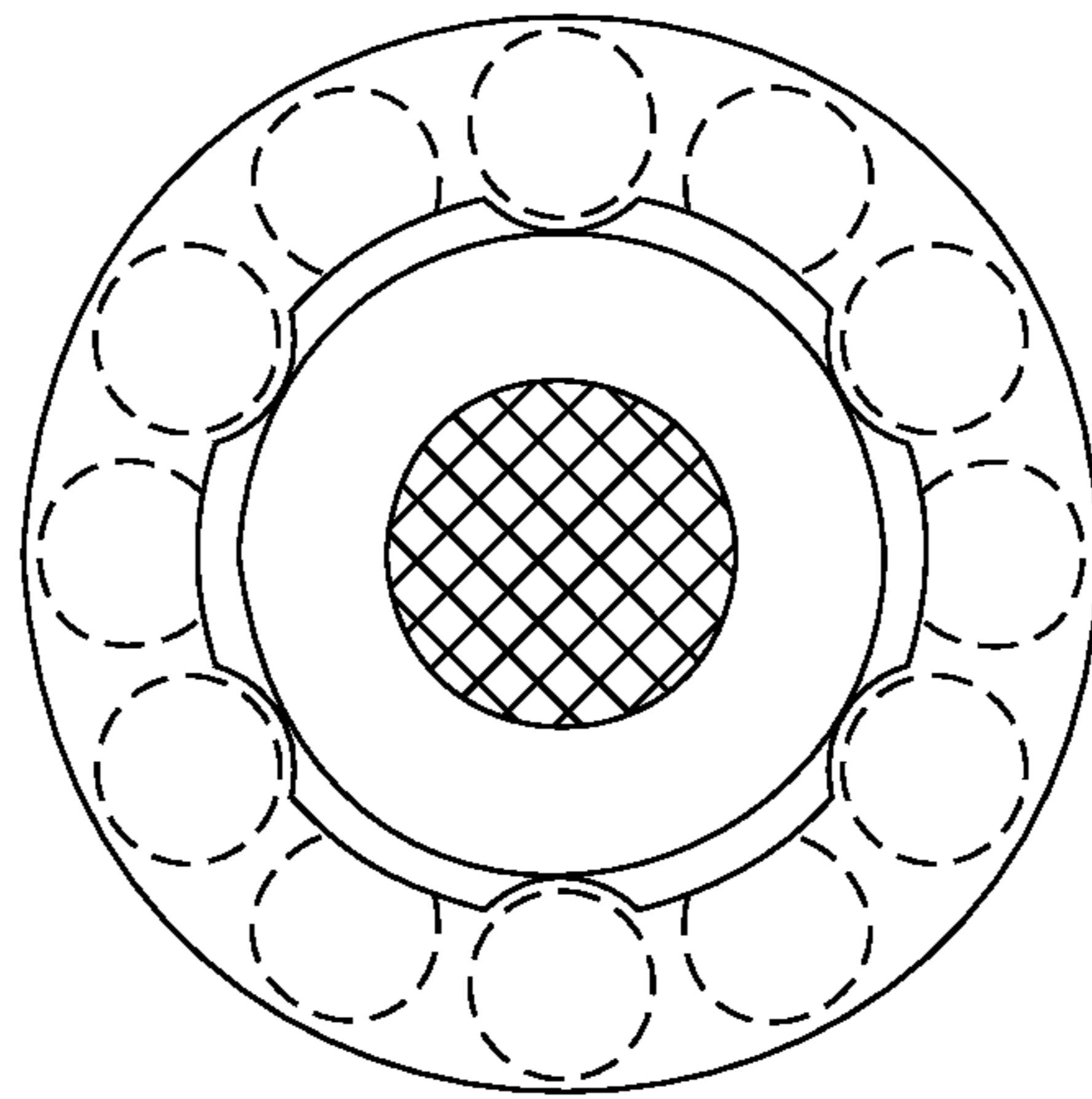

Fig. 6

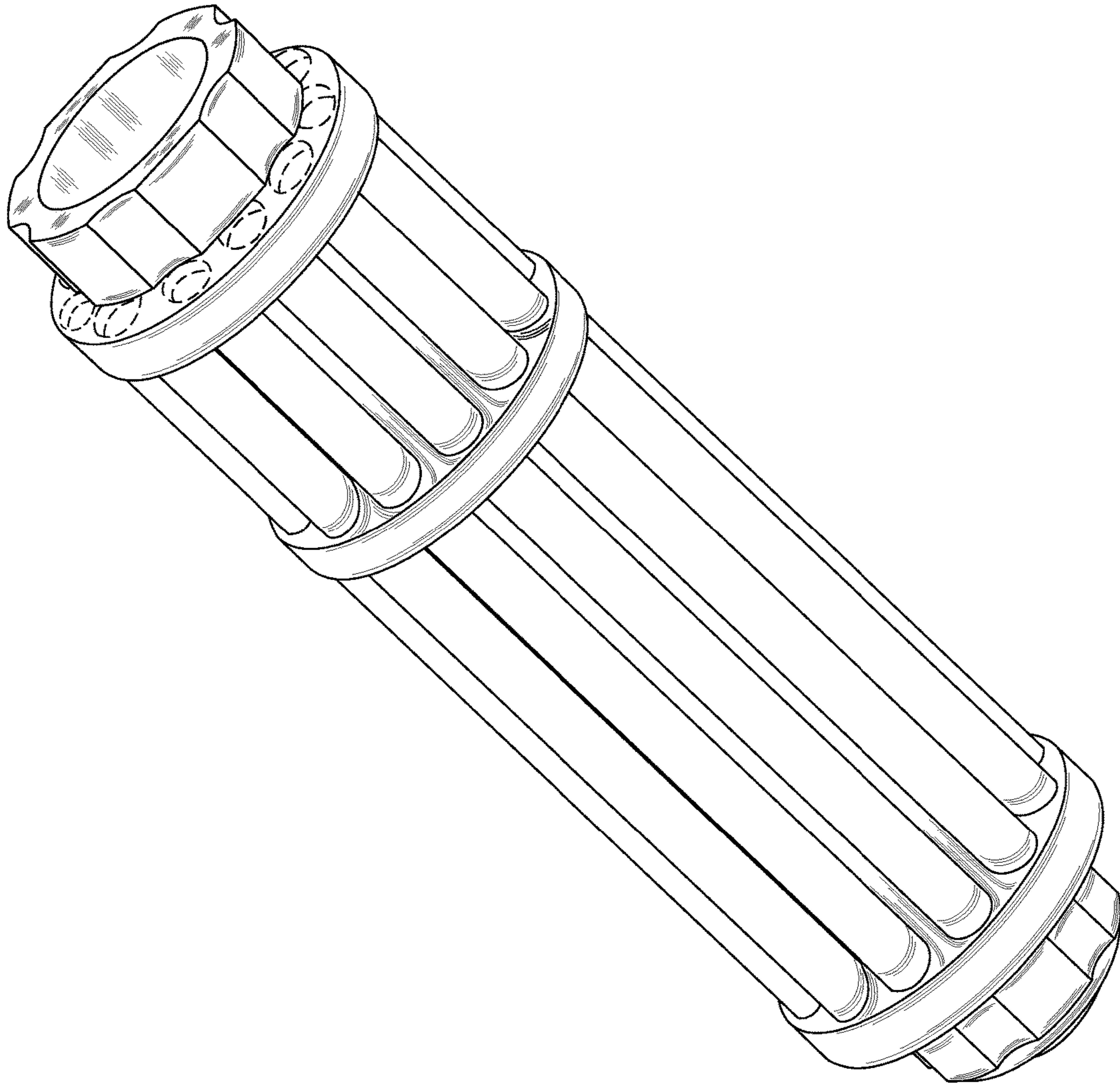

Fig. 7

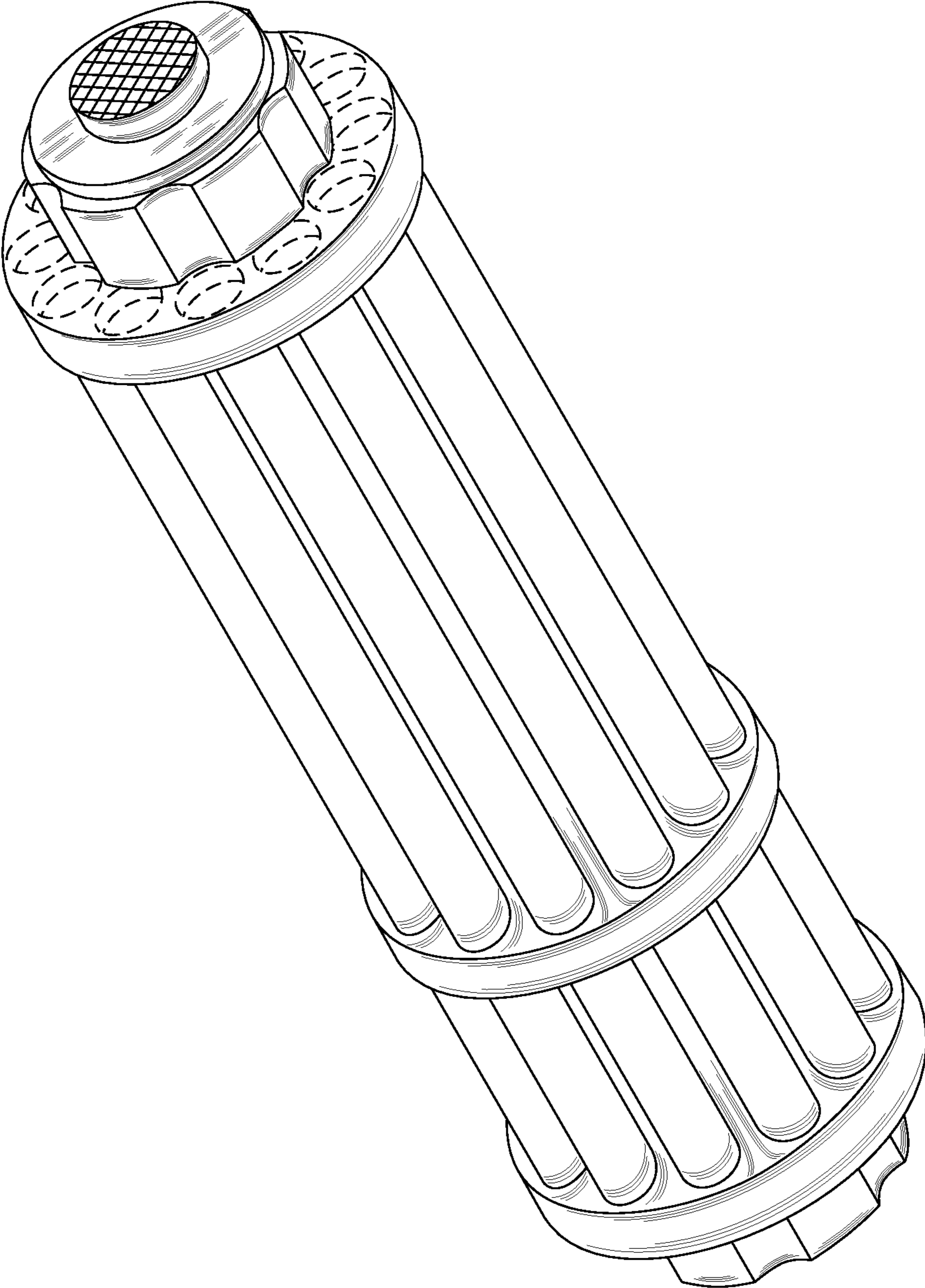

Fig. 8