

US00D796417S

(12) **United States Design Patent**
Klinck et al.

(10) **Patent No.:** **US D796,417 S**
(45) **Date of Patent:** **** Sep. 5, 2017**

(54) **GROOVED PASSENGER ASSIST STRAP WITH RAIL CLAMP**

(71) Applicant: **Amatrimara Inc.**, Oakville (CA)

(72) Inventors: **Michael Klinck**, Oakville (CA); **Scott Strong**, Oakville (CA)

(73) Assignee: **Amatrimara Inc.**, Oakville (CA)

(**) Term: **15 Years**

(21) Appl. No.: **29/542,353**

(22) Filed: **Oct. 13, 2015**

(51) **LOC (10) Cl.** **12-16**

(52) **U.S. Cl.**
USPC **D12/400**

(58) **Field of Classification Search**
USPC D12/107, 110, 114, 115, 117, 126, 400, D12/401, 404, 415, 423, 179; D25/48.1, D25/48.3
CPC . B60R 1/025; B60R 1/08; B62H 5/001; B62J 9/006; B65D 43/16; B65D 43/22; B65D 55/02; F21S 48/00; G01S 13/931
See application file for complete search history.

(56) **References Cited**

U.S. PATENT DOCUMENTS

1,650,429	A *	11/1927	Clark	B61D 49/00 105/354
1,729,988	A *	10/1929	Clark	B61D 49/00 105/354
1,799,062	A *	3/1931	Puzo	B61D 49/00 105/354
1,999,958	A *	4/1935	Clark	B61D 49/00 105/354
2,130,283	A *	9/1938	Lewis	B61D 49/00 105/354
2,137,622	A *	11/1938	Munro	B61D 49/00 105/354

2,500,415	A *	3/1950	Johnson	B60N 3/023 105/354
2,688,288	A *	9/1954	Harris	B61D 49/00 105/354
2,974,611	A *	3/1961	Tangeman	B61D 49/00 105/354
D202,294	S *	9/1965	Heifetz	D8/360
3,521,571	A *	7/1970	Maggio	B61D 37/00 105/354
4,562,792	A *	1/1986	Pak	A01K 27/004 119/797
D353,528	S *	12/1994	Glass	D8/98
D505,617	S *	5/2005	Eason	D8/396

(Continued)

OTHER PUBLICATIONS

River Drive Manufacturing Passenger Assist Straps and Handles, image post date Dec. 24, 2014, site visited Apr. 24, 2017, (online), <<https://web.archive.org/web/20141224045147/http://river-drive.com/products/>>.*

(Continued)

Primary Examiner — Kevin Rudzinski
Assistant Examiner — Sean D Lough
(74) *Attorney, Agent, or Firm* — Venjuris, P.C.

(57) **CLAIM**

The ornamental design for a grooved passenger assist strap with rail clamp, as shown and described.

DESCRIPTION

FIG. 1 is a front perspective view of a grooved passenger assist strap with rail clamp;
FIG. 2 is a front view thereof;
FIG. 3 is a back view thereof;
FIG. 4 is a right side view thereof;
FIG. 5 is a left side view thereof;
FIG. 6 is a top view thereof; and,
FIG. 7 is a bottom view thereof.

1 Claim, 3 Drawing Sheets

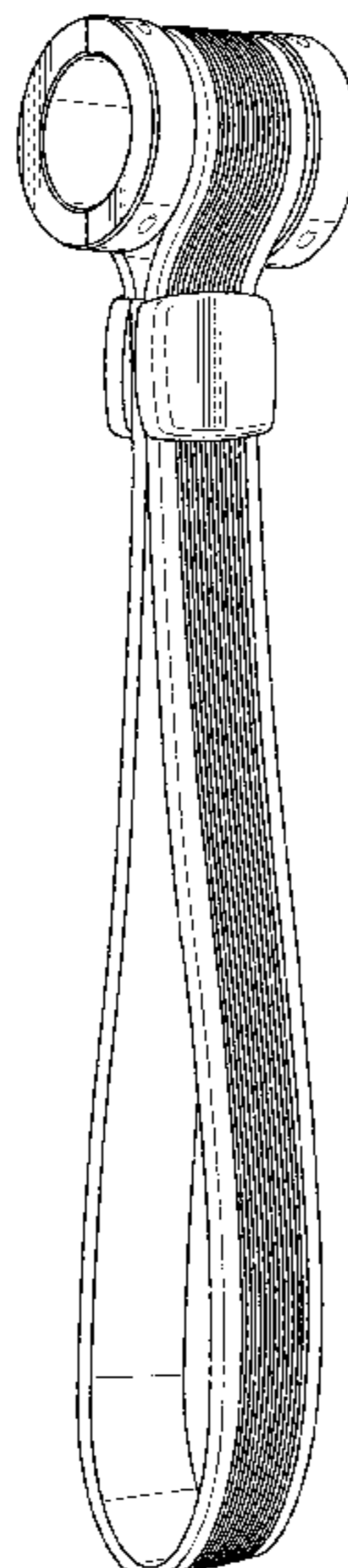

Fig. 1

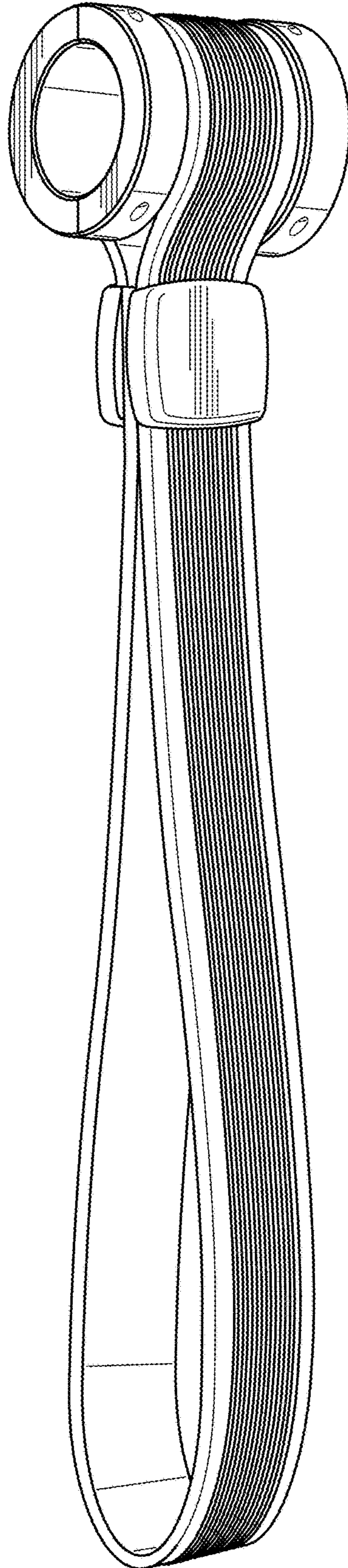

Fig. 2

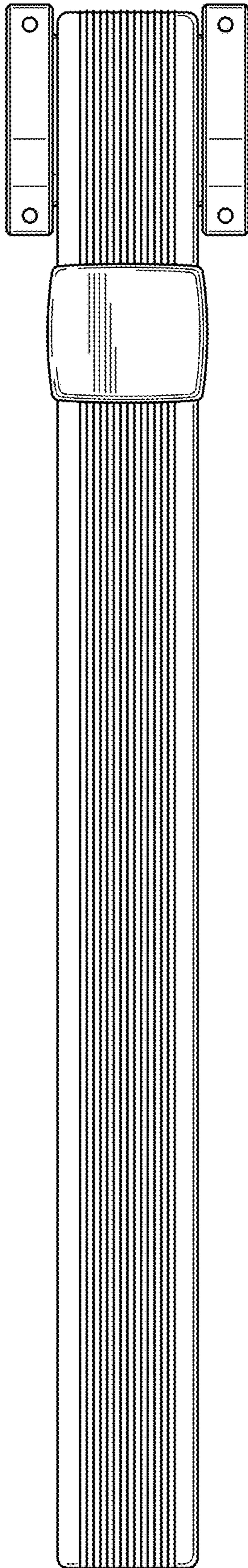

Fig. 3

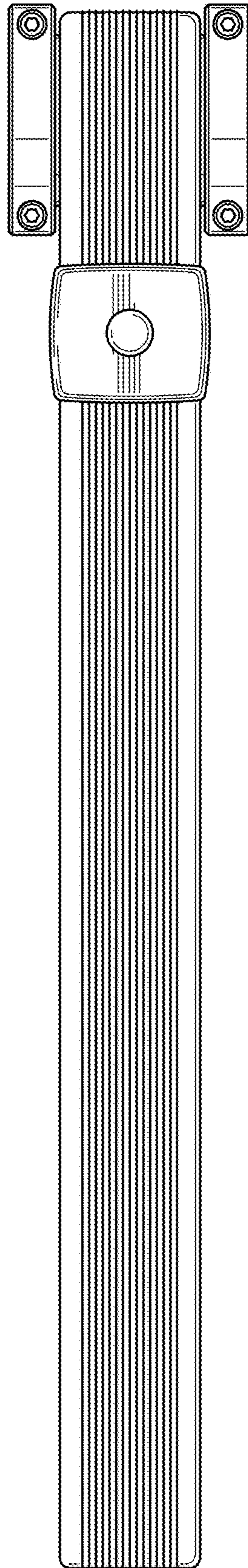

Fig. 4

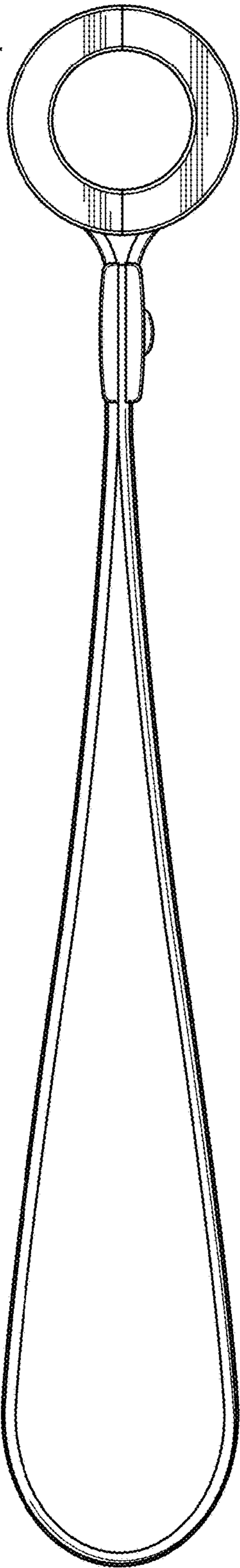

Fig. 5

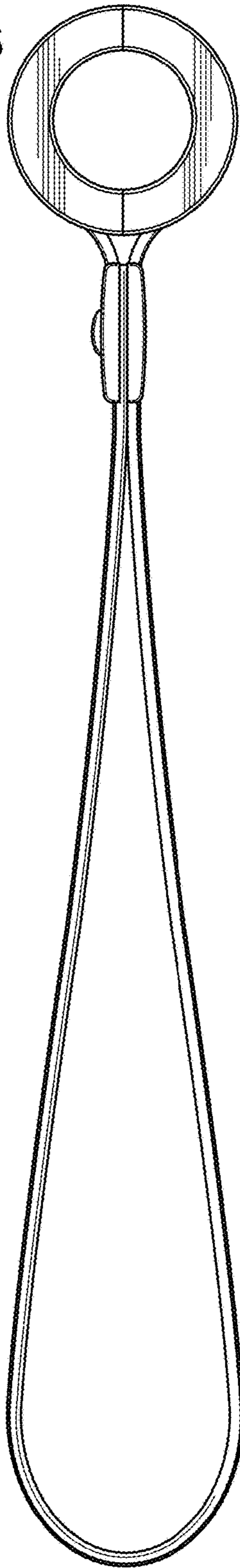

Fig. 6

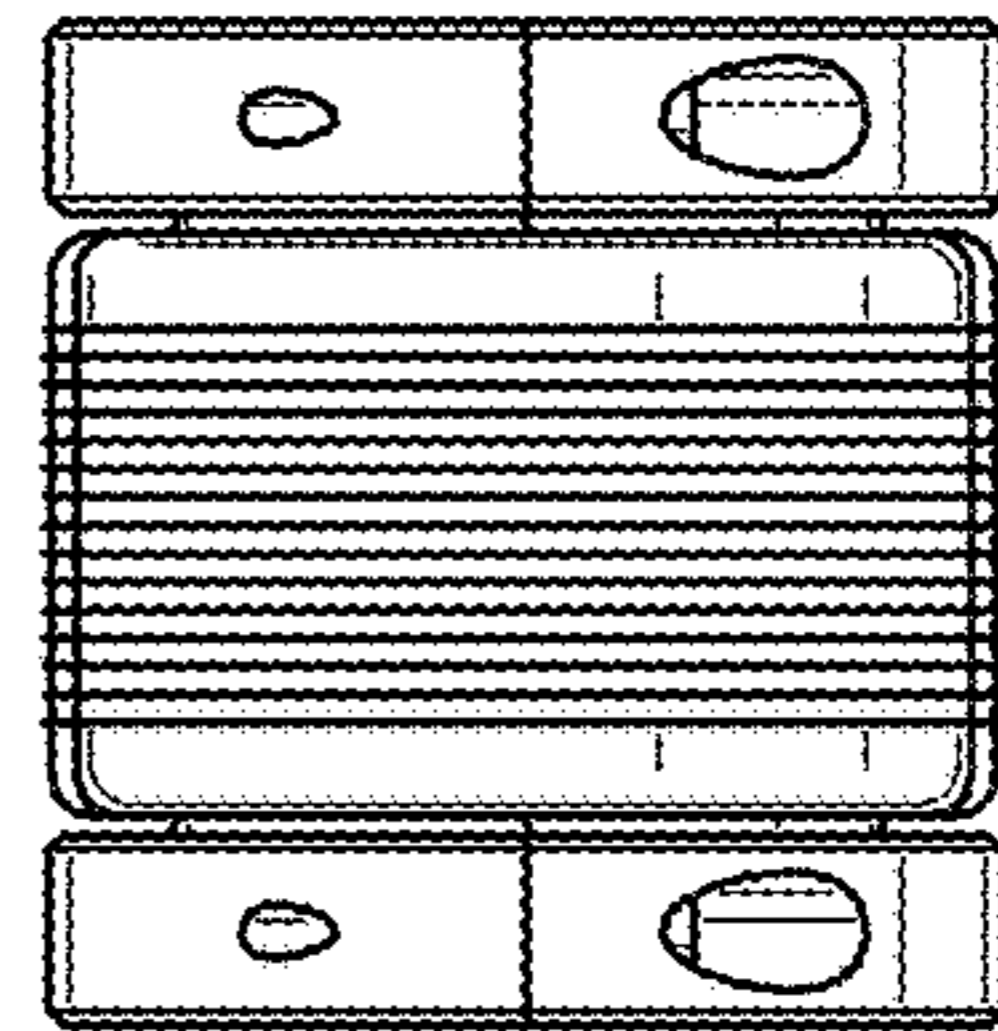

Fig. 7

