



US00D796335S

(12) **United States Design Patent**
Sabherwal

(10) **Patent No.:** **US D796,335 S**
(45) **Date of Patent:** **** Sep. 5, 2017**

(54) **CONTAINER**

(71) Applicant: **GlaxoSmithKline Consumer Healthcare Holdings (US) LLC**,
Wilmington, DE (US)

(72) Inventor: **Amit Sabherwal**, Gurgaon (IN)

(73) Assignee: **GlaxoSmithKline Consumer Healthcare Holdings (US) LLC**,
Wilmington, DE (US)

(**) Term: **15 Years**

(21) Appl. No.: **29/542,269**

(22) Filed: **Oct. 13, 2015**

(30) **Foreign Application Priority Data**

Apr. 13, 2015 (IN) 271339

(51) **LOC (10) Cl.** **09-01**

(52) **U.S. Cl.**
USPC **D9/552**

(58) **Field of Classification Search**
USPC D9/516, 530, 537, 540, 548, 549, 550,
D9/552, 557, 575; 132/293;
215/381-385, 396, 398; 220/296, 288,
220/300, 669, 675
CPC B65D 1/00; B65D 1/02; B65D 1/0223;
B65D 1/0246; B65D 41/00; B65D 41/02;
B65D 41/04; B65D 2501/00; B65D
2501/0009
See application file for complete search history.

(56) **References Cited**

U.S. PATENT DOCUMENTS

- 2,540,007 A * 1/1951 Pasotti B65D 41/02
215/352
- D191,181 S * 8/1961 Braun D9/529
- D210,570 S * 3/1968 Campbell D9/502
- D274,887 S * 7/1984 Ryder D9/453
- D348,395 S * 7/1994 Bertolini D9/529

(Continued)

OTHER PUBLICATIONS

BlenderBottle ProStak Twist n' Lock Storage Jars, announced May 2014, [online], site visited Nov. 28, 2016. Available from Internet, <URL: <http://www.amazon.com>>.*

Primary Examiner — Derrick Holland

Assistant Examiner — Janice Lim

(74) *Attorney, Agent, or Firm* — Nora L. Stein

(57) **CLAIM**

The ornamental design for a container, as shown and described.

DESCRIPTION

FIG. 1 is a perspective view of embodiment one, of a container, showing my new design;
 FIG. 2 is a back view thereof;
 FIG. 3 is a front view thereof;
 FIG. 4 is a right side view thereof;
 FIG. 5 is a left side view thereof;
 FIG. 6 is a top plan view thereof;
 FIG. 7 is a bottom plan view thereof;
 FIG. 8 is a perspective view of embodiment two, of a container, showing my new design;
 FIG. 9 is a back view thereof;
 FIG. 10 is a partially enlarged back view thereof, taken from FIG. 9;
 FIG. 11 is a front view thereof;
 FIG. 12 is a right side view thereof;
 FIG. 13 is a left side view thereof;
 FIG. 14 is a top plan view thereof; and,
 FIG. 15 is a bottom plan view thereof.
 The broken line portions show unclaimed subject matter and form no part of the claimed design.
 The broken line portions of FIG. 9 and FIG. 10 are included to show partially enlarged views only and form no part of the claimed design.

1 Claim, 15 Drawing Sheets

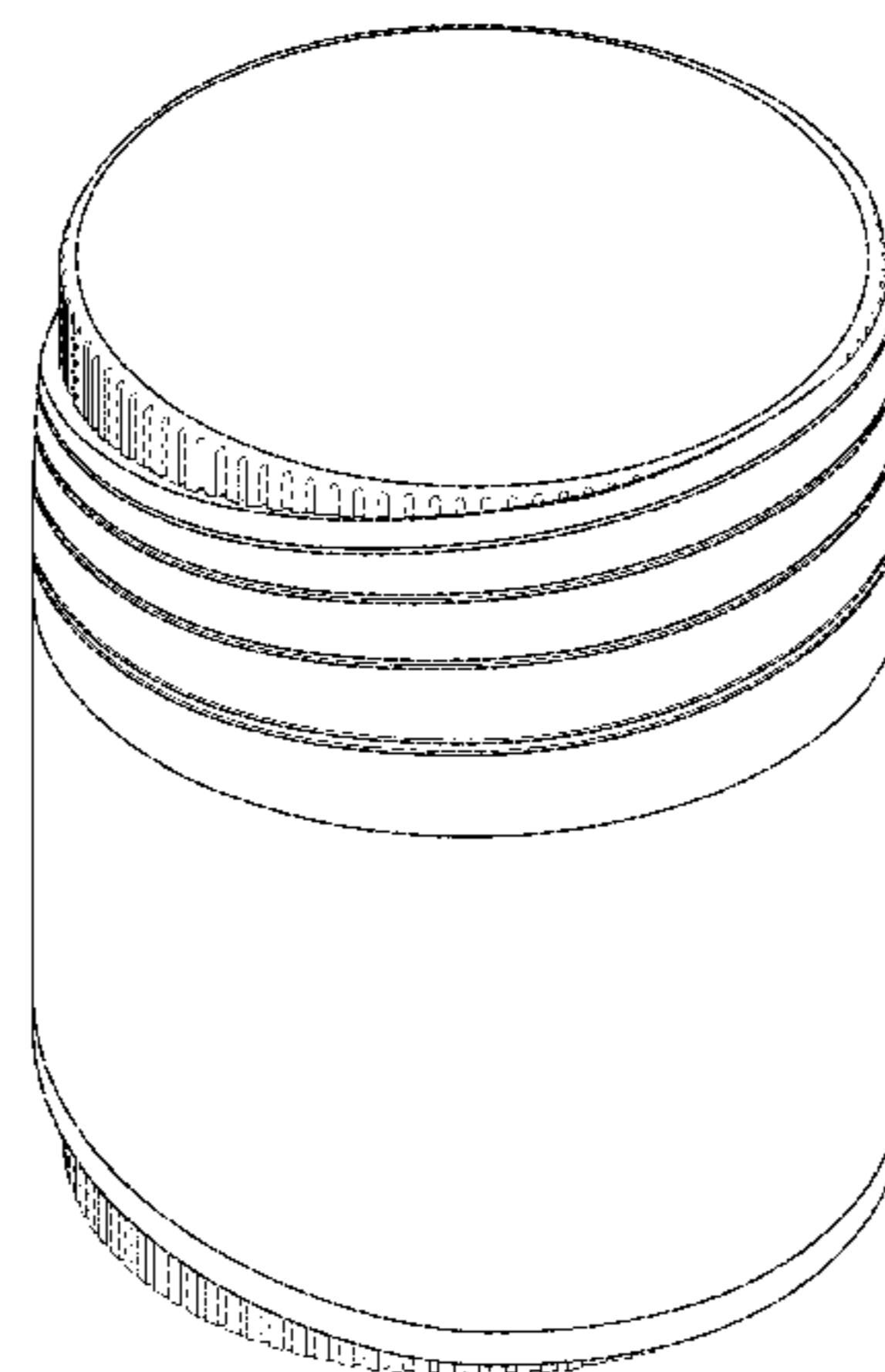
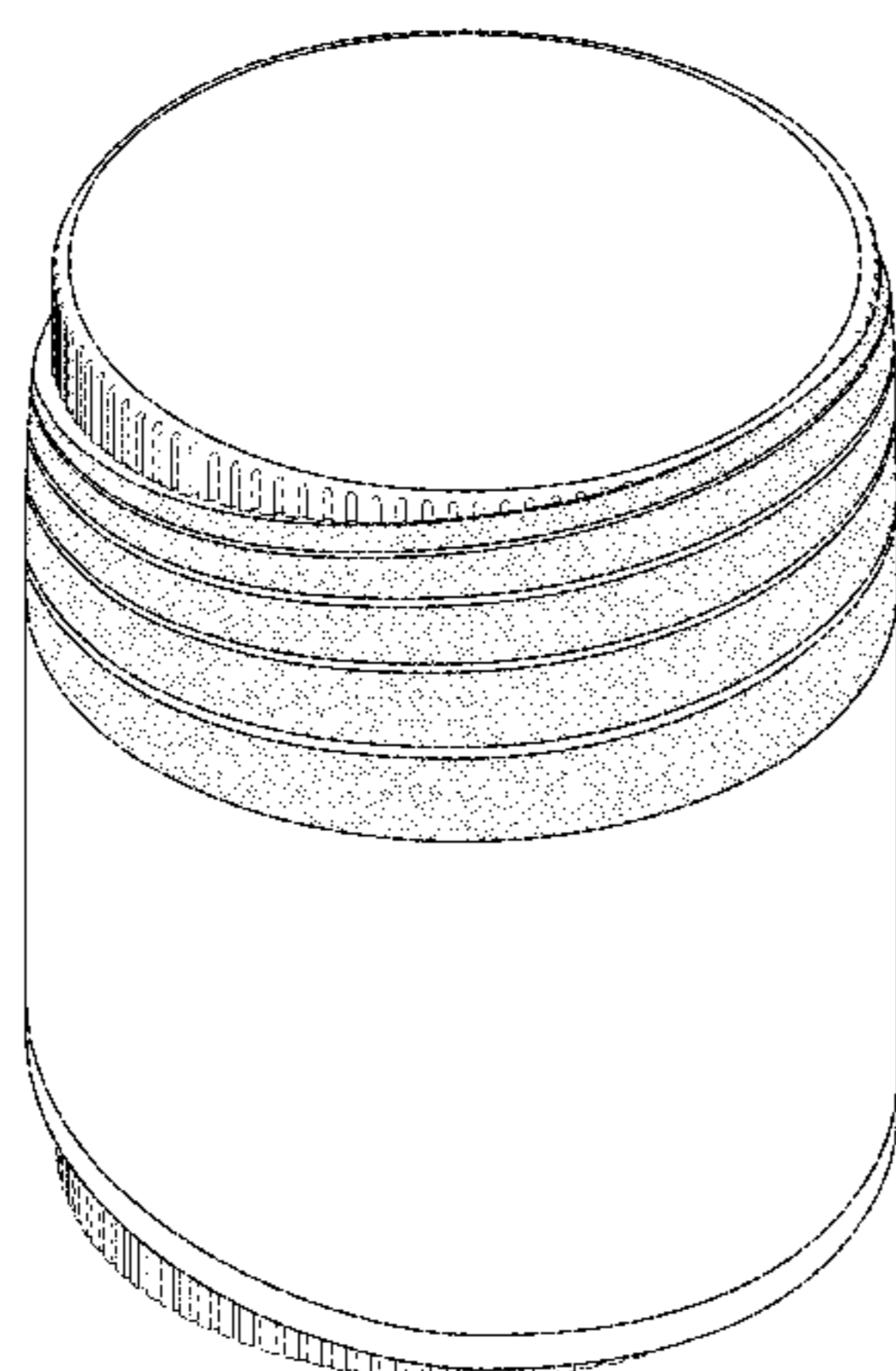

(56)

References Cited

U.S. PATENT DOCUMENTS

D359,910 S *	7/1995	Hirsch	D9/503
D408,292 S *	4/1999	Gundlach	D9/503
D543,457 S *	5/2007	Ben-Shlomo	D9/503
D572,136 S *	7/2008	Boni	D9/503
D588,011 S *	3/2009	Shimizu	D9/454
D675,926 S *	2/2013	Tovar	D9/537

* cited by examiner

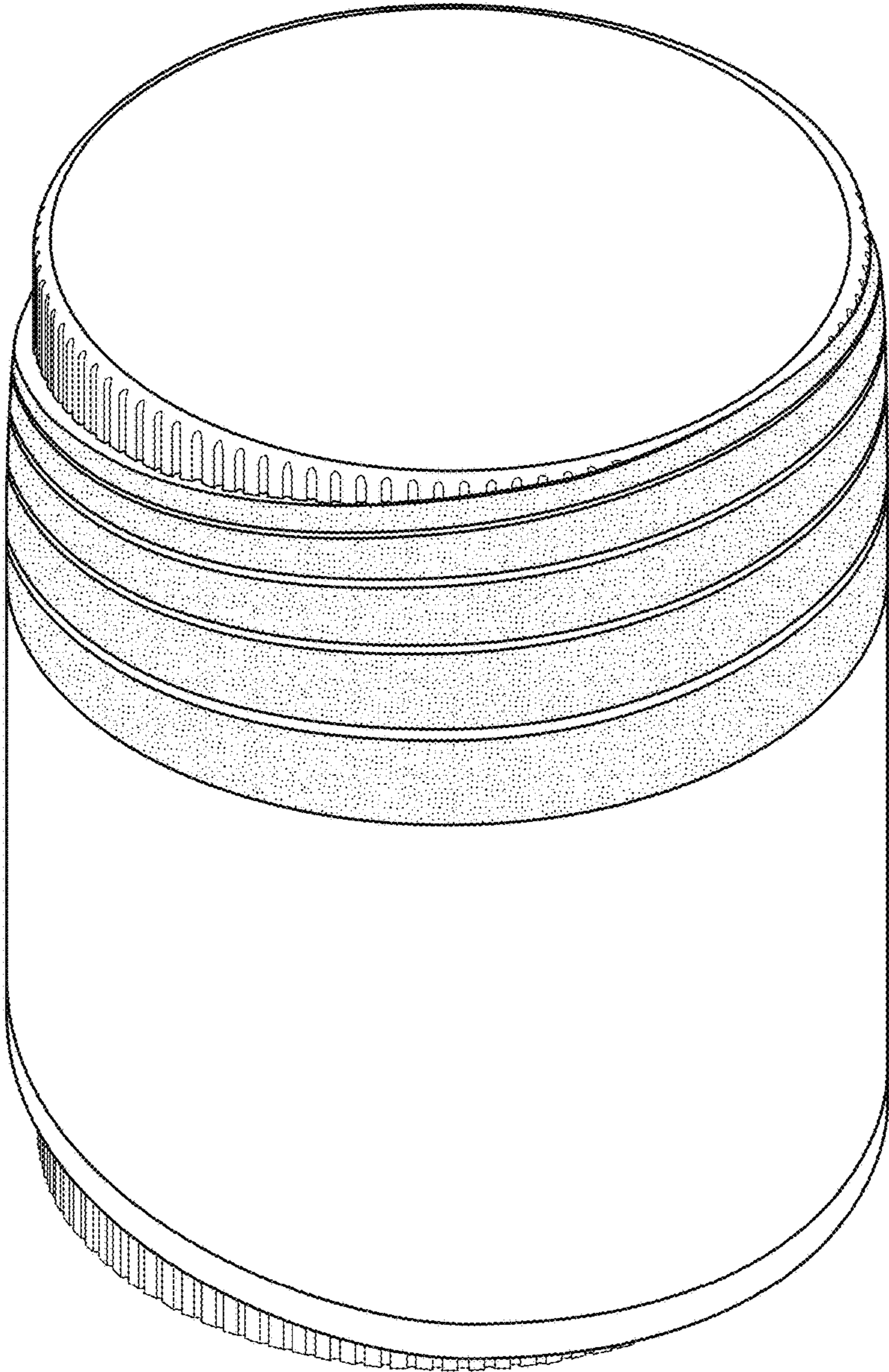

FIG. 1

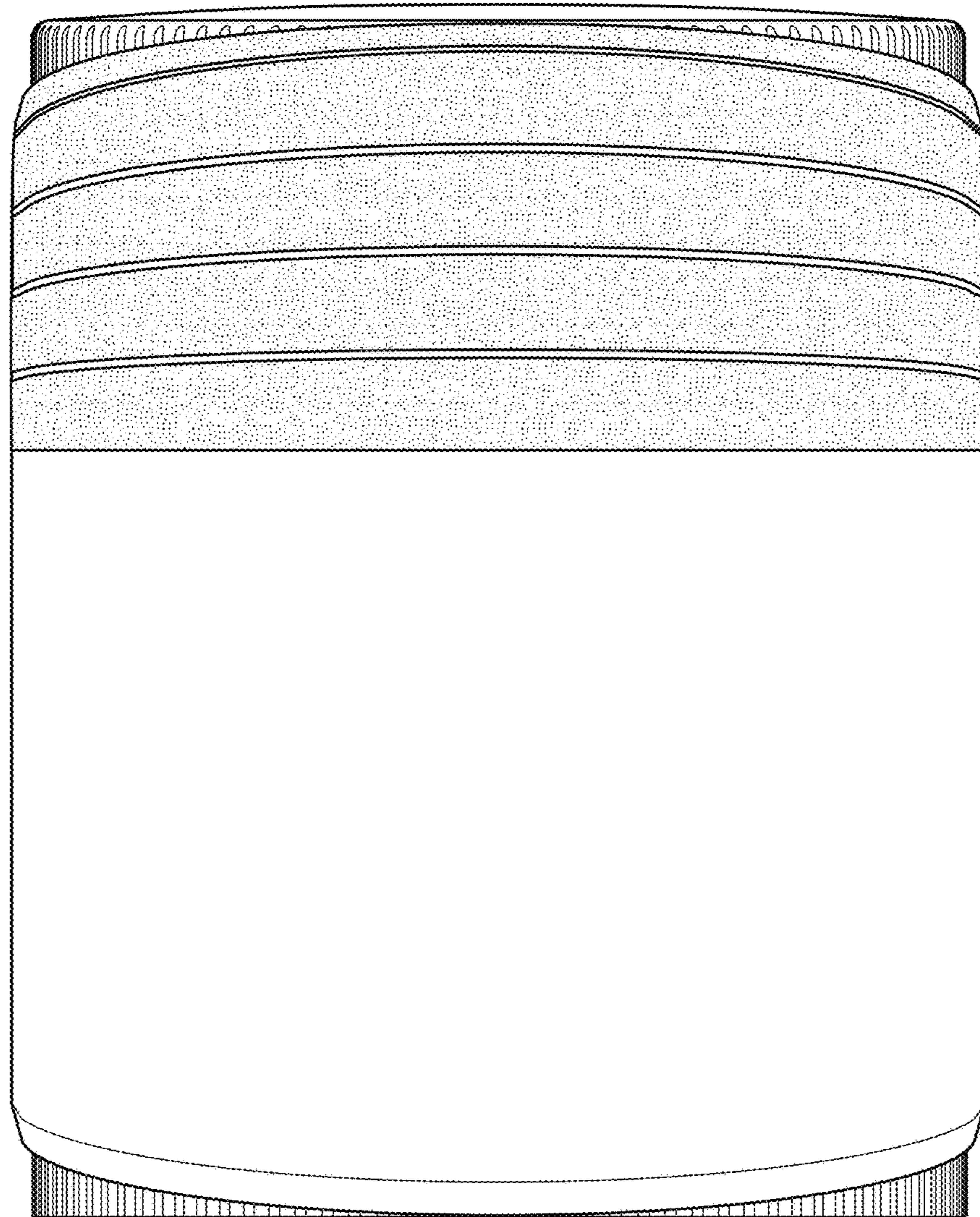

FIG. 2

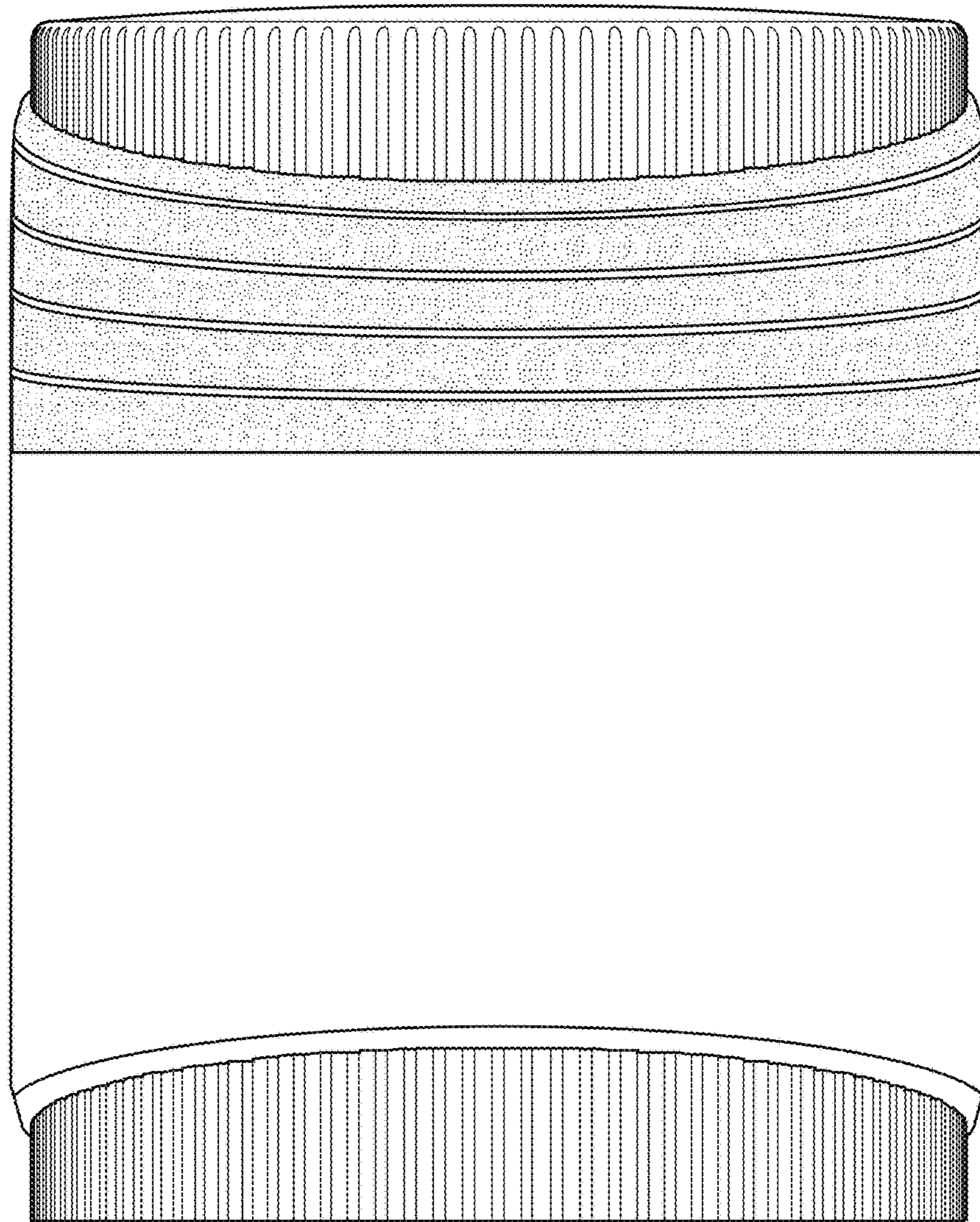

FIG. 3

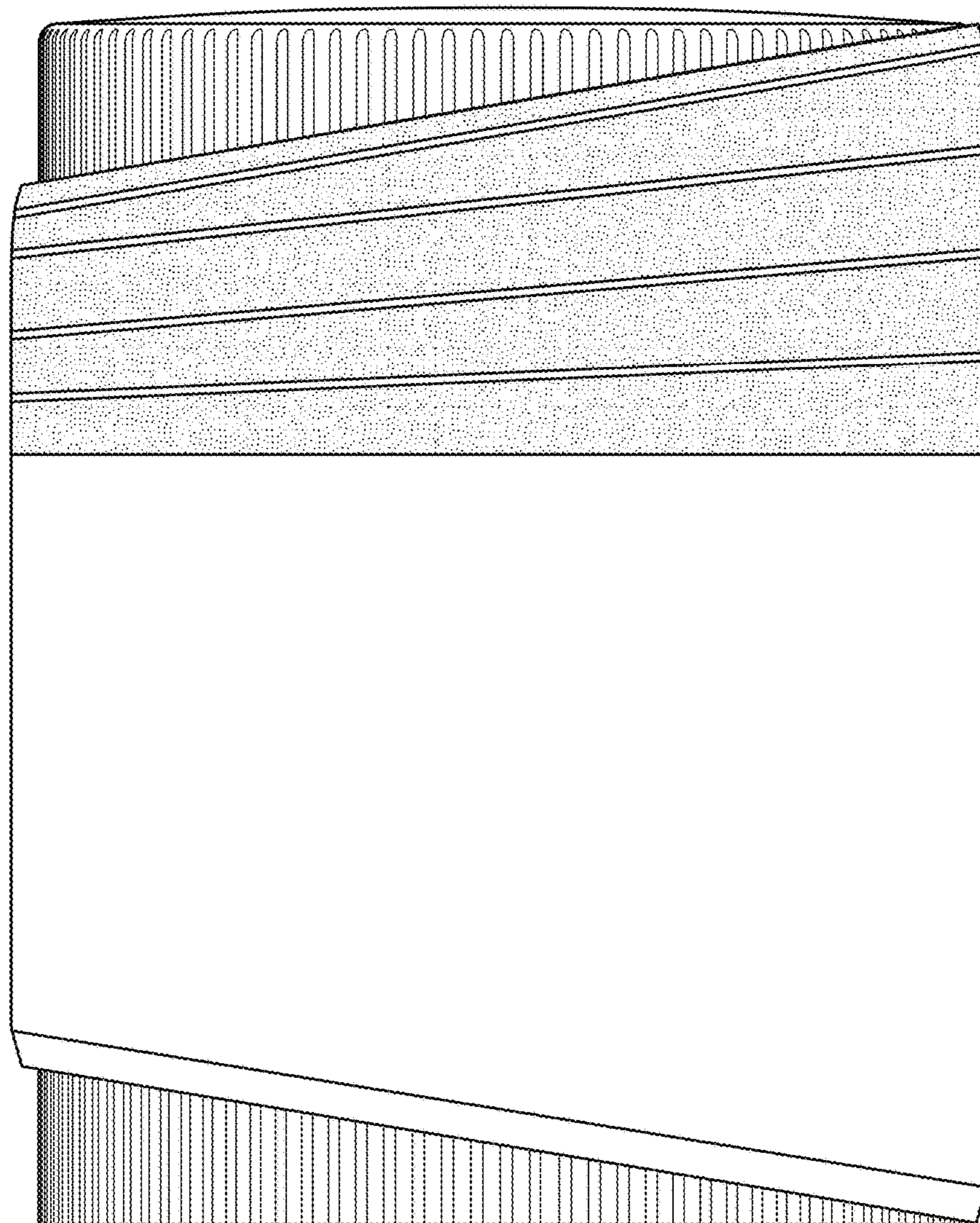

FIG. 4

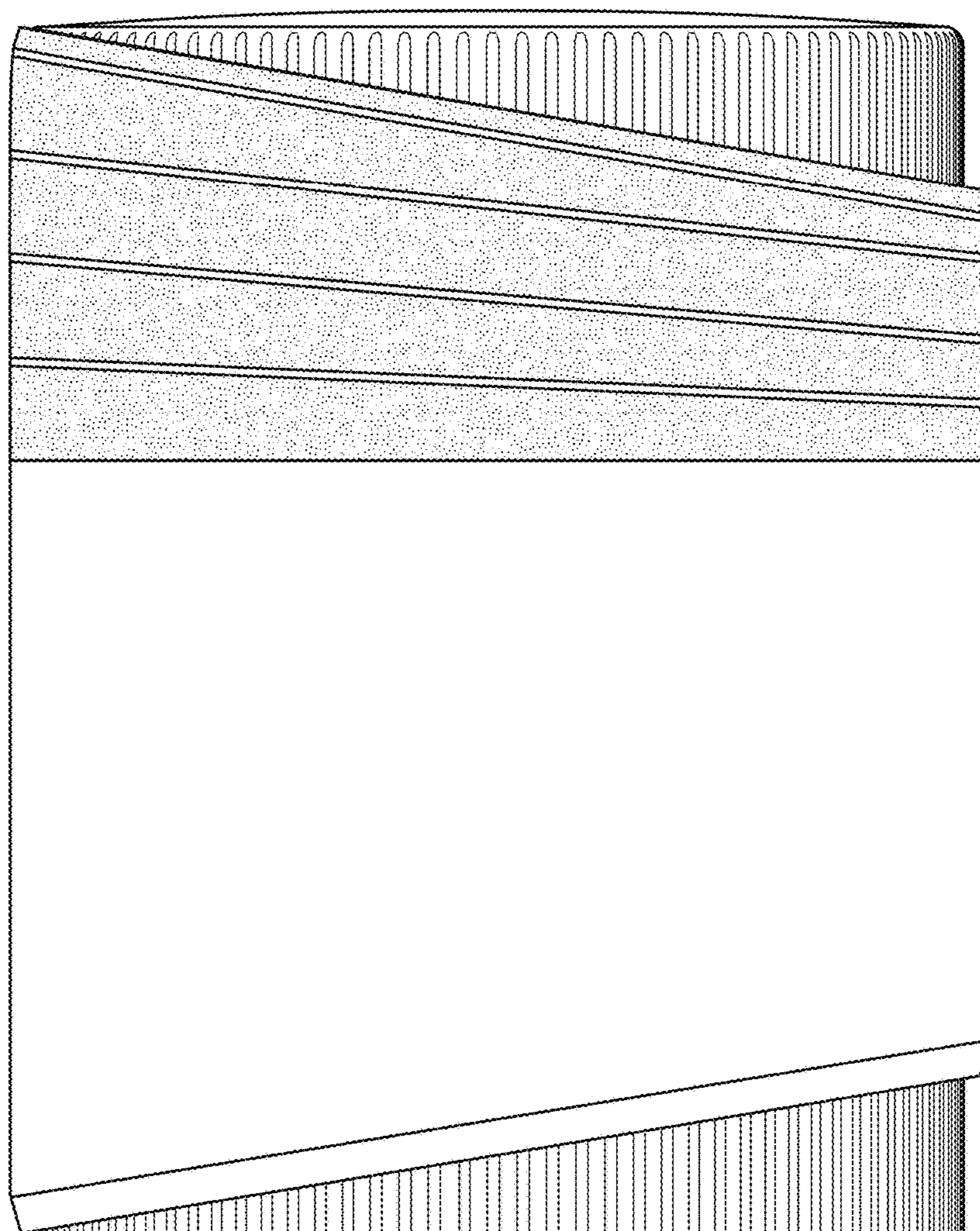

FIG. 5

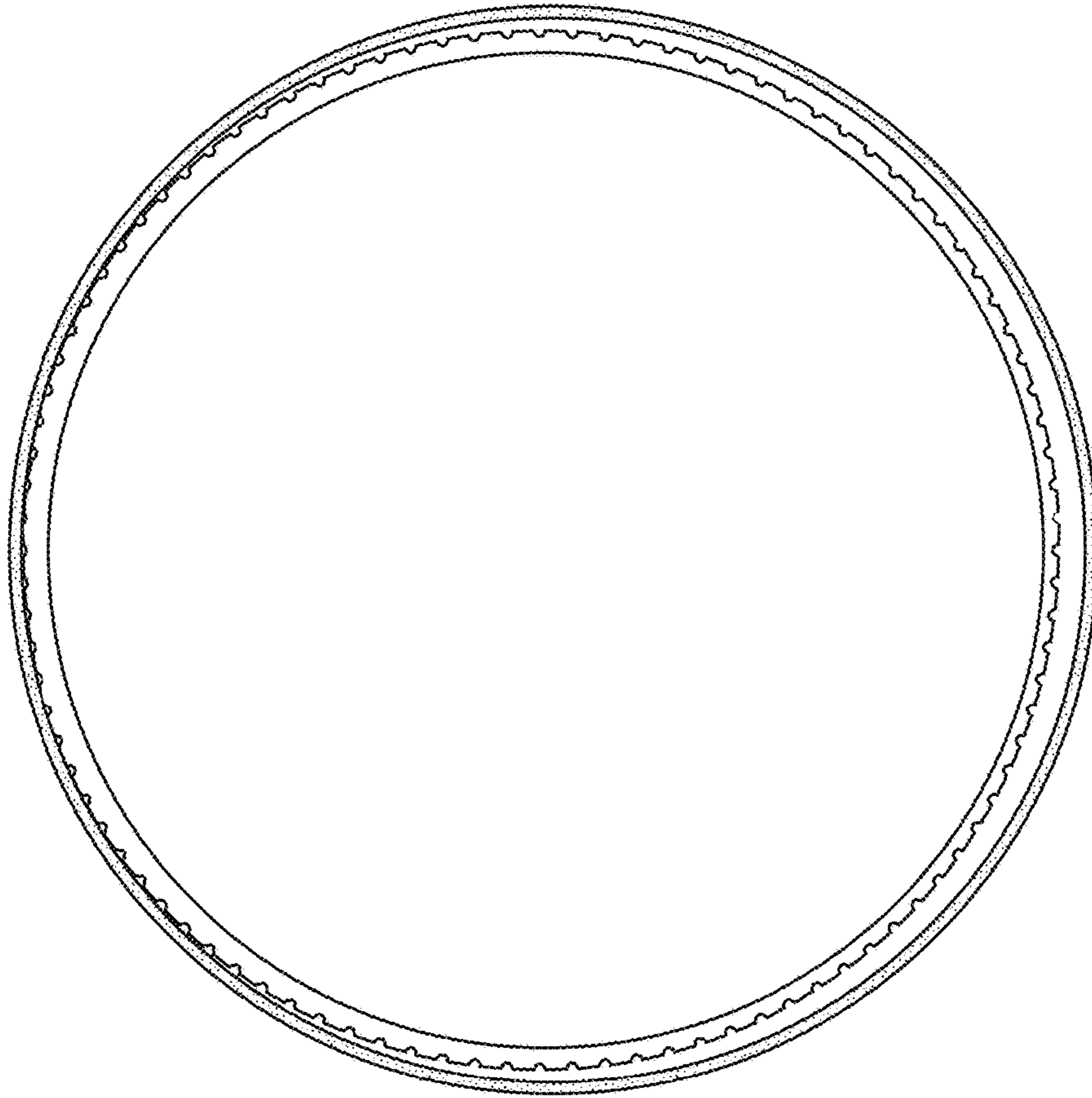

FIG. 6

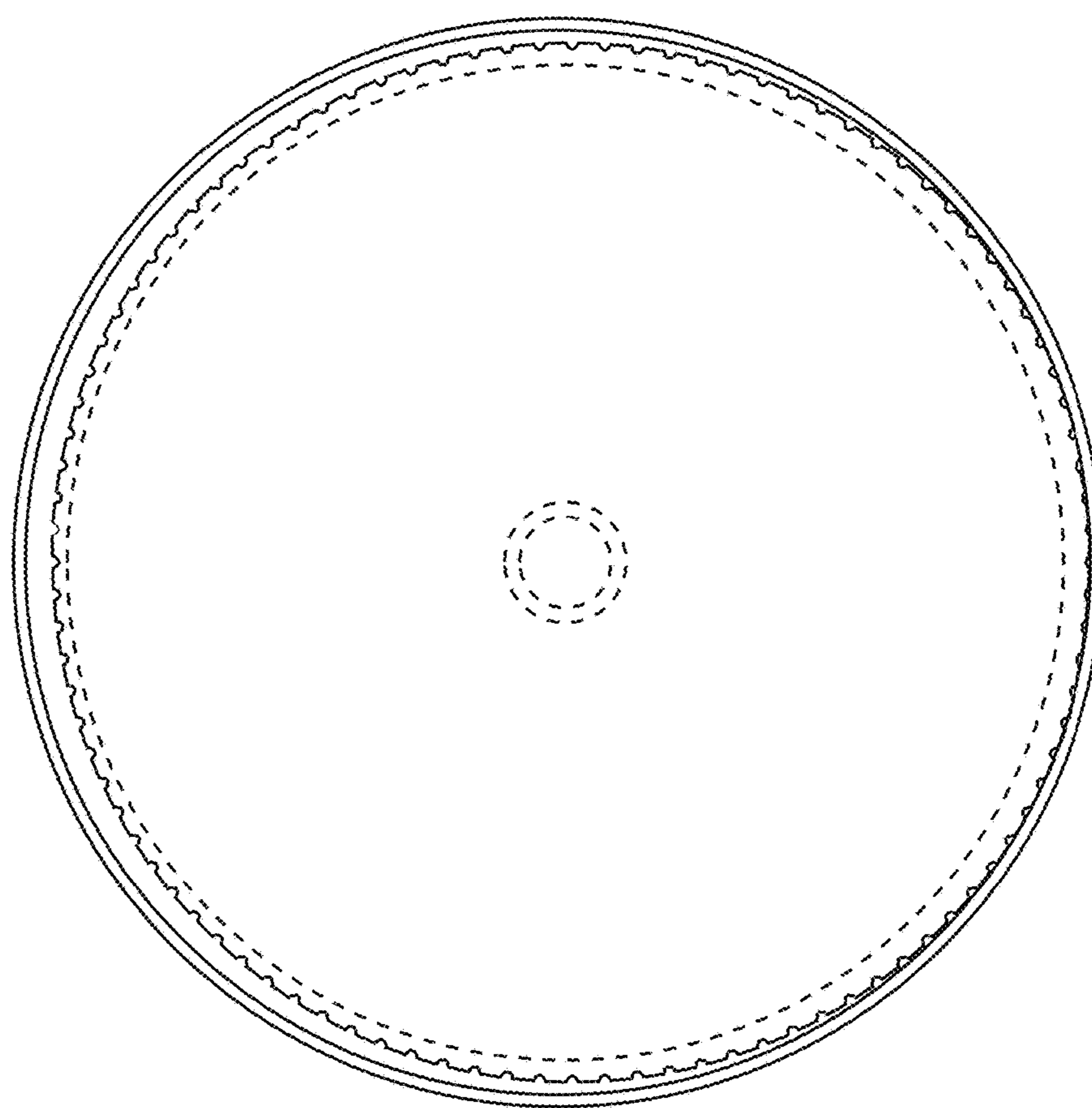

FIG. 7

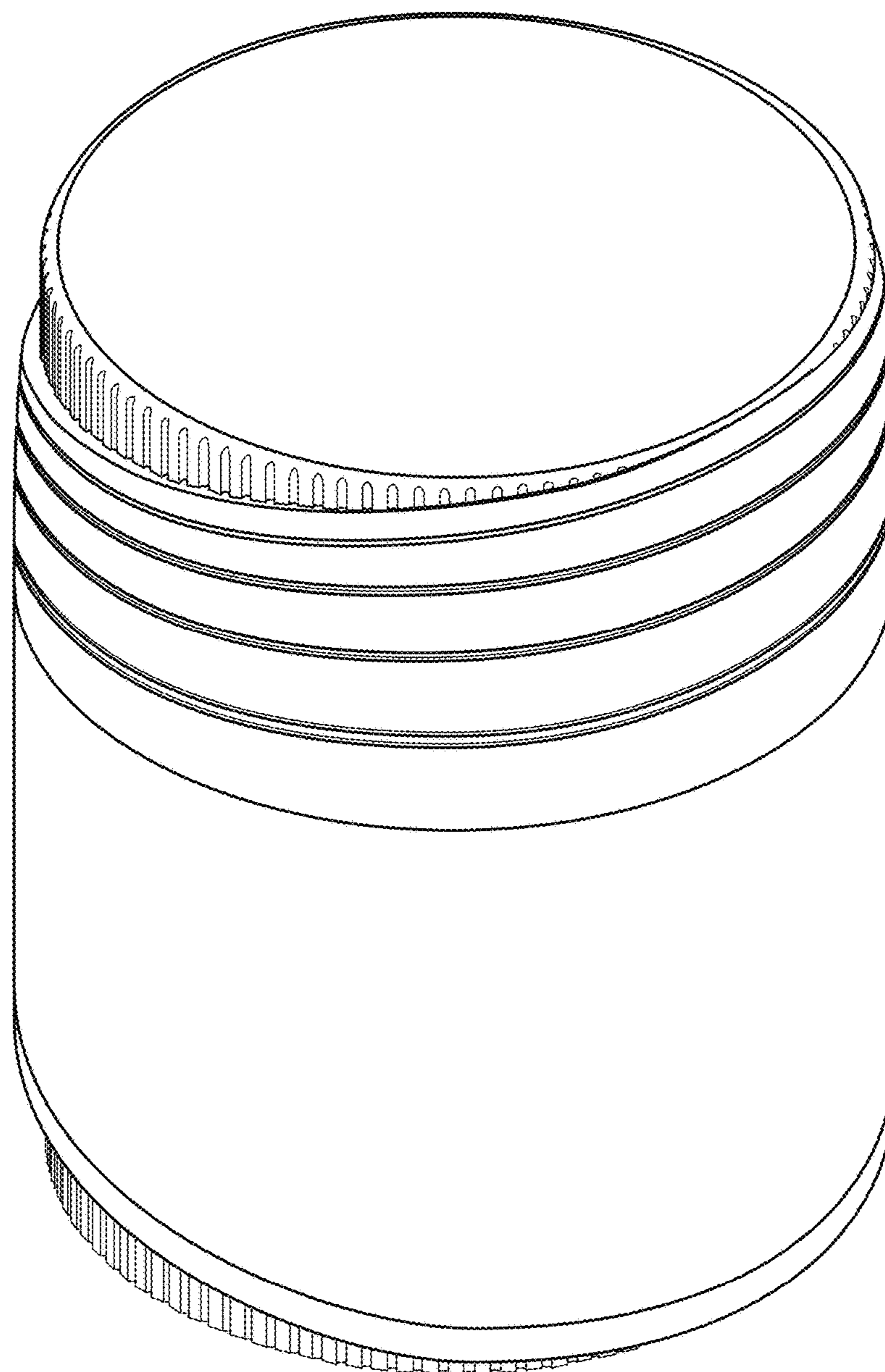

FIG. 8

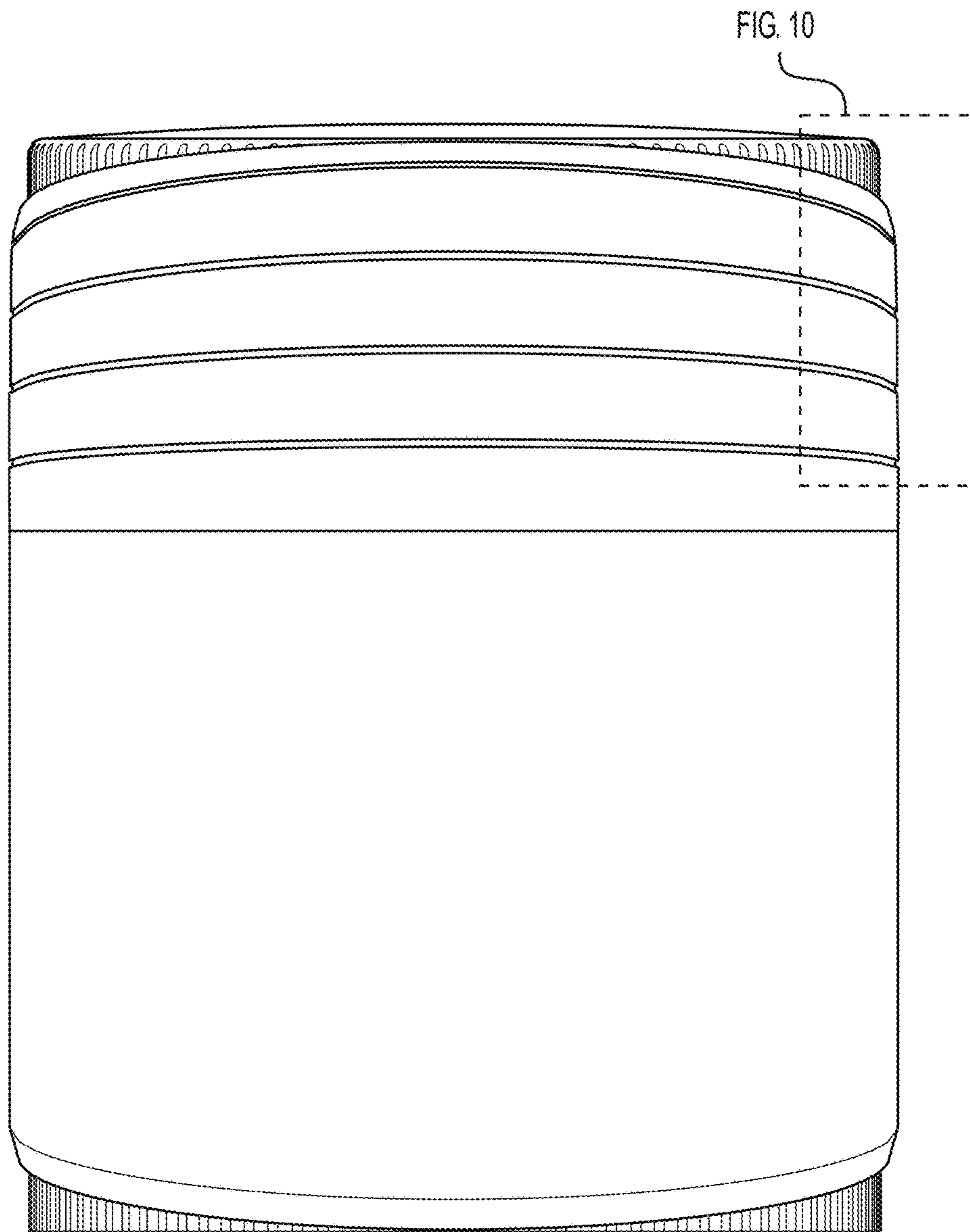

FIG. 9

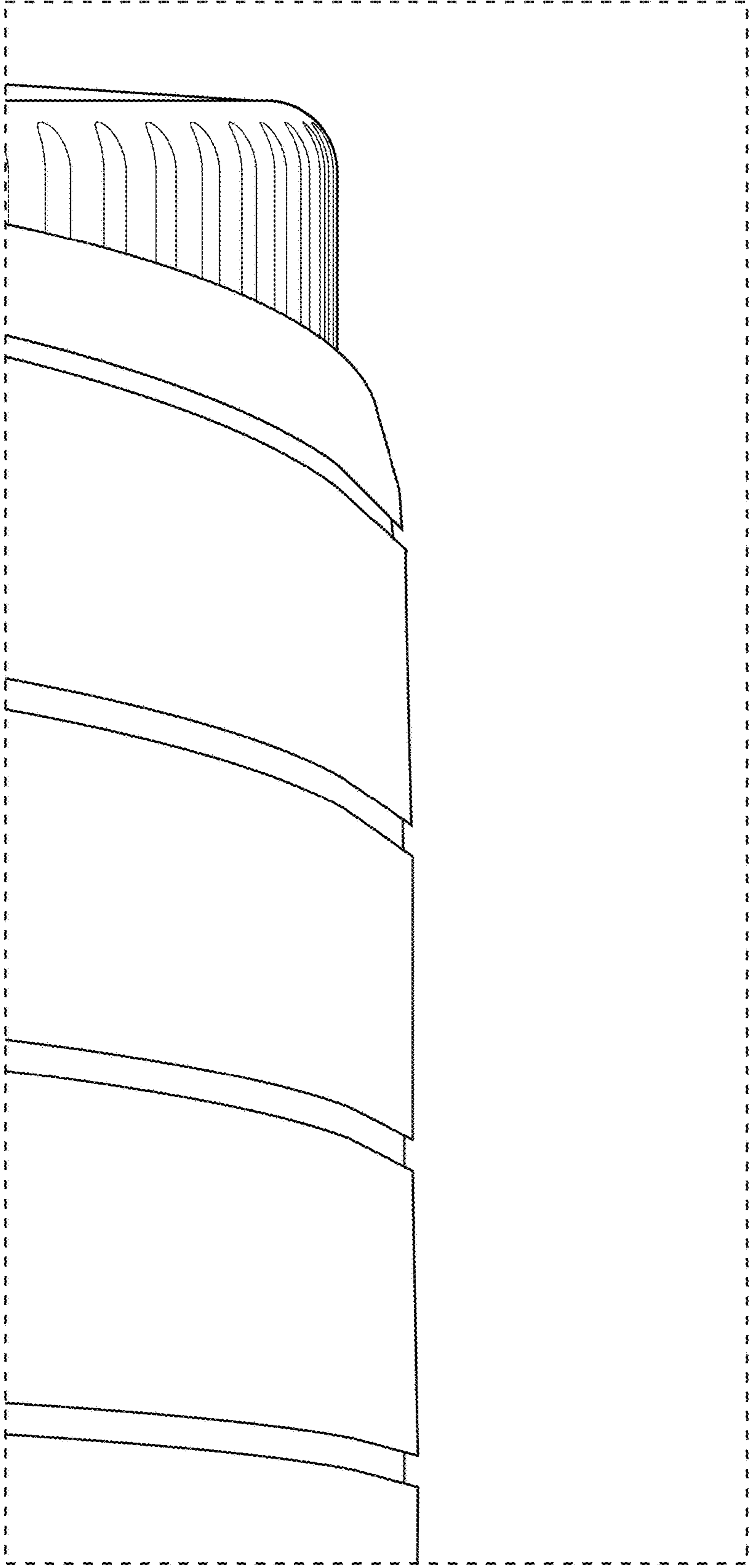

FIG. 10

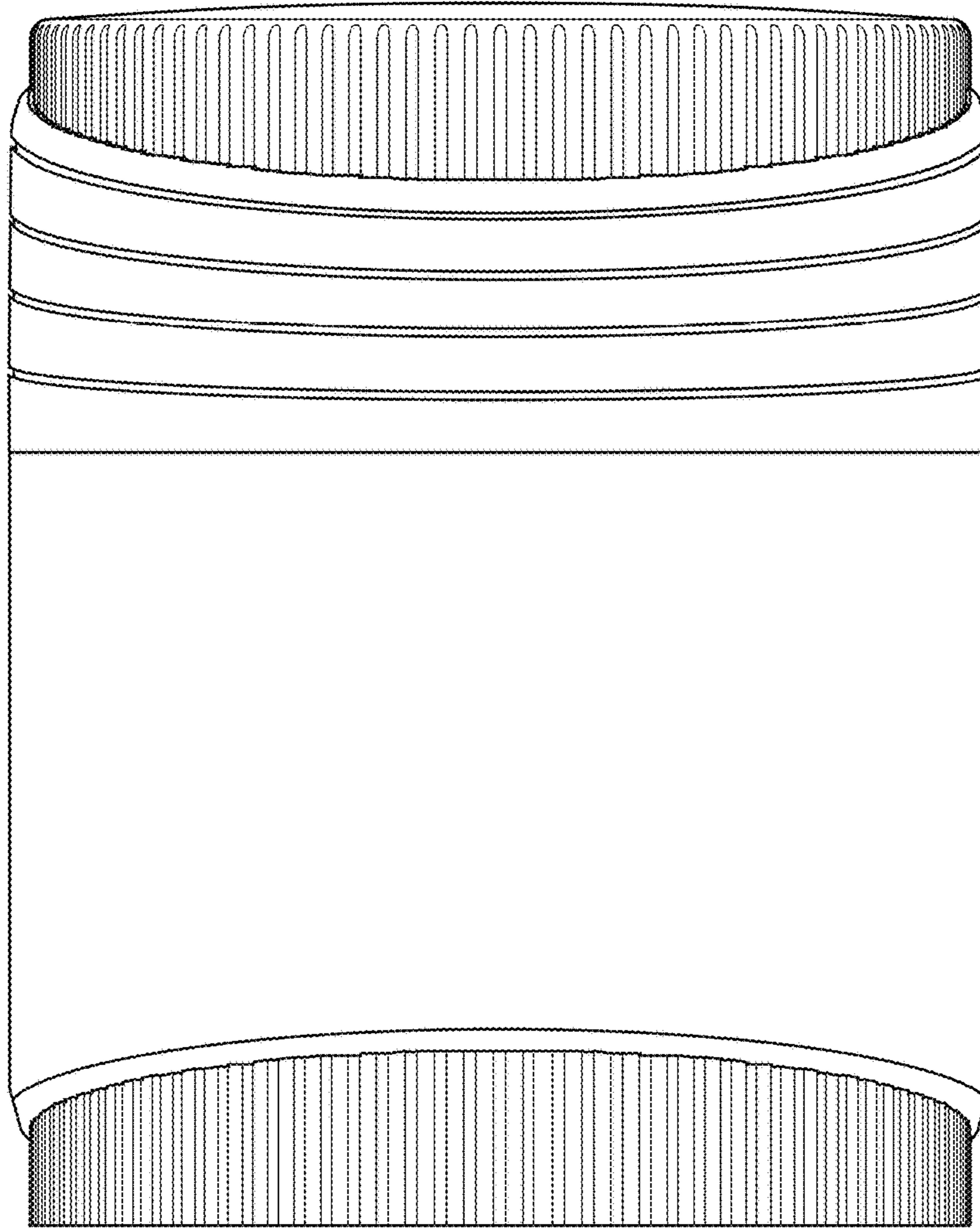

FIG. 11

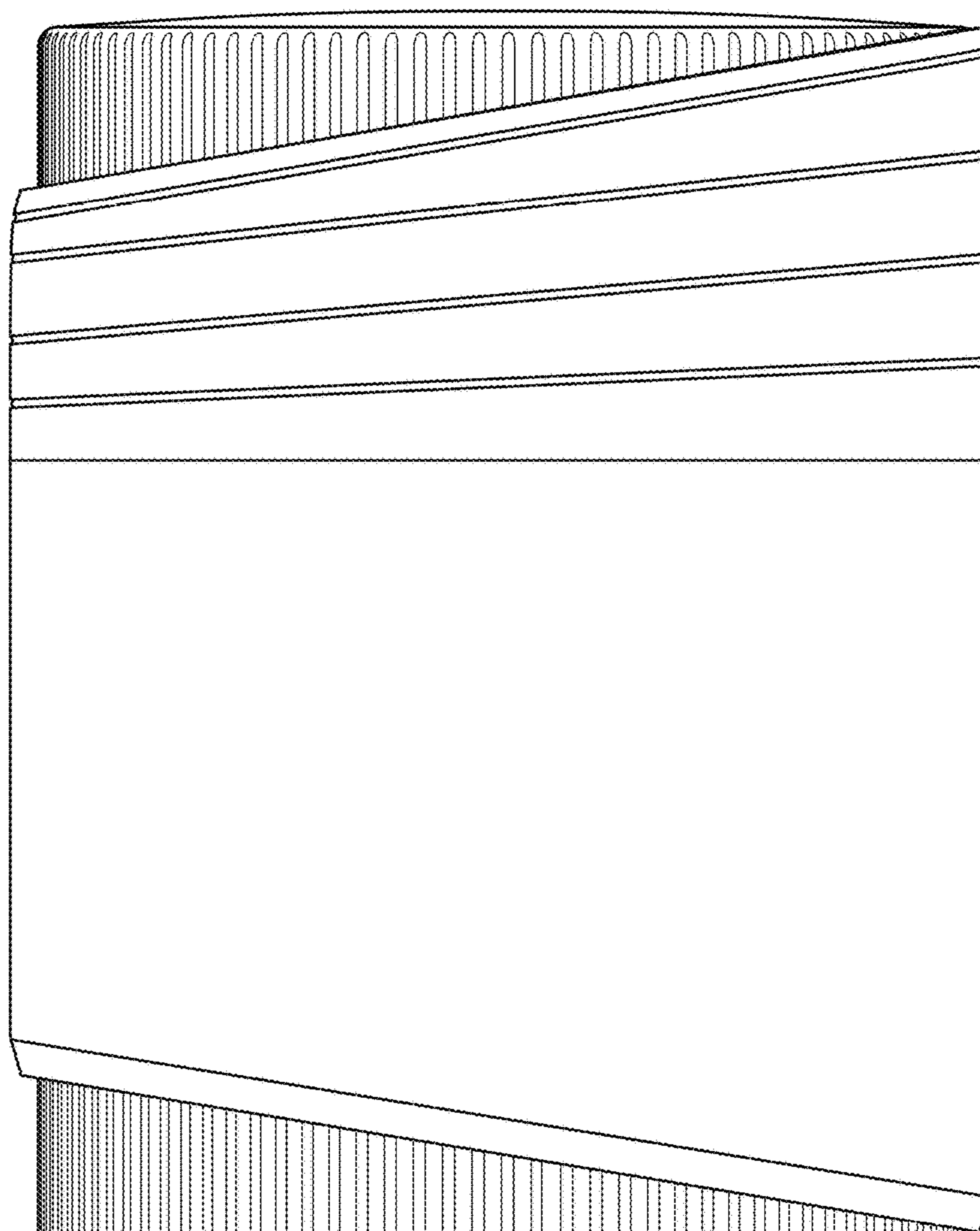

FIG. 12

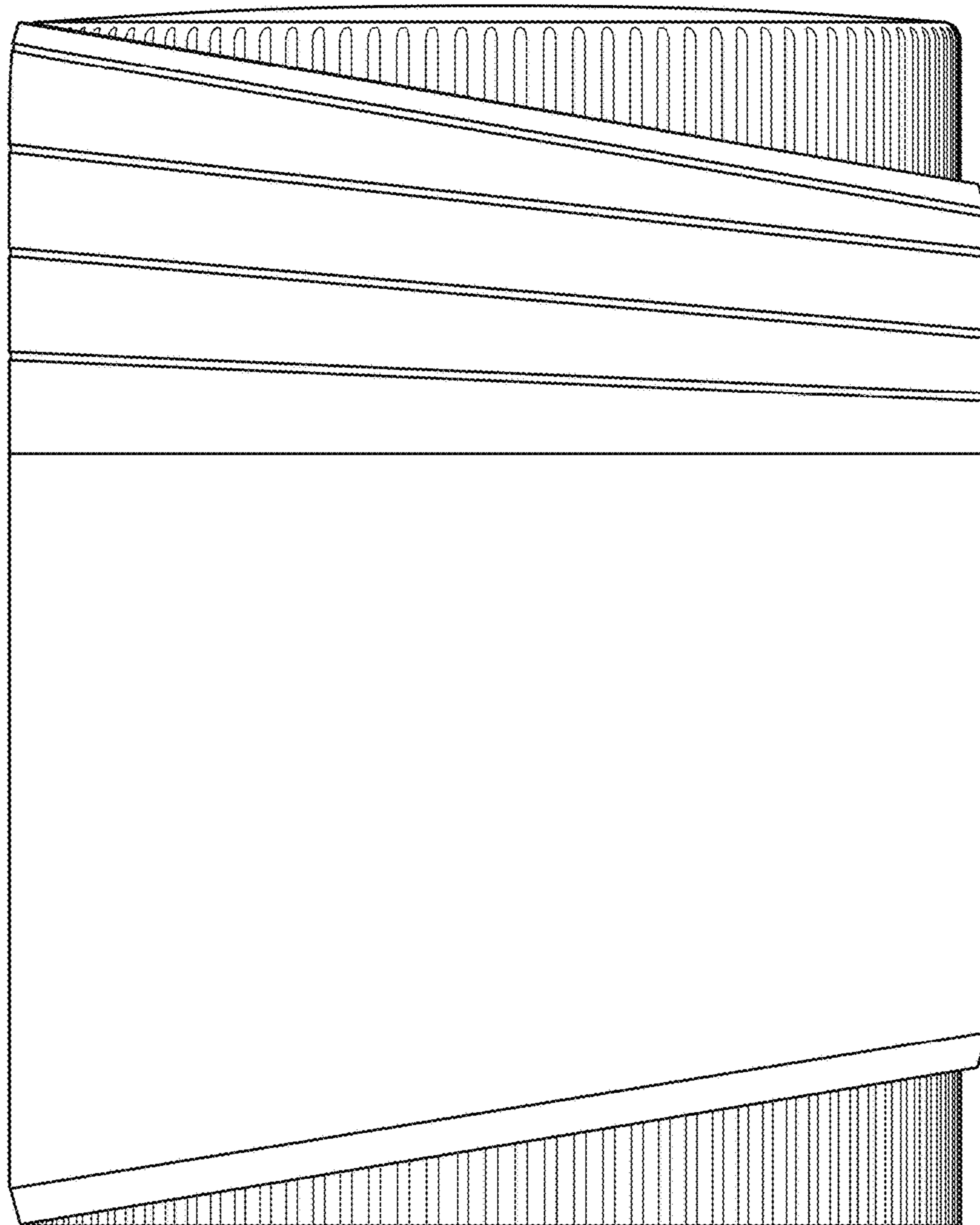

FIG. 13

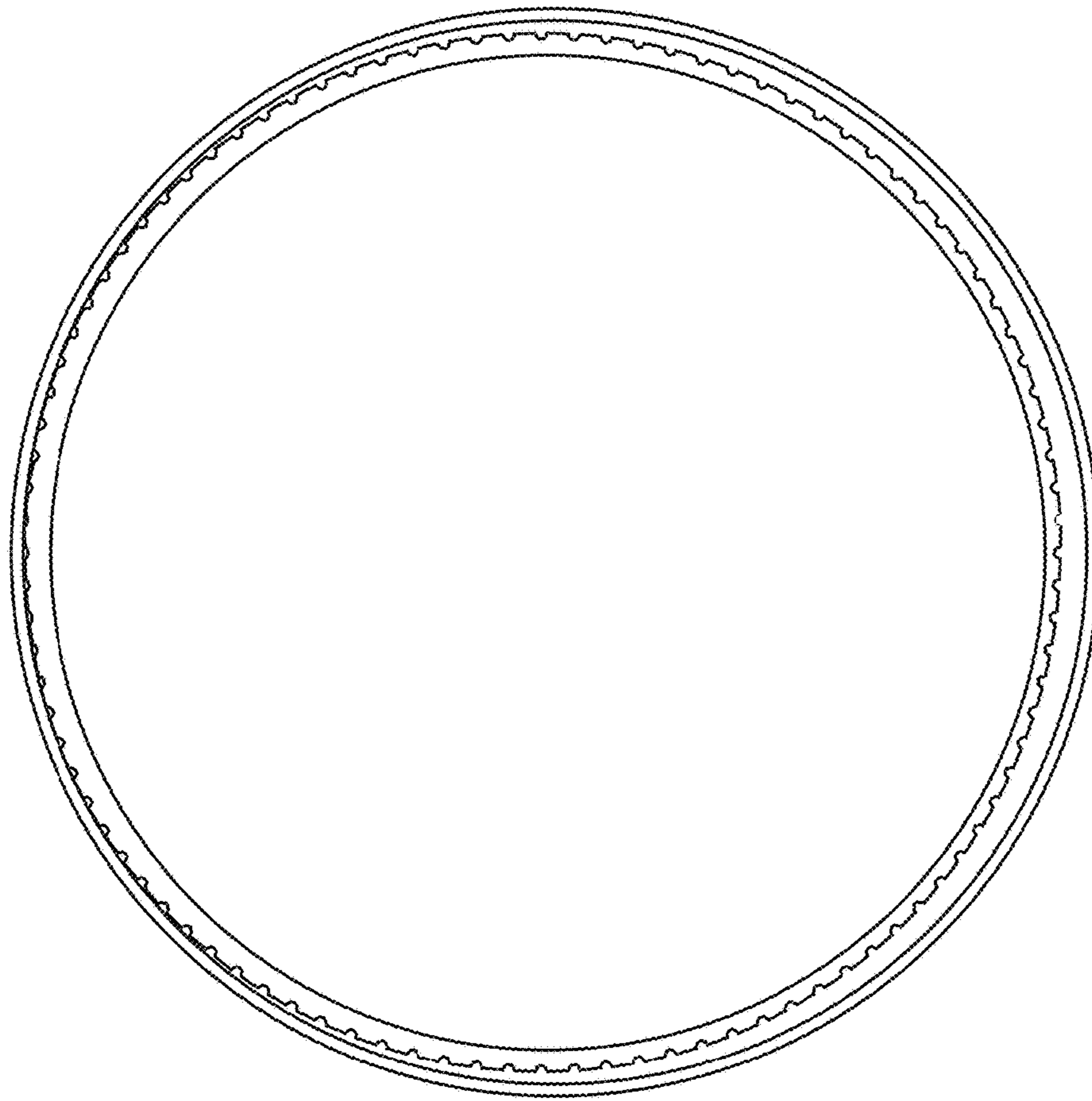

FIG. 14

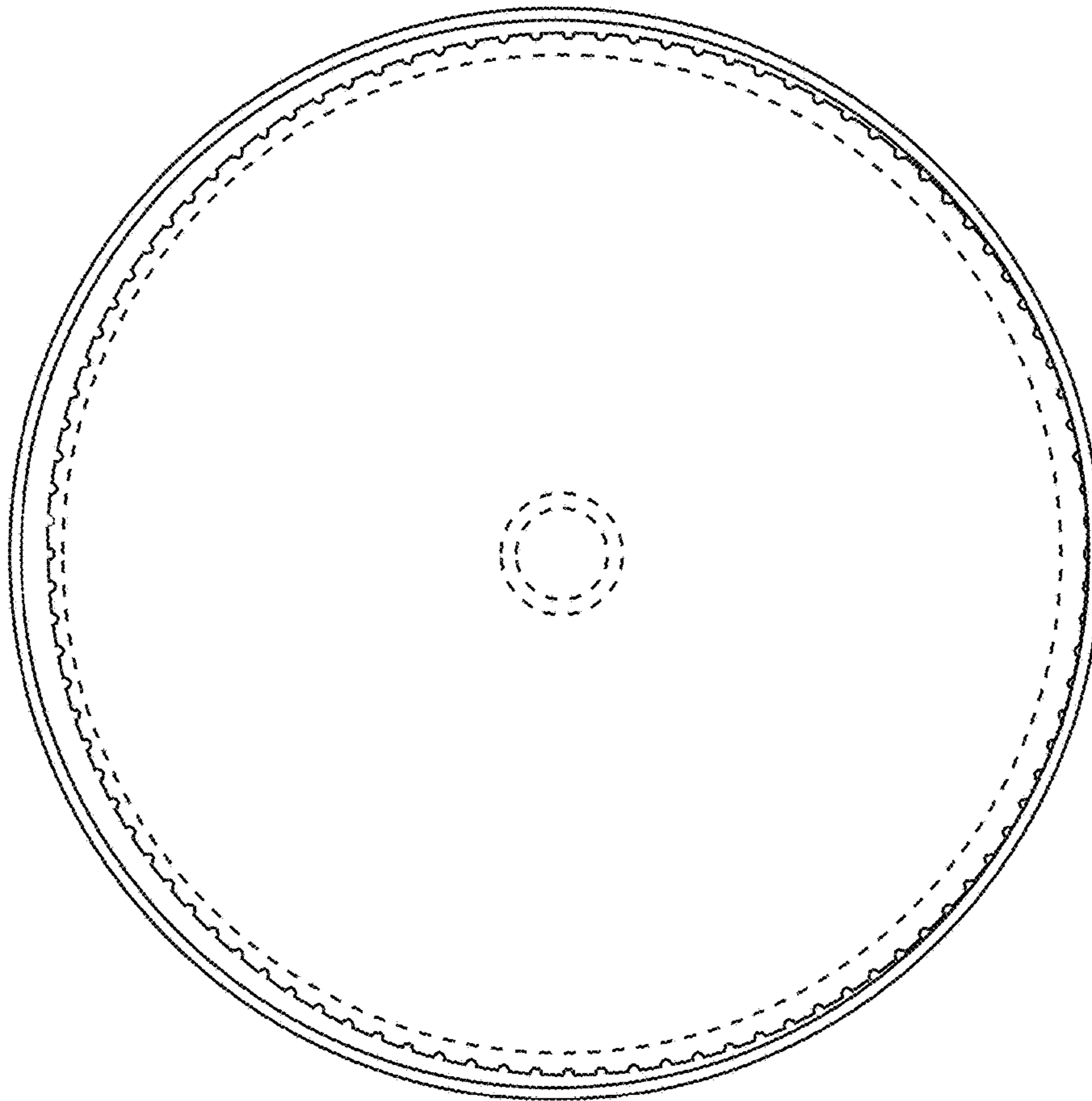

FIG. 15