



US00D796332S

(12) **United States Design Patent**  
**Guo et al.**

(10) **Patent No.:** **US D796,332 S**  
(45) **Date of Patent:** **\*\* Sep. 5, 2017**

(54) **BOTTLE**

(71) Applicant: **The Coca-Cola Company**, Atlanta, GA (US)

(72) Inventors: **Judy Guo**, San Francisco, CA (US);  
**Miguel Angel Cabra Apalategui**, San Francisco, CA (US); **Wilfred Kenneth Castillo**, San Francisco, CA (US);  
**Gerald Reid Harris**, Pacifica, CA (US); **Ricardo Filipe Figueiroa Monteiro**, San Francisco, CA (US);  
**Sterling Lane Steward**, Douglasville, GA (US)

(73) Assignee: **THE COCA-COLA COMPANY**, Atlanta, GA (US)

(\*\*) Term: **14 Years**

(21) Appl. No.: **29/436,363**

(22) Filed: **Nov. 5, 2012**

(51) **LOC (10) Cl.** ..... **09-01**

(52) **U.S. Cl.**  
USPC ..... **D9/538**; D9/551

(58) **Field of Classification Search**  
USPC ..... D9/500, 502-505, 516, 520, 530,  
D9/537-545, 548-550, 551, 554,  
(Continued)

(56) **References Cited**

U.S. PATENT DOCUMENTS

D166,595 S \* 4/1952 Du Pree ..... D7/300  
D193,033 S \* 6/1962 Waser ..... D9/538  
(Continued)

*Primary Examiner* — Dana L Meyrow

(74) *Attorney, Agent, or Firm* — McAndrews, Held & Malloy, Ltd.

(57) **CLAIM**

The ornamental design for a bottle, as shown and described.

**DESCRIPTION**

FIG. 1 is a perspective view of a first embodiment of a bottle showing our new design;  
FIG. 2 is a top plan view thereof;  
FIG. 3 is a bottom plan view thereof;  
FIG. 4 is a front elevation view thereof;  
FIG. 5 is a rear elevation view thereof;  
FIG. 6 is a right-side elevation view thereof;  
FIG. 7 is a left-side elevation view thereof;  
FIG. 8 is an enlarged detail of the designated "FIG. 8" area shown in FIG. 4;  
FIG. 9 is a perspective view of a second embodiment of a bottle showing our new design;  
FIG. 10 is a top plan view thereof;  
FIG. 11 is a bottom plan view thereof;  
FIG. 12 is a front elevation view thereof;  
FIG. 13 is a rear elevation view thereof;  
FIG. 14 is a right-side elevation view thereof;  
FIG. 15 is a left-side elevation view thereof; and,  
FIG. 16 is an enlarged detail of the designated "FIG. 16" area shown in FIG. 12.

The evenly-dashed broken lines in the drawings illustrate portions of the bottle that form no part of the claim. The short dash-long dash (dot-dash) broken lines in the drawings define the bounds of the claim and form no part thereof. The short dash-short dash-long dash (dot-dot-dash) broken lines in the drawings delineate portions of the claimed design that are illustrated in enlargements and form no part of the claimed design.

The oblique line shading shown in Embodiment 2 (FIGS. 9-16) is used to denote that the claimed surfaces of the bottle are transparent; except in FIG. 9, the details of the opposing sides as seen through the claimed transparent surfaces of the bottle have not been shown for ease of illustration and understanding.

**1 Claim, 10 Drawing Sheets**

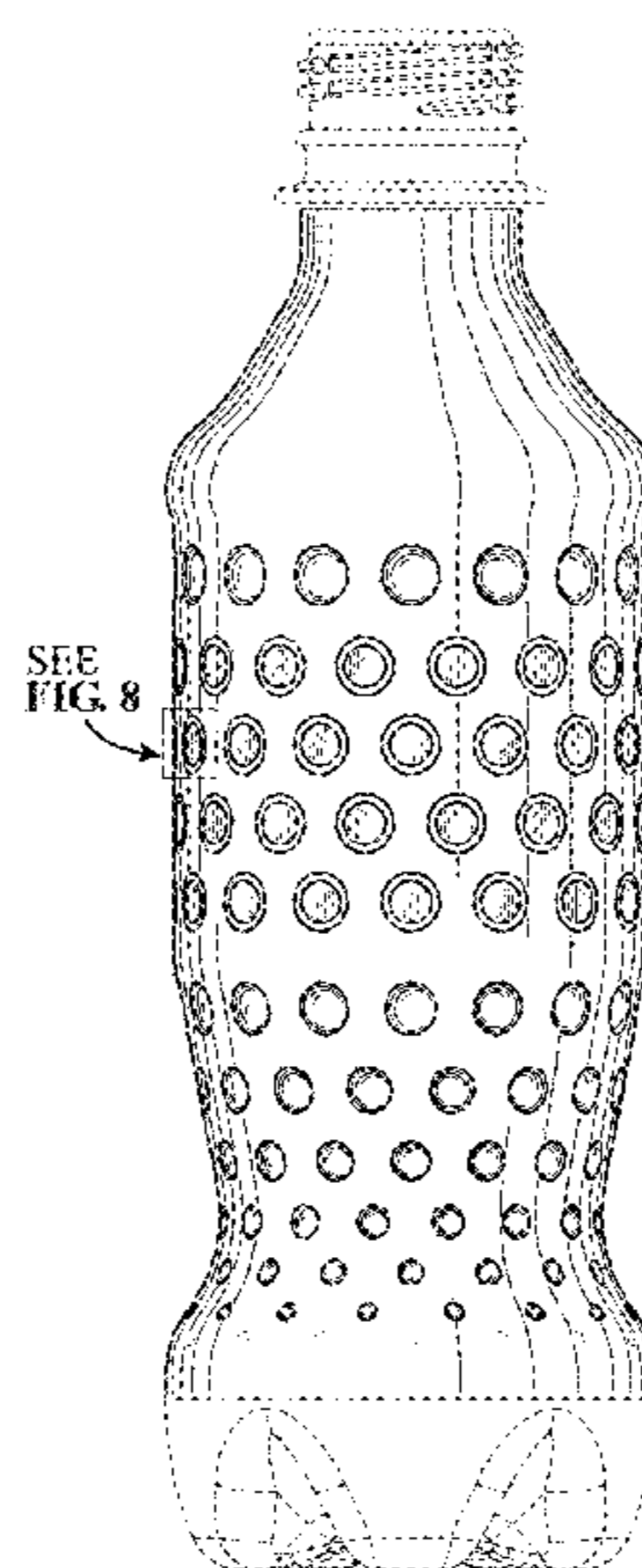
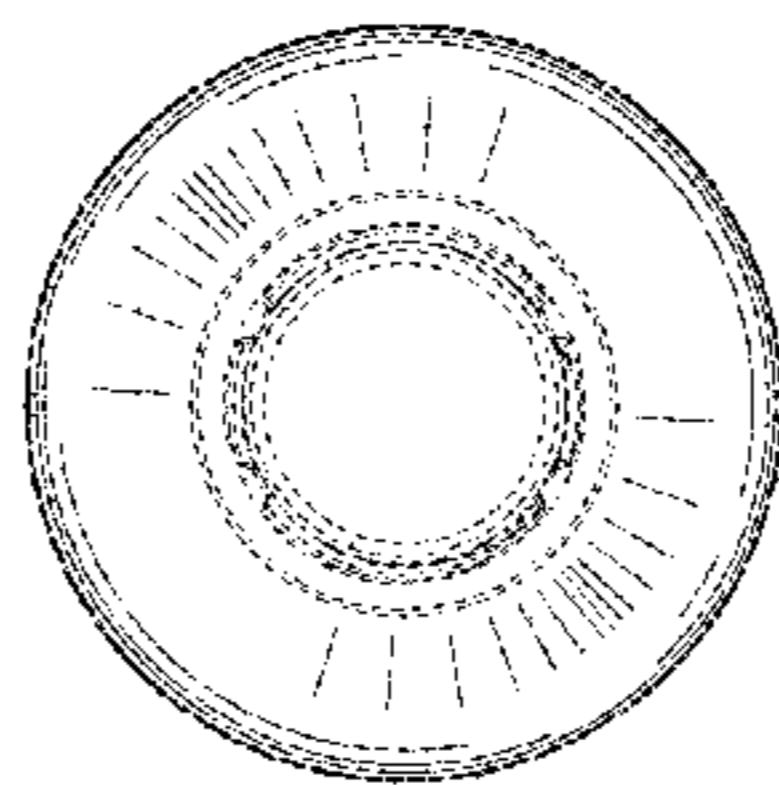

(58) **Field of Classification Search**

USPC ..... D9/558-559, 564, 715, 719; D24/197;  
215/11.1, 379, 381-384; 220/660, 669,  
220/675

CPC ..... B65D 1/00; B65D 1/02; B65D 1/0223;  
B65D 23/00; B65D 83/00; B65D 91/00;  
B65D 91/02; B65D 2501/00; B65D  
2501/0009

See application file for complete search history.

(56) **References Cited**

U.S. PATENT DOCUMENTS

D193,638	S	*	9/1962	Goldstein	.....	D9/538
D230,187	S	*	1/1974	Schultz	.....	D26/11
D329,019	S	*	9/1992	Olds et al.	.....	D9/551
D448,307	S	*	9/2001	Handler	.....	D9/564
D457,702	S	*	5/2002	Tropper	.....	D34/1
D469,699	S	*	2/2003	Crawford et al.	.....	D9/551
D471,112	S	*	3/2003	Davis et al.	.....	D9/551
D547,659	S	*	7/2007	Heisner	.....	D9/516
D563,230	S	*	3/2008	Watts	.....	D9/538
D563,231	S	*	3/2008	Watts	.....	D9/538
D612,101	S	*	3/2010	Enriquez	.....	D28/4
D612,539	S	*	3/2010	Enriquez	.....	D28/4
D612,987	S	*	3/2010	Enriquez	.....	D28/4
D612,988	S	*	3/2010	Enriquez	.....	D28/4
D626,420	S	*	11/2010	Mondon	.....	D9/551
D677,168	S	*	3/2013	Bourguignon	.....	D9/645
D695,628	S	*	12/2013	Chen	.....	D9/688
D707,560	S	*	6/2014	Wallace et al.	.....	D9/500
D734,671	S	*	7/2015	Herbst	.....	D9/538
D736,093	S	*	8/2015	Clark	.....	D9/682
2008/0257855	A1	*	10/2008	Patel	.....	215/370

\* cited by examiner

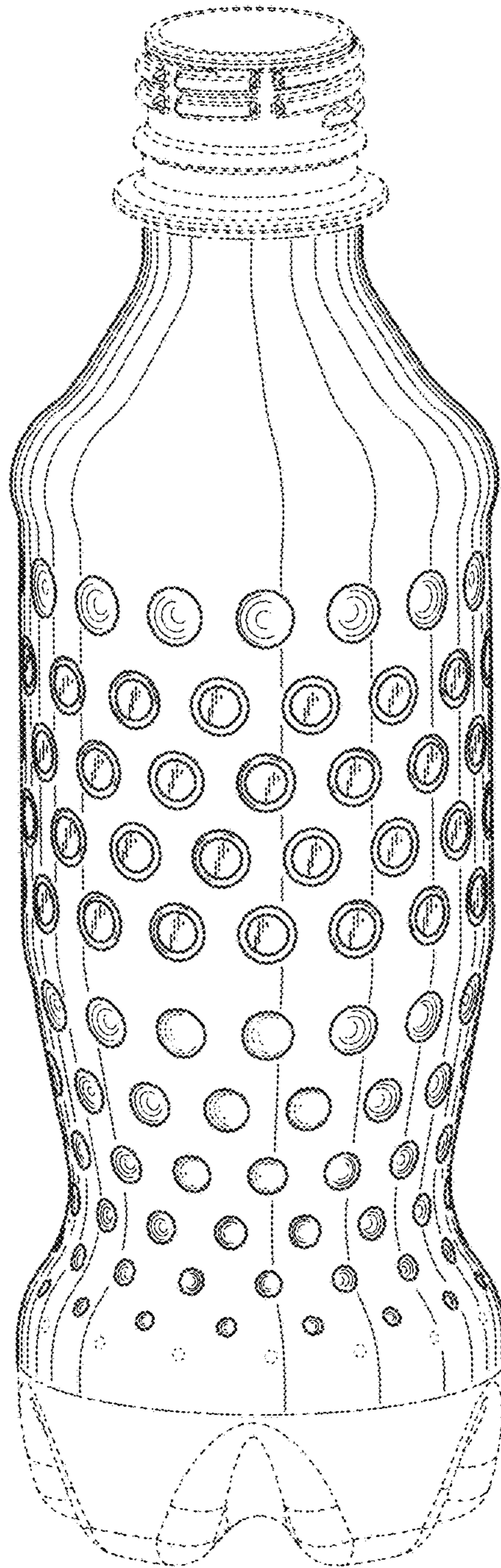

**FIG. 1**

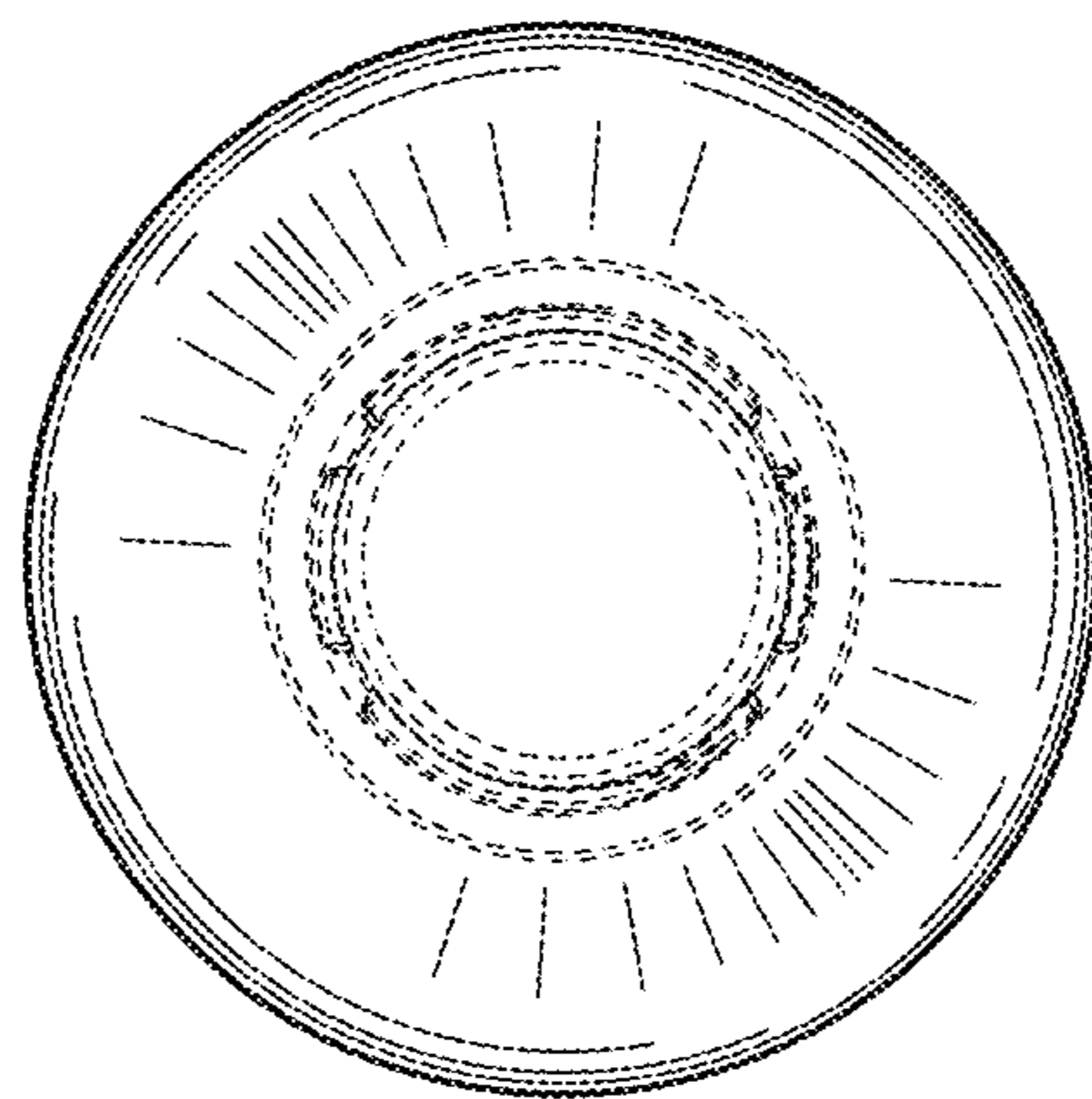

**FIG. 2**

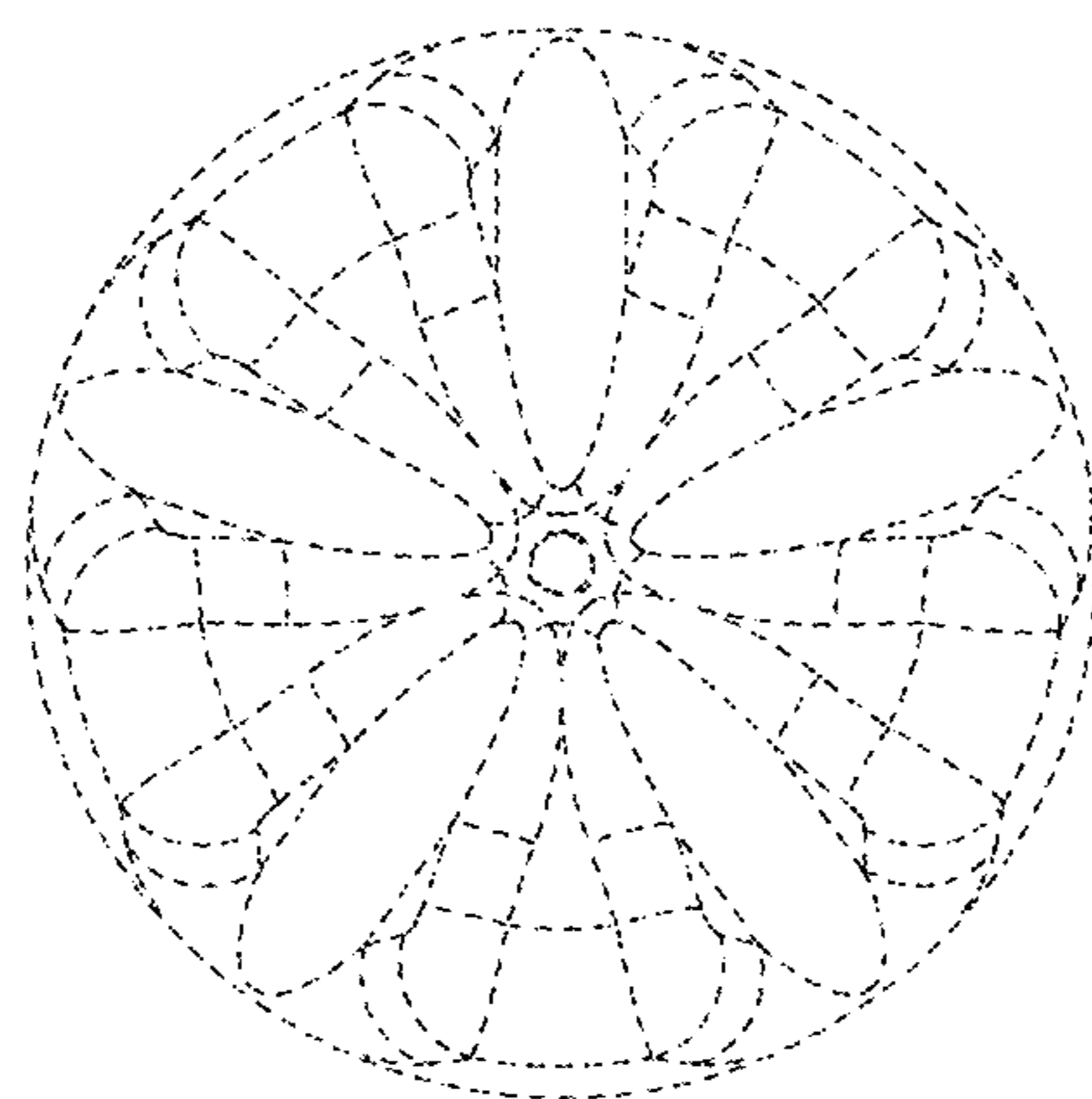

**FIG. 3**

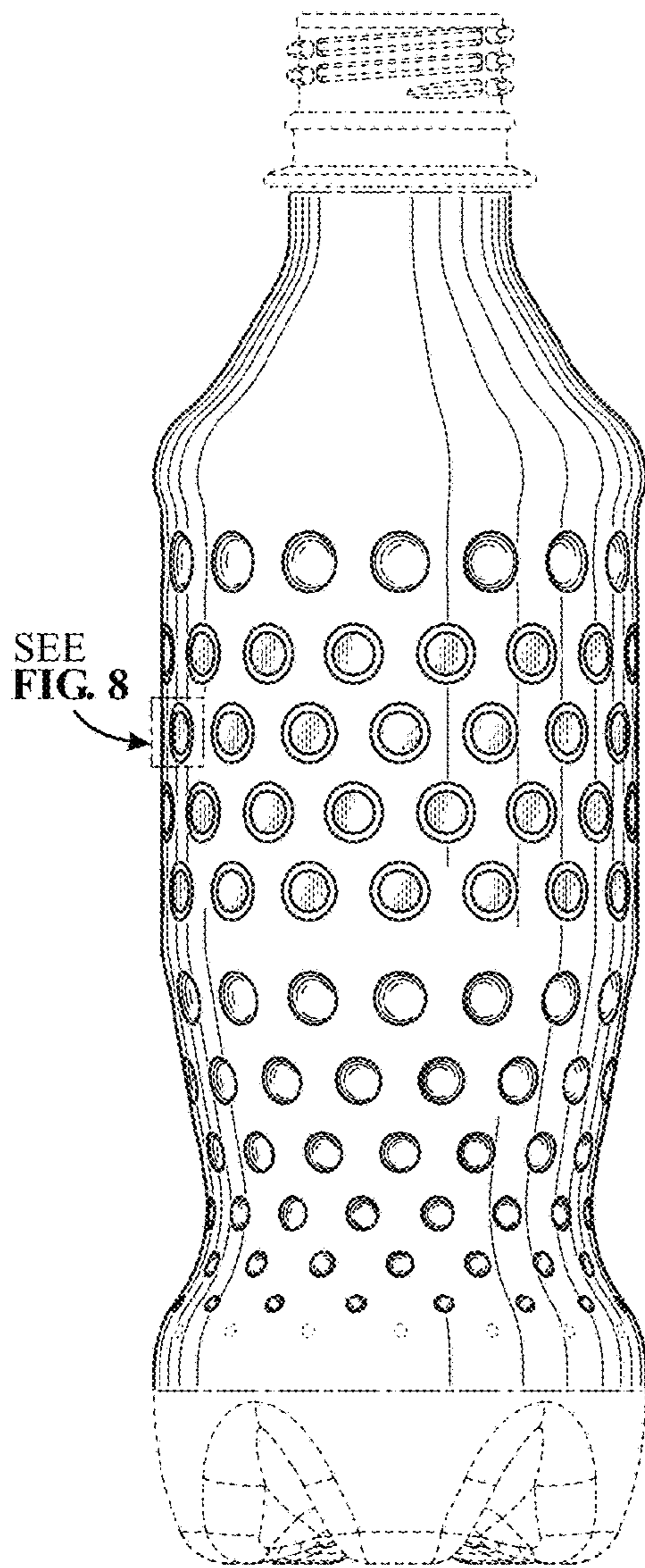

FIG. 4

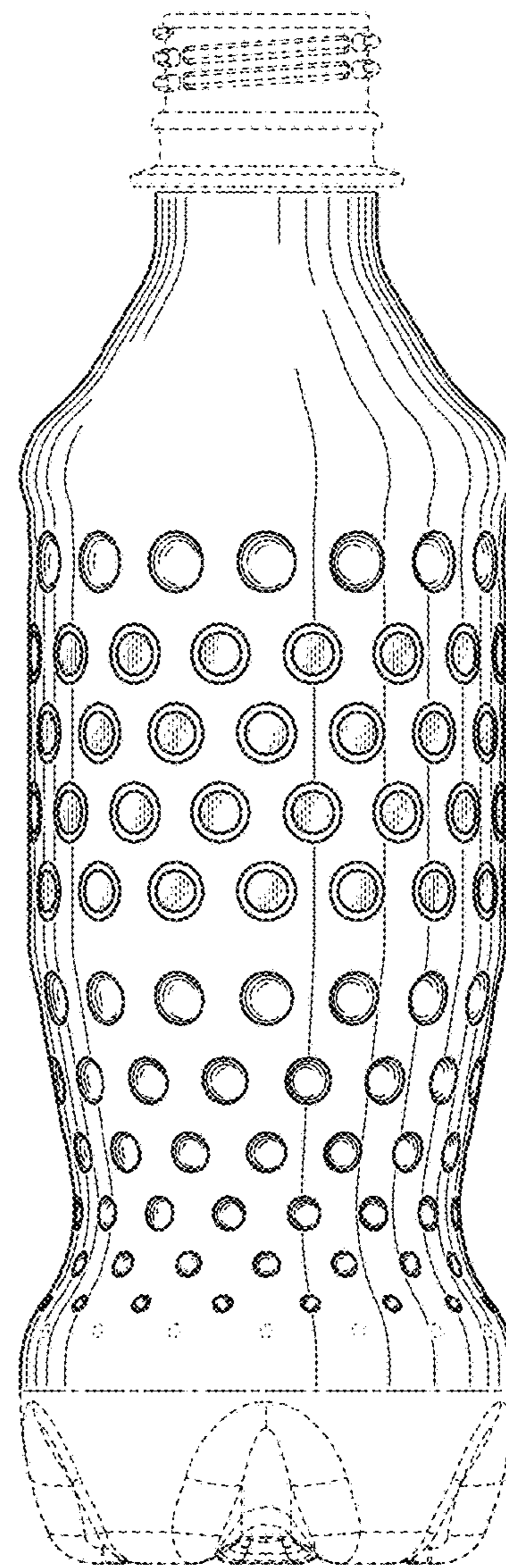
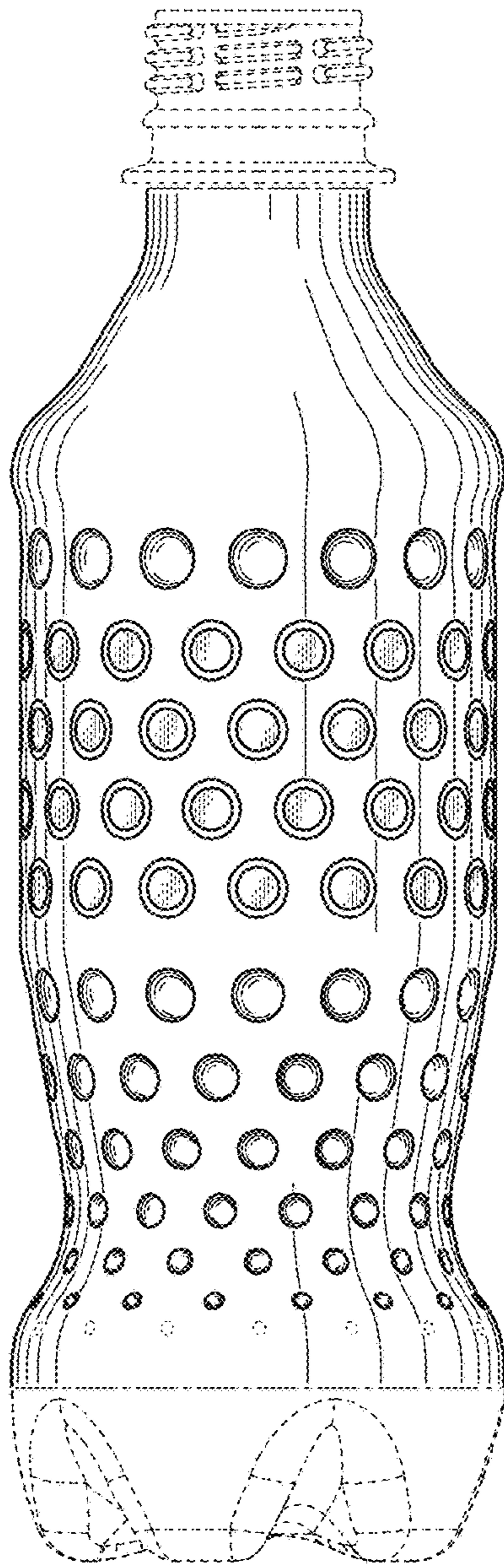
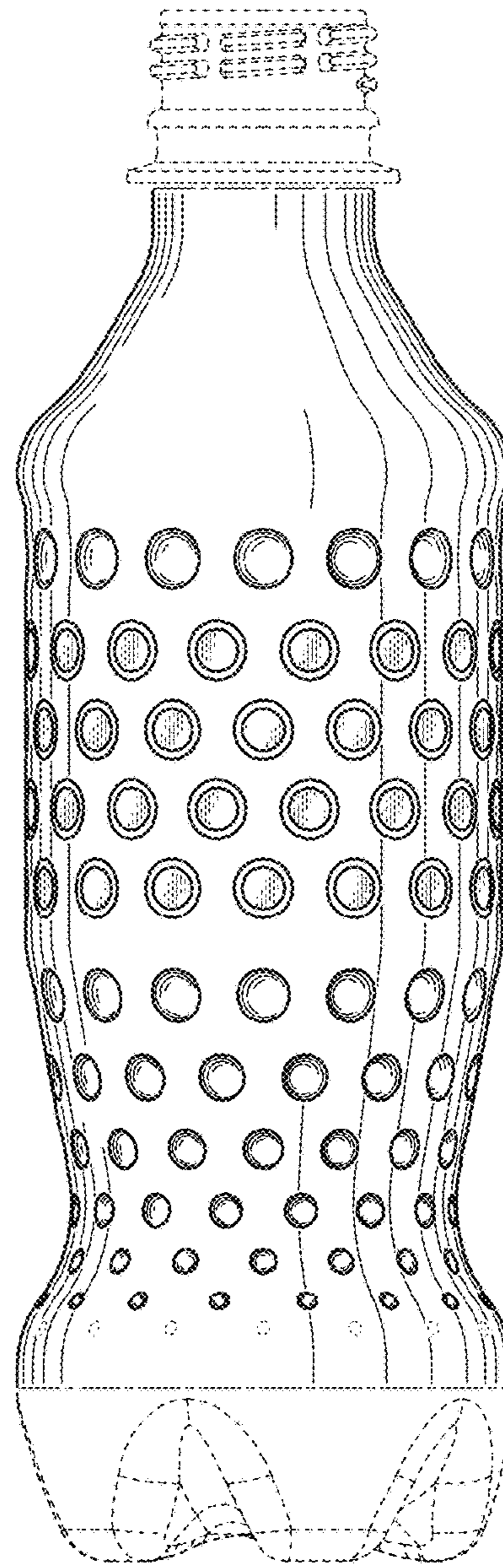

FIG. 5



**FIG. 6**



**FIG. 7**

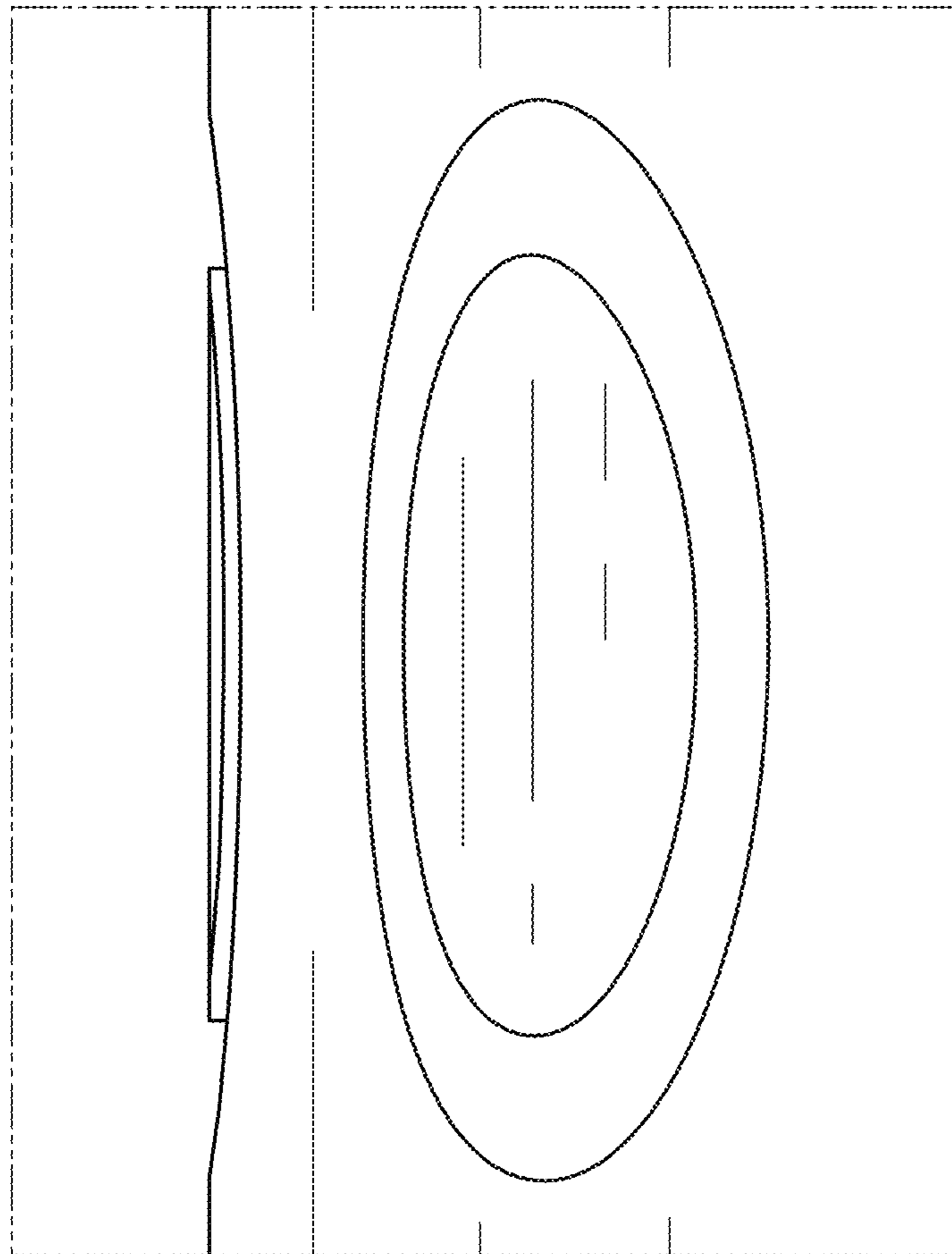

**FIG. 8**

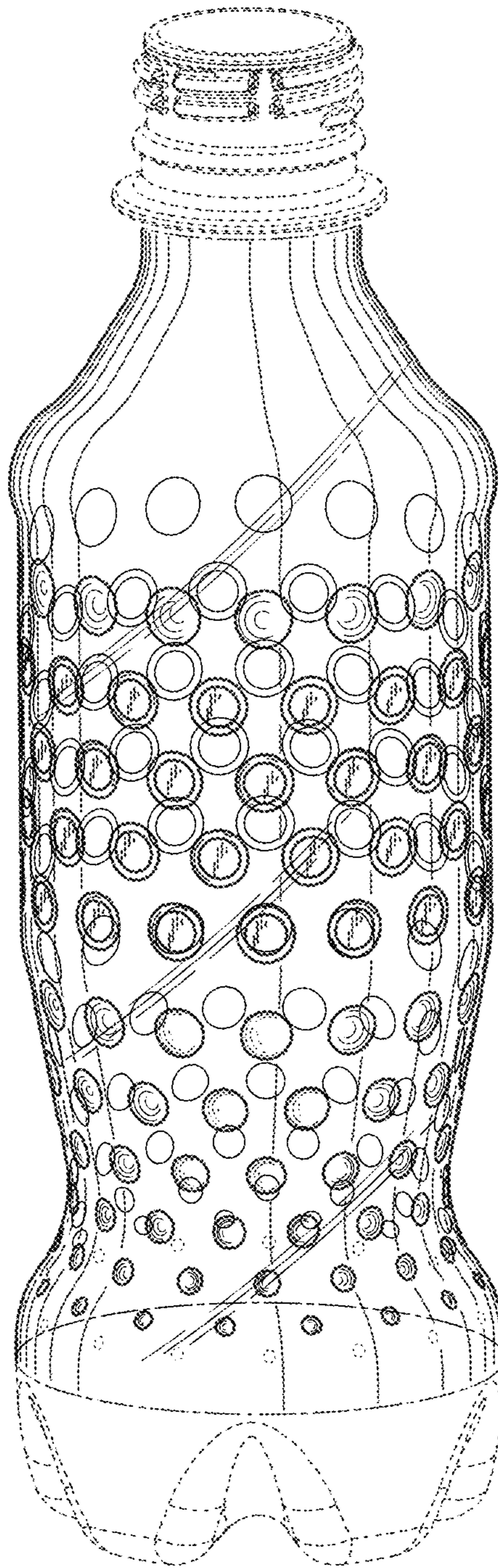
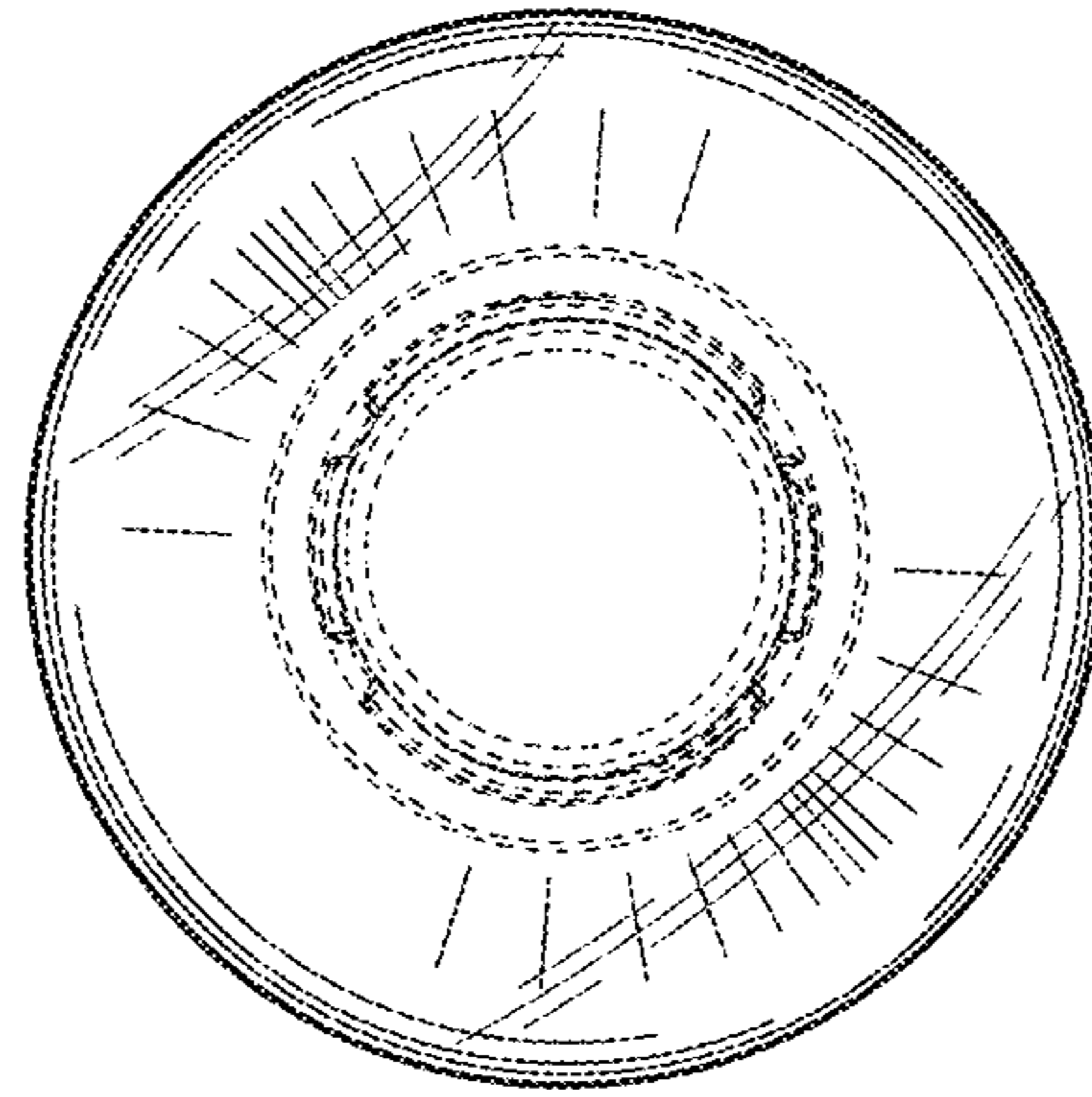
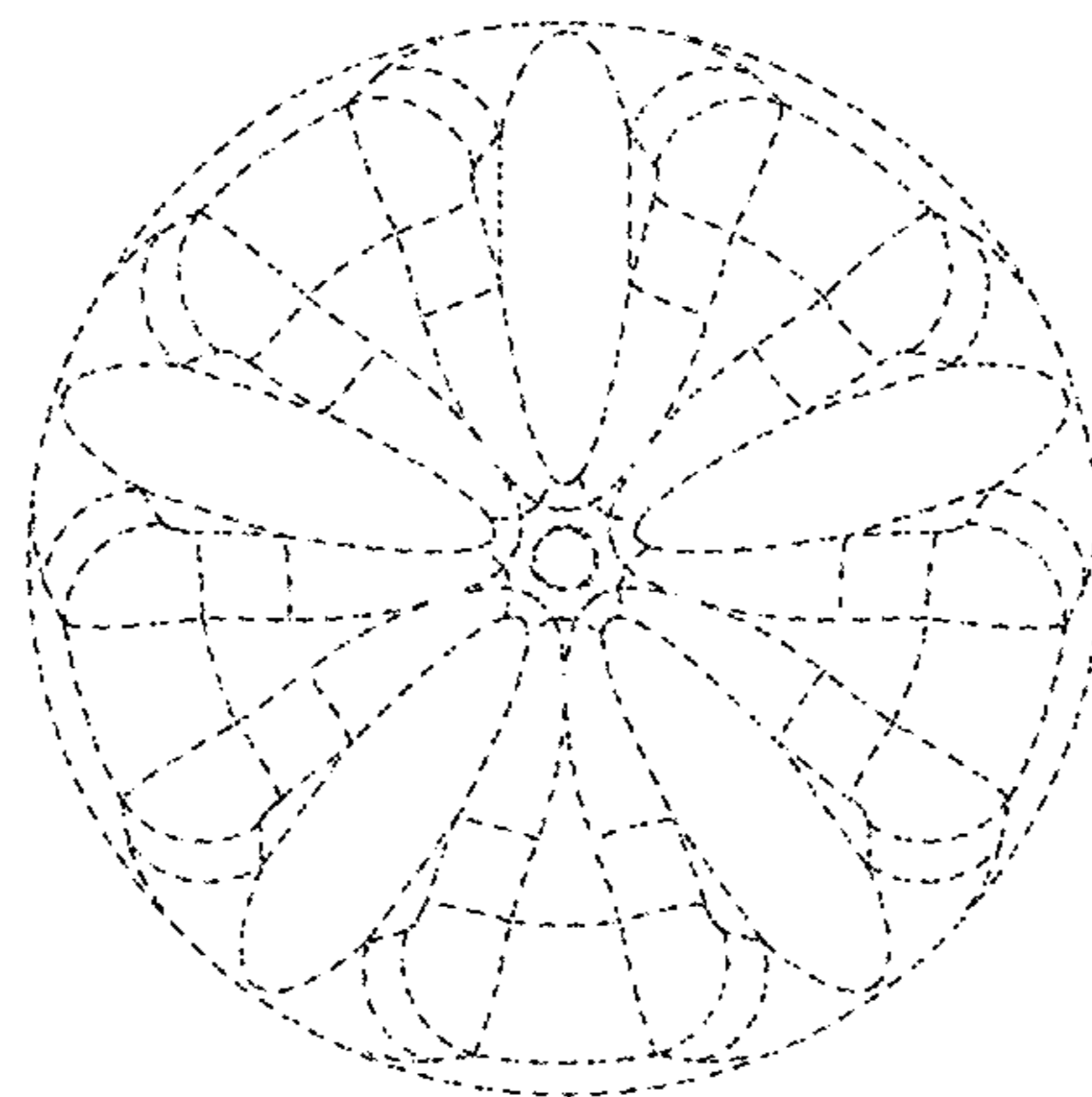

FIG. 9





**FIG. 10**



**FIG. 11**

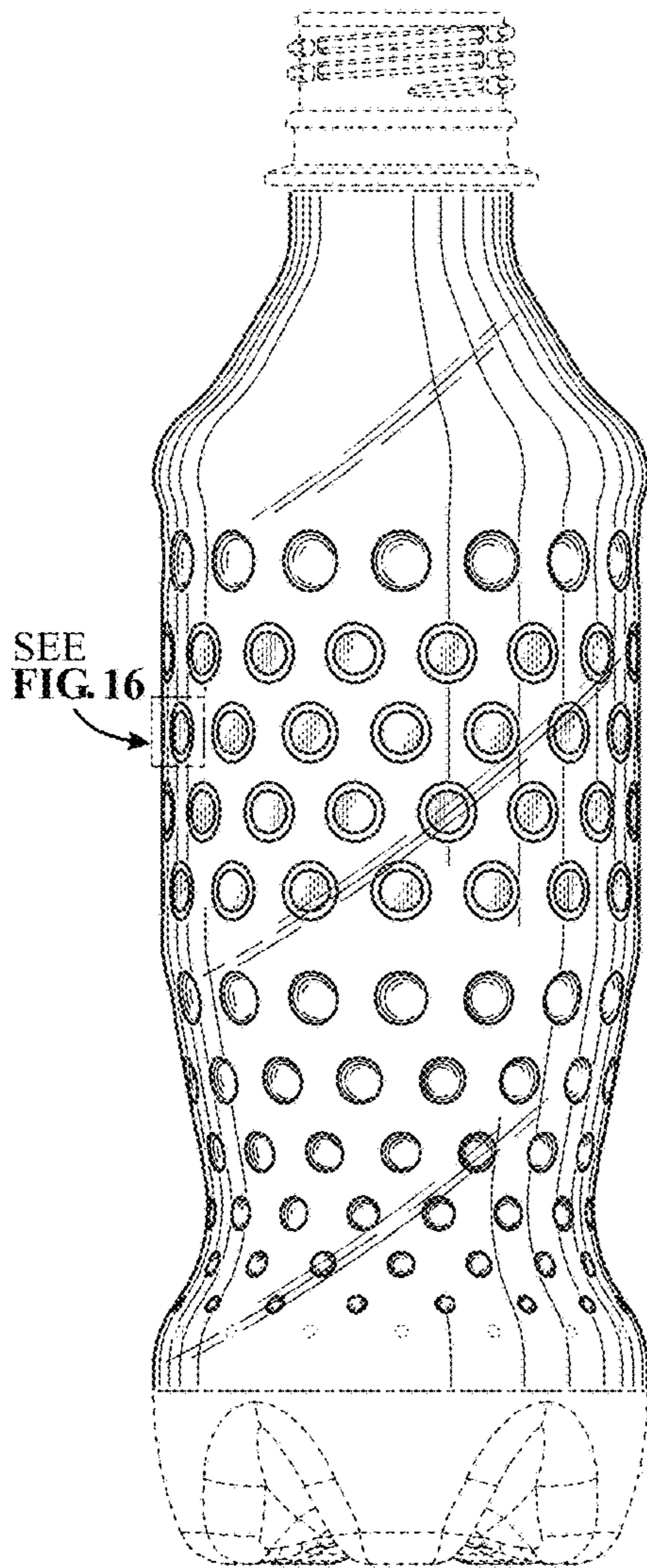

FIG. 12

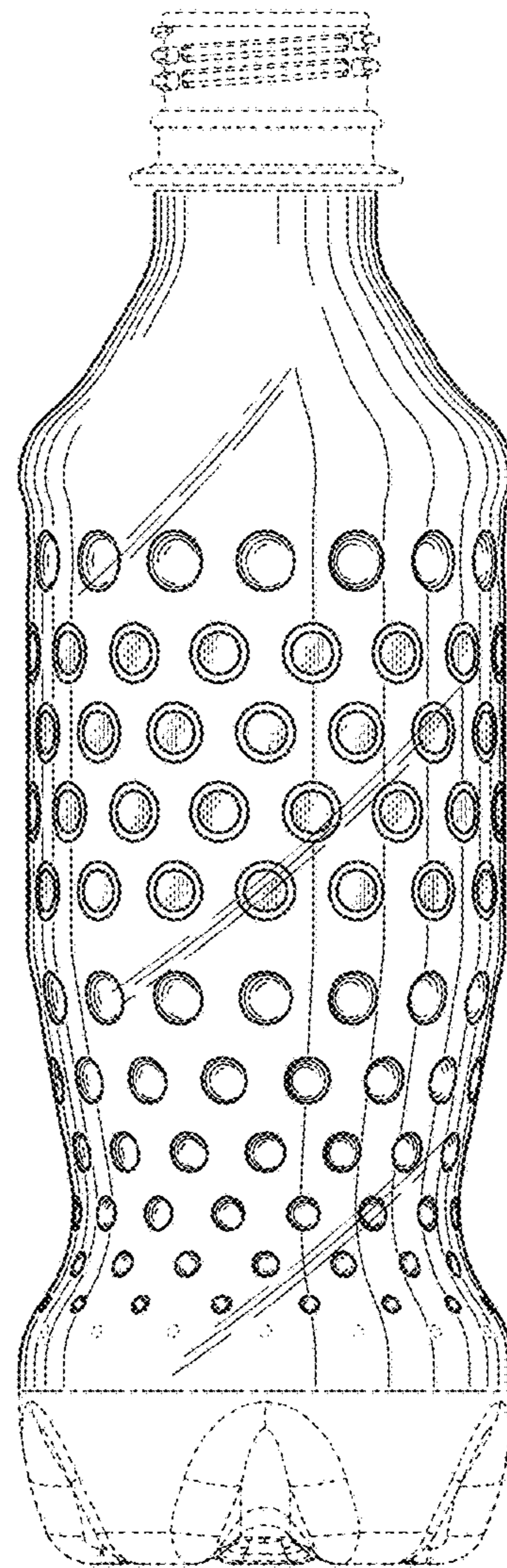
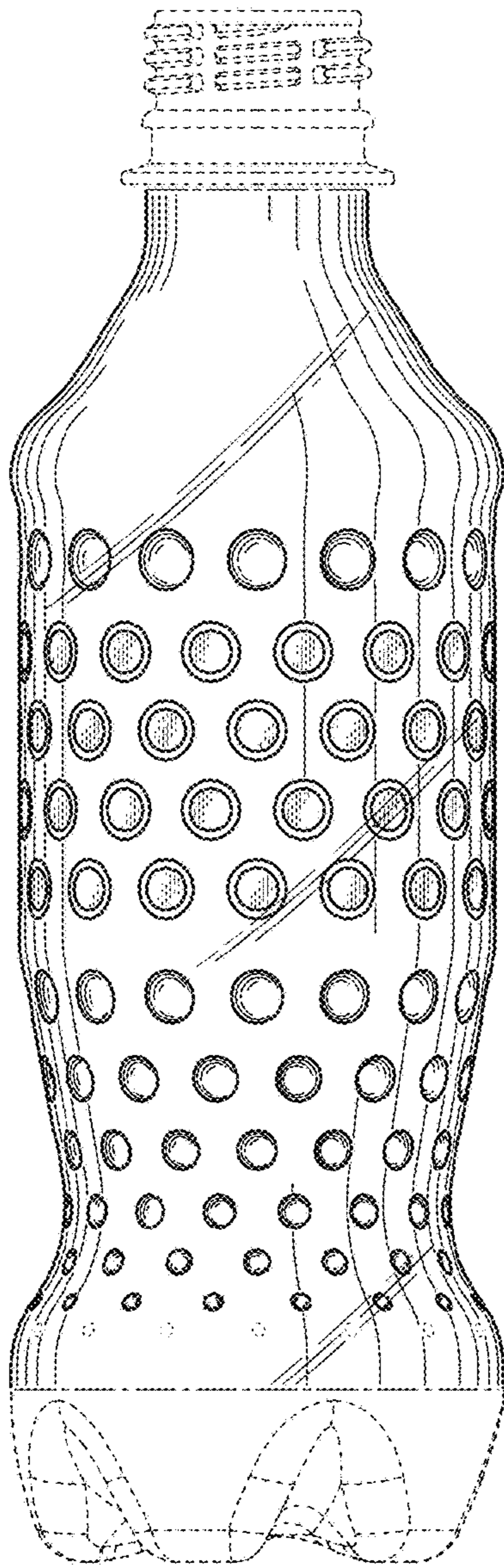
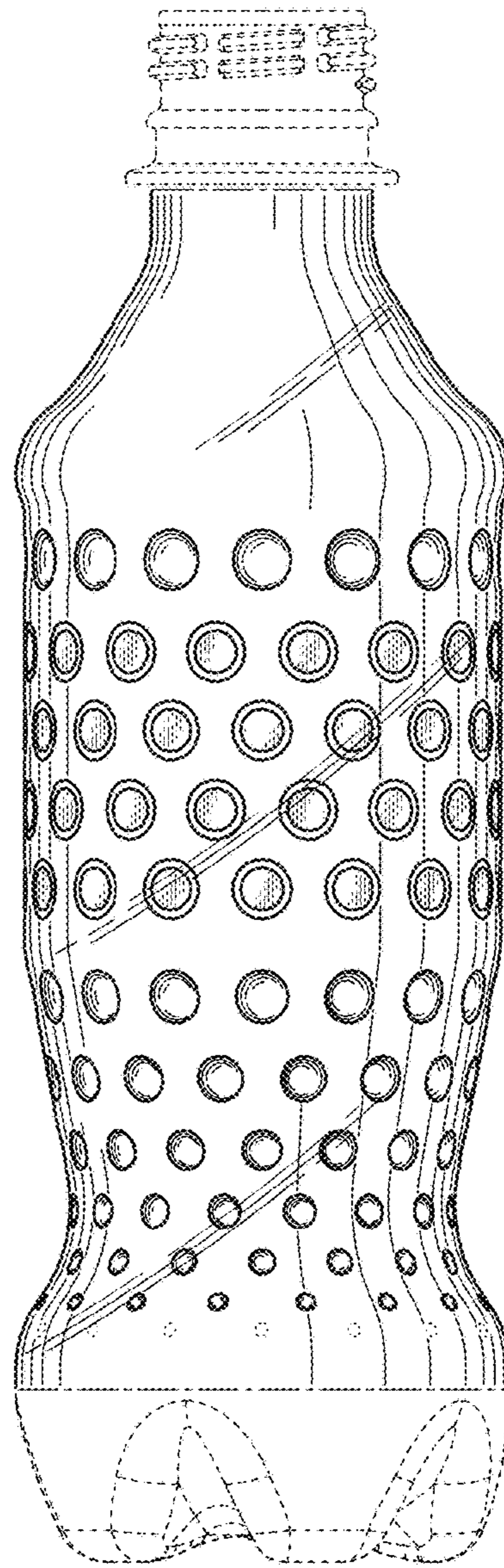

FIG. 13



**FIG. 14**



**FIG. 15**

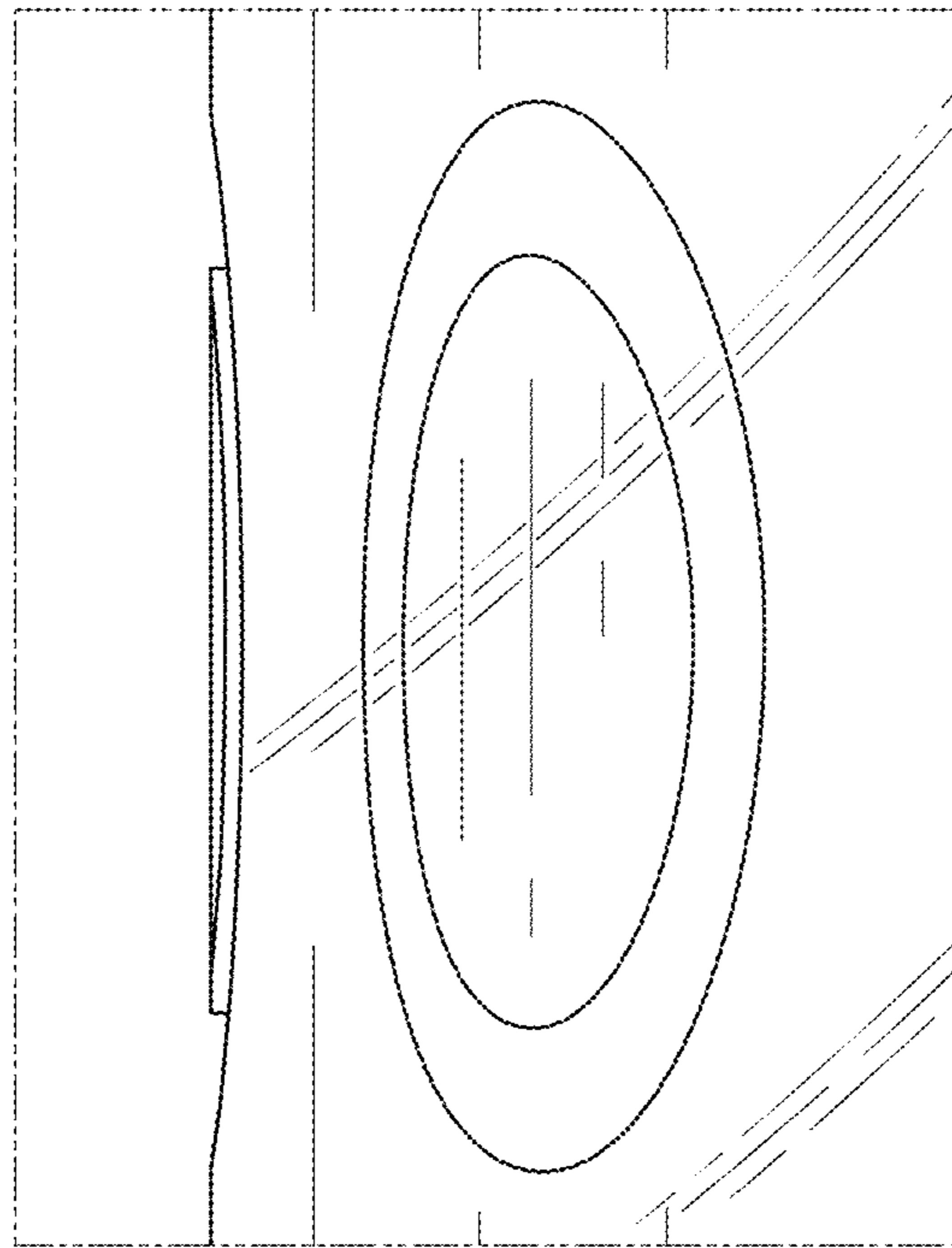

**FIG. 16**