



US00D796322S

(12) **United States Design Patent**
Hanson

(10) **Patent No.:** **US D796,322 S**

(45) **Date of Patent:** **** Sep. 5, 2017**

(54) **TRIGGER-ACTUATED DISPENSING NOZZLE**

(71) Applicant: **Homax Products, Inc.**, Bellingham, WA (US)

(72) Inventor: **Randal W. Hanson**, Bellingham, WA (US)

(73) Assignee: **PPG Architectural Finishes, Inc.**, Pittsburgh, PA (US)

(**) Term: **15 Years**

(21) Appl. No.: **29/571,153**

(22) Filed: **Jul. 14, 2016**

Related U.S. Application Data

(60) Continuation of application No. 29/510,730, filed on Dec. 2, 2014, now abandoned, which is a division of application No. 29/458,036, filed on Jun. 14, 2013, now Pat. No. Des. 718,624.

(51) **LOC (10) Cl.** **09-07**

(52) **U.S. Cl.**
USPC **D9/448**

(58) **Field of Classification Search**
USPC D9/434, 435, 448, 449; D23/213, 226; 222/323, 383.1, 383.3, 402.15; 239/120, 239/215, 333, 394, 526, 539; 417/178, 417/198, 411
CPC B65D 83/205; B65D 83/206
See application file for complete search history.

(56) **References Cited**

U.S. PATENT DOCUMENTS

5,775,432 A * 7/1998 Burns A62C 17/00
169/74
D438,786 S * 3/2001 Ghali D9/685
D464,395 S * 10/2002 Huang D23/226

D501,538 S * 2/2005 Zeng D23/226
D501,914 S * 2/2005 Chen D23/223
D502,533 S * 3/2005 Chen D23/223
D512,309 S * 12/2005 Geier D9/448
D600,119 S * 9/2009 Sweeton D9/448
D661,580 S * 6/2012 Takizawa D9/448
8,444,026 B2 * 5/2013 Adams B65D 83/205
222/153.11
D718,624 S * 12/2014 Hanson D9/448
2012/0097713 A1 * 4/2012 MacKinnon B65D 83/206
222/402.13
2013/0112766 A1 * 5/2013 Maas B65D 83/62
239/1

* cited by examiner

Primary Examiner — Robert M Spear

(74) *Attorney, Agent, or Firm* — Michael A. Schacht

(57) **CLAIM**

The ornamental design for a trigger-actuated dispensing nozzle, as shown and described.

DESCRIPTION

FIG. 1 is a front elevation view of a trigger-actuated dispensing nozzle of the present invention;
FIG. 2 is a first side elevation view of the trigger-actuated dispensing nozzle;
FIG. 3 is a rear end elevation view of the trigger-actuated dispensing nozzle;
FIG. 4 is a second side elevation view of the trigger-actuated dispensing nozzle;
FIG. 5 is a top plan view of the trigger-actuated dispensing nozzle; and,
FIG. 6 is a bottom plan view of the trigger-actuated dispensing nozzle.

The evenly broken lines are shown for the purpose of illustrations of parts of the article that form no part of the claim. The dot-dash broken lines are shown for the purpose of illustrating environmental structure and form no part of the claim.

1 Claim, 3 Drawing Sheets

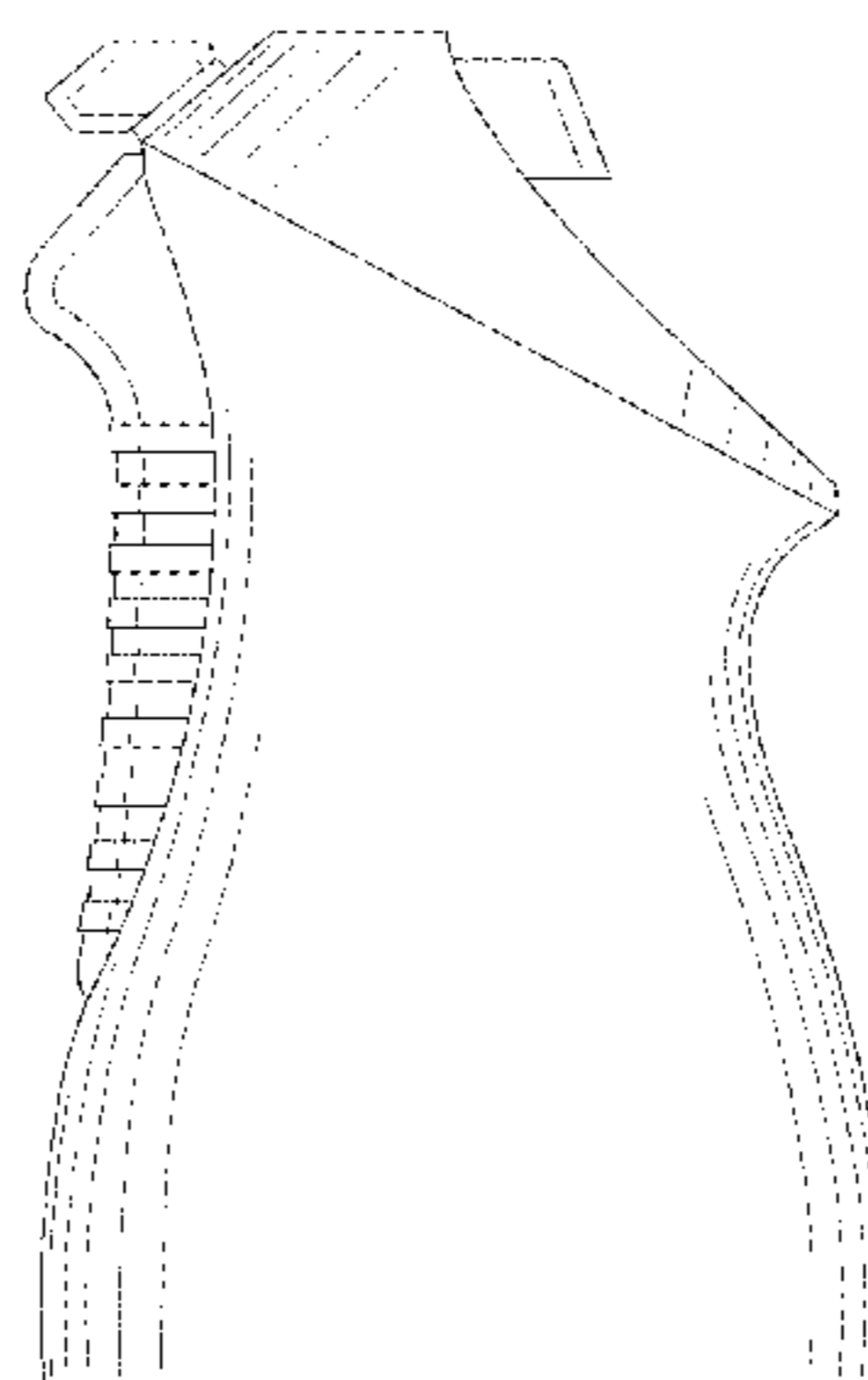
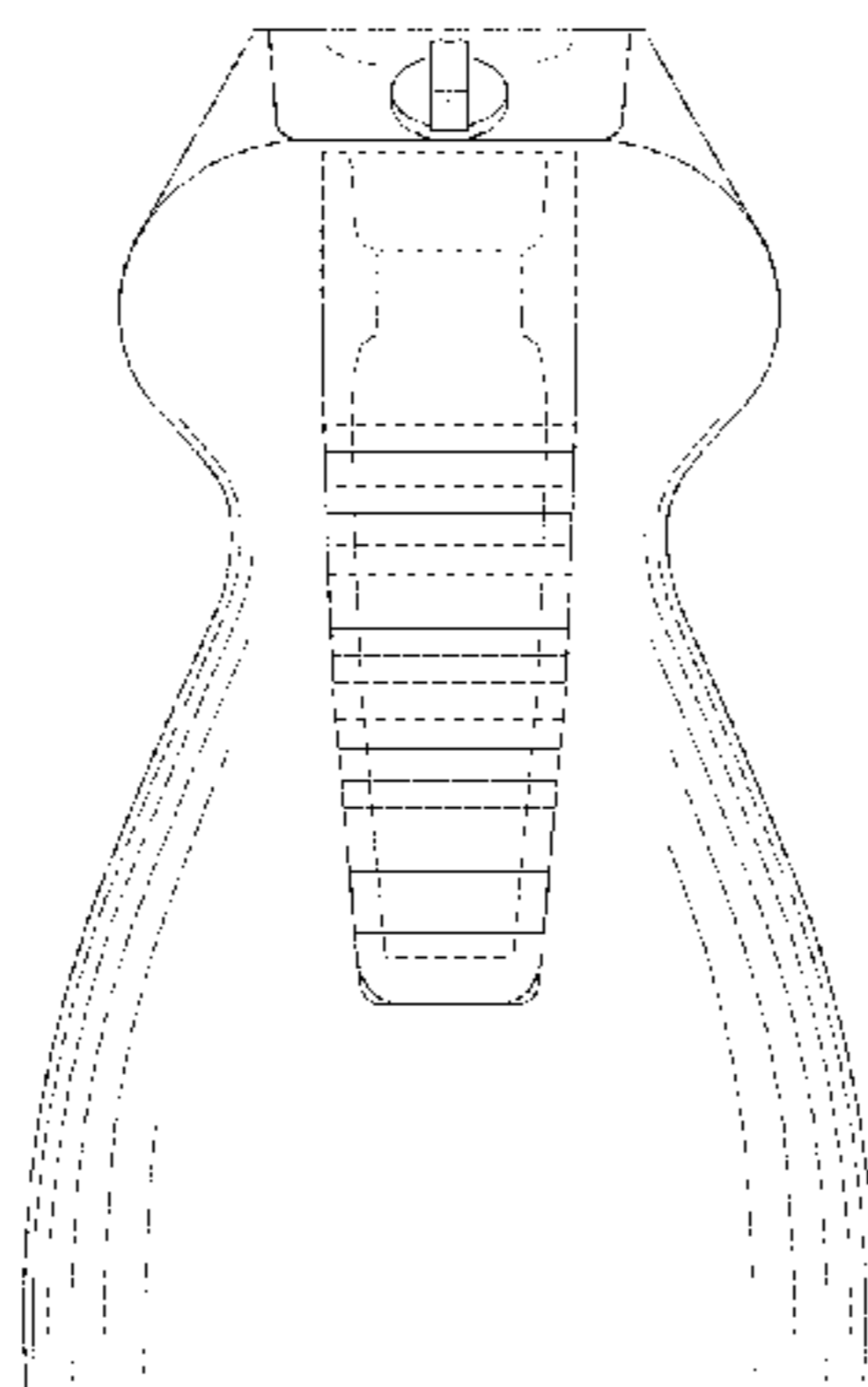

FIG. 1

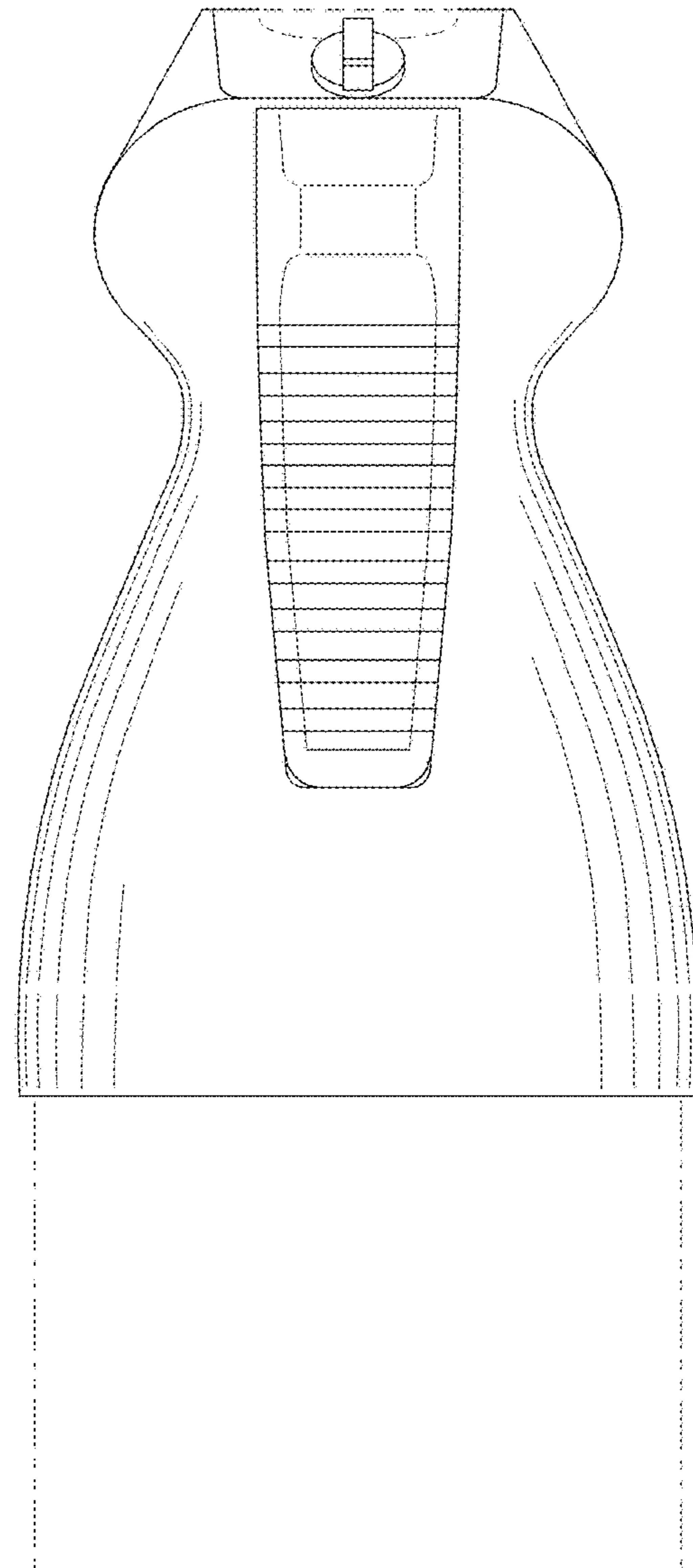

FIG. 2

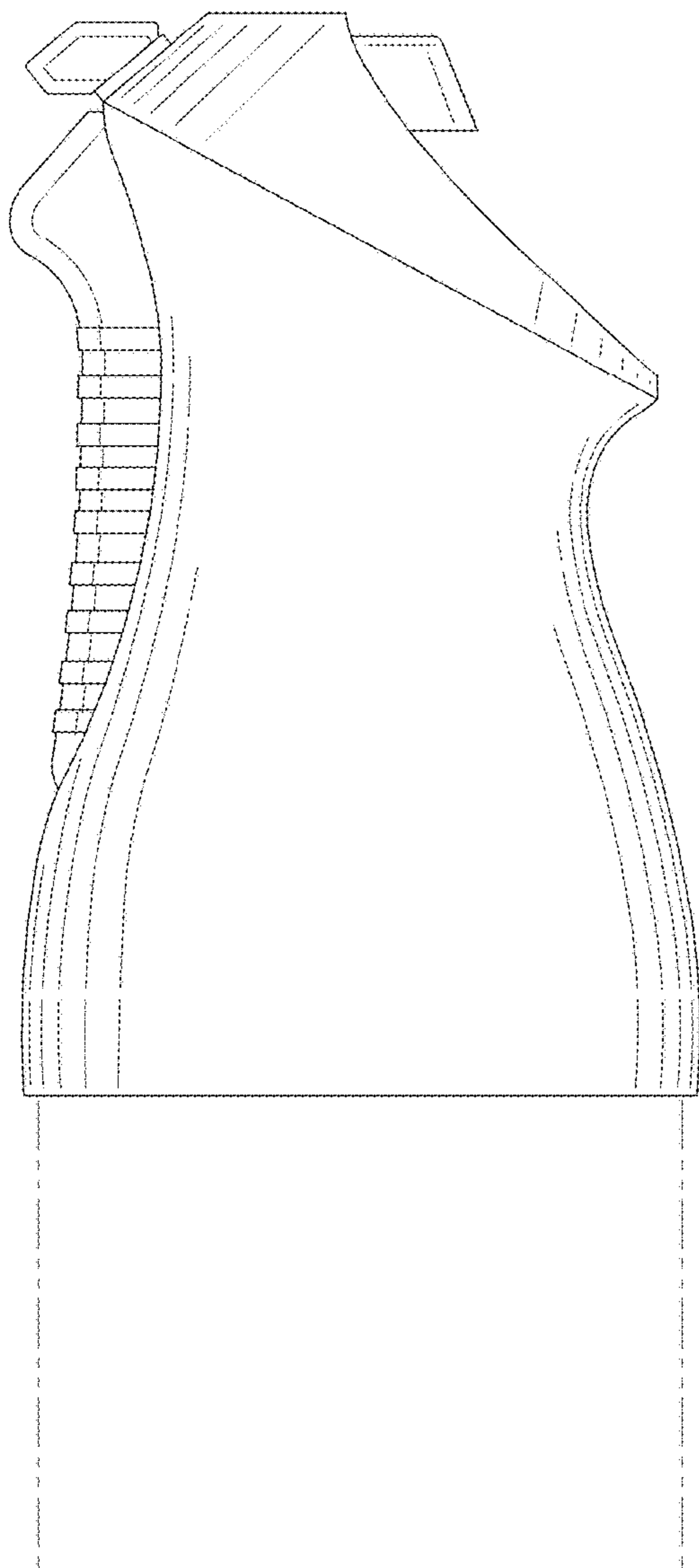

FIG. 3

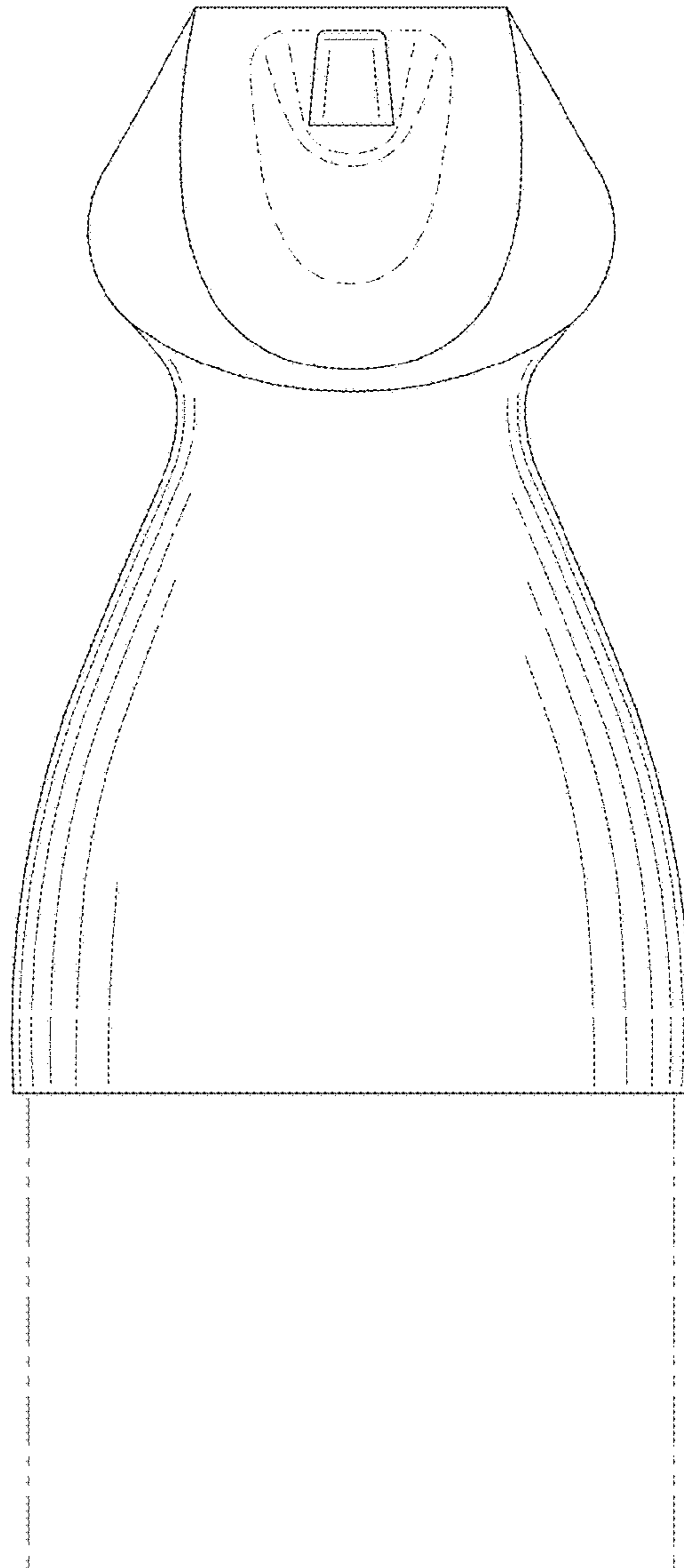

FIG. 4

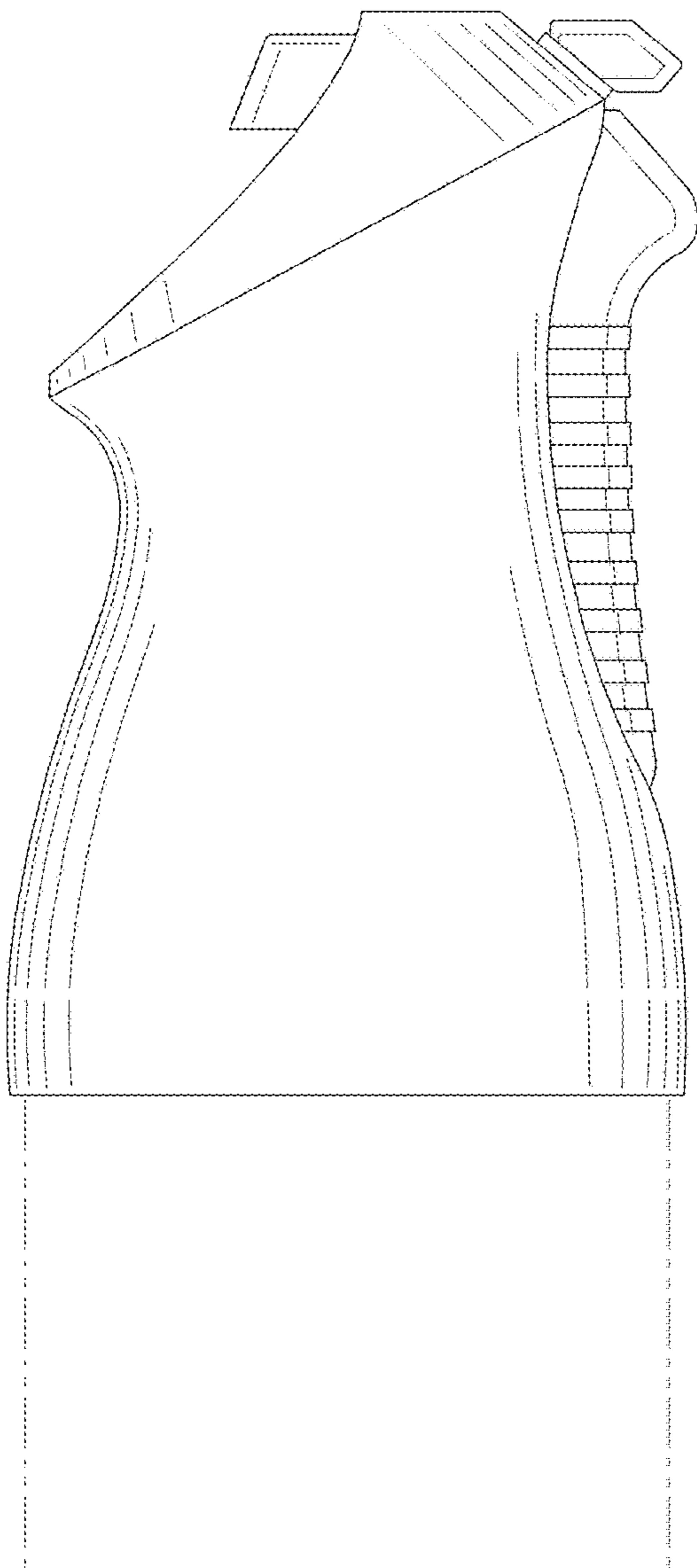

FIG. 5

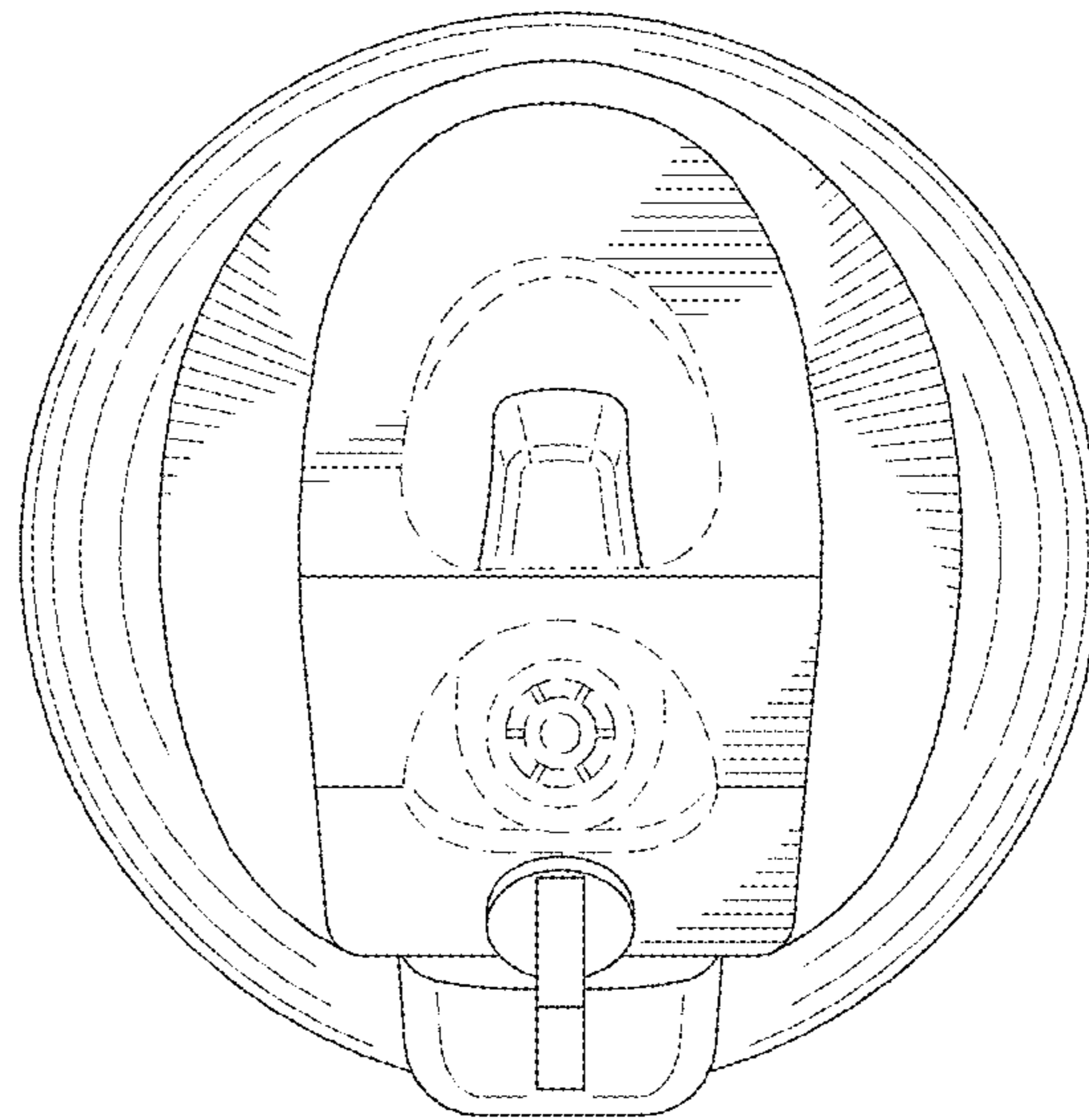

FIG. 6

