



US00D796265S

(12) **United States Design Patent**
Lapsker

(10) **Patent No.:** **US D796,265 S**

(45) **Date of Patent:** **** Sep. 5, 2017**

(54) **BEVERAGEWARE**

(71) Applicant: **Starline Global Inc.**, Bridgetown (BB)

(72) Inventor: **Ron Lapsker**, Concord (CA)

(73) Assignee: **STARLINE GLOBAL INC.**,
Bridgetown (BB)

(**) Term: **15 Years**

(21) Appl. No.: **29/535,244**

(22) Filed: **Aug. 5, 2015**

(51) **LOC (10) Cl.** **07-01**

(52) **U.S. Cl.**

USPC **D7/532; D7/523; D7/510; D7/533**

(58) **Field of Classification Search**

USPC D7/507, 509, 510, 511, 523, 529, 531,
D7/532, 533, 535, 536, 508, 392.1, 396.2,
D7/387, 543, 608; D8/33, 34;
220/592.16, 592.17, 295.03, 718, 719,
220/495.03, 62.12, 710.5; D9/517, 567,
D9/554, 555, 558, 503, 504, 552, 540
CPC .. B25B 13/52; B67B 7/00; B67B 7/14; B67B
7/16; A47G 19/22; A47G 19/2227; A45F
3/20

See application file for complete search history.

(56) **References Cited**

U.S. PATENT DOCUMENTS

1,969,386 A * 8/1934 Reichenbach A47J 43/27

220/200

D265,973 S * 8/1982 Gombert D9/449

(Continued)

OTHER PUBLICATIONS

Sovrano Gifts, "16 Oz. Acrylic/Stainless Steel Tumbler w/ Silicone Color Bands", <https://sovrano gifts.com/product/16-oz-acrylicstainless-steel-tumbler-w-silicone-color-band/>, last accessed Jun. 13, 2017.

(Continued)

Primary Examiner — Marianne Pandozzi

Assistant Examiner — Jae Liang

(74) *Attorney, Agent, or Firm* — Hodgson Russ LLP

(57) **CLAIM**

The ornamental design for beverageware, as shown and described.

DESCRIPTION

FIG. 1 is a perspective view of a first embodiment of a beverageware showing my new design;

FIG. 2 is a left side view thereof;

FIG. 3 is a right side view thereof;

FIG. 4 is a front view thereof;

FIG. 5 is a rear view thereof;

FIG. 6 is a top view thereof;

FIG. 7 is a bottom view thereof;

FIG. 8 is a perspective view of a second embodiment of a beverageware;

FIG. 9 is a left side view thereof;

FIG. 10 is a right side view thereof;

FIG. 11 is a front view thereof;

FIG. 12 is a rear view thereof;

FIG. 13 is a top view thereof;

FIG. 14 is a bottom view thereof; and,

FIG. 15 is a left side view of a third embodiment of a beverage with upper and lower bands having contrasting appearances, the perspective, right side, front, rear, top and bottom views correspond to FIGS. 8-14, except for the upper and lower bands of the third embodiment have contrasting appearances.

The broken lines in the drawing depict portions of the beverageware that form no part of the claimed design. The dash-dot lines in the drawing depict bounds of the claimed design that form no part of the claimed design. The difference in cross-hatching patterns on the upper and lower bands of FIG. 15 is used to indicate a contrast in appearance.

1 Claim, 13 Drawing Sheets

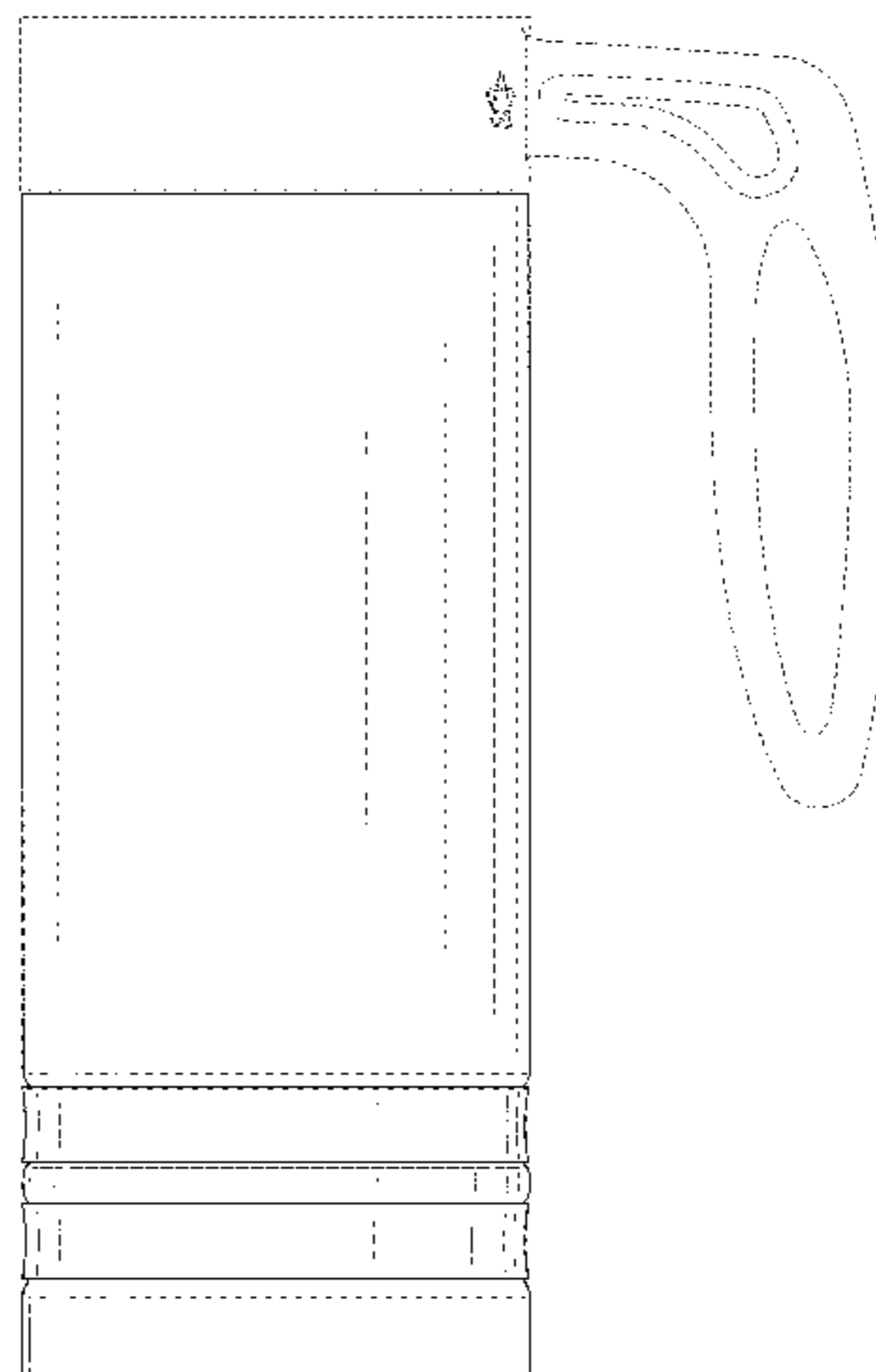
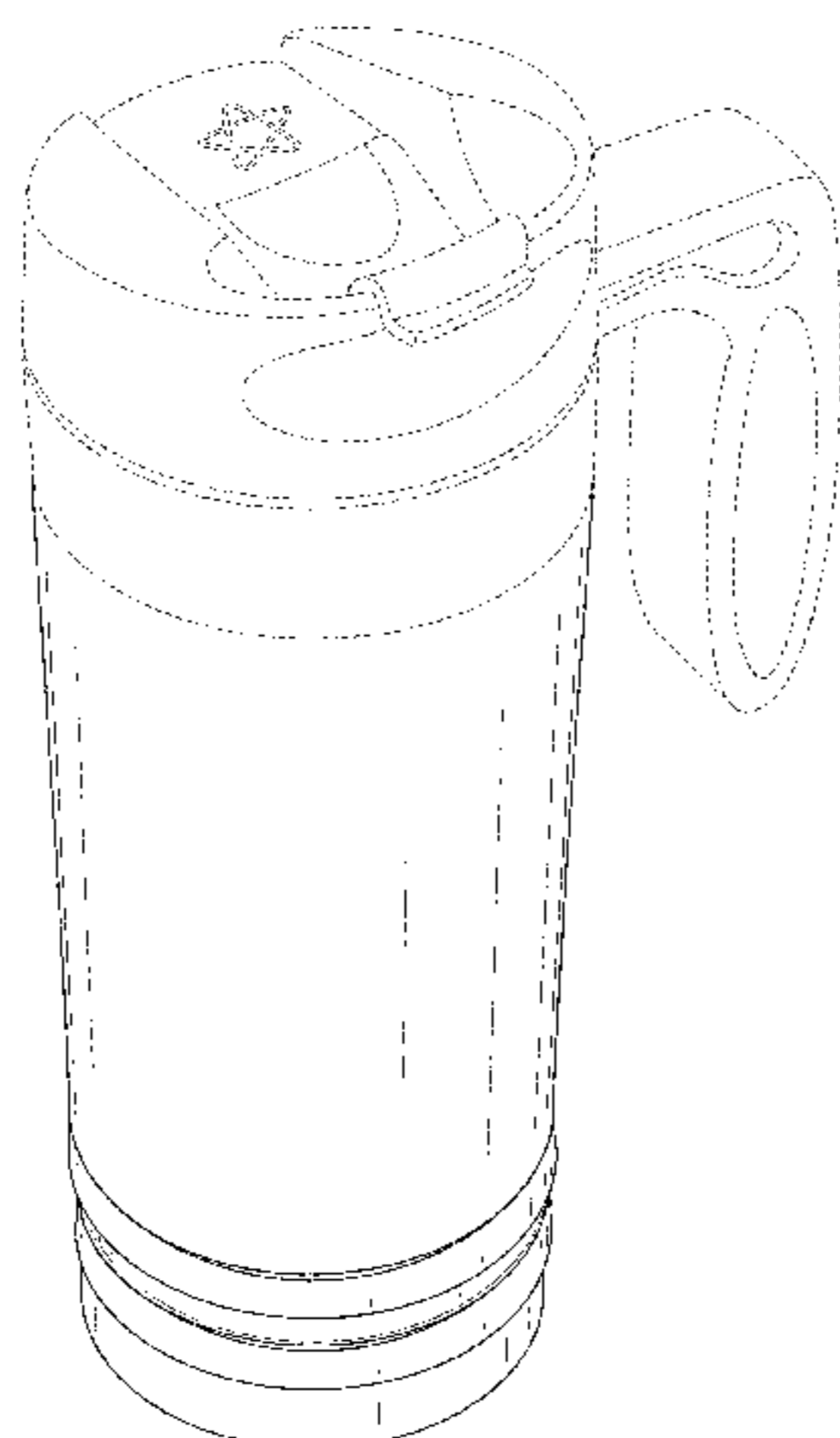

(56)

References Cited

U.S. PATENT DOCUMENTS

D279,355 S * 6/1985 Ujiie D9/414
 D368,655 S * 4/1996 Chahed D9/429
 D460,324 S 7/2002 Norris et al.
 D460,661 S 7/2002 Norris et al.
 D464,849 S 10/2002 Norris et al.
 D468,588 S 1/2003 Norris et al.
 D469,658 S 2/2003 Norris et al.
 D479,669 S 9/2003 Norris et al.
 D482,933 S 12/2003 Norris et al.
 D483,615 S 12/2003 Norris et al.
 D503,074 S 3/2005 Norris et al.
 D506,643 S * 6/2005 Norris D7/532
 D539,607 S 4/2007 Lapsker
 D539,608 S 4/2007 Lapsker
 D539,610 S 4/2007 Lapsker
 D540,119 S 4/2007 Lapsker
 D548,522 S * 8/2007 Greenspon D7/507
 D558,524 S * 1/2008 Schreitmueller D7/500
 D568,107 S * 5/2008 Bhavnani D7/509
 D571,152 S * 6/2008 Tien D7/509
 D572,083 S * 7/2008 Tien D7/509
 7,506,611 B1 * 3/2009 Lush A01K 5/0225
 119/52.1
 D593,802 S * 6/2009 Baek D7/509
 D611,815 S * 3/2010 Pearson D7/523
 8,181,816 B2 * 5/2012 Allen A47G 19/2266
 206/218

8,210,391 B2 * 7/2012 Luburic B65D 1/16
 206/508
 8,365,945 B2 * 2/2013 Yourist B65D 1/165
 220/669
 8,474,648 B1 * 7/2013 Ritzen A47J 41/02
 220/212
 D692,270 S 10/2013 Lapsker
 D698,428 S * 1/2014 Sands D23/314
 8,646,646 B2 * 2/2014 Yourist B65D 1/165
 220/669
 D701,428 S 3/2014 Lapsker
 D705,012 S 5/2014 Lapsker
 D712,739 S 9/2014 Lapsker
 D727,099 S * 4/2015 Eyal D7/509
 D746,634 S * 1/2016 Lapsker D7/510
 D746,635 S * 1/2016 Lapsker D7/510
 D754,484 S * 4/2016 Lapsker D7/523
 D761,621 S * 7/2016 Hsu D7/501
 9,516,961 B1 * 12/2016 Yambao A47G 19/2227

OTHER PUBLICATIONS

Zak Designs, "Zak! Designs HydraTrak Insulated Tumbler with Straw, BPA-free, 20 oz., Clear", https://www.amazon.com/Zak-Designs-HydraTrak-Insulated-BPA-free/dp/B01C3J0XH0/ref=pd_lpo_vtph_79_tr_t_3?_encoding=UTF8&psc=1&refRID=PCG45559V75EQ026Y5E8, last accessed Jun. 13, 2017.

* cited by examiner

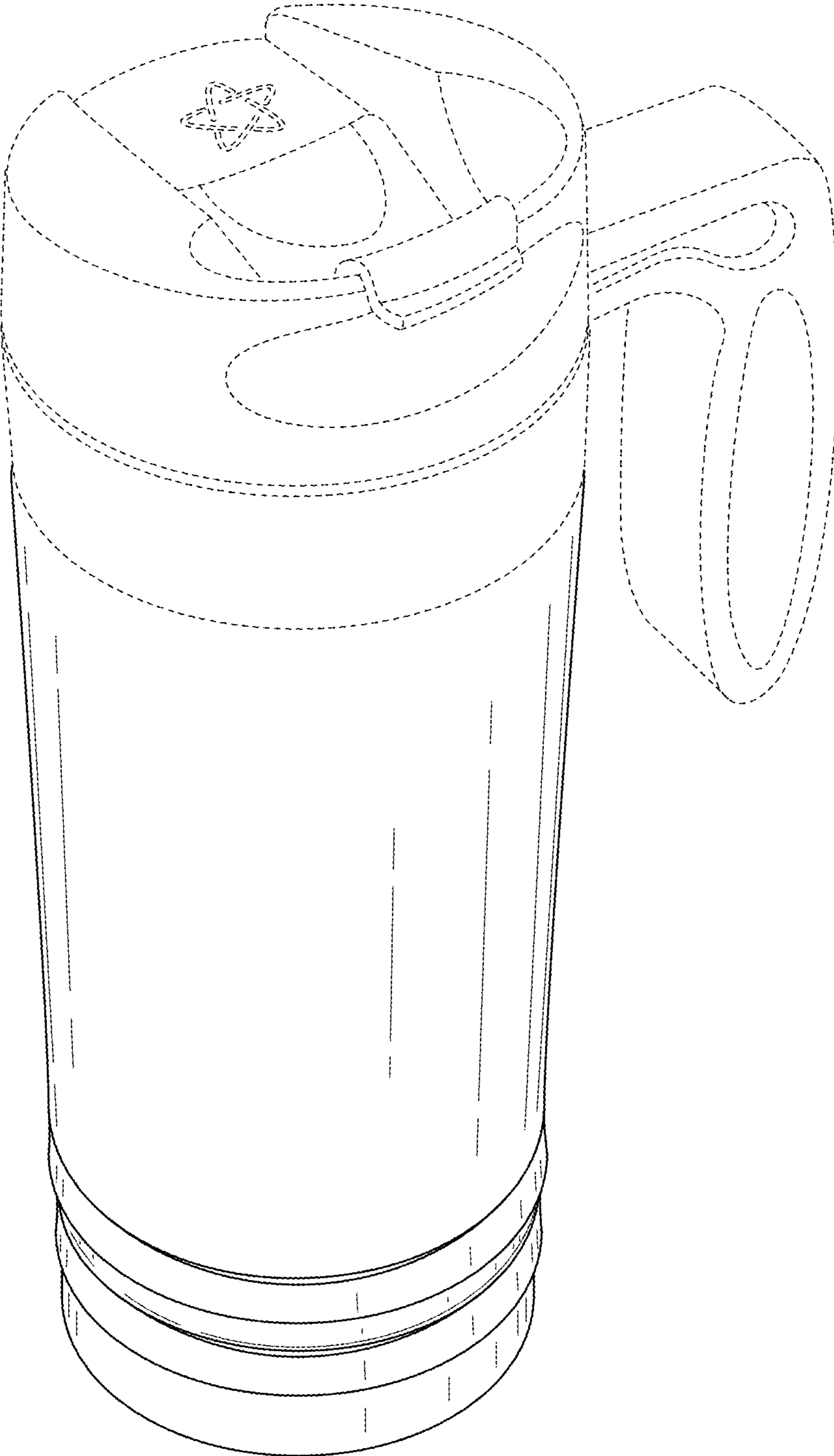

FIG. 1

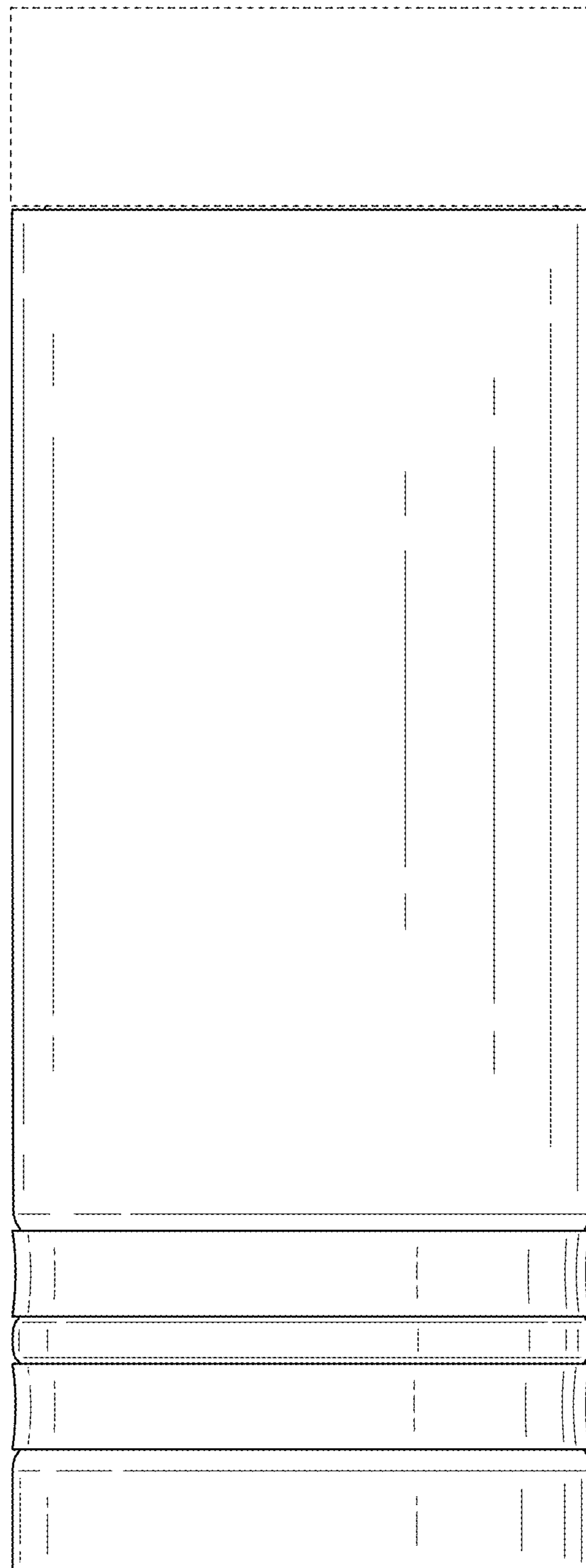

FIG. 2

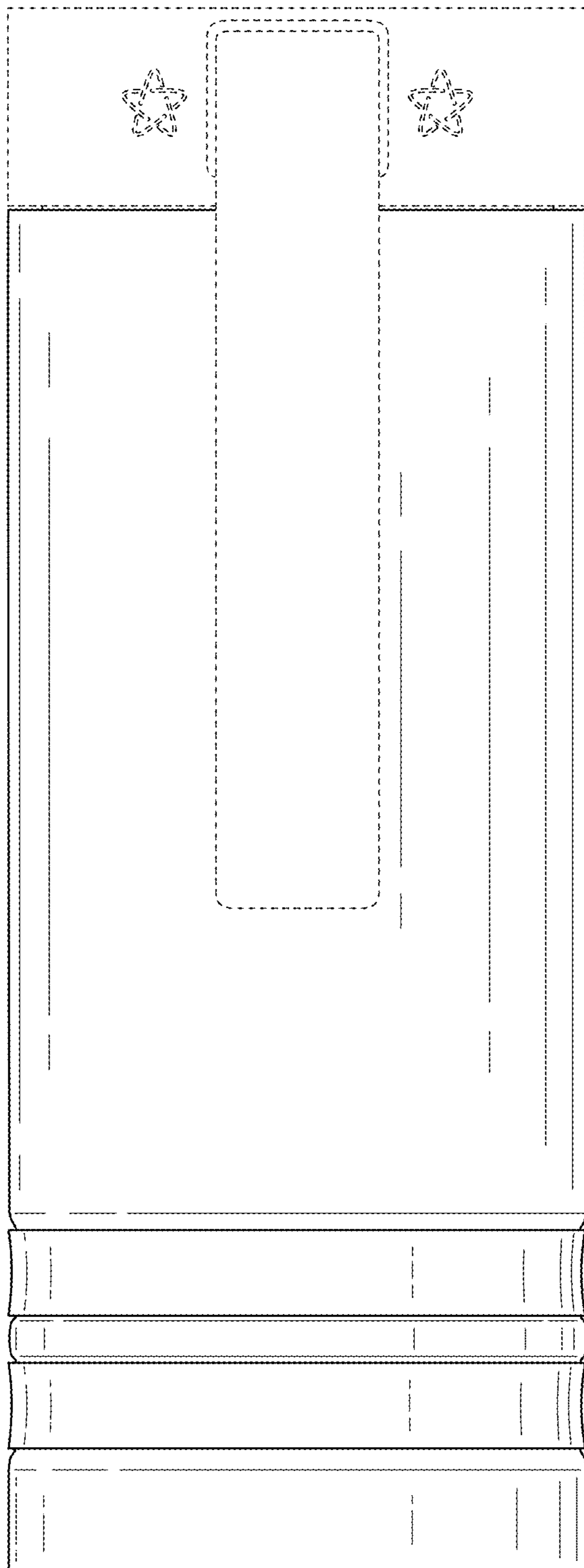

FIG. 3

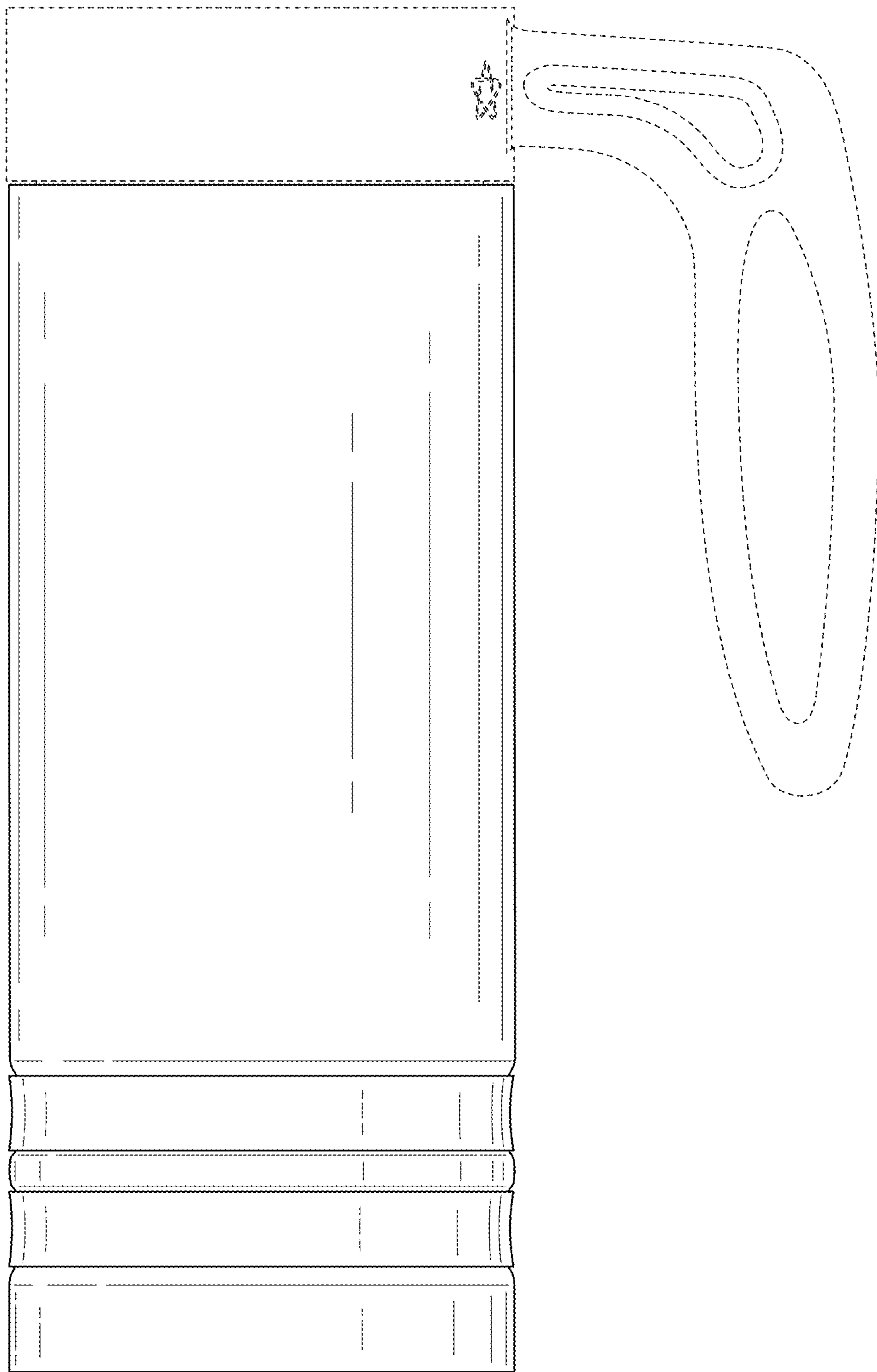

FIG. 4

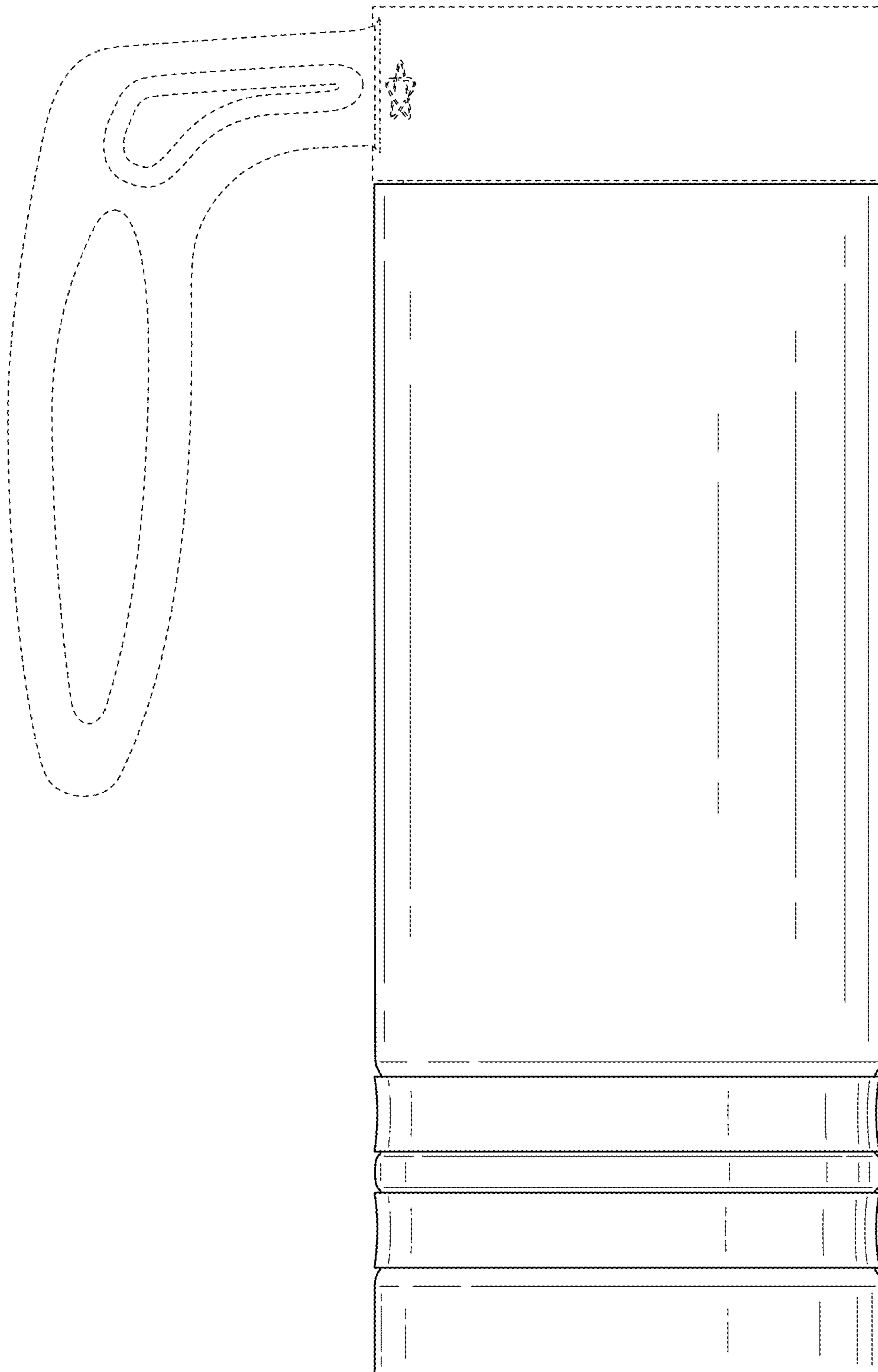

FIG. 5

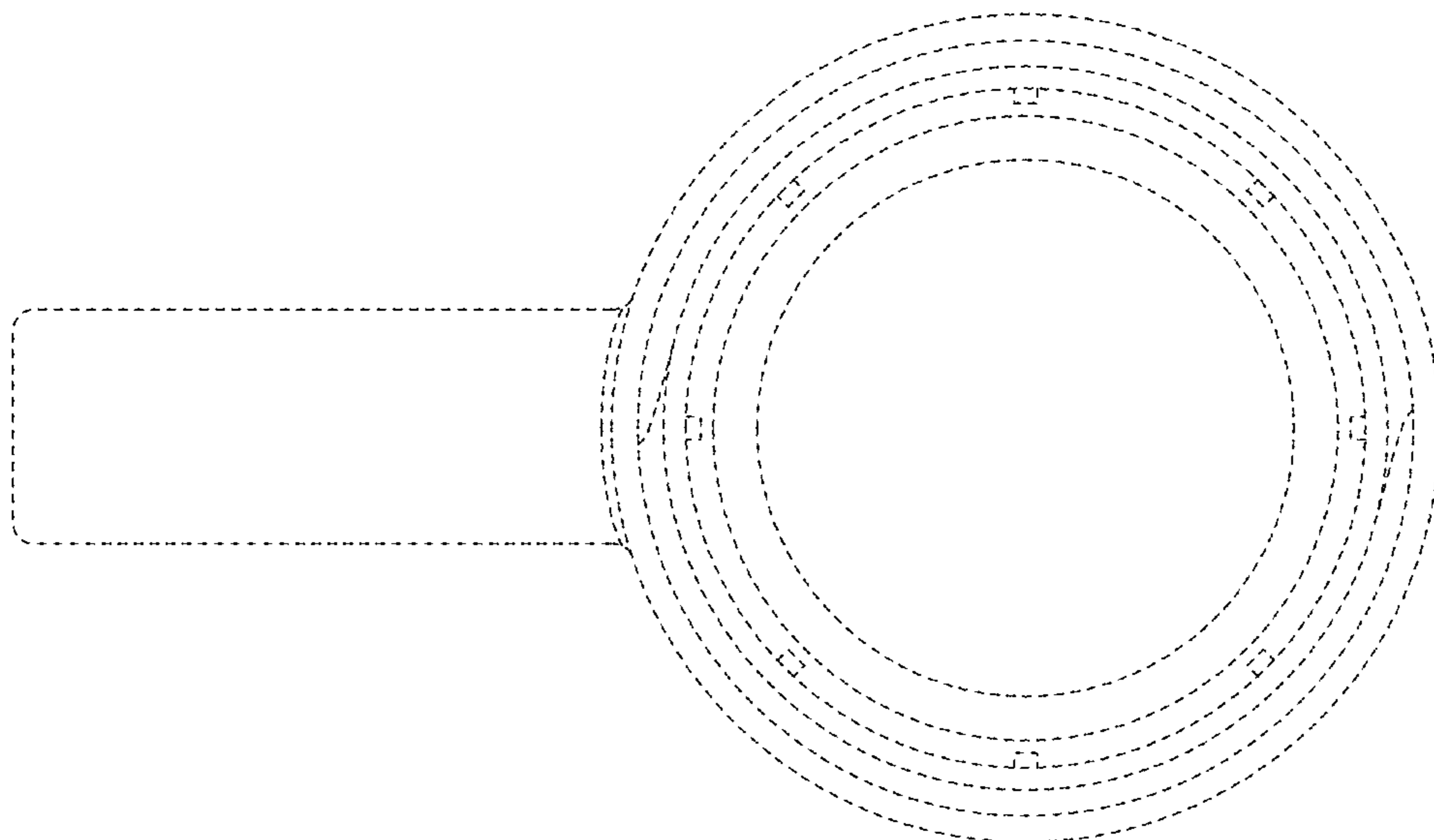

FIG. 6

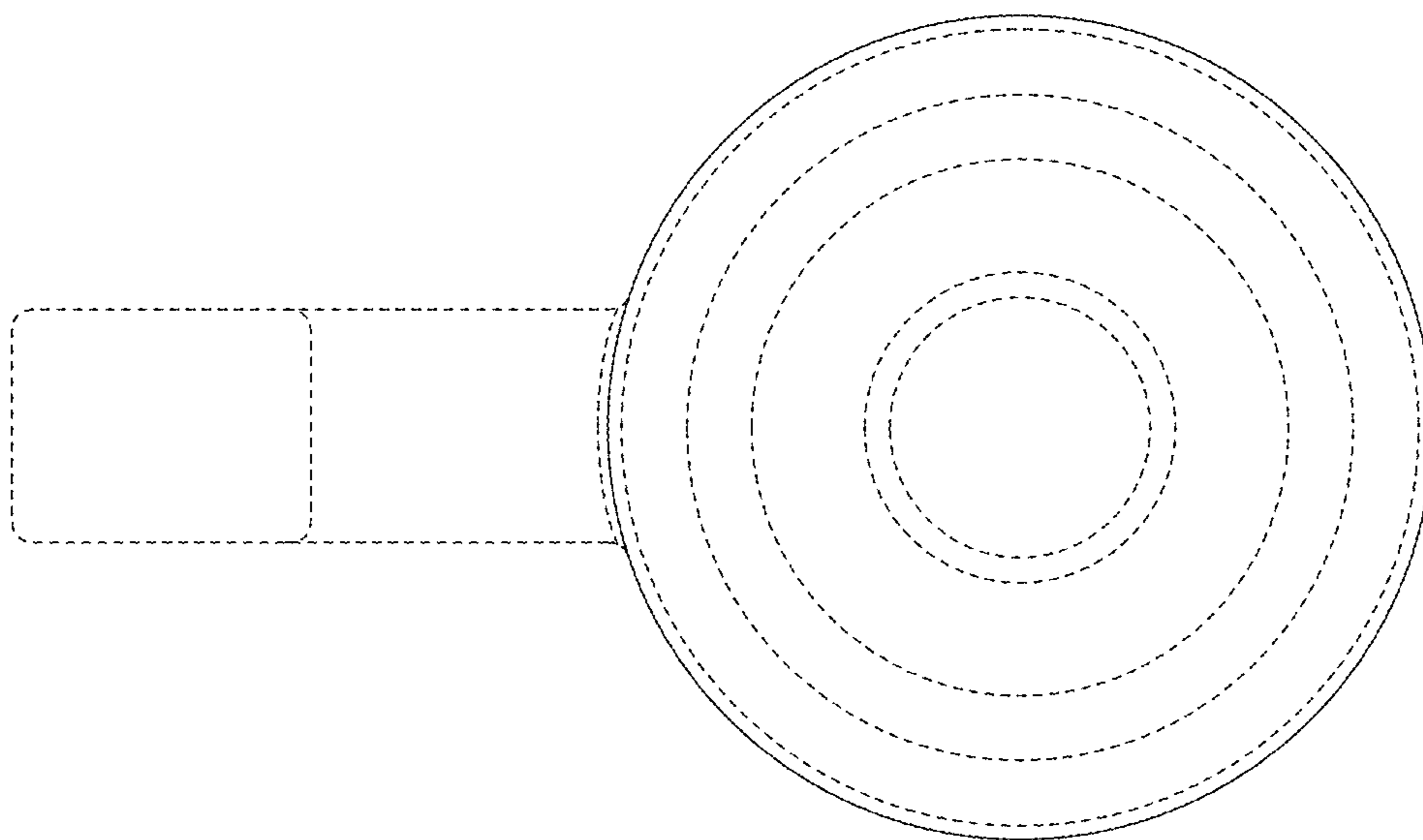

FIG. 7

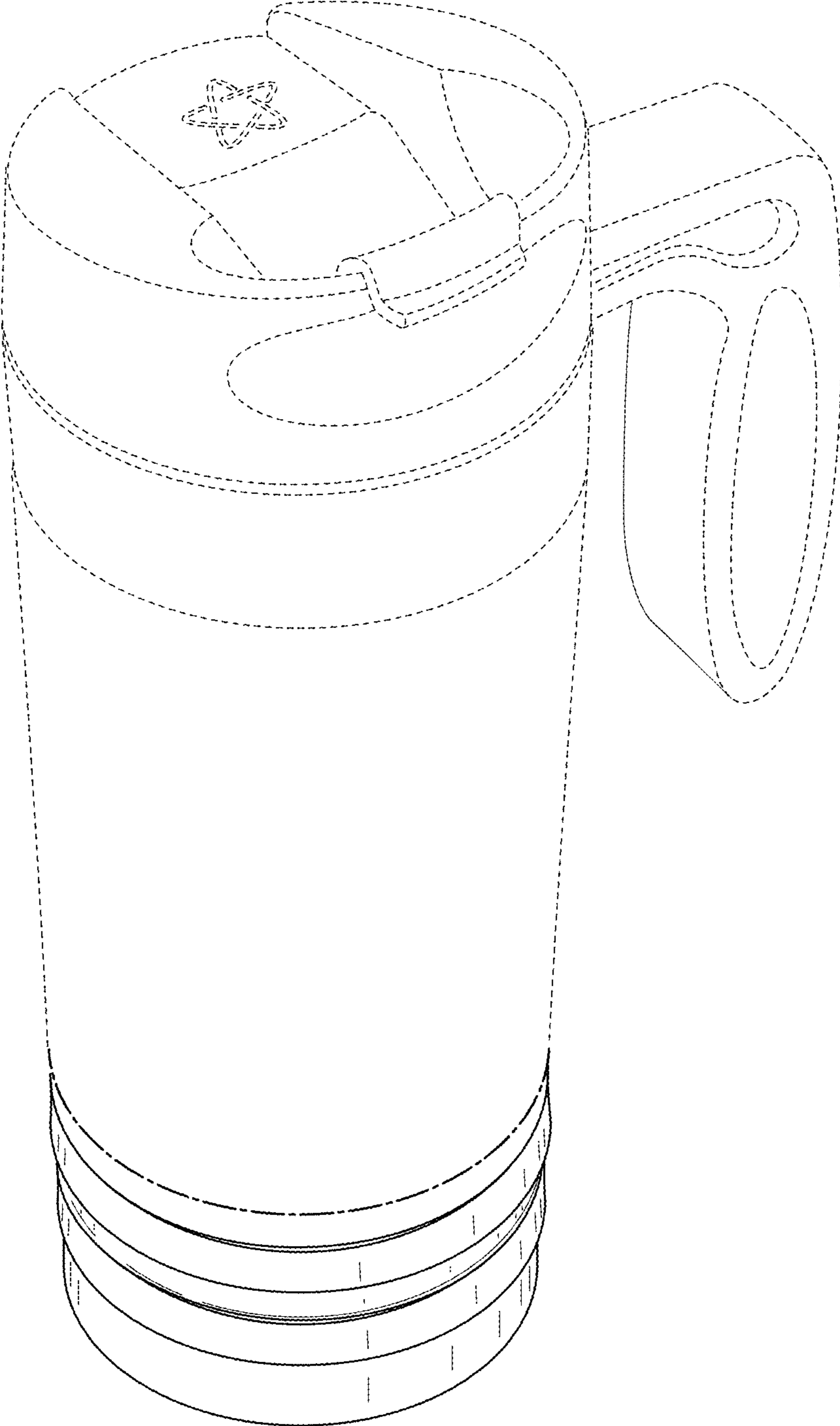

FIG. 8

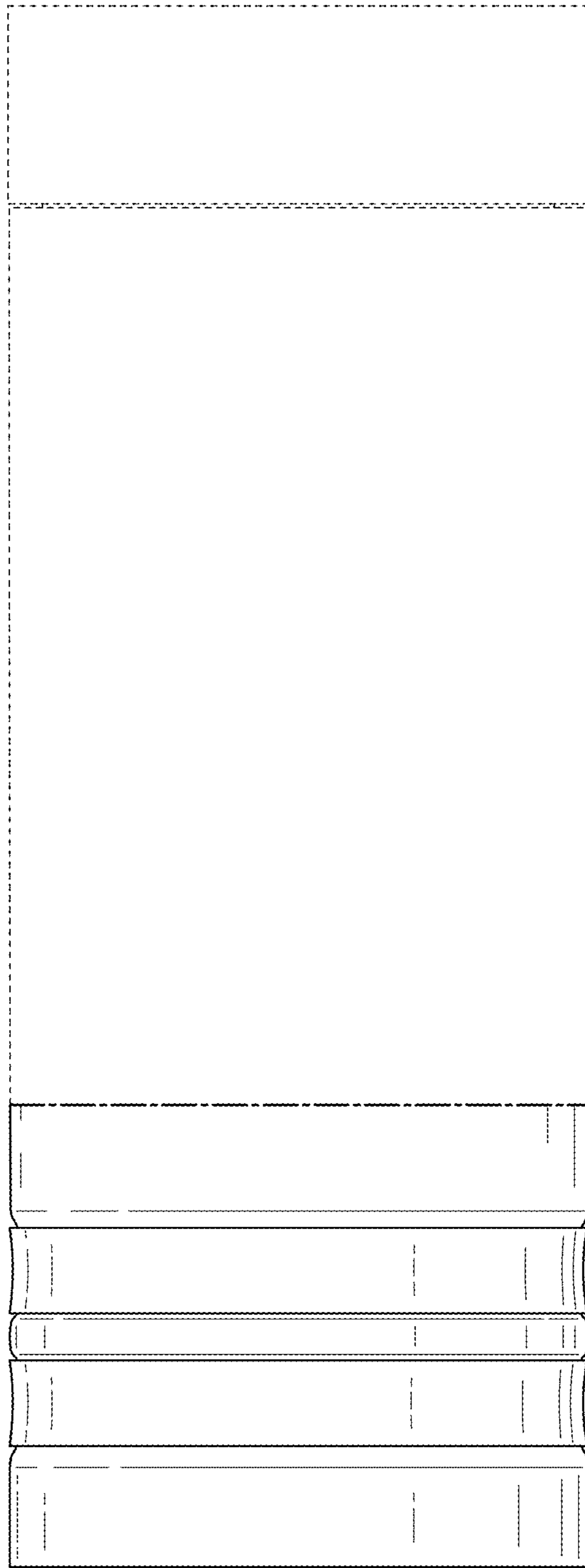

FIG. 9

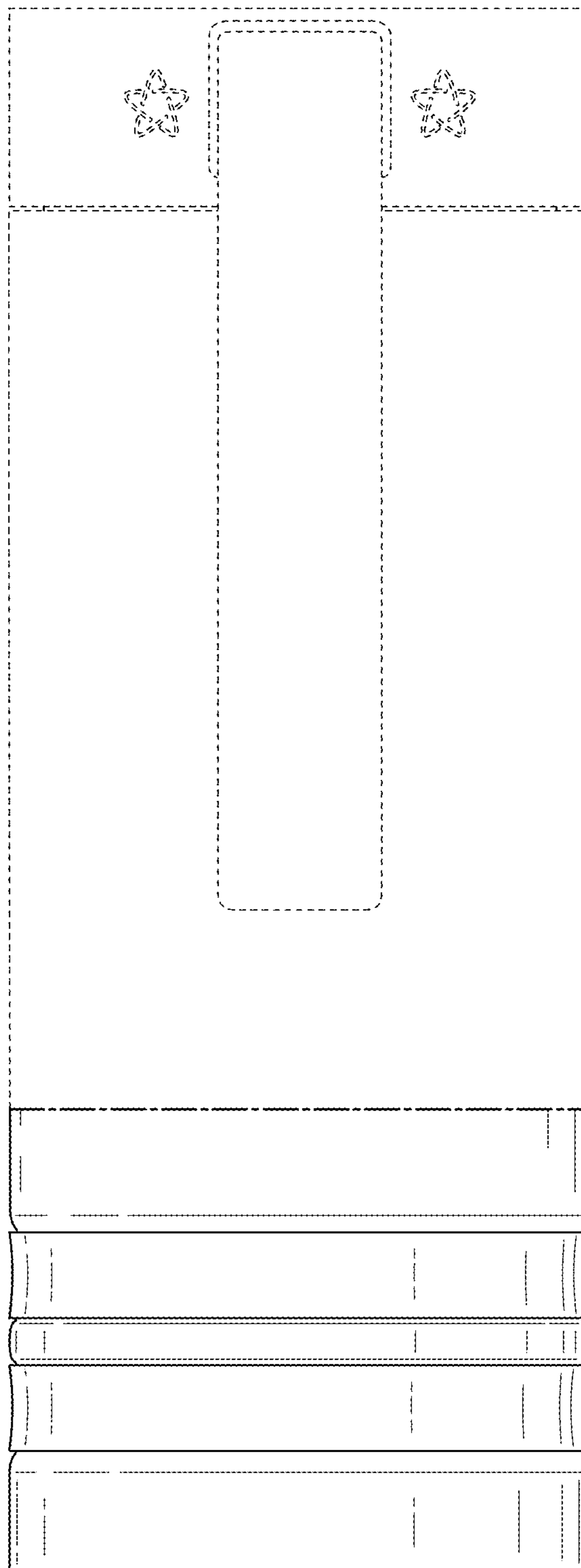

FIG. 10

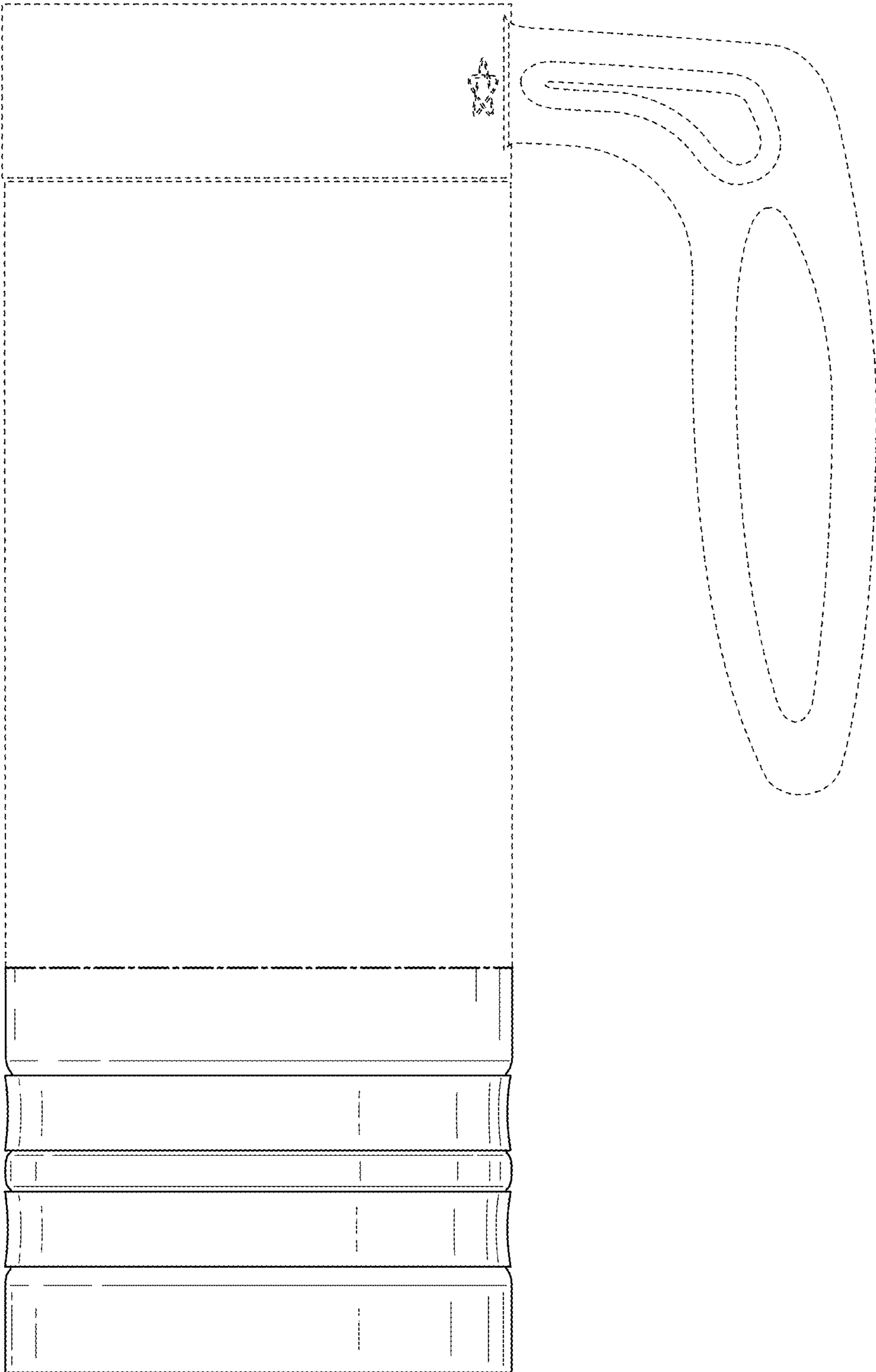

FIG. 11

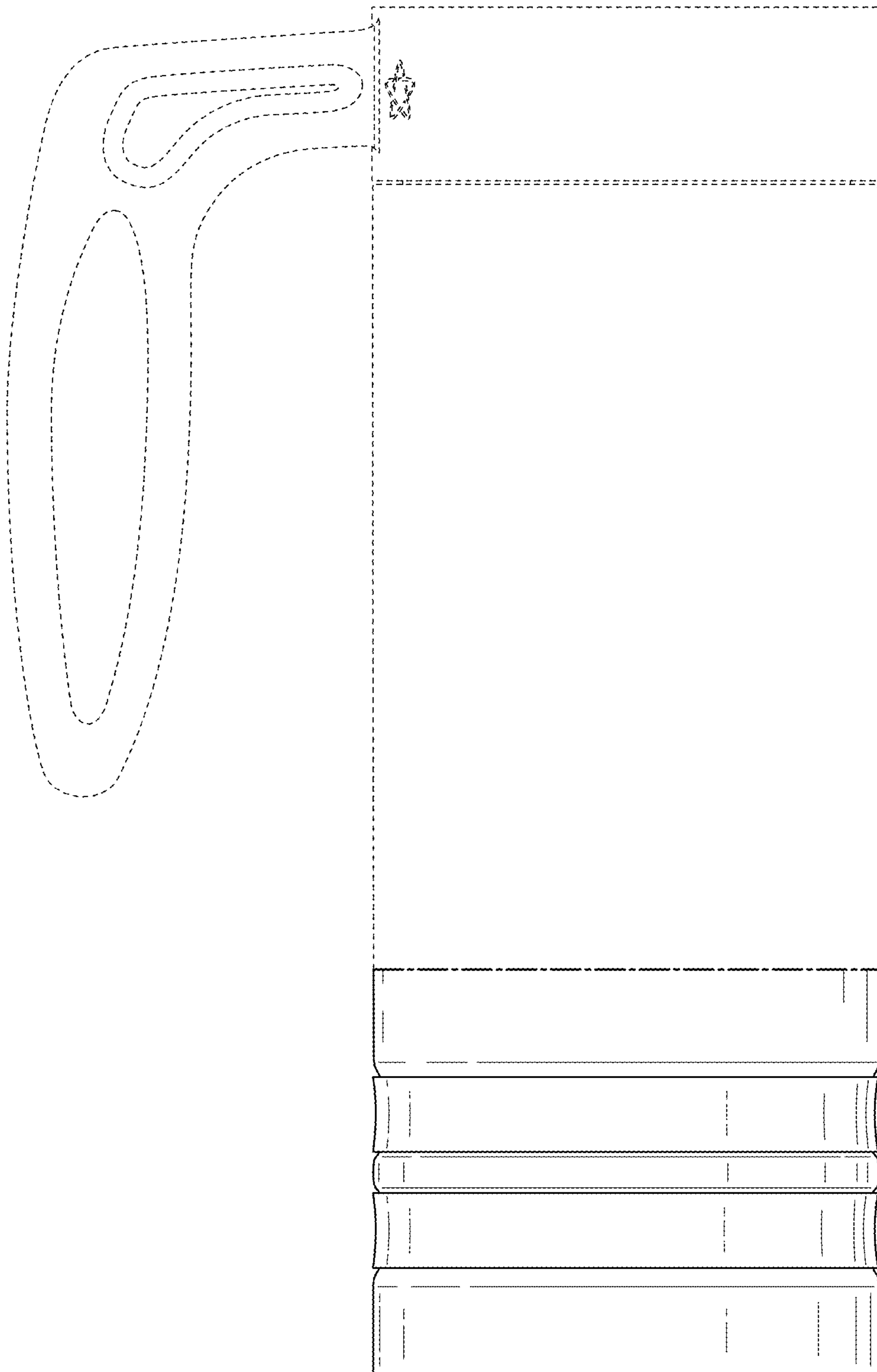

FIG. 12

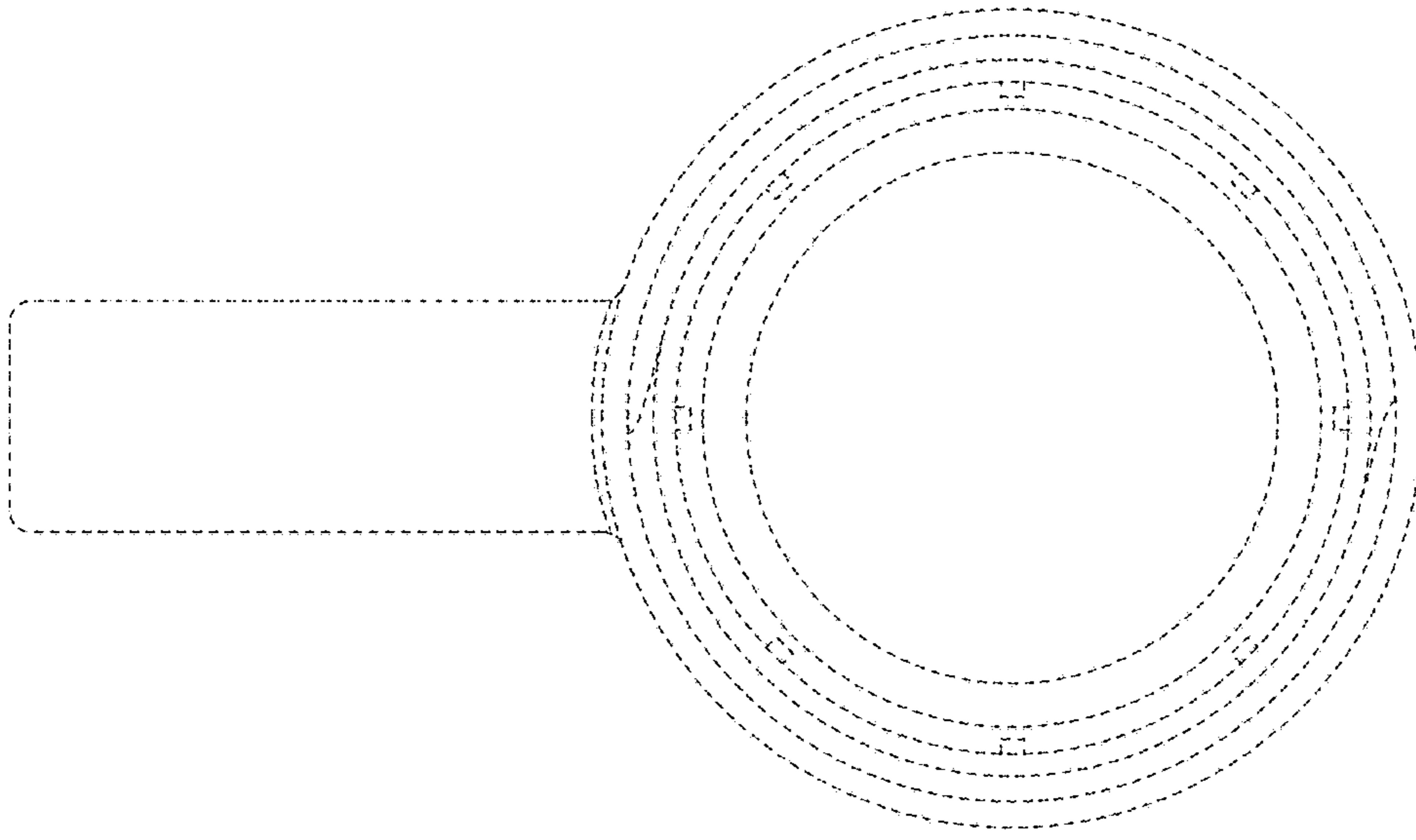

FIG. 13

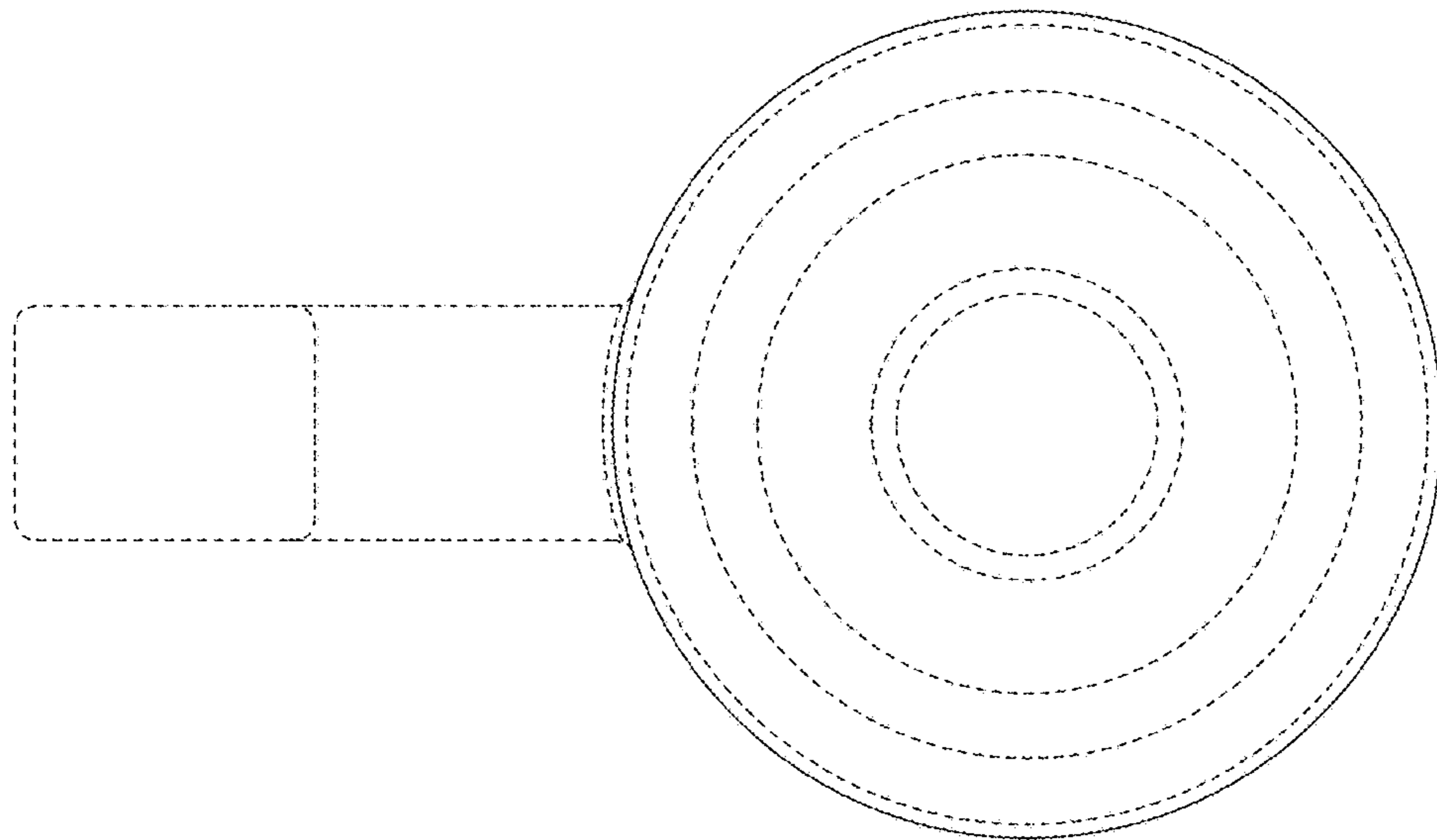

FIG. 14

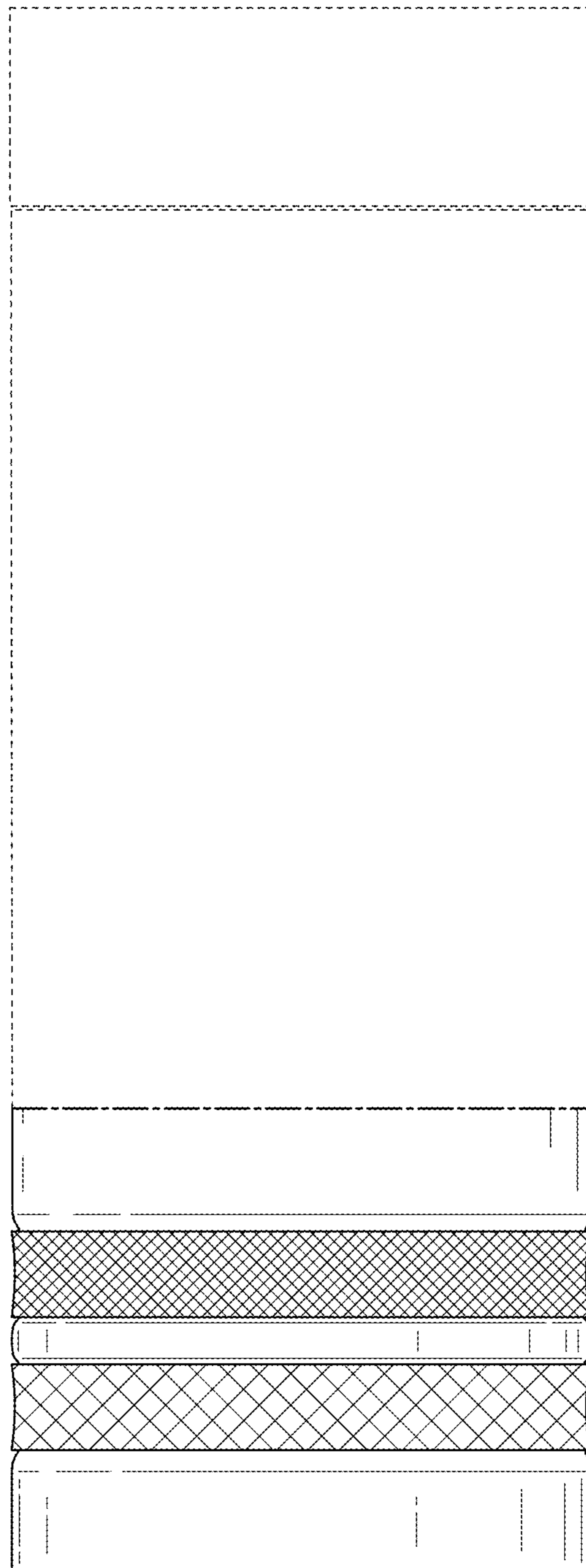

FIG. 15