



US00D796261S

(12) **United States Design Patent** (10) **Patent No.:** **US D796,261 S**
Khalifa et al. (45) **Date of Patent:** **** *Sep. 5, 2017**

(54) **BOTTLE**

FOREIGN PATENT DOCUMENTS

(71) Applicant: **Seventh Generation Ventures, Inc.**,
Burlington, VT (US)

WO 9904667 2/1999
WO 9936152 8/1999
WO 0068151 11/2000

(72) Inventors: **Aly Khalifa**, Raleigh, NC (US);
Derrick Paul Lawrence, South
Burlington, VT (US)

OTHER PUBLICATIONS

“Katadyn Micro Bottle Water Filter”, DPCI: 242-04-9316, ASIN:
B0000FB46U, Catalog #10545684.

(73) Assignee: **Seventh Generation Ventures, Inc.**,
Burlington, VT (US)

(Continued)

(*) Notice: This patent is subject to a terminal dis-
claimer.

Primary Examiner — Marianne Pandozzi

Assistant Examiner — Jae Liang

(74) *Attorney, Agent, or Firm* — Justin W. McCabe;
Dunkiel Saunders Elliott Raubvogel & Hand, PLLC

(**) Term: **14 Years**

(57) **CLAIM**

(21) Appl. No.: **29/517,576**

The ornamental design for a bottle, as shown and described.

(22) Filed: **Feb. 13, 2015**

DESCRIPTION

(51) **LOC (10) Cl.** **07-01**

(52) **U.S. Cl.**
USPC **D7/510**; D7/511; D7/536; D7/392.1;
D9/500

FIG. 1 is a perspective view of a bottle showing our new
design;

FIG. 2 is a front view thereof;

FIG. 3 is a rear view thereof;

FIG. 4 is a right side view thereof;

FIG. 5 is a left side view thereof;

FIG. 6 is a top plan view thereof;

FIG. 7 is a bottom view thereof;

FIG. 8 is a top perspective view of the closure portion of a
bottle with the bottle portion removed for ease of illustra-
tion;

FIG. 9 is a first bottom perspective view thereof;

FIG. 10 is second bottom perspective view thereof;

FIG. 11 is a front view thereof;

FIG. 12 is a rear view thereof;

FIG. 13 is a right side view thereof;

FIG. 14 is a left side view thereof;

FIG. 15 is a top plan view thereof; and,

FIG. 16 is a bottom plan view thereof.

(58) **Field of Classification Search**

USPC D7/507, 509, 510, 511, 513, 523, 529,
D7/532, 533, 534, 300, 300.1, 591, 608,
D7/392, 392.1, 396.1, 396.2, 900;
D9/500, 501, 502, 503, 504, 516, 517,
D9/525, 435, 436, 440, 442, 443, 449,
D9/434, 556, 438, 538, 447, 445, 563,
D9/554, 550, 546, 545, 446; D3/202;
222/480, 507, 546, 548, 553; 220/210,

(Continued)

(56) **References Cited**

U.S. PATENT DOCUMENTS

D217,585 S 5/1970 Lambelet
D249,111 S * 8/1978 Geyer D7/523

(Continued)

1 Claim, 13 Drawing Sheets

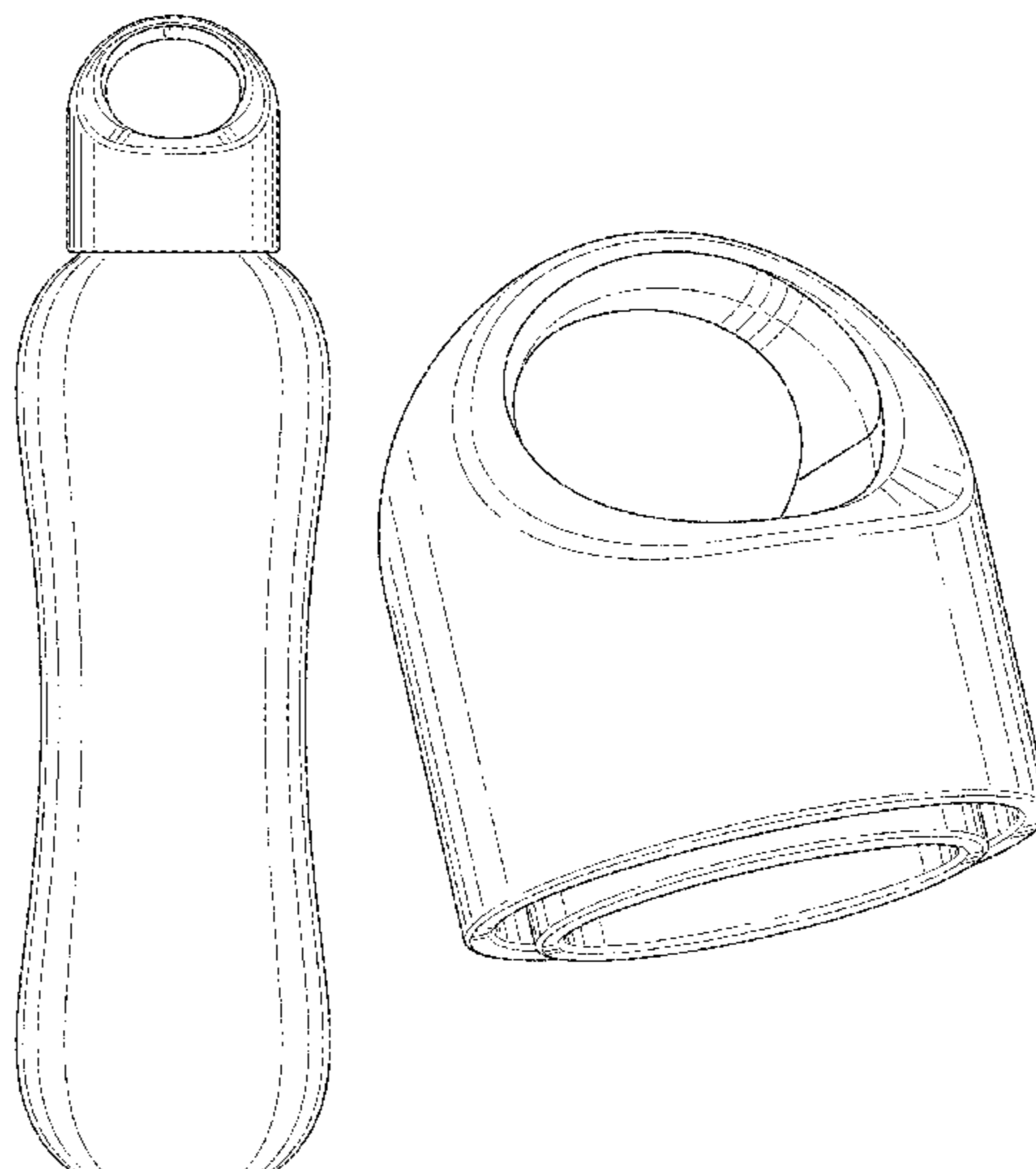

(58) **Field of Classification Search**

USPC 220/212.5, 703, 709, 711, 523, 288,
220/710.5, 717, 200; 215/12.1, 216, 11.4,
215/11.5, 11.1
CPC B65D 23/02; B65D 39/0052; B65D 39/0082;
B65D 39/0076; B65D 39/007; B65D
43/0277; B65D 43/0279; B65D 43/0285;
B65D 43/12; A61J 2205/20; A61J
2200/72; A61J 9/02; A61J 9/08
See application file for complete search history.

(56) **References Cited**

U.S. PATENT DOCUMENTS

D313,075 S 12/1990 Mariol
D333,268 S 2/1993 Arlinghaus et al.
5,211,973 A 5/1993 Nohren
D356,160 S 3/1995 Cautereels
5,518,143 A 5/1996 Iodice
5,609,759 A 3/1997 Nohren et al.
5,681,463 A 10/1997 Shimizu et al.
D408,221 S * 4/1999 Asberg D7/511
D409,444 S * 5/1999 Pelz D7/509
D412,281 S 7/1999 Lindsay et al.
5,928,512 A 7/1999 Hatch et al.
6,004,460 A 12/1999 Palmer et al.
D428,339 S 7/2000 Johnston et al.
D428,813 S 8/2000 Haley
6,165,382 A 12/2000 Perez Mendez et al.
D436,501 S * 1/2001 Huang D7/608
D437,229 S 2/2001 Andrew
D440,318 S 4/2001 Meyers et al.
D456,714 S 5/2002 Brauner et al.
6,569,329 B1 5/2003 Nohren
D482,607 S * 11/2003 McRae D9/443
D501,140 S 1/2005 Fung et al.
D502,844 S 3/2005 Rohe
D505,329 S 5/2005 Wadalawala et al.
D513,185 S * 12/2005 Ruiz D1/105
D520,363 S 5/2006 Perez
D526,565 S 8/2006 Griffin et al.
D531,903 S 11/2006 Haubein
D532,311 S 11/2006 Yourist
D538,597 S 3/2007 Kim
D542,598 S * 5/2007 Karp D7/510
D556,038 S 11/2007 Chupak
D571,213 S * 6/2008 Le Bras-Brown D9/500
D571,662 S 6/2008 Clark et al.
D572,585 S * 7/2008 Perrin D9/443
D579,775 S 11/2008 Dixon et al.
D580,708 S 11/2008 George
D582,774 S 12/2008 Klemm et al.
D584,107 S 1/2009 George
D591,154 S 4/2009 Darr et al.
D595,417 S 6/2009 Driver et al.
D602,369 S 10/2009 Potts et al.
7,614,512 B2 11/2009 Nader
D608,642 S 1/2010 Black

D615,360 S 5/2010 Joy et al.
D616,743 S * 6/2010 Cresswell D9/443
D616,744 S * 6/2010 Cresswell D9/443
D620,361 S * 7/2010 Scott D9/500
D620,758 S * 8/2010 Smiedt D7/523
D620,798 S * 8/2010 Cresswell D9/443
D621,258 S * 8/2010 Gullickson D9/443
D621,660 S * 8/2010 Smiedt D7/510
D626,416 S * 11/2010 Cresswell D7/510
D631,285 S 1/2011 Smiedt et al.
D631,286 S 1/2011 Smiedt et al.
D631,666 S * 2/2011 Lim D4/129
D635,457 S * 4/2011 Lane D7/510
D638,695 S * 5/2011 Woodrow D8/382
D647,369 S * 10/2011 Bryman D7/507
D652,307 S * 1/2012 White D7/509
D657,196 S * 4/2012 Beyers, III D7/513
D659,010 S * 5/2012 Oommen D9/500
D662,360 S * 6/2012 George D7/510
D664,809 S * 8/2012 Eyal D7/510
D665,621 S * 8/2012 Eyal D7/392.1
D674,279 S * 1/2013 Lembke D7/509
D675,100 S * 1/2013 Herbst D7/511
D675,533 S * 2/2013 Oommen D9/500
D682,017 S * 5/2013 Smiedt D7/392.1
D686,453 S 7/2013 Smiedt et al.
D692,277 S * 10/2013 Smiedt D7/510
D692,724 S 11/2013 Smiedt et al.
D693,170 S * 11/2013 Rosbach D7/392.1
D701,730 S * 4/2014 Stanley D7/507
D702,506 S * 4/2014 Mettler D7/608
D708,954 S * 7/2014 Barnes D7/511
D708,956 S * 7/2014 McKay D9/449
D712,255 S * 9/2014 Geis D9/436
D713,365 S * 9/2014 Green D13/183
D723,873 S * 3/2015 Hojo D7/511
D727,682 S * 4/2015 Madvin D7/397
D742,175 S 11/2015 Rashid et al.
2008/0169260 A1 * 7/2008 Hansson F01M 11/0408
215/216
2013/0199989 A1 * 8/2013 Carter A47G 19/2266
210/464

OTHER PUBLICATIONS

“First Office Action”, for Japanese Patent Application No. 2015-017951, dated Apr. 4, 2016.
“Fit & Fresh Filtered Water Bottle”, Target Corp.
“International Search Report and Written Opinion”, International Publication No. WO 00/68151 A3, dated Nov. 16, 2000.
“Pure Water 2GO, Portable Filtered Water”, printed from www.purewater2go.com/bottles.html, Dec, 1, 2009.
“Start Healthy Stay Healthy Resource Center”, “Gerber Graduates Fun Grips Spill Proof Cups”.
Chiang, “Response to First Office Action”, for Japanese Patent Application No. 2015-017951, dated Jun. 23, 2016.
Liang, “First Office Action”, regarding U.S. Appl. No. 29/517,575, dated Sep. 16, 2016.

* cited by examiner

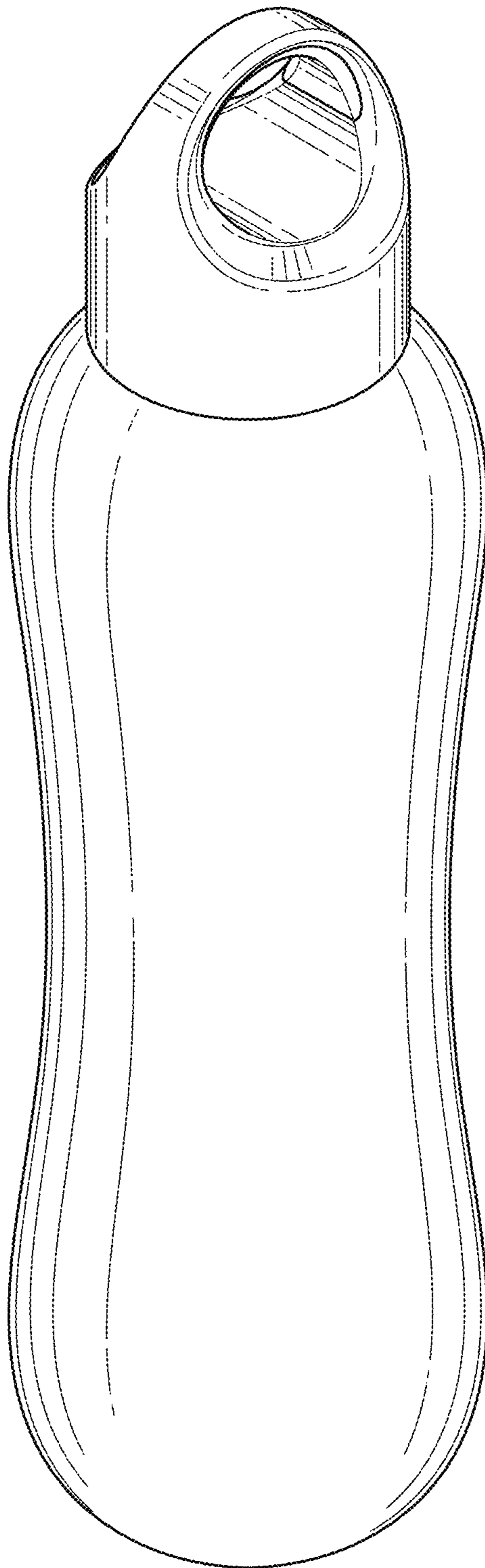

FIG. 1

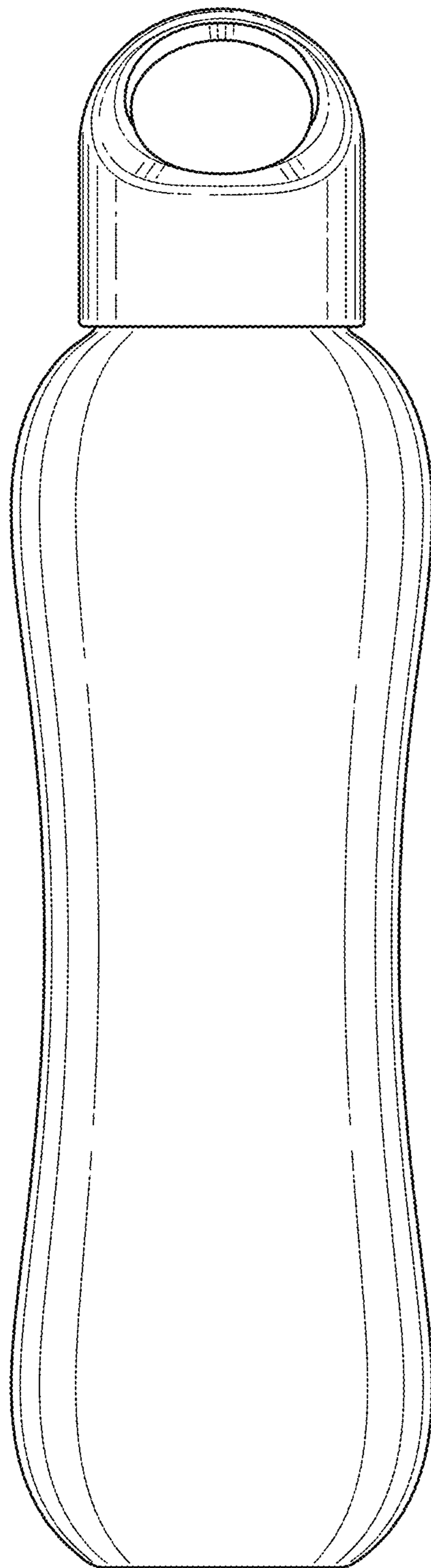

FIG. 2

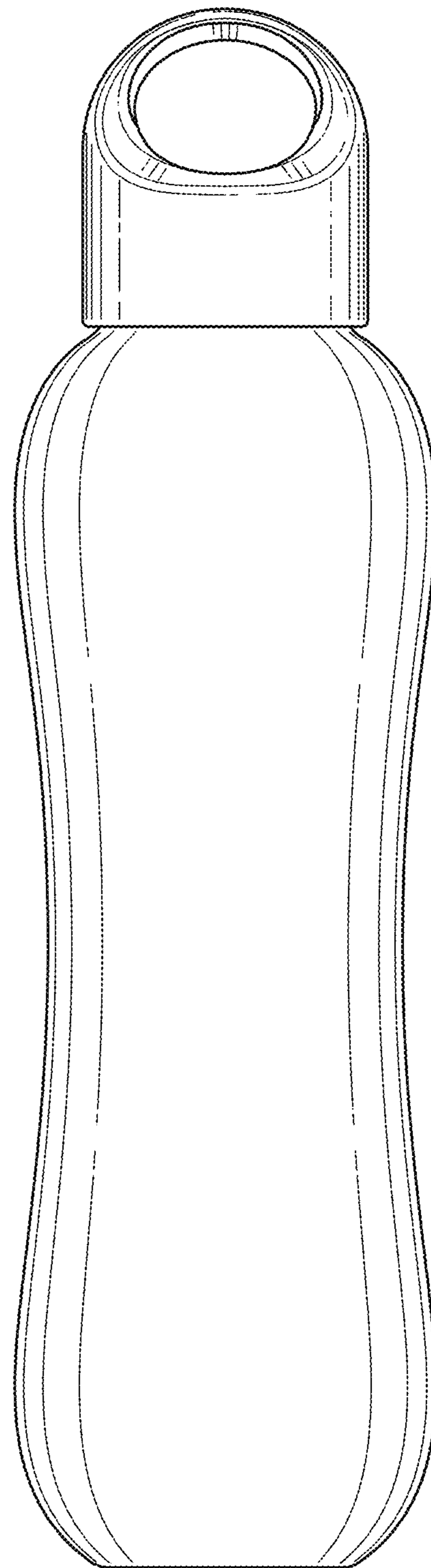

FIG. 3

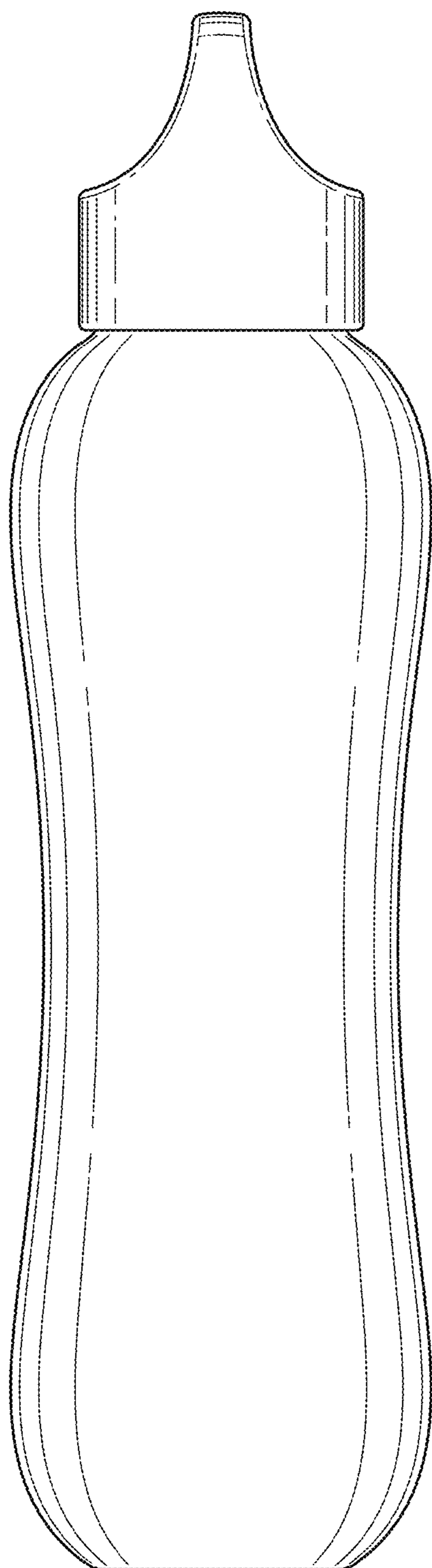

FIG. 4

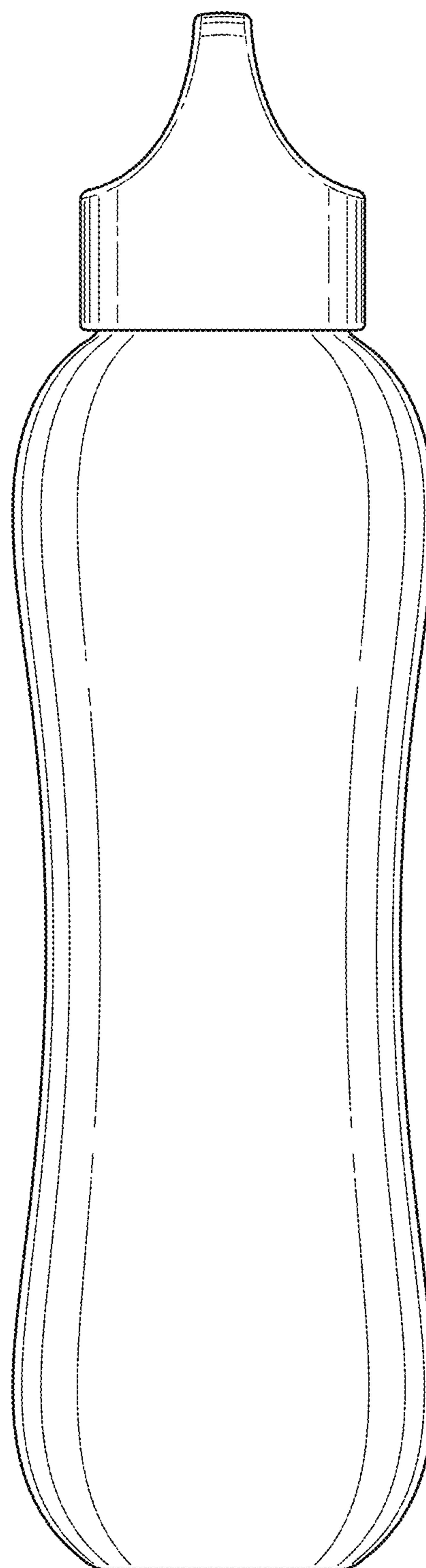

FIG. 5

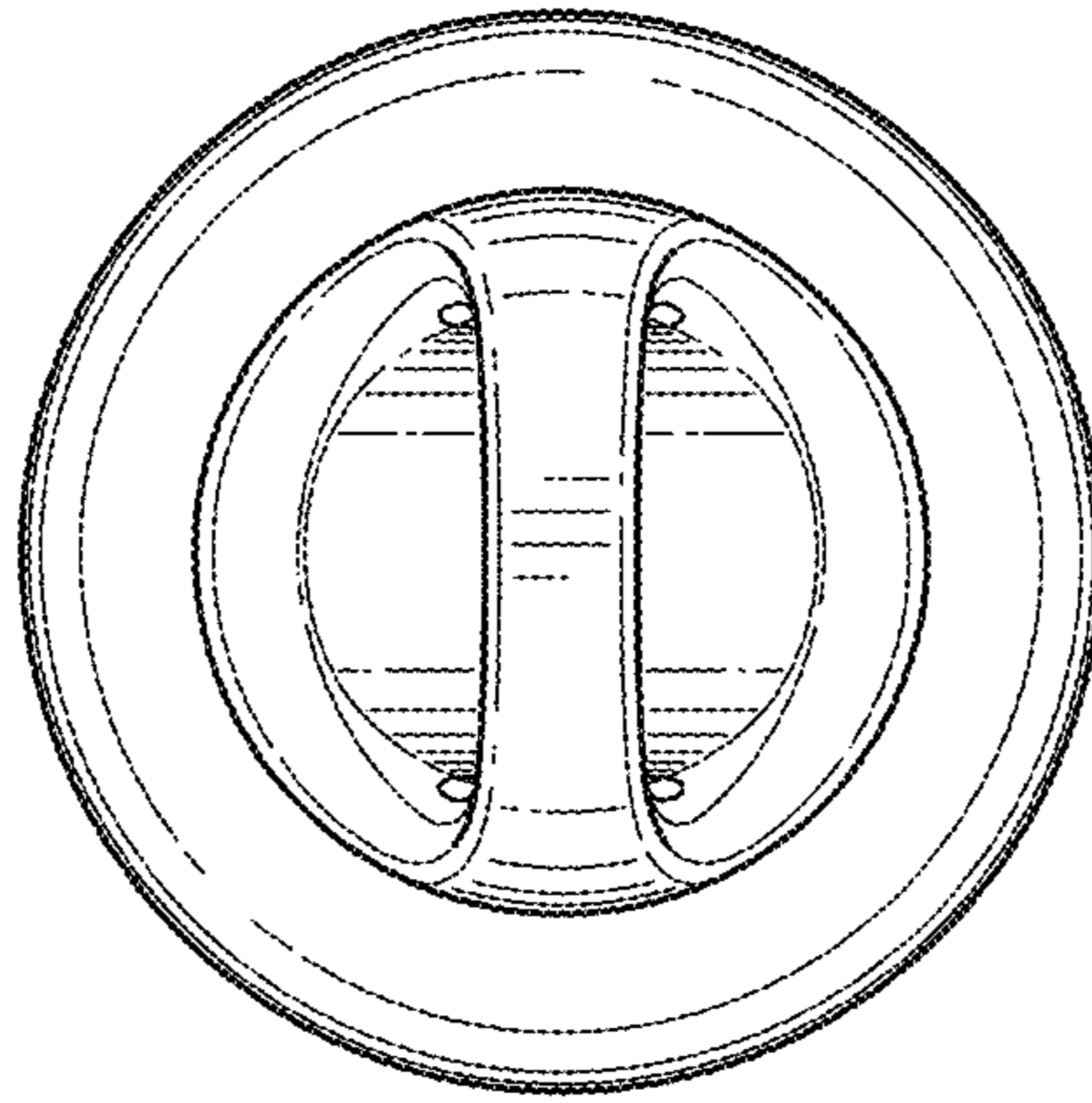

FIG. 6

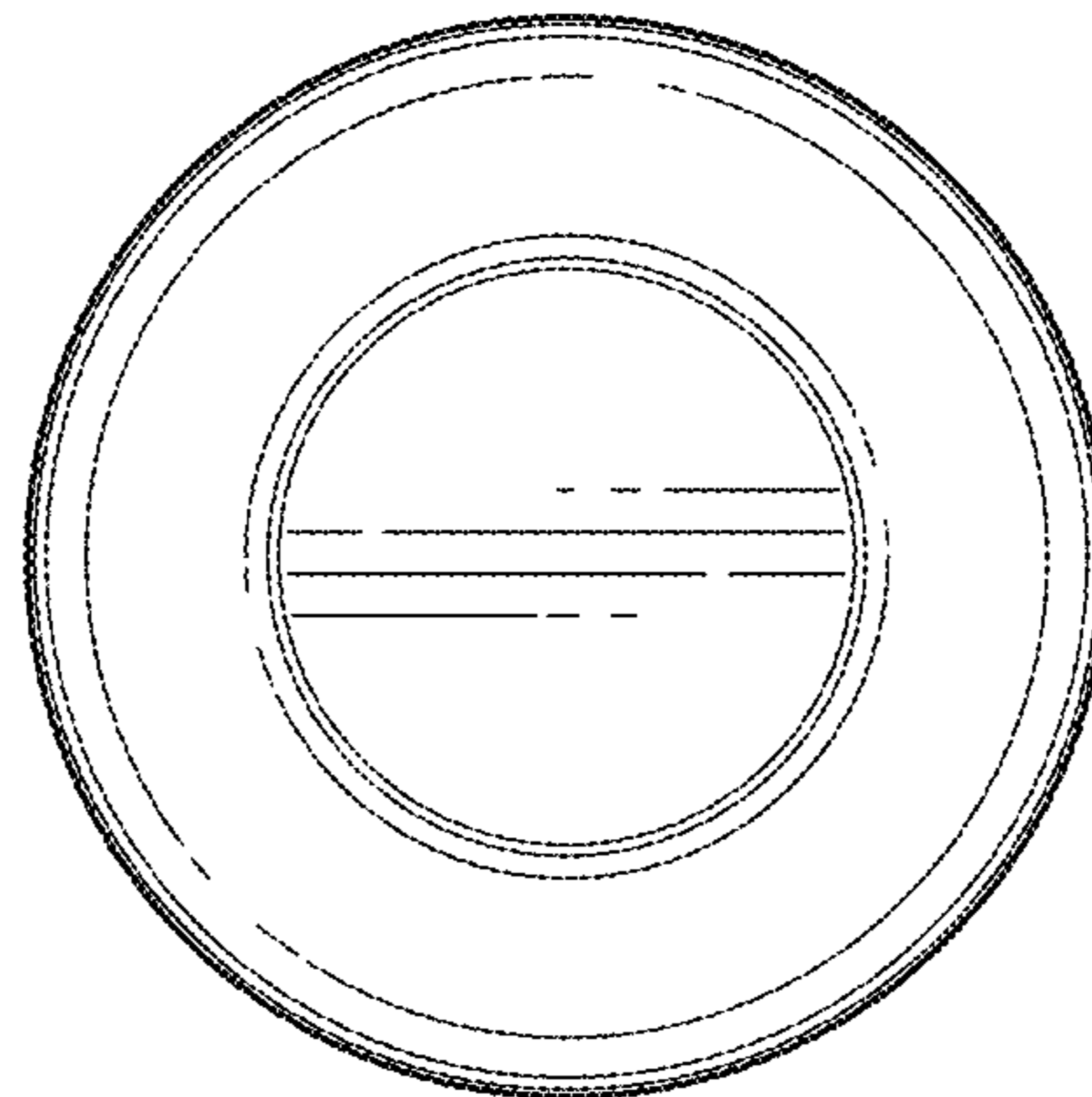

FIG. 7

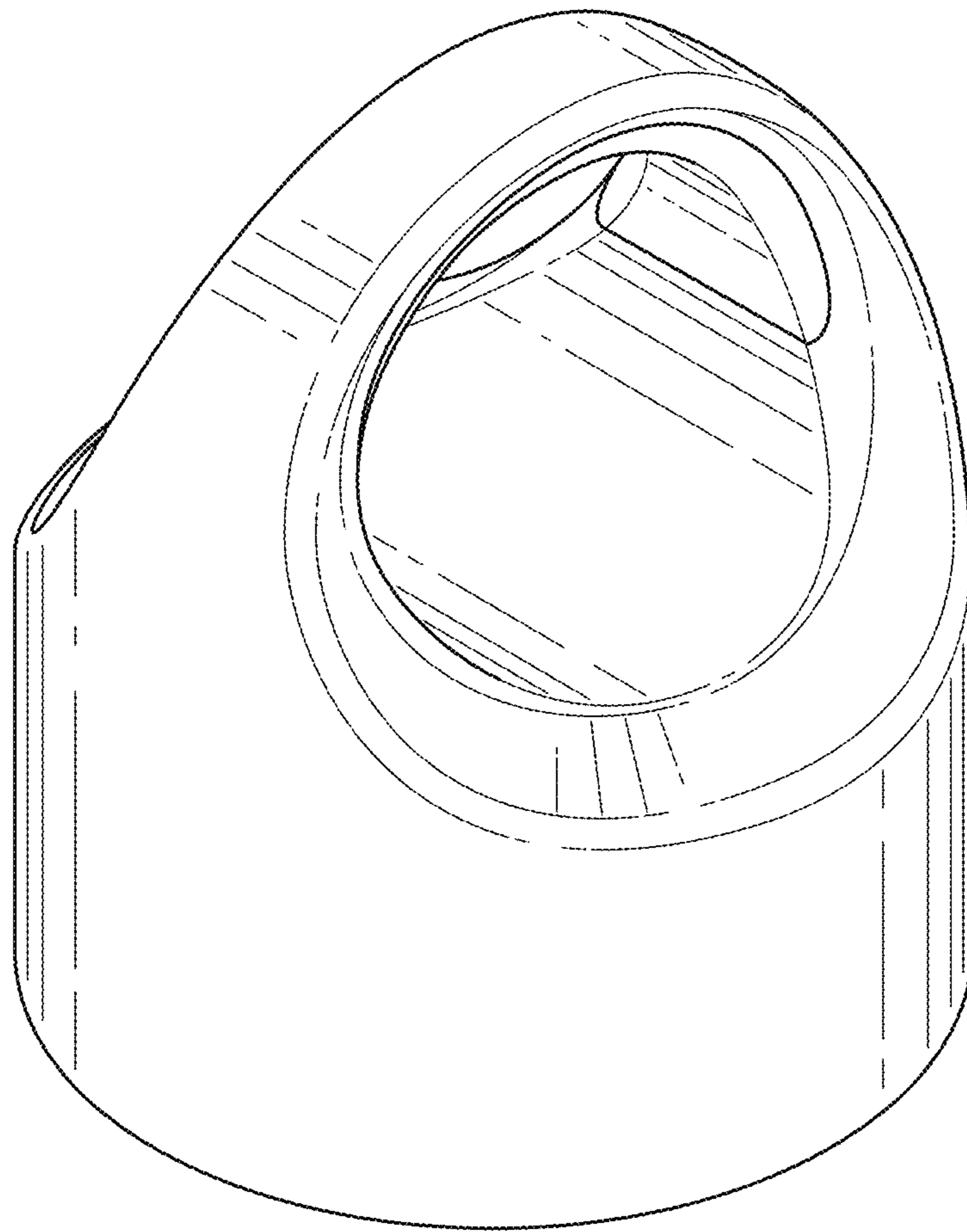

FIG. 8

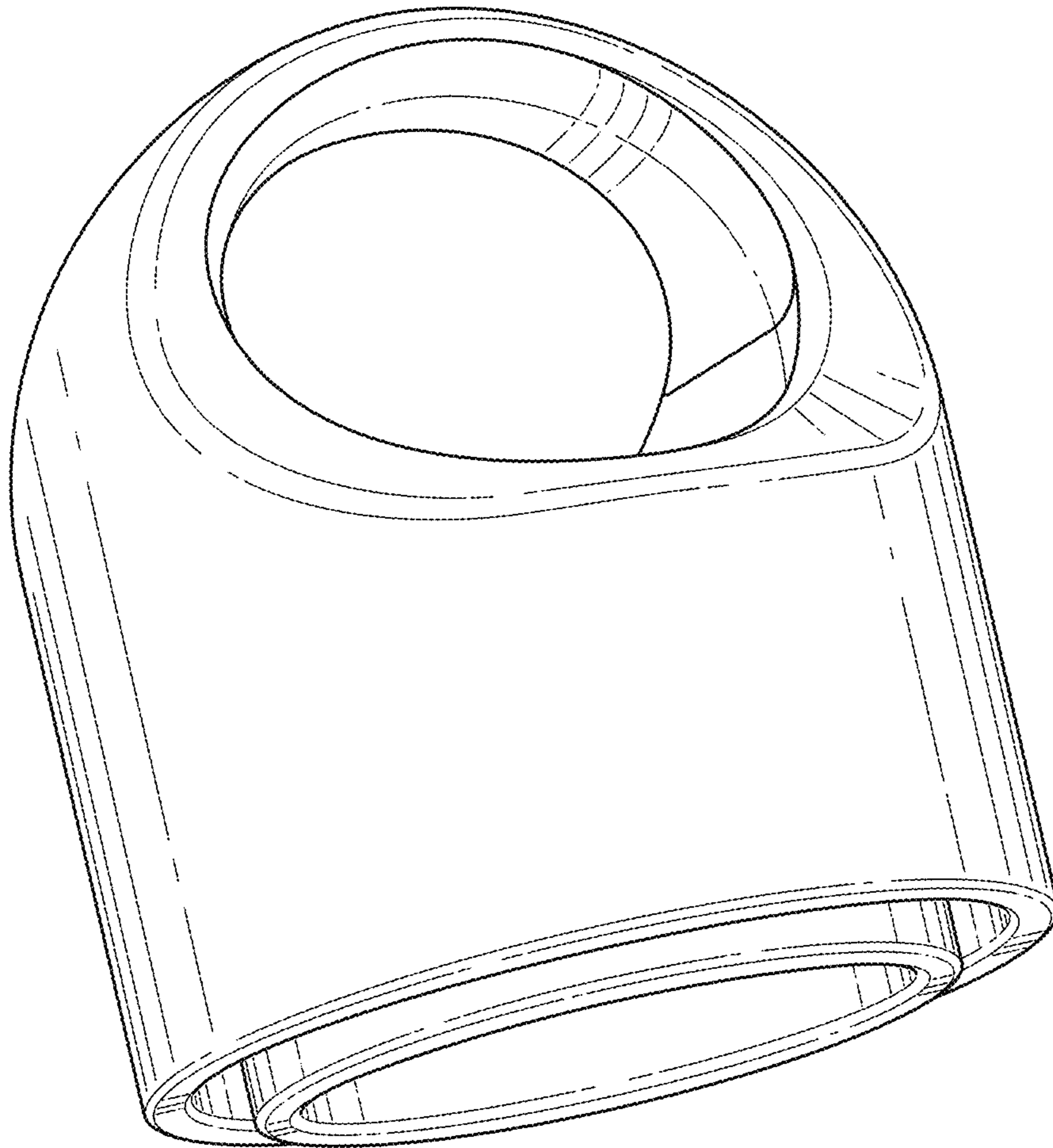

FIG. 9

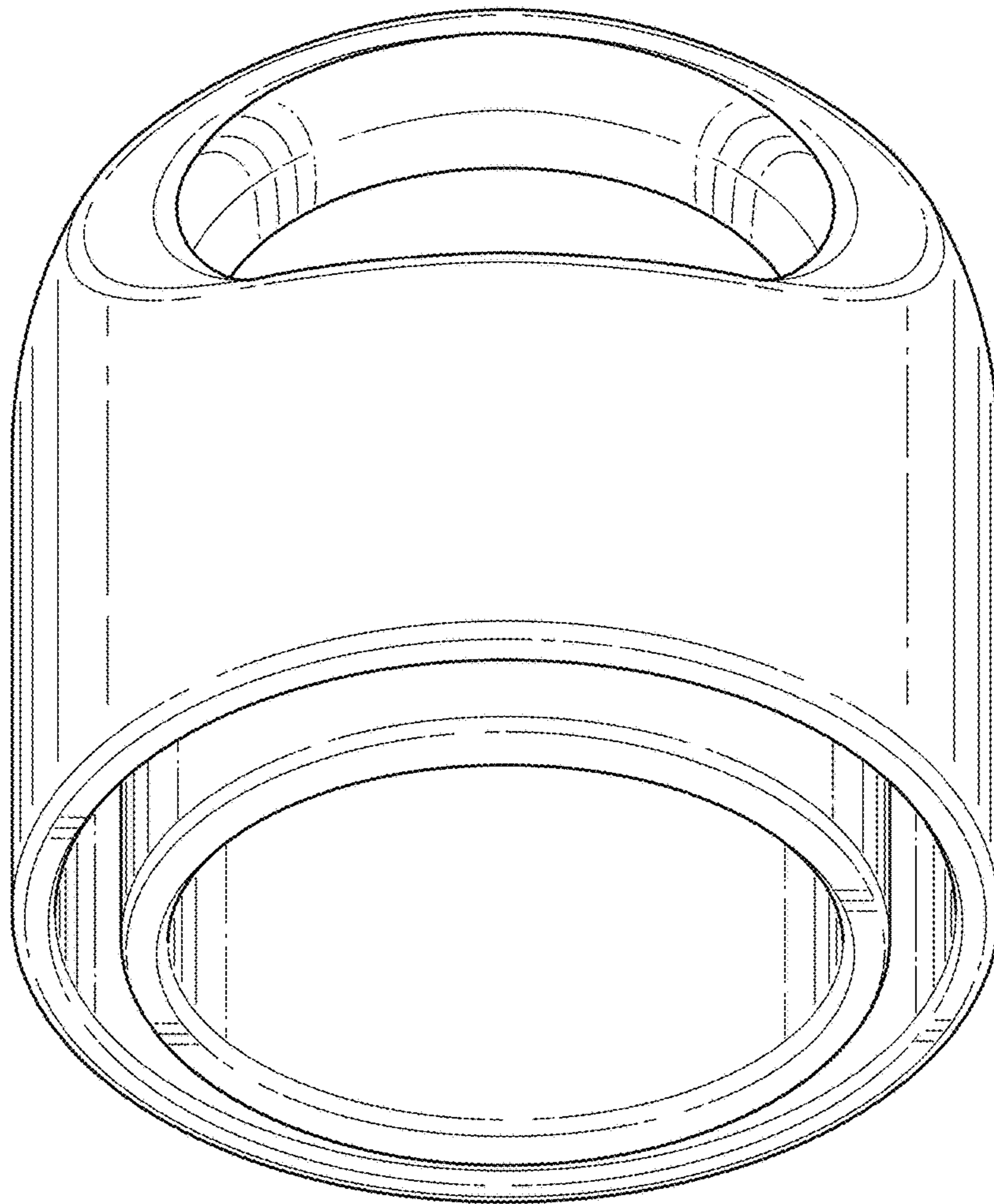

FIG. 10

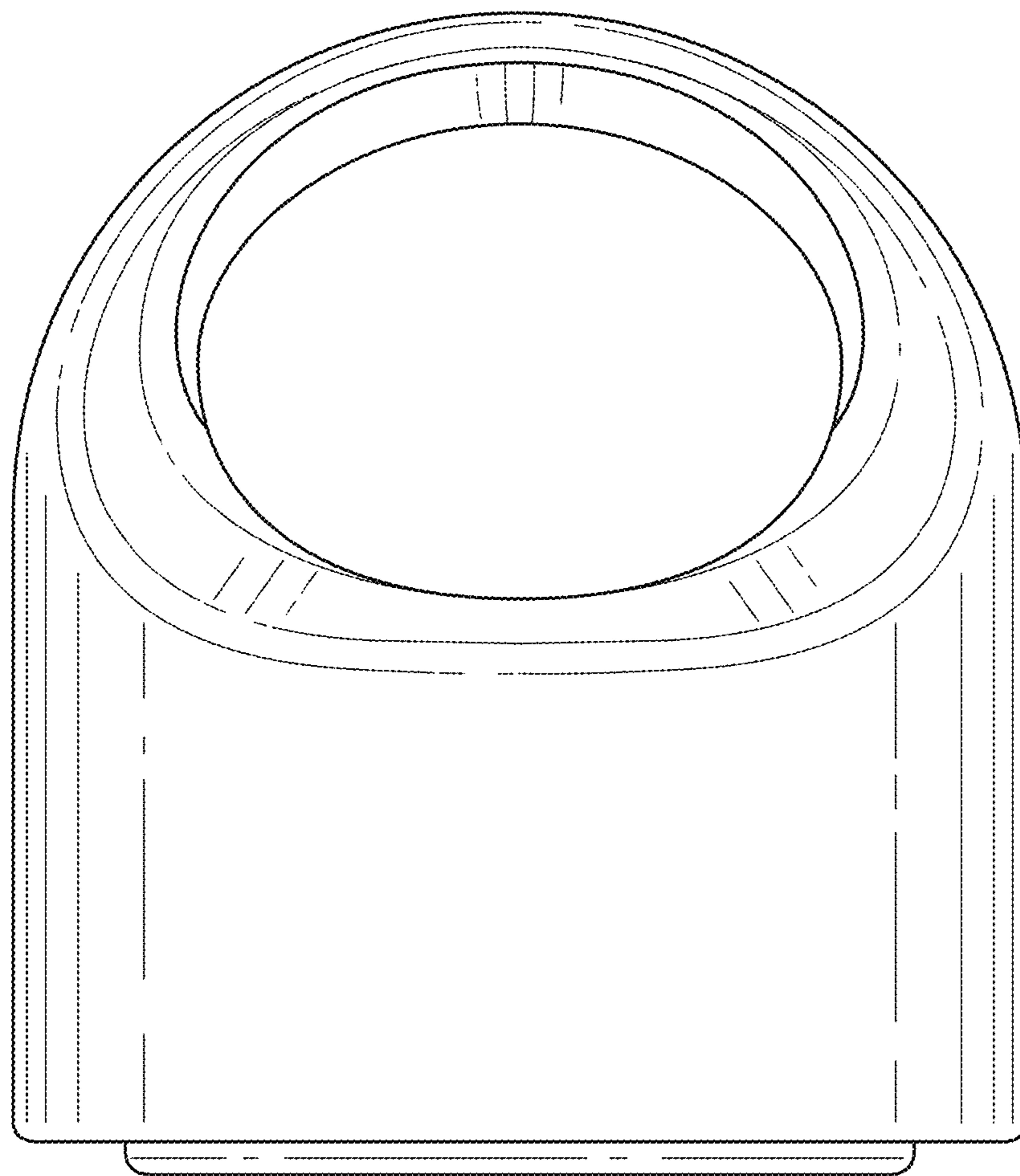

FIG. 11

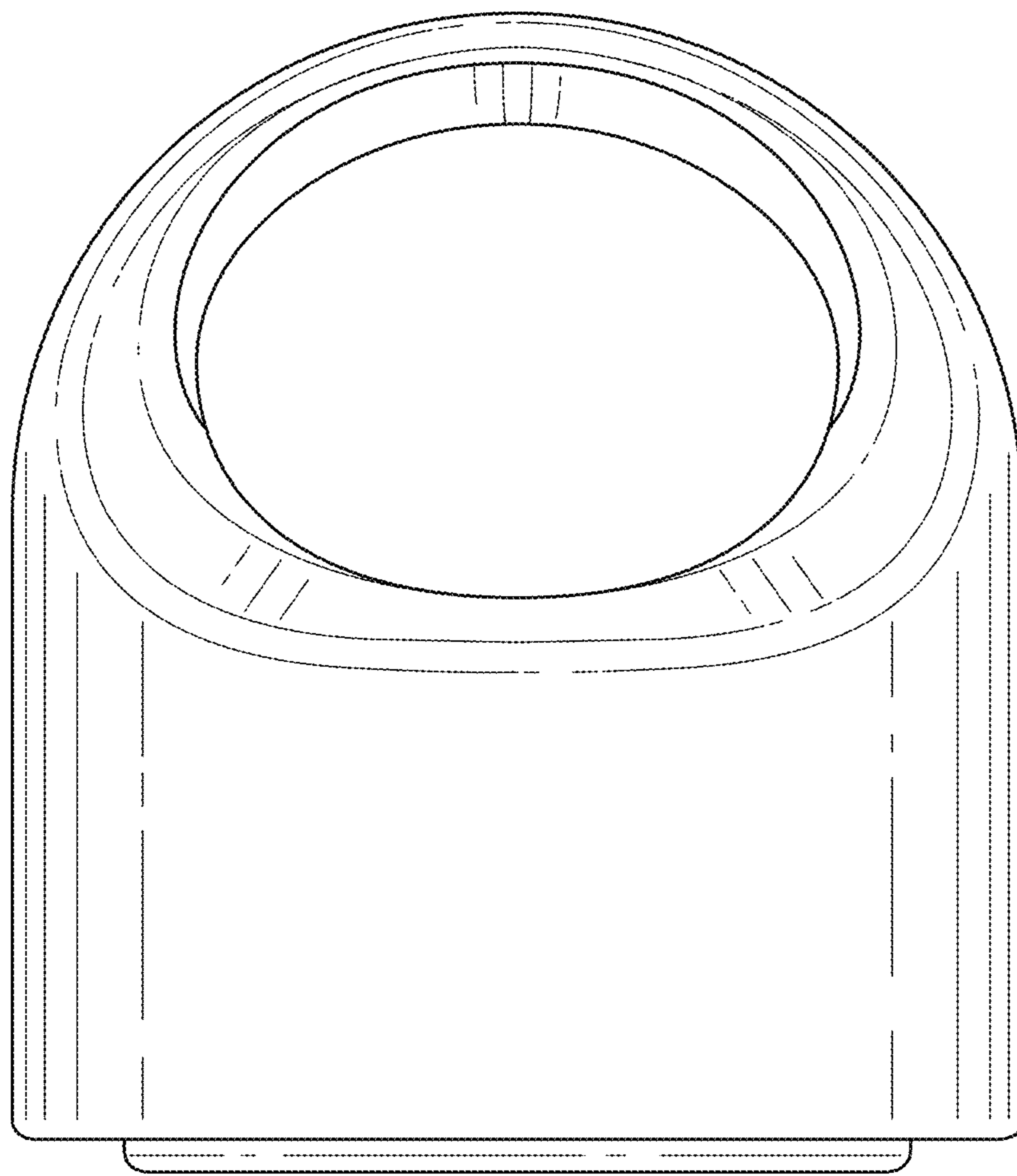

FIG. 12

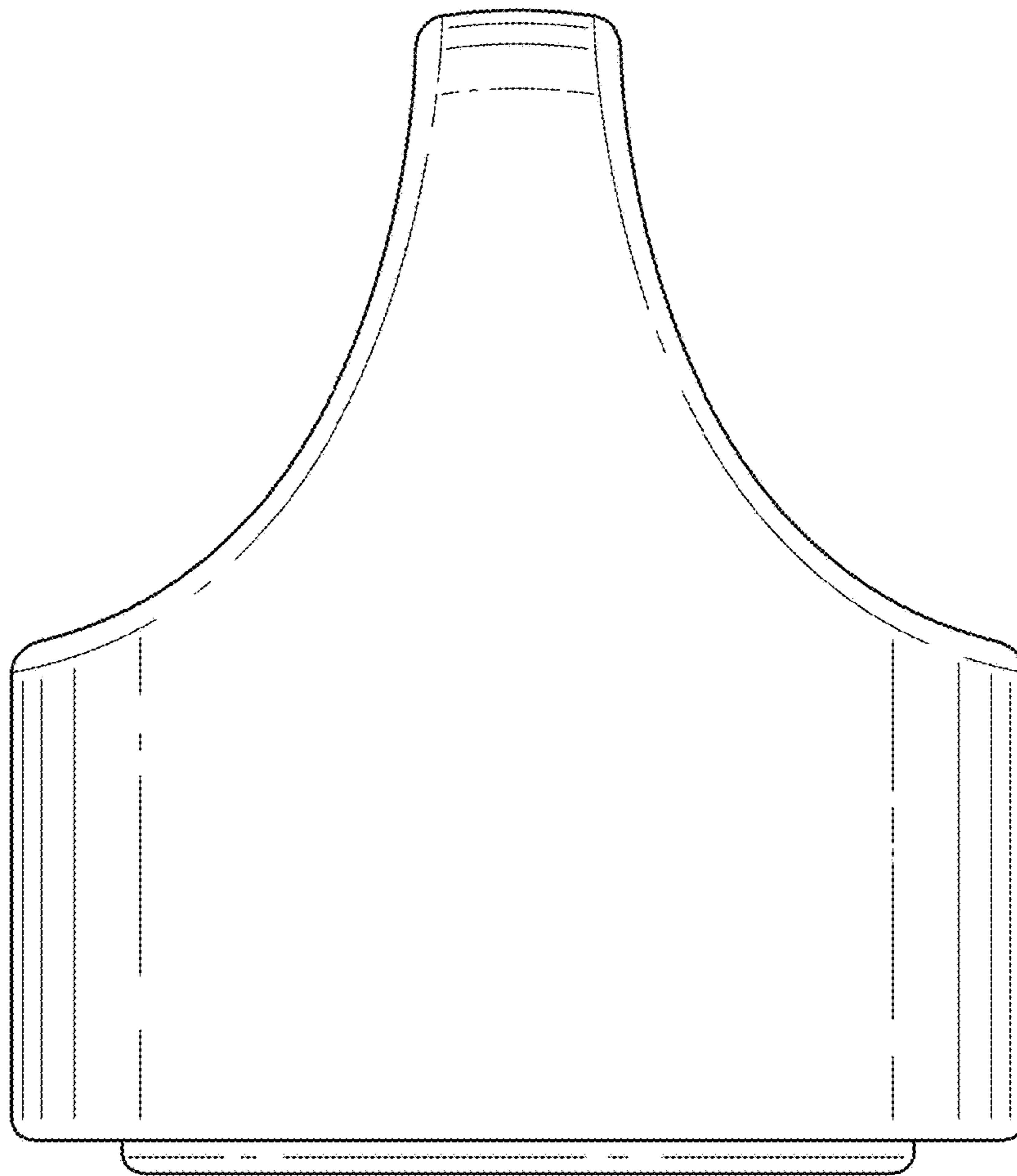

FIG. 13

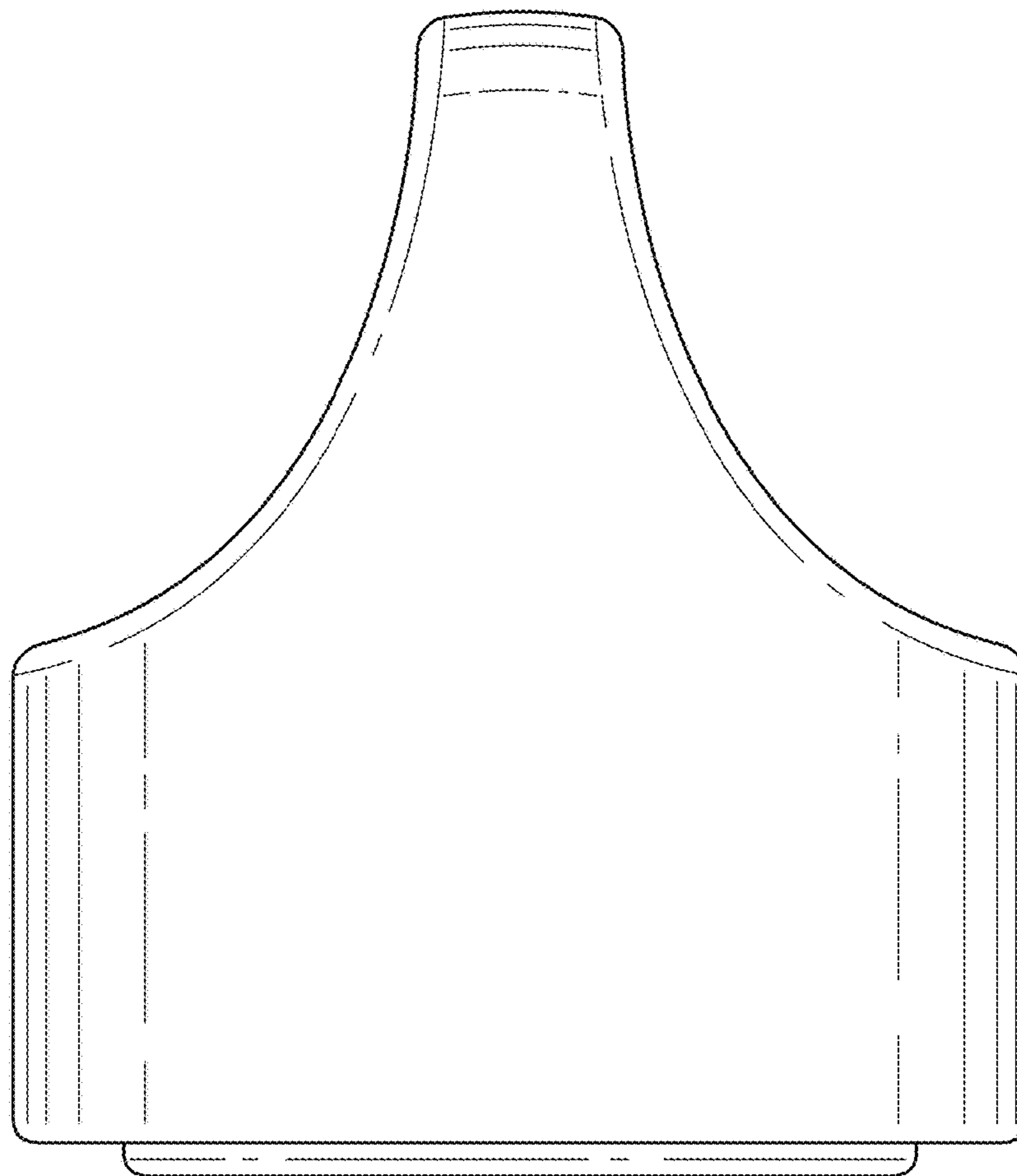

FIG. 14

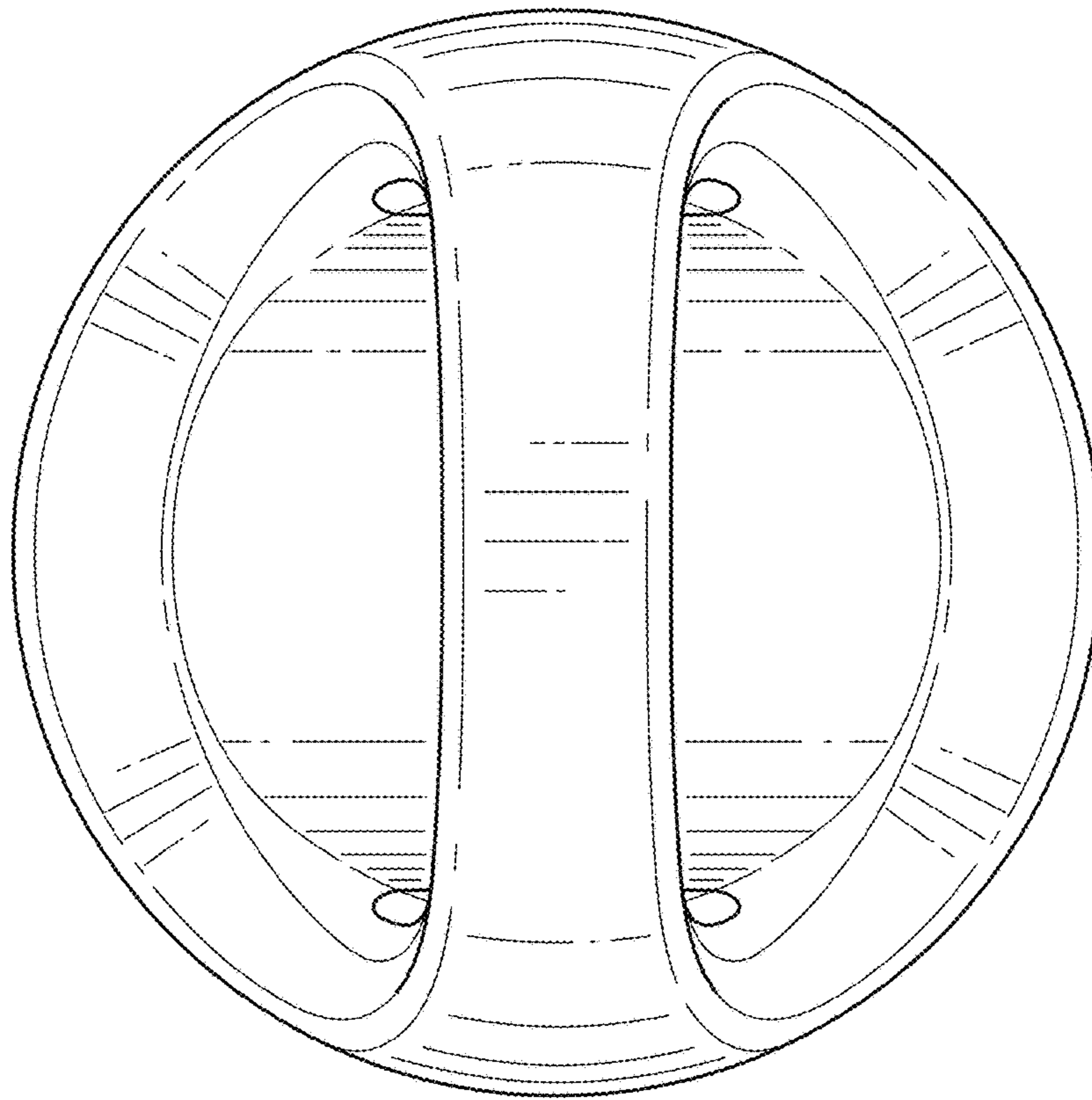

FIG. 15

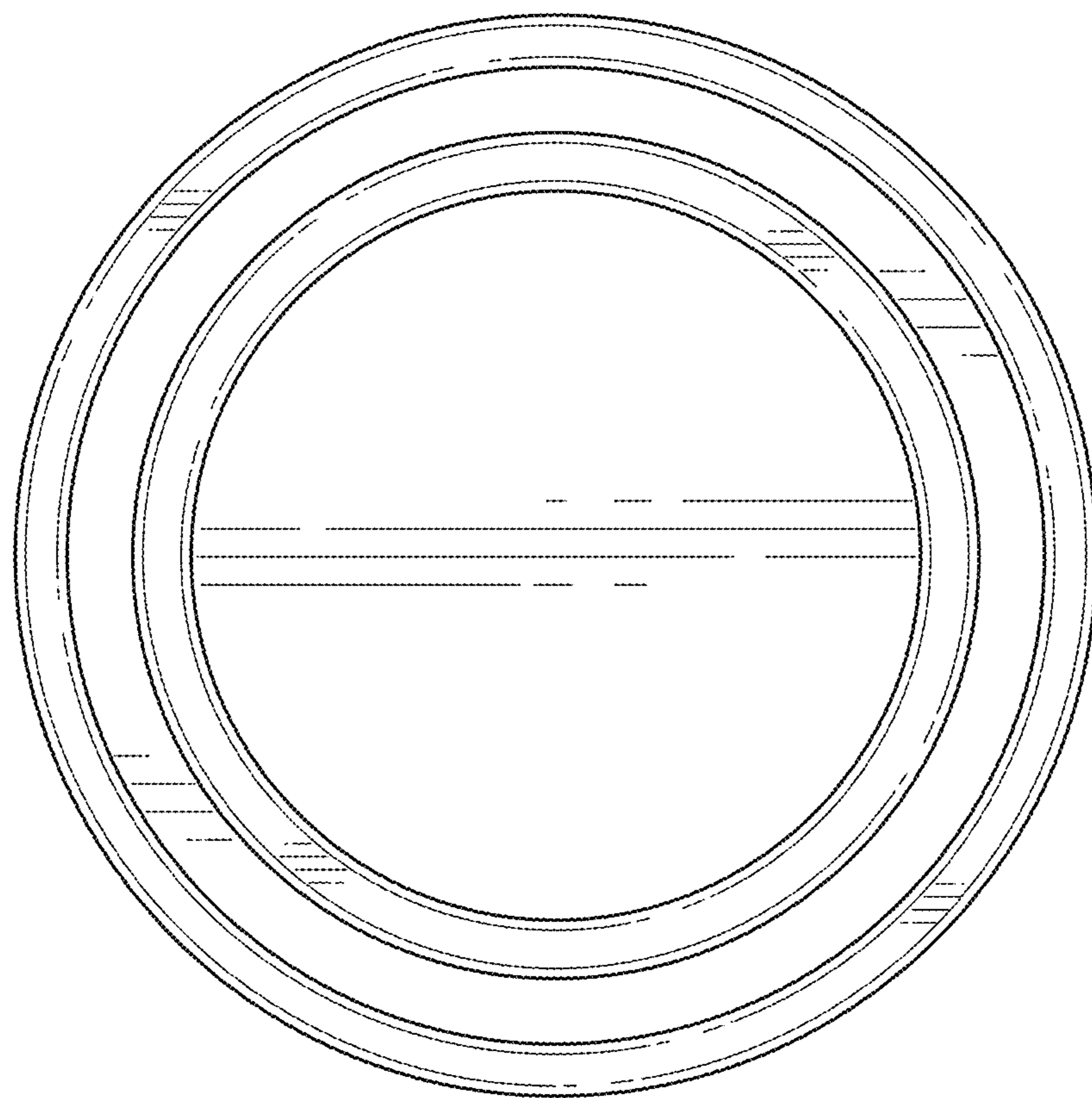

FIG. 16