



US00D796257S

(12) **United States Design Patent**  
**Levy**

(10) **Patent No.:** **US D796,257 S**

(45) **Date of Patent:** **\*\* Sep. 5, 2017**

(54) **CARAFE**

(71) Applicant: **SOCIETE JAS HENNESSY & CO.,**  
Cognac (FR)

(72) Inventor: **Arik Levy**, Paris (FR)

(73) Assignee: **SOCIETE JAS HENNESSY & CO.,**  
Cognac (FR)

(\*\*) Term: **15 Years**

(21) Appl. No.: **29/539,976**

(22) Filed: **Sep. 18, 2015**

(30) **Foreign Application Priority Data**

Jun. 24, 2015 (EP) ..... 02725507

(51) **LOC (10) Cl.** ..... **07-01**

(52) **U.S. Cl.**  
USPC ..... **D7/397; D7/300; D7/532; D7/505;**  
D9/434

(58) **Field of Classification Search**

USPC ..... D7/507, 509, 510, 511, 512, 513, 523,  
D7/529, 530, 531, 532, 608, 300, 300.1,  
D7/591, 598, 312, 392.1, 396.2, 398, 505,  
D7/610, 624.1, 317, 318, 305, 213, 397,  
D7/396.1; D9/501, 502, 500, 503, 505,  
D9/516, 523, 530, 537, 546, 550, 552,  
D9/563, 565, 569, 571, 434, 447, 440;  
D3/202; 220/592.16, 592.17, 200, 703;  
D21/390, 389, 392, 393, 426, 403, 404,  
D21/471, 455, 459, 463, 680, 681  
CPC ..... A45F 3/16; B65D 47/066; A47G 19/2272;  
A47G 19/2266; A47J 43/27  
See application file for complete search history.

(56) **References Cited**

**U.S. PATENT DOCUMENTS**

535,535 A \* 3/1895 Gardner ..... A63F 9/20  
273/294  
2,623,633 A \* 12/1952 Bladow ..... A45F 3/46  
108/91

3,690,610 A \* 9/1972 Peirce ..... A21B 3/00  
108/101  
4,311,237 A \* 1/1982 Hayes ..... A47G 23/08  
206/203  
D291,583 S \* 8/1987 Bateman ..... D21/471  
D312,965 S \* 12/1990 Mansau ..... D26/103  
D313,351 S \* 1/1991 Mansau ..... D26/103  
D321,626 S \* 11/1991 Kouts ..... D7/510

(Continued)

*Primary Examiner* — Marianne Pandozzi

*Assistant Examiner* — Jae Liang

(74) *Attorney, Agent, or Firm* — Baker & McKenzie LLP

(57) **CLAIM**

The ornamental design for a carafe, as shown and described.

**DESCRIPTION**

FIG. 1 is a perspective view of a carafe in its first position in use showing my new design;  
FIG. 2 is a front view of a carafe shown in FIG. 1;  
FIG. 3 is a rear view of a carafe shown in FIG. 1;  
FIG. 4 is a first side view of a carafe shown in FIG. 1;  
FIG. 5 is a second side view of a carafe shown in FIG. 1;  
FIG. 6 is a top view of a carafe shown in FIG. 1;  
FIG. 7 is a bottom view of a carafe shown in FIG. 1;  
FIG. 8 is a perspective view of a carafe in its second position in use;  
FIG. 9 is a front view of a carafe shown in FIG. 8;  
FIG. 10 is a rear view of a carafe shown in FIG. 8;  
FIG. 11 is a first side view of a carafe shown in FIG. 8;  
FIG. 12 is a second side view of a carafe shown in FIG. 8;  
FIG. 13 is a top view of a carafe shown in FIG. 8; and,  
FIG. 14 is a bottom view of a carafe shown in FIG. 8.  
The broken lines in the drawing depict portions of the carafe that form no part of the claimed design.

**1 Claim, 14 Drawing Sheets**

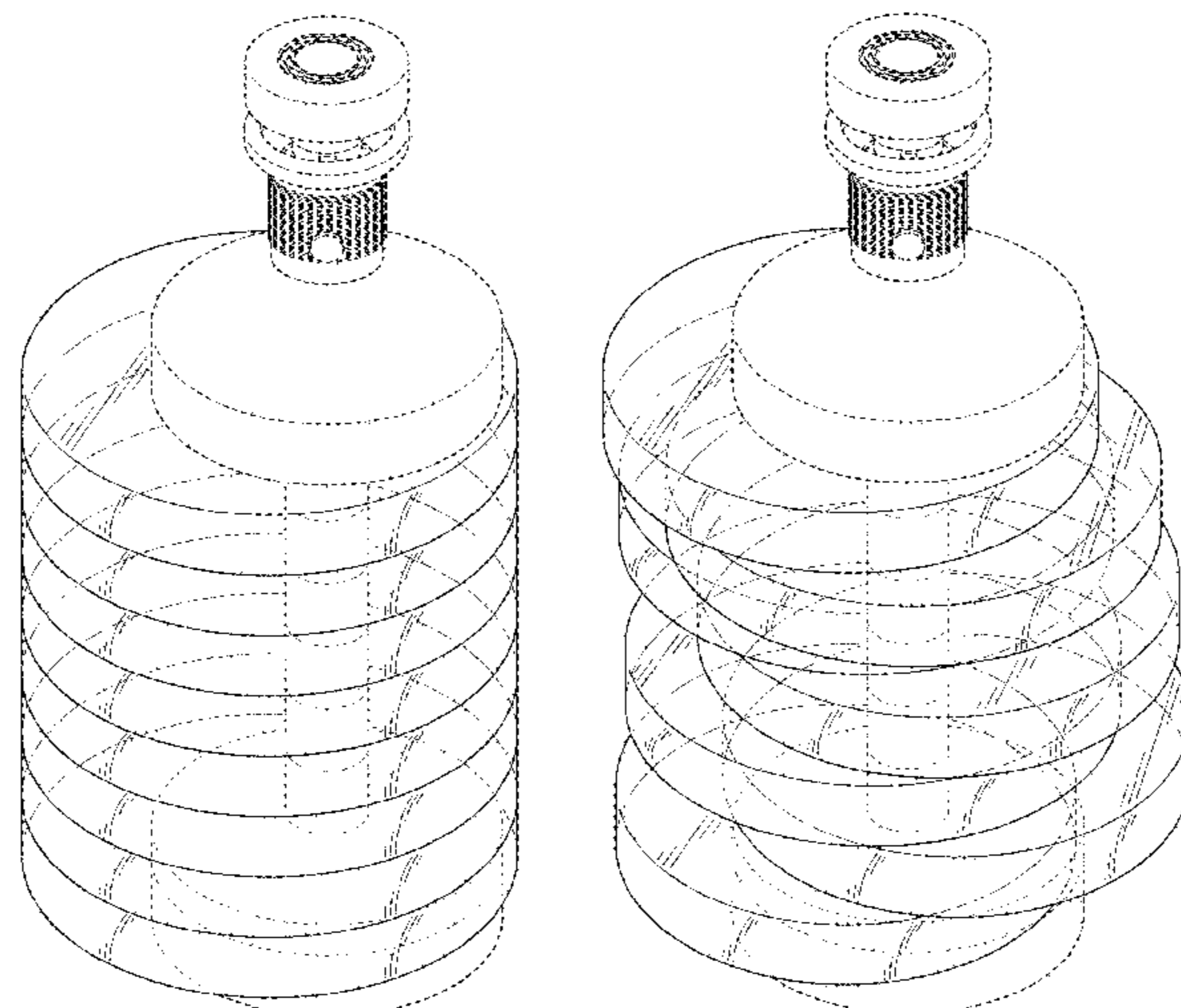

(56)

**References Cited**

U.S. PATENT DOCUMENTS

D329,169	S *	9/1992	Robbins, III	.....	D7/300
D329,548	S *	9/1992	Wells	.....	D6/407
5,300,001	A *	4/1994	Sealy	.....	A63B 21/0602
					128/DIG. 15
5,400,907	A *	3/1995	Chen	.....	A47G 19/2227
					206/459.1
5,407,413	A *	4/1995	Kupferman	.....	A63B 21/0728
					482/106
D359,196	S *	6/1995	Nichols	.....	D7/511
D397,932	S *	9/1998	Mazda	.....	D9/683
D413,046	S *	8/1999	Fritze	.....	D7/505
D499,023	S *	11/2004	Amos	.....	D10/101
D499,968	S *	12/2004	Lam	.....	D10/15
D574,188	S *	8/2008	Beny	.....	D7/500
D609,526	S *	2/2010	Tuttle	.....	D21/681
D676,277	S *	2/2013	Riedel	.....	D7/396.1
8,556,099	B2 *	10/2013	Perlman	.....	A45F 3/20
					206/217
D695,128	S *	12/2013	Ozsinmaz	.....	D21/681
D696,953	S *	1/2014	Kanda	.....	D9/516
D706,134	S *	6/2014	Sory	.....	D9/435
D746,168	S *	12/2015	Vaughan	.....	D11/81
2008/0185781	A1 *	8/2008	Mascolo	.....	A63F 9/0073
					273/153 P

\* cited by examiner

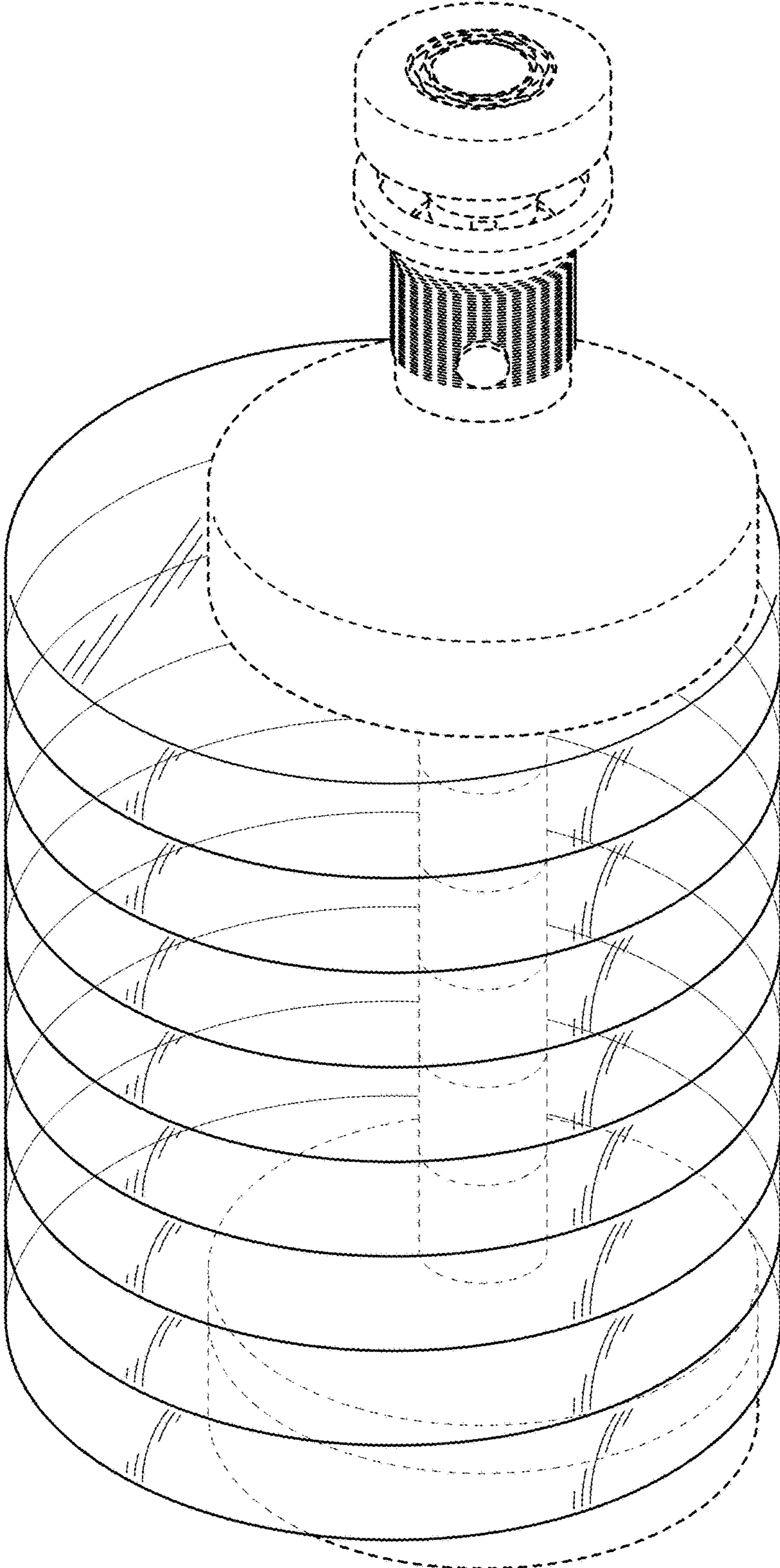

FIG. 1

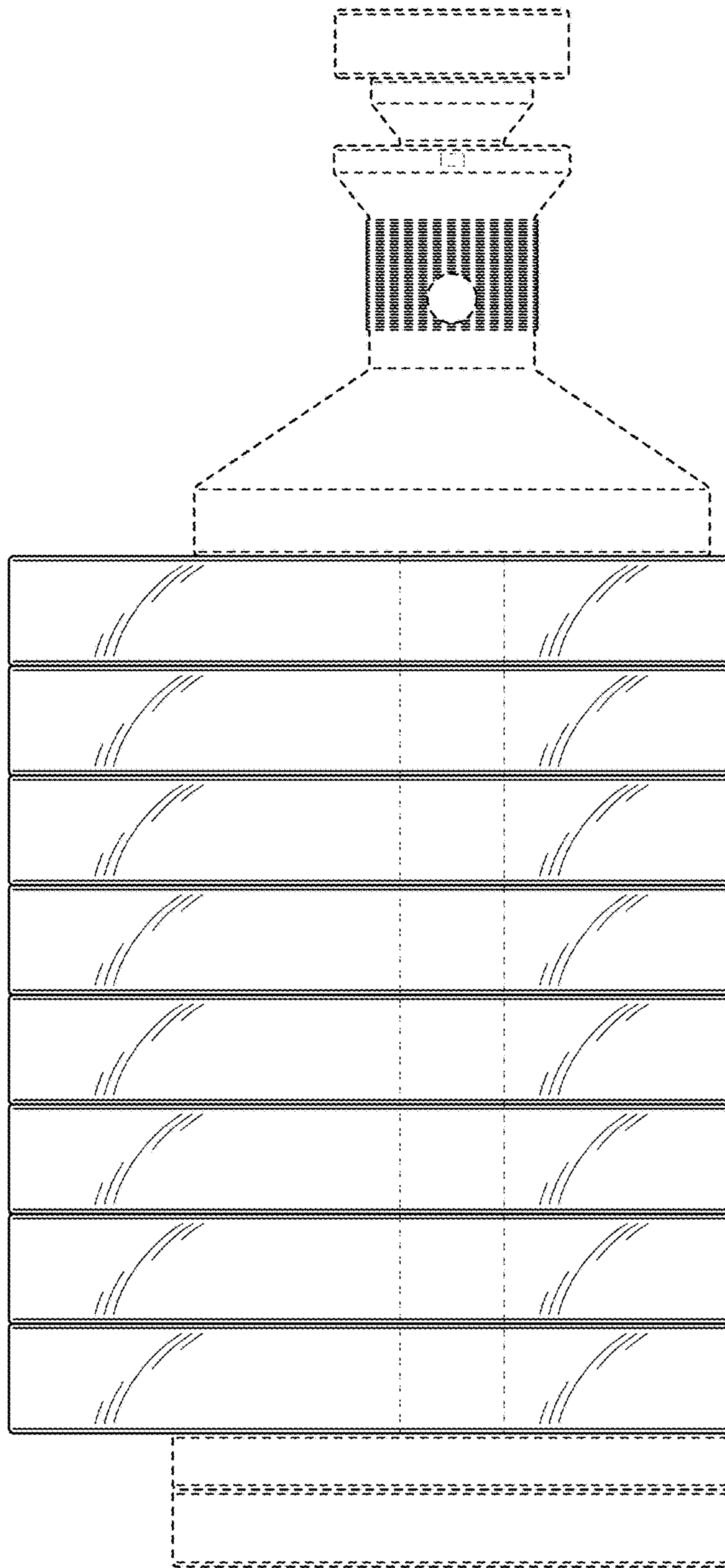

FIG. 2

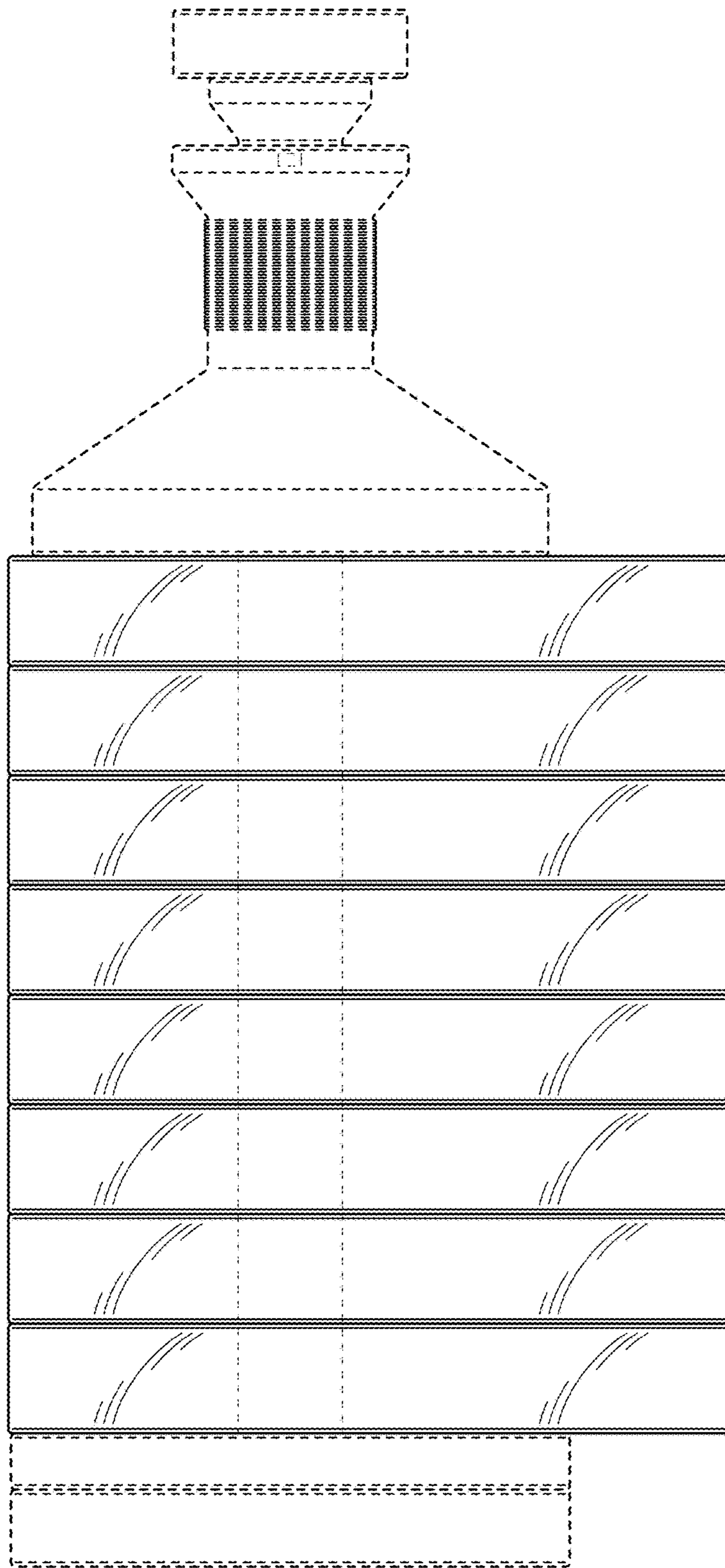

FIG. 3

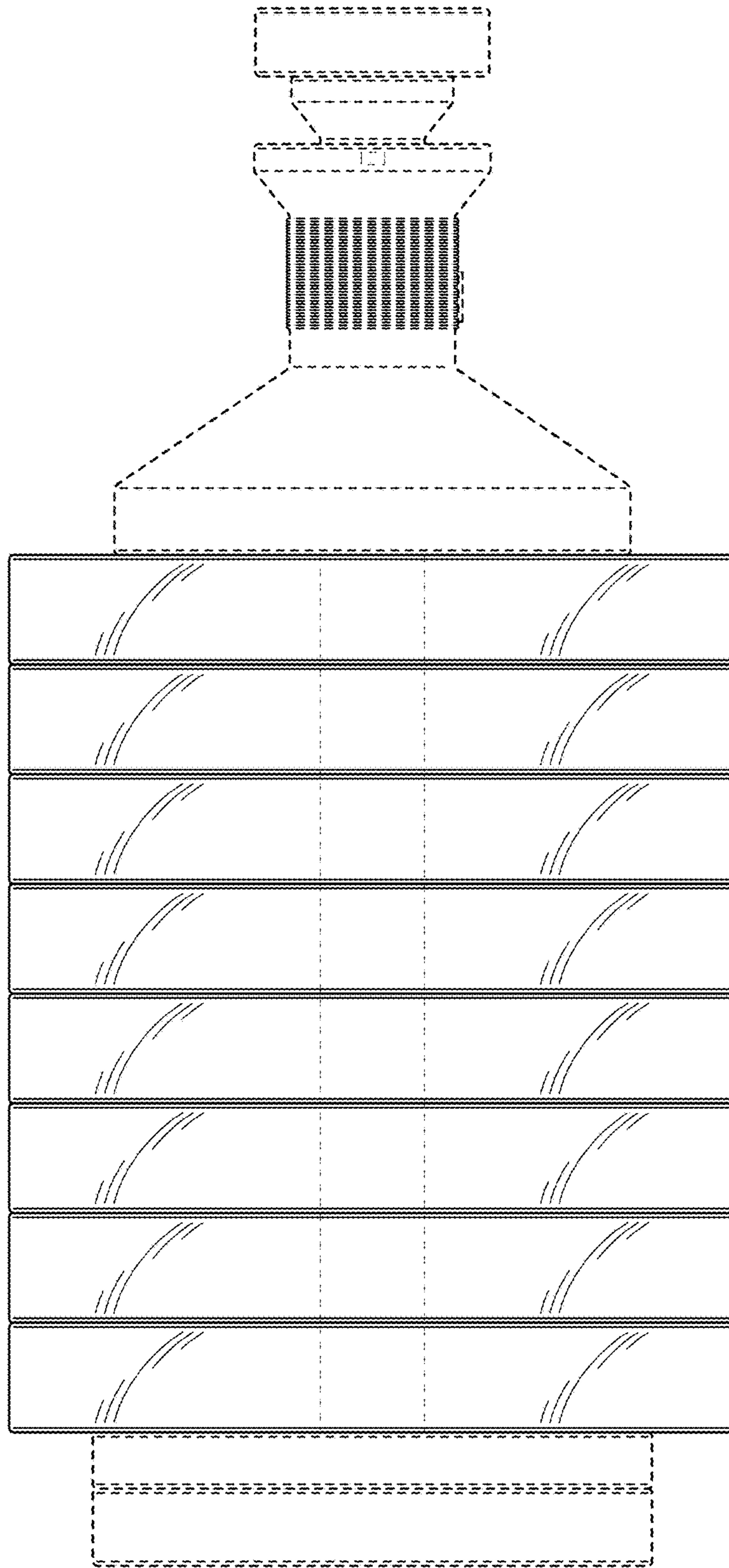

FIG. 4

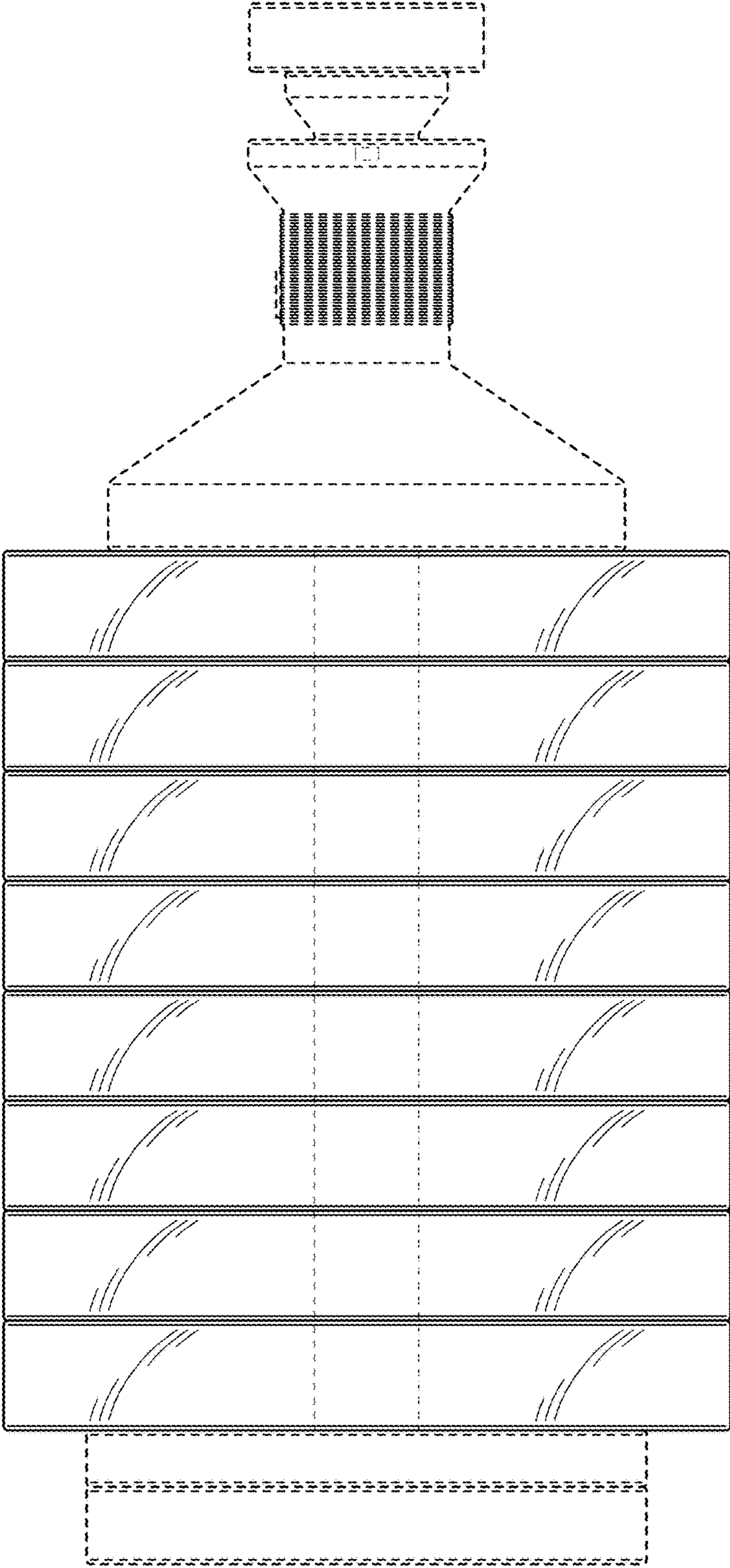

FIG. 5

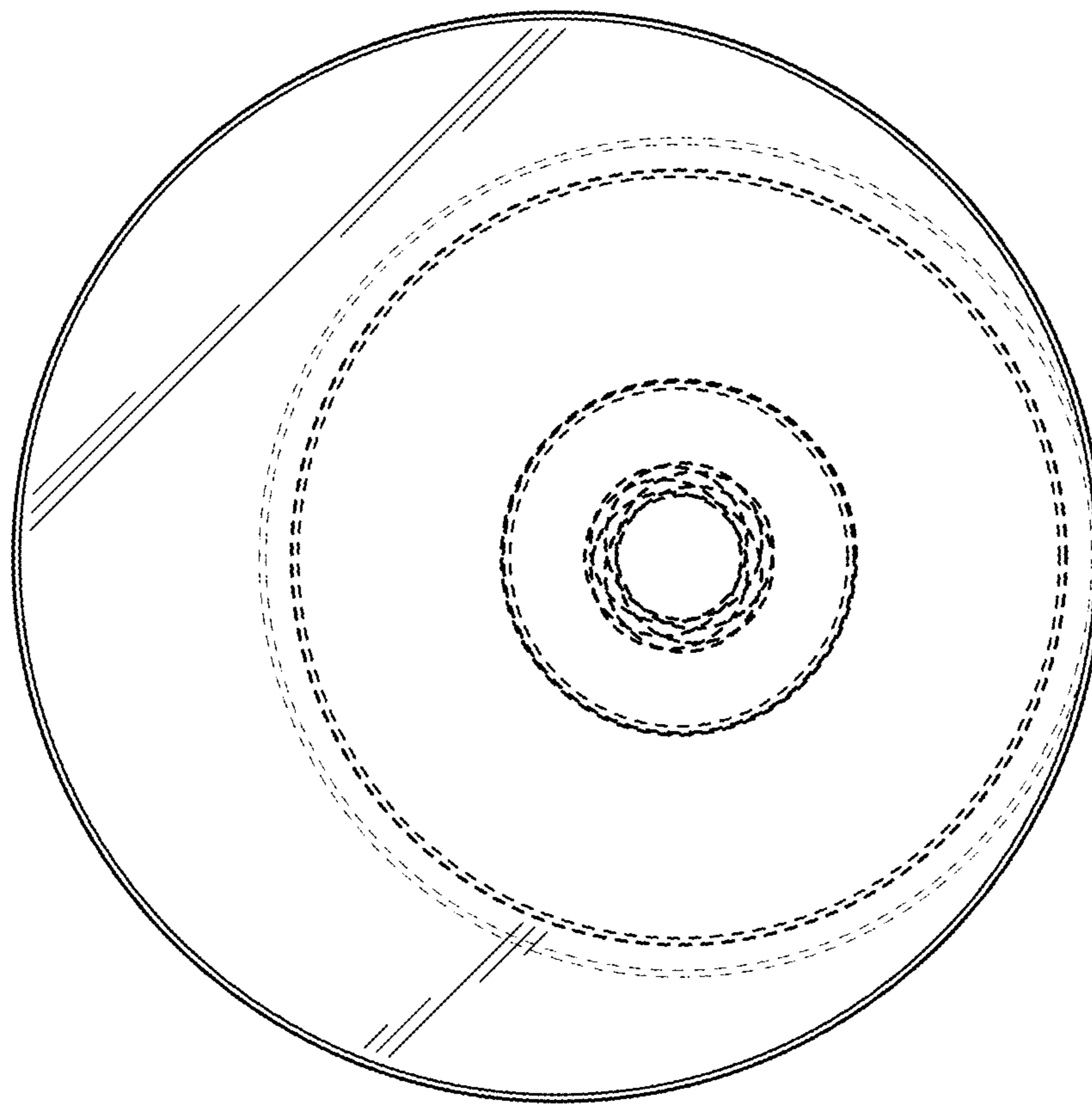

FIG. 6



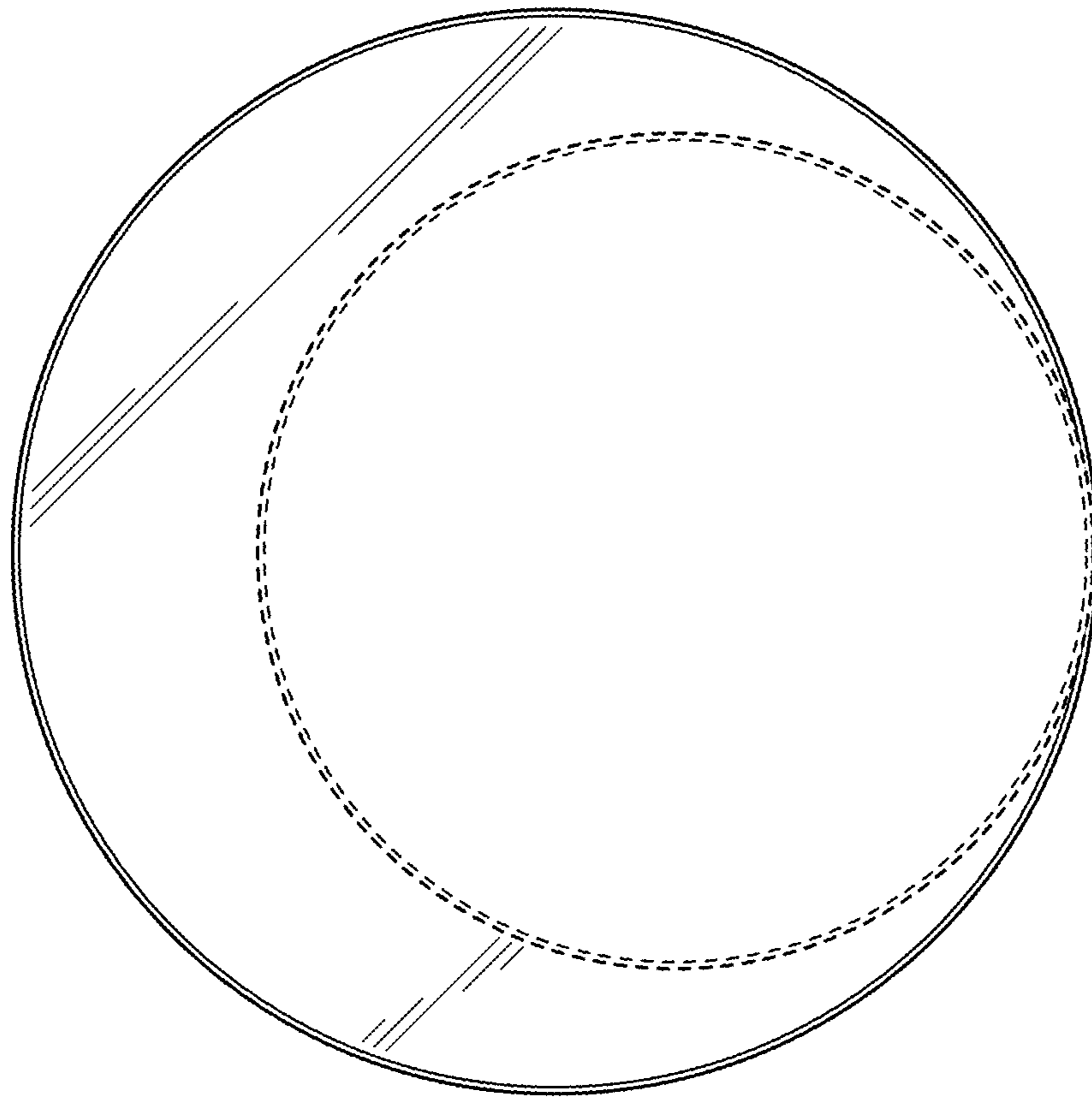

FIG. 7

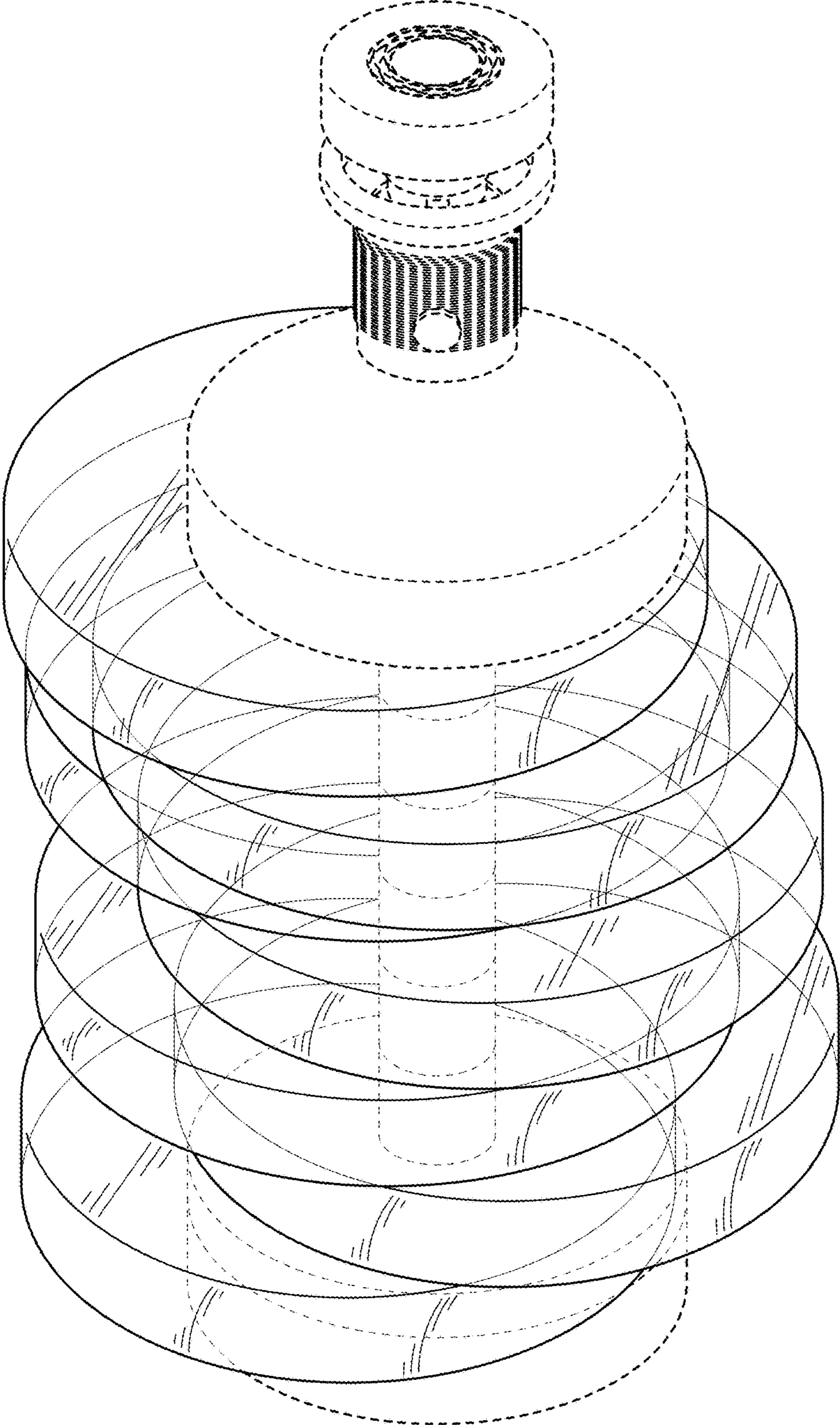

FIG. 8

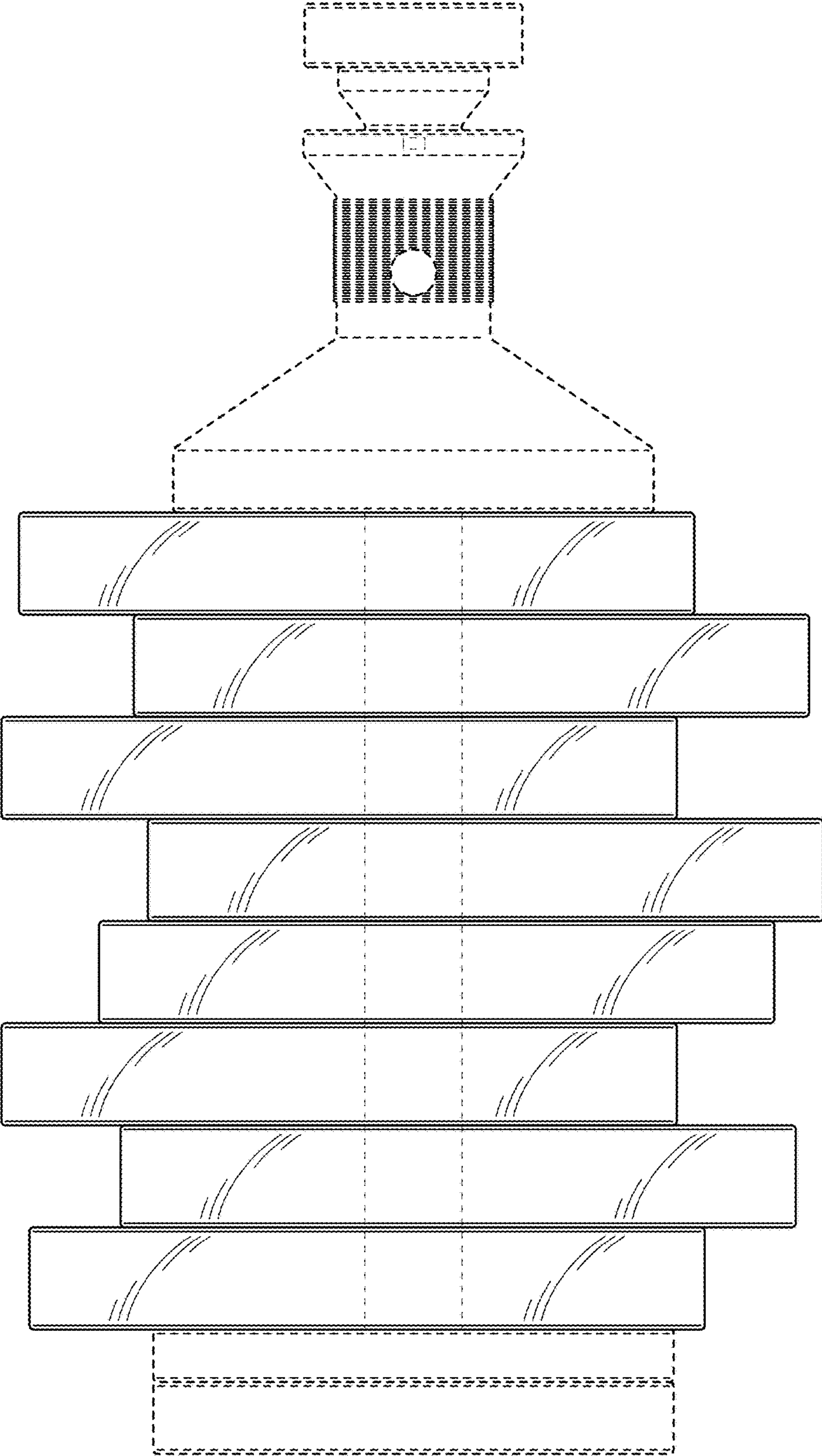

FIG. 9

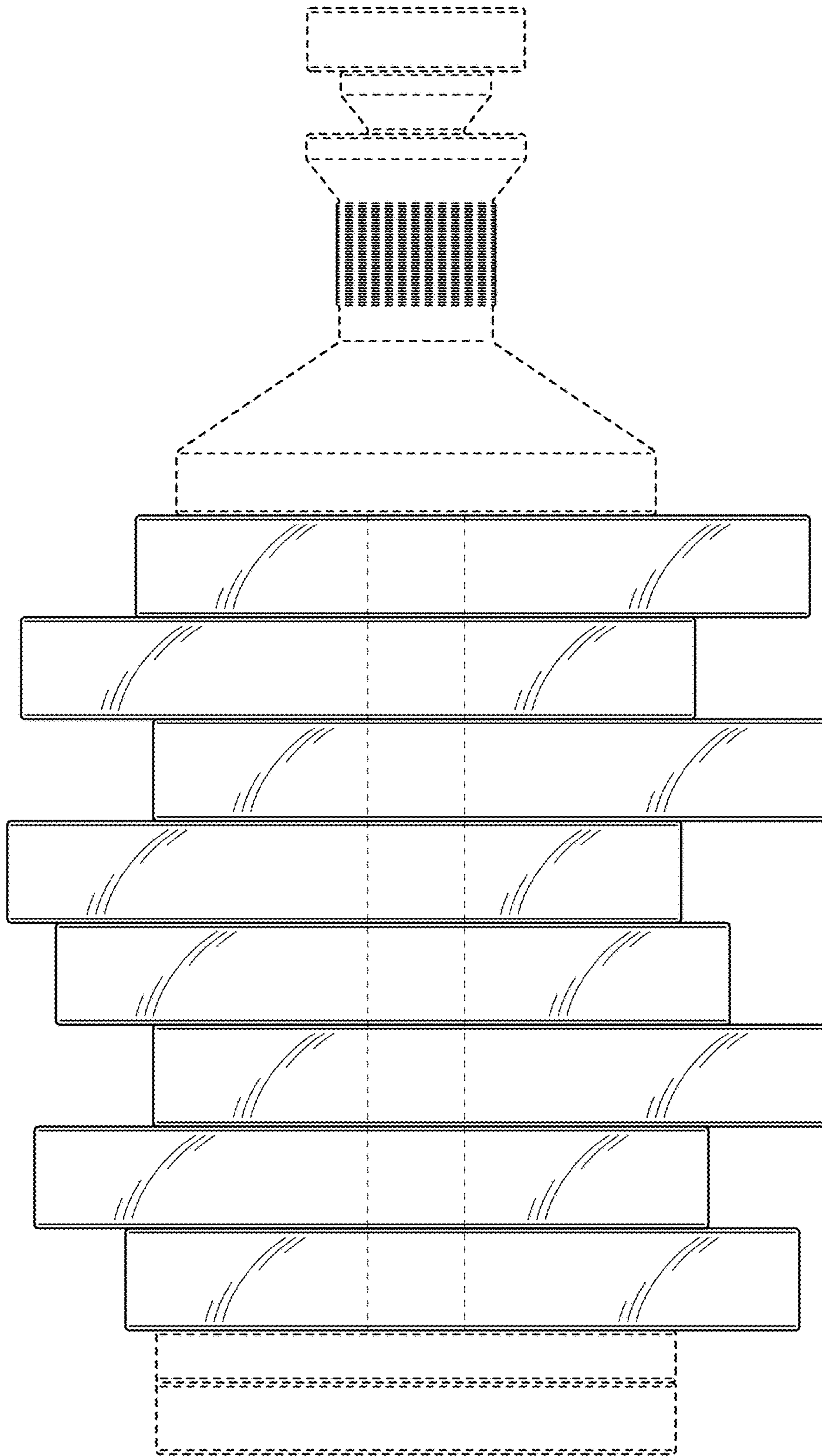

FIG. 10

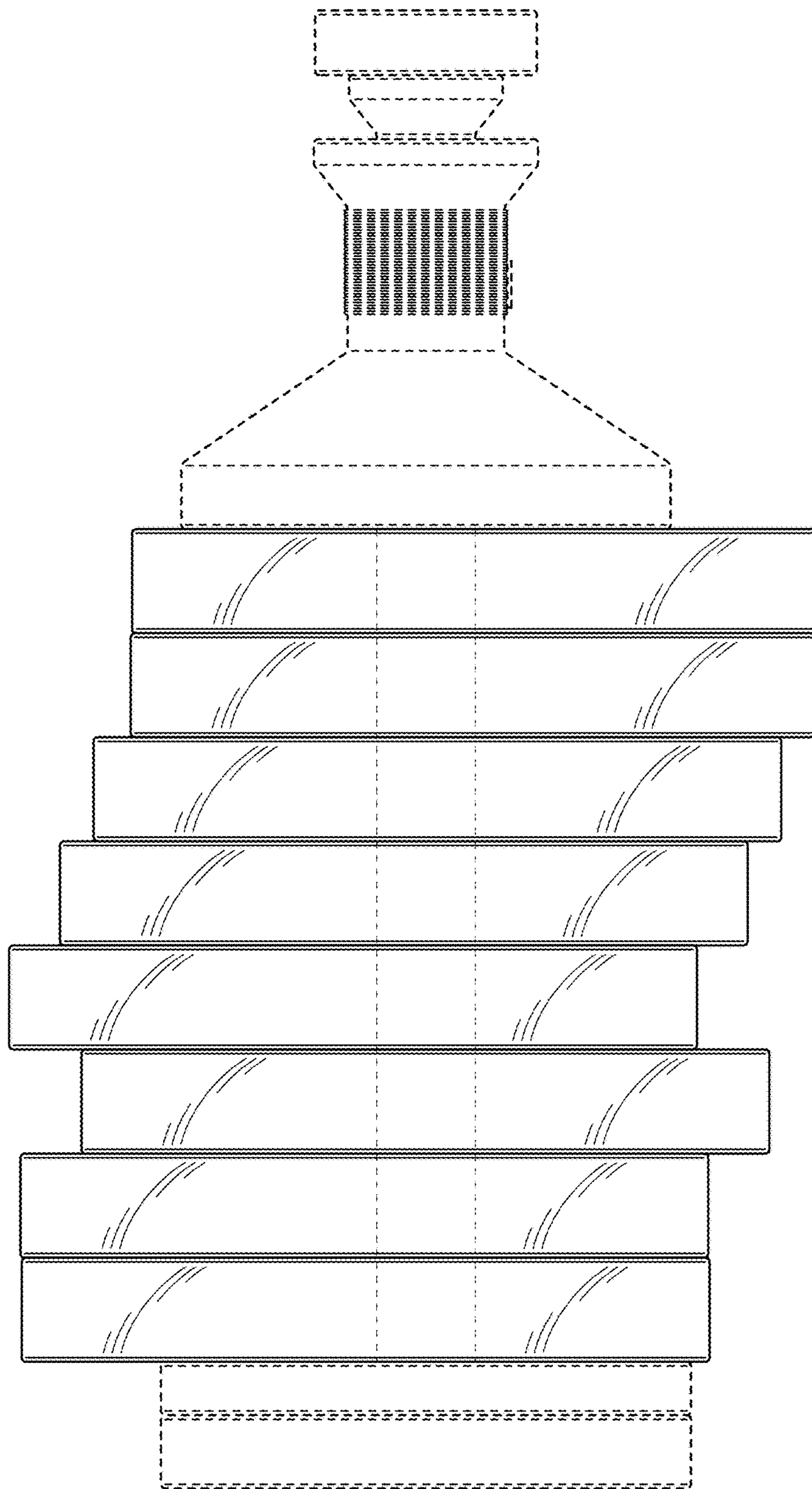

FIG. 11

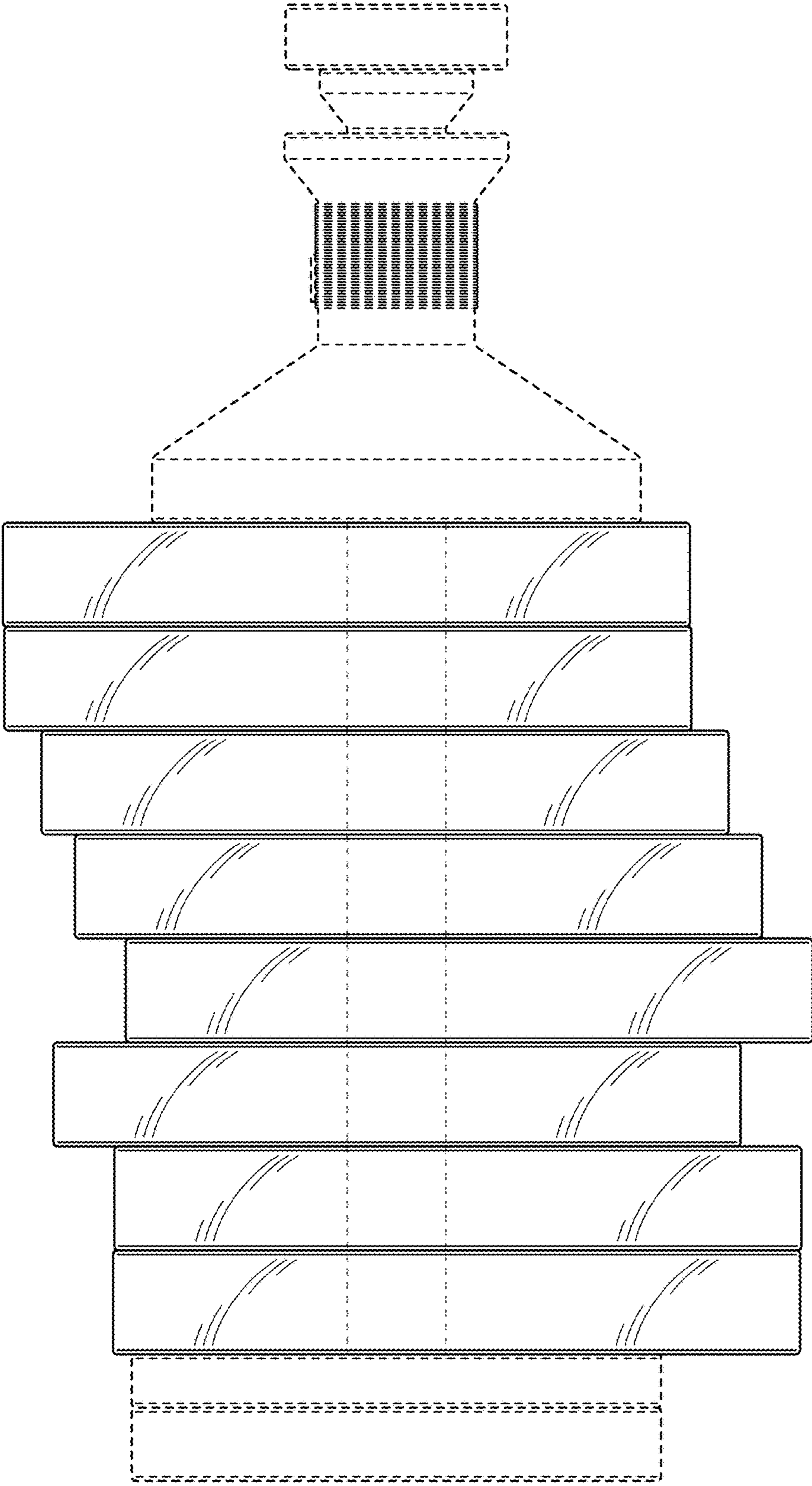

FIG. 12

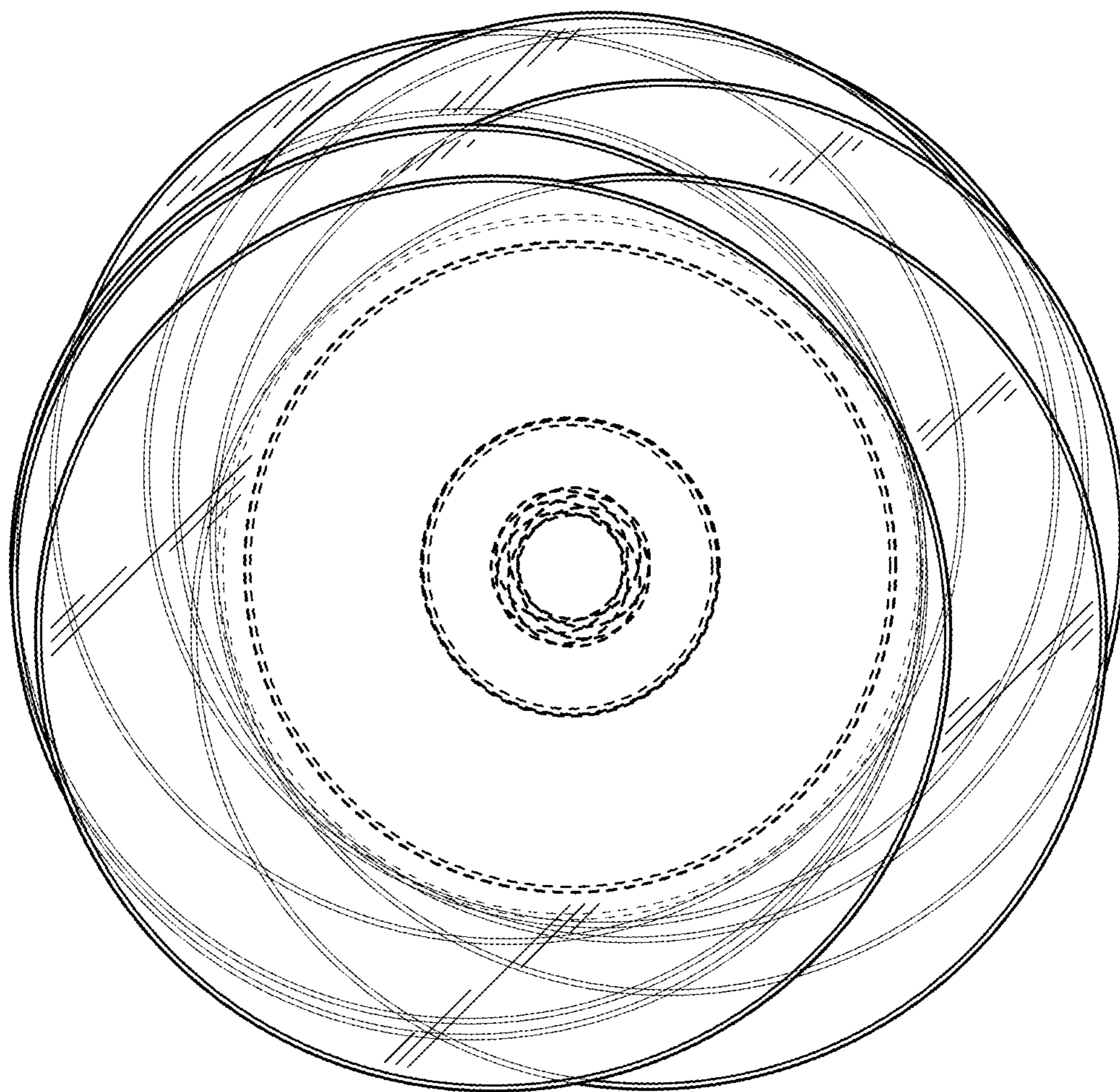

FIG. 13

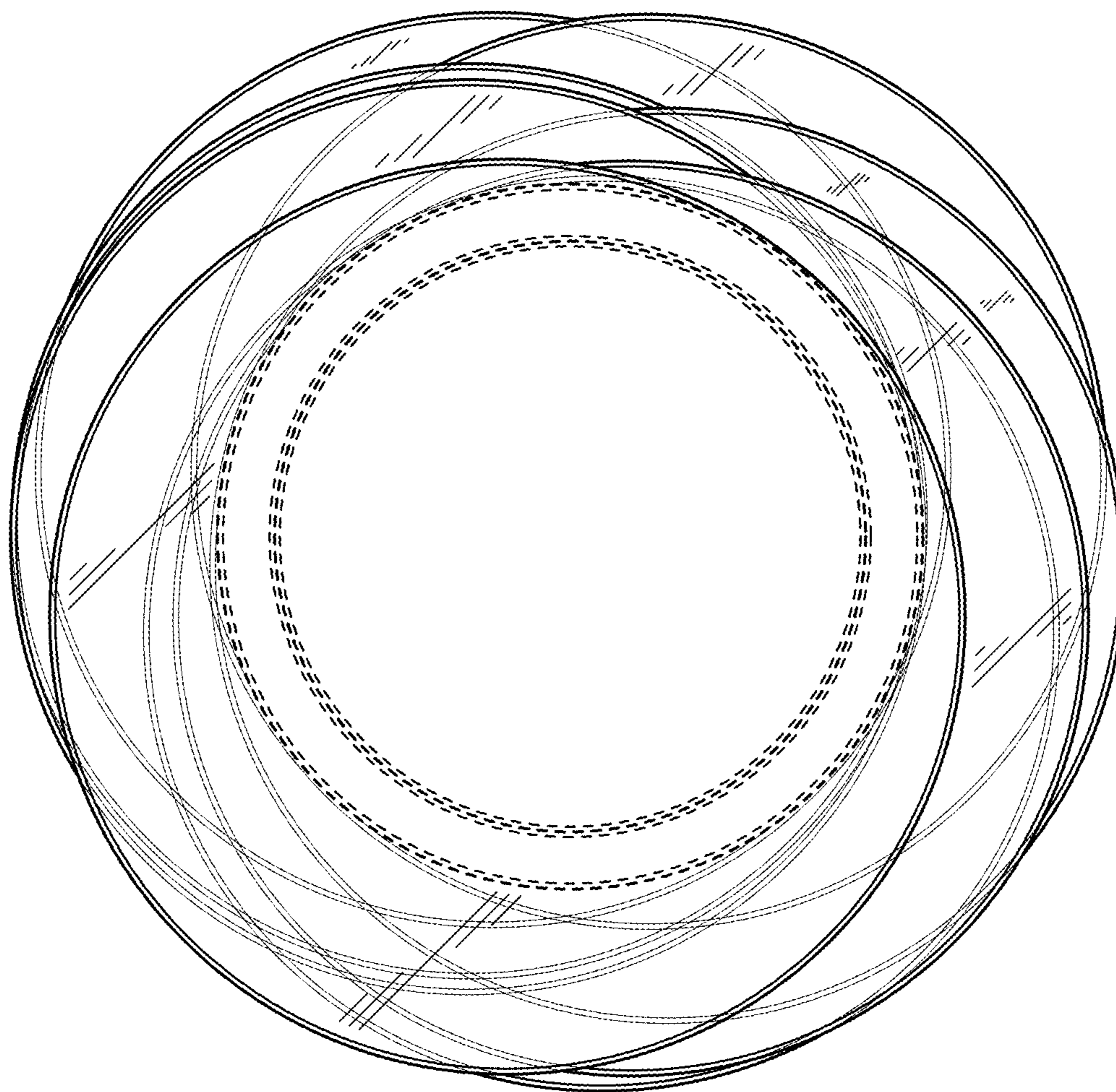

FIG. 14