



US00D796114S

(12) **United States Design Patent** (10) **Patent No.:** **US D796,114 S**  
**Nicoline** (45) **Date of Patent:** **\*\* Aug. 29, 2017**

(54) **COSMETICS APPLICATOR**  
(71) Applicant: **Paris Presents Incorporated**, Gurnee, IL (US)  
(72) Inventor: **Alyssa Nicoline**, McHenry, IL (US)  
(73) Assignee: **Paris Presents Incorporated**, Gurnee, IL (US)  
(\*\*) Term: **15 Years**  
(21) Appl. No.: **29/555,059**  
(22) Filed: **Feb. 18, 2016**  
(51) **LOC (10) Cl.** ..... **28-02**  
(52) **U.S. Cl.**  
USPC ..... **D28/7**  
(58) **Field of Classification Search**  
USPC ..... D28/7, 8, 59, 82; D4/137; D8/300, 307, D8/310, 378, 380, 352; D9/724-725; D21/455, 460, 463; D26/154; D1/118, D1/130; D19/187, 199, 203; D32/40, D32/119  
CPC ..... A47K 7/03; A61M 35/003; A45D 40/00; A45D 2200/1009; A45D 2200/1018; A45D 2200/1036; A47L 13/17; A46B 9/021  
See application file for complete search history.

D758,008 S \* 5/2016 Kolby ..... D28/7  
D768,239 S \* 10/2016 Shen ..... D19/187  
D775,416 S \* 12/2016 Celia, Jr. .... D28/7  
2015/0096919 A1\* 4/2015 Thompson ..... A45D 40/00  
206/525

**OTHER PUBLICATIONS**

“Real techniques miracle complexion sponge,” [online], posted Oct. 14, 2013, retrieved Jan. 30, 2017, retrieved from [http://www.ulta.com/miraclecomplexionsponge?productId=xlslmpprod5960824&sku=2265607&cmpid=PS\\_Non!google!Product\\_Listing\\_Ads&cagpspn=pla&CATCI=pla195003316830&CAAGID=36219145586&CAWELAID=330000200000039656&catargetid=330000200](http://www.ulta.com/miraclecomplexionsponge?productId=xlslmpprod5960824&sku=2265607&cmpid=PS_Non!google!Product_Listing_Ads&cagpspn=pla&CATCI=pla195003316830&CAAGID=36219145586&CAWELAID=330000200000039656&catargetid=330000200).  
“Real techniques miracle mini eraser sponges,” [online], posted Sep. 3, 2016, retrieved Jan. 30, 2017, retrieved from <http://www.ulta.com/miracle-mini-eraser-sponges?productId=xlslmpprod14781001#pr-header-back-to-top-link>.

\* cited by examiner

*Primary Examiner* — Karen Kearney  
*Assistant Examiner* — Debra Callahan  
(74) *Attorney, Agent, or Firm* — The Ollila Law Group LLC

(57) **CLAIM**  
The ornamental design for a cosmetics applicator, substantially as shown and described.

**DESCRIPTION**

FIG. 1 is a perspective view of a cosmetics applicator showing my new design;  
FIG. 2 is a front elevation view thereof;  
FIG. 3 is a rear elevation view thereof;  
FIG. 4 is a left side elevation view thereof;  
FIG. 5 is a right side elevation view thereof;  
FIG. 6 is a top plan view thereof; and,  
FIG. 7 is a bottom plan view thereof.

**1 Claim, 4 Drawing Sheets**

(56) **References Cited**  
U.S. PATENT DOCUMENTS  
D90,699 S \* 9/1933 Columbia ..... D21/460  
D162,124 S \* 2/1951 Brooks ..... D26/89  
D295,911 S \* 5/1988 Zogg ..... D32/40  
D296,005 S \* 5/1988 Alkire ..... D24/119  
D638,163 S \* 5/2011 Ninomiya ..... D28/7  
D640,827 S \* 6/2011 Ninomiya ..... D28/7  
D666,357 S \* 8/2012 Albers ..... D28/7  
D711,690 S \* 8/2014 Sutton ..... D7/625  
D718,897 S \* 12/2014 Randolph ..... D26/154

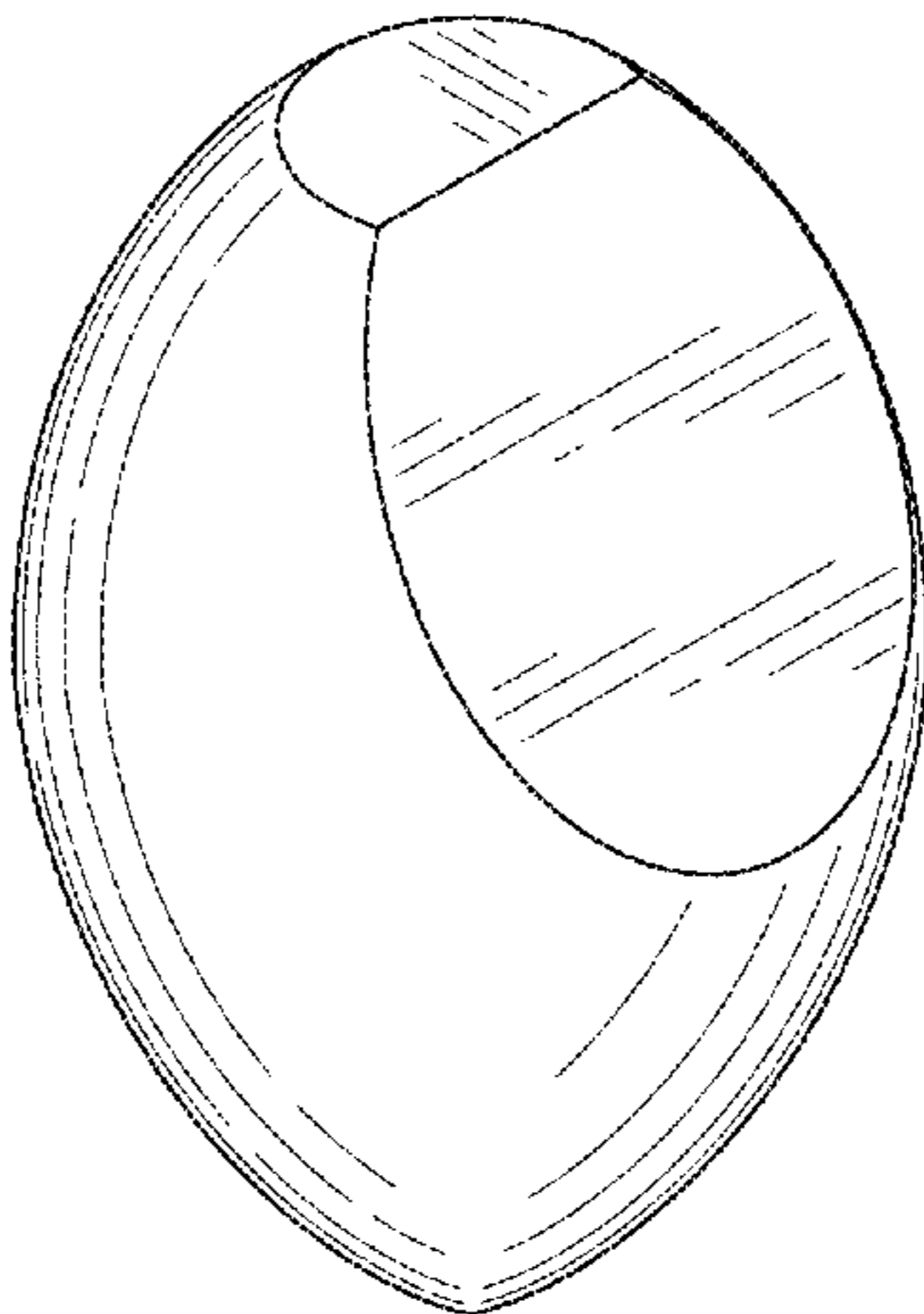

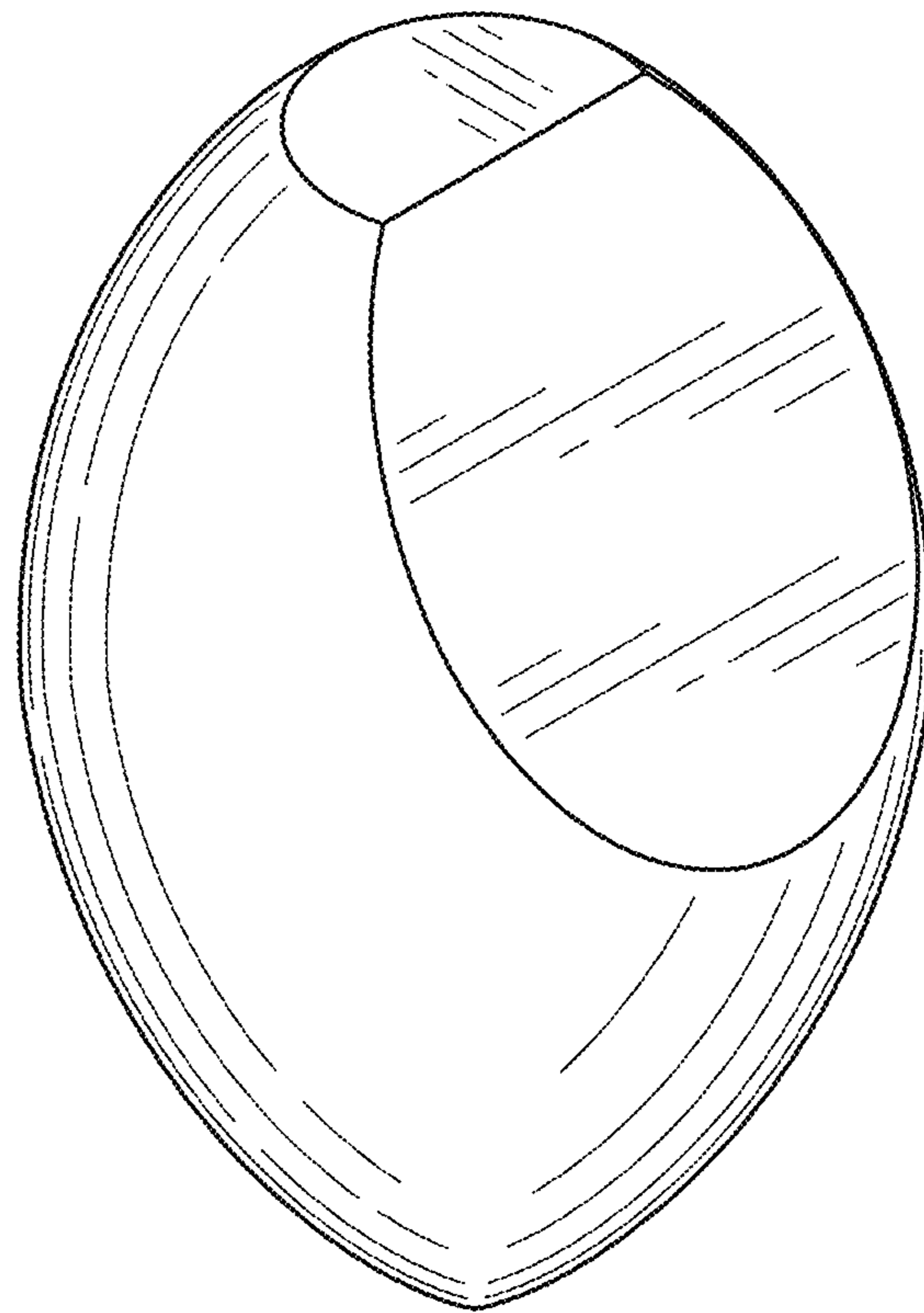

FIG.1

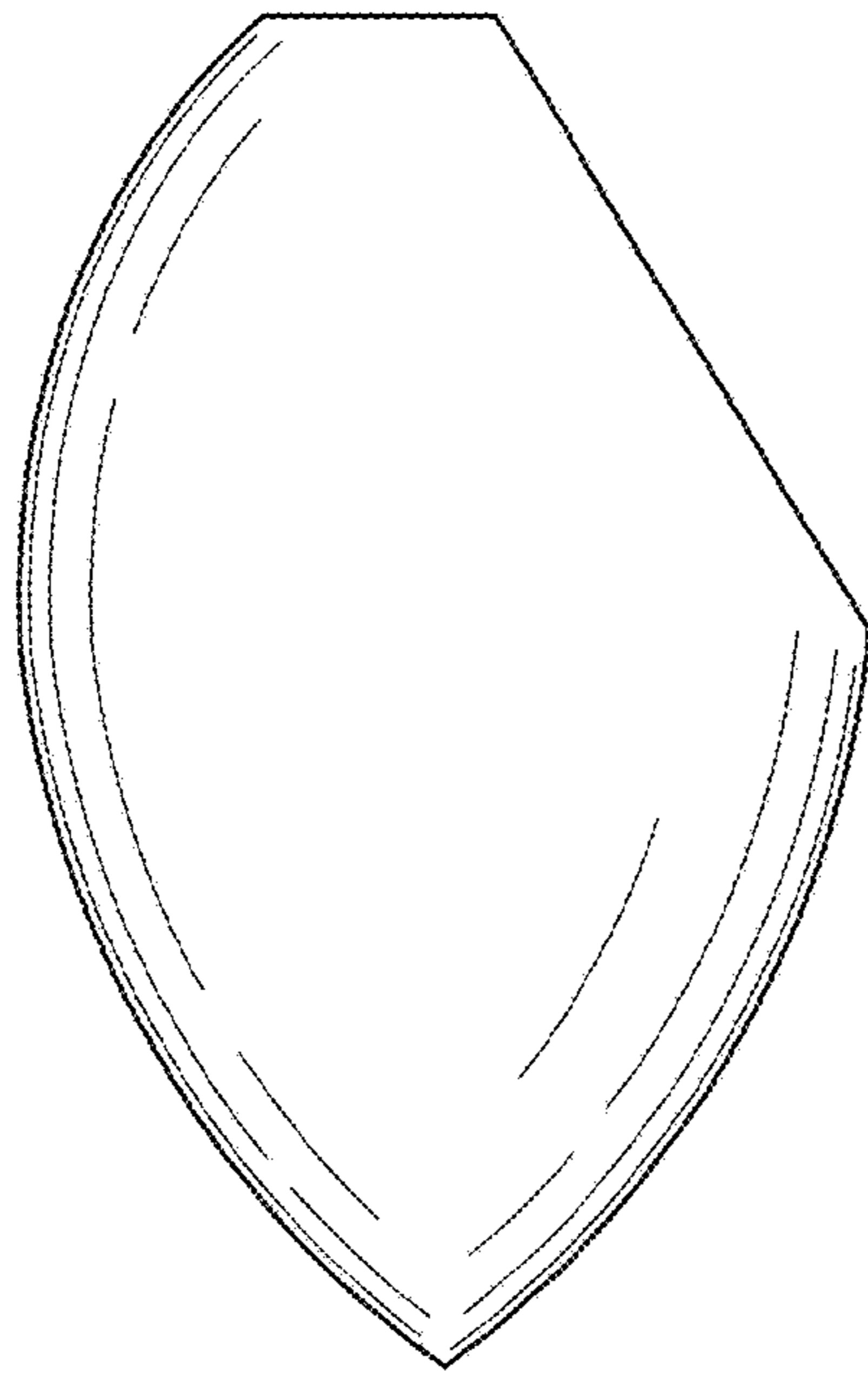

FIG. 2

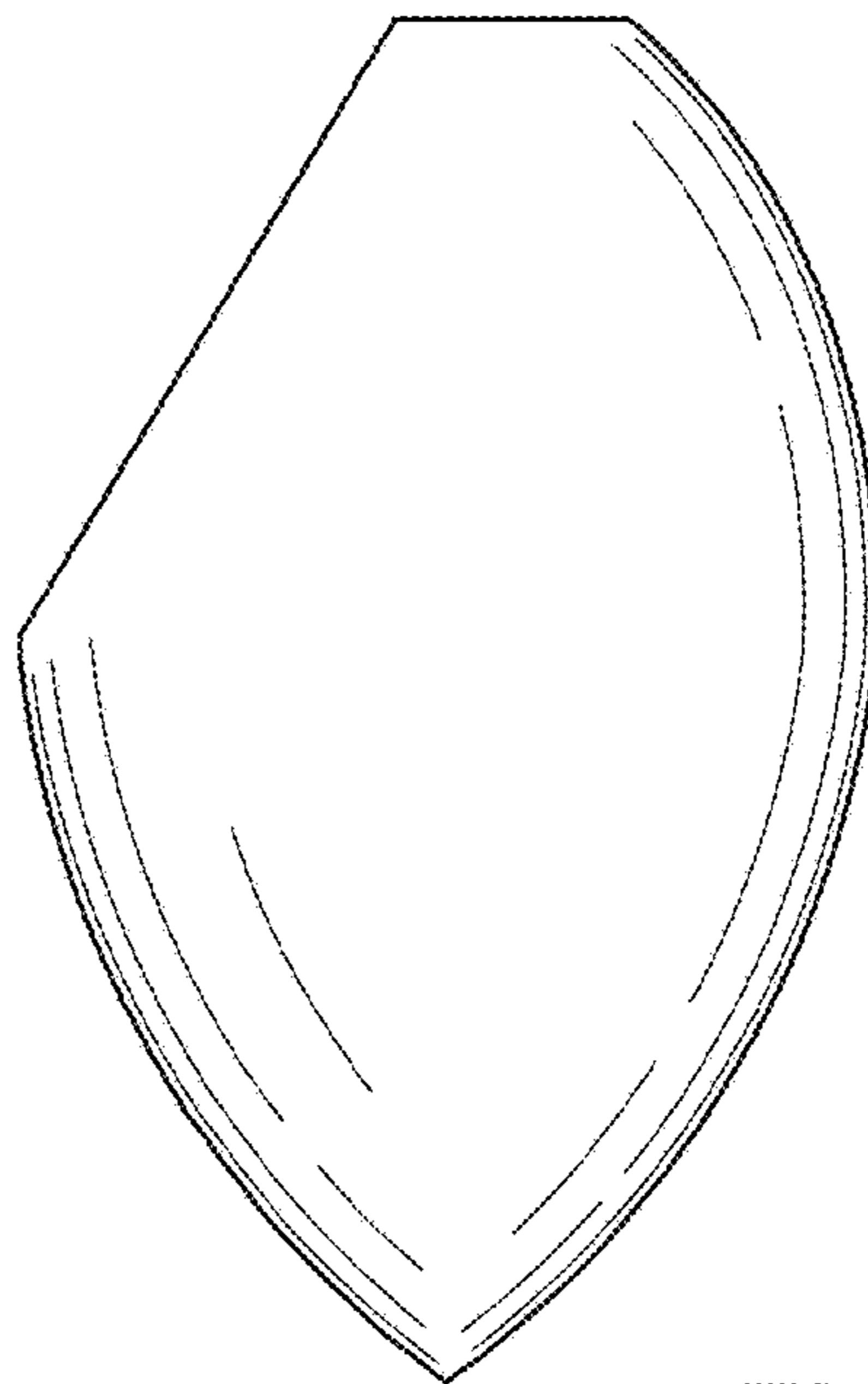

FIG. 3

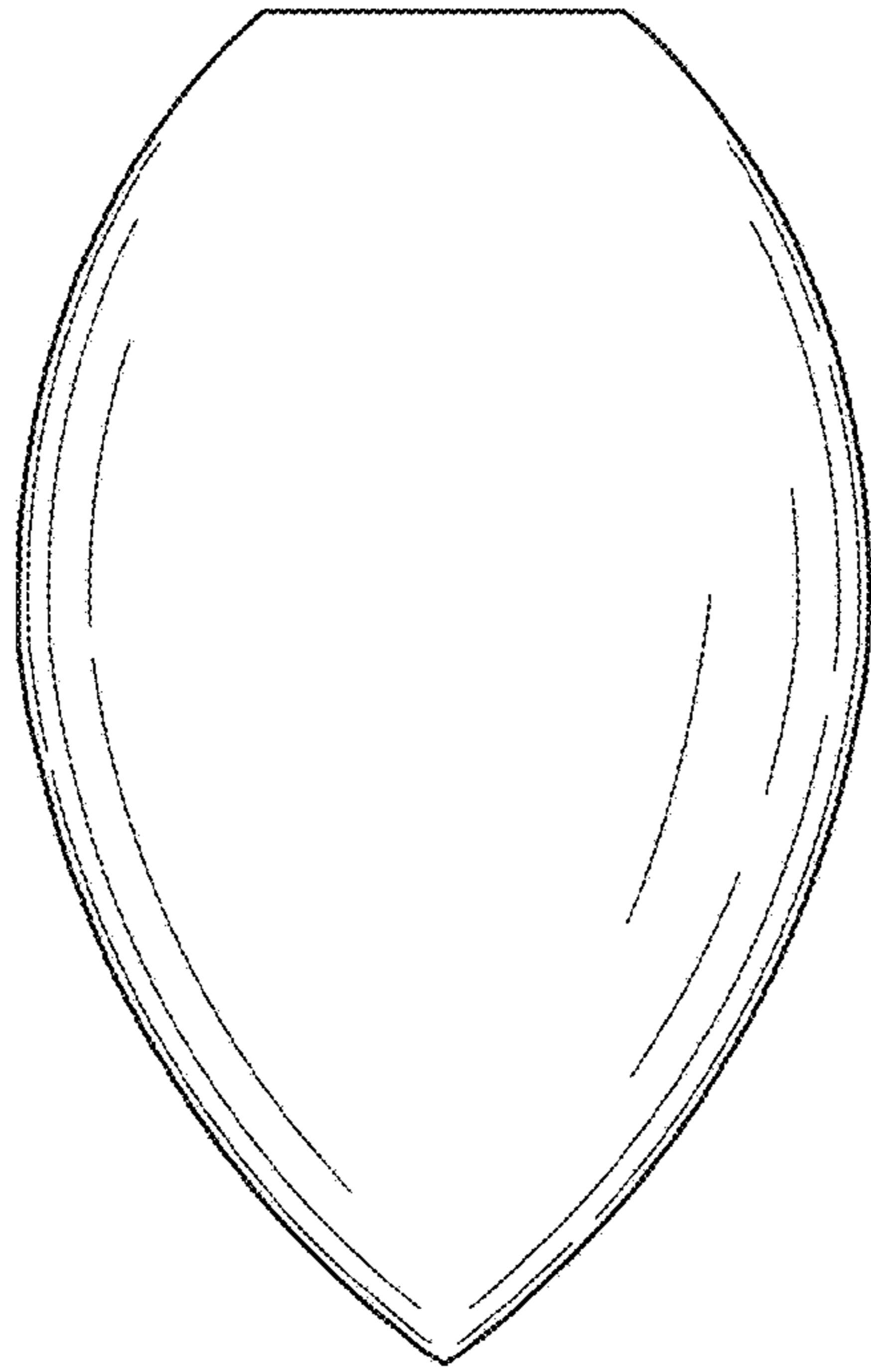

FIG.4

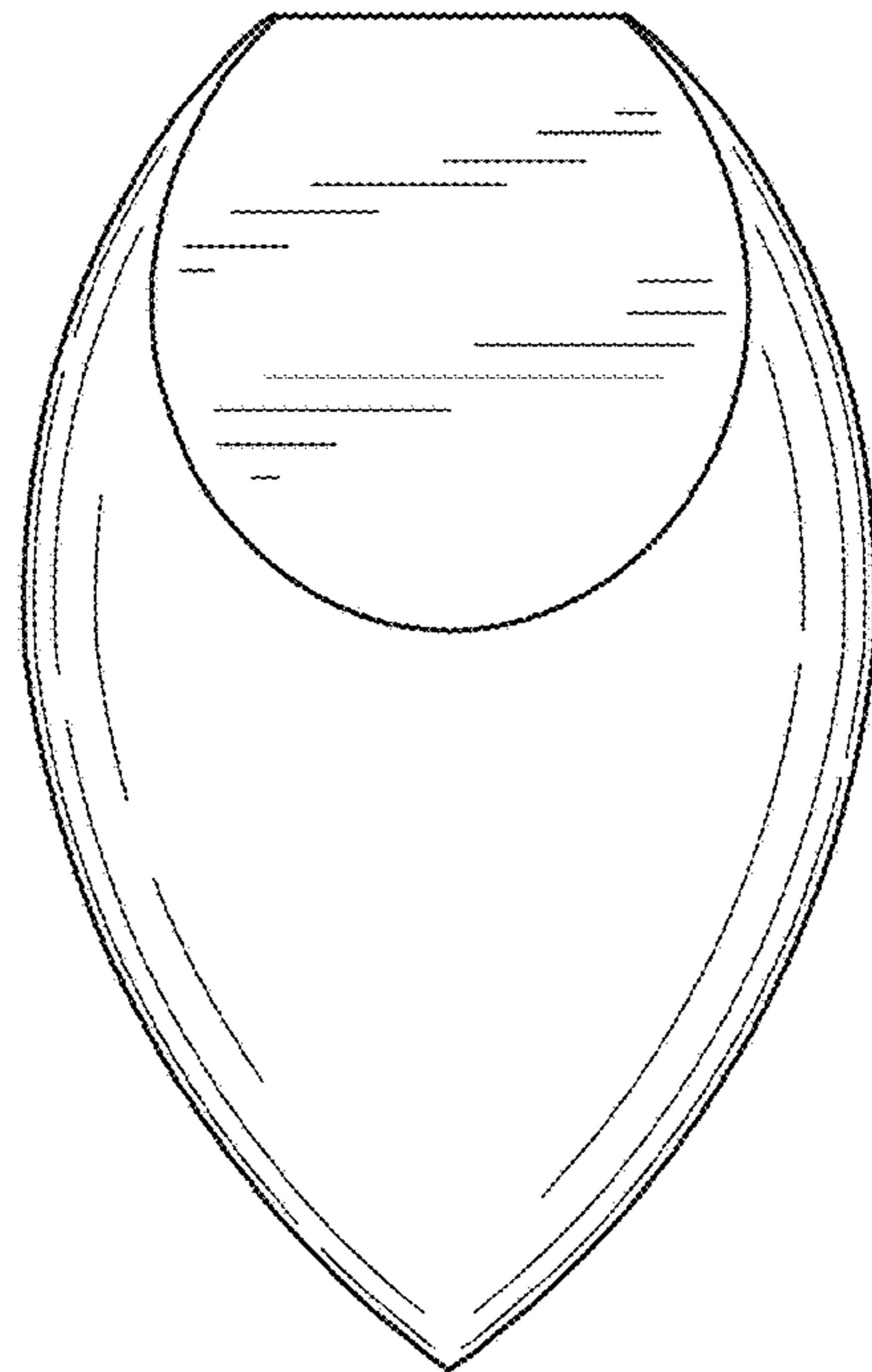

FIG.5

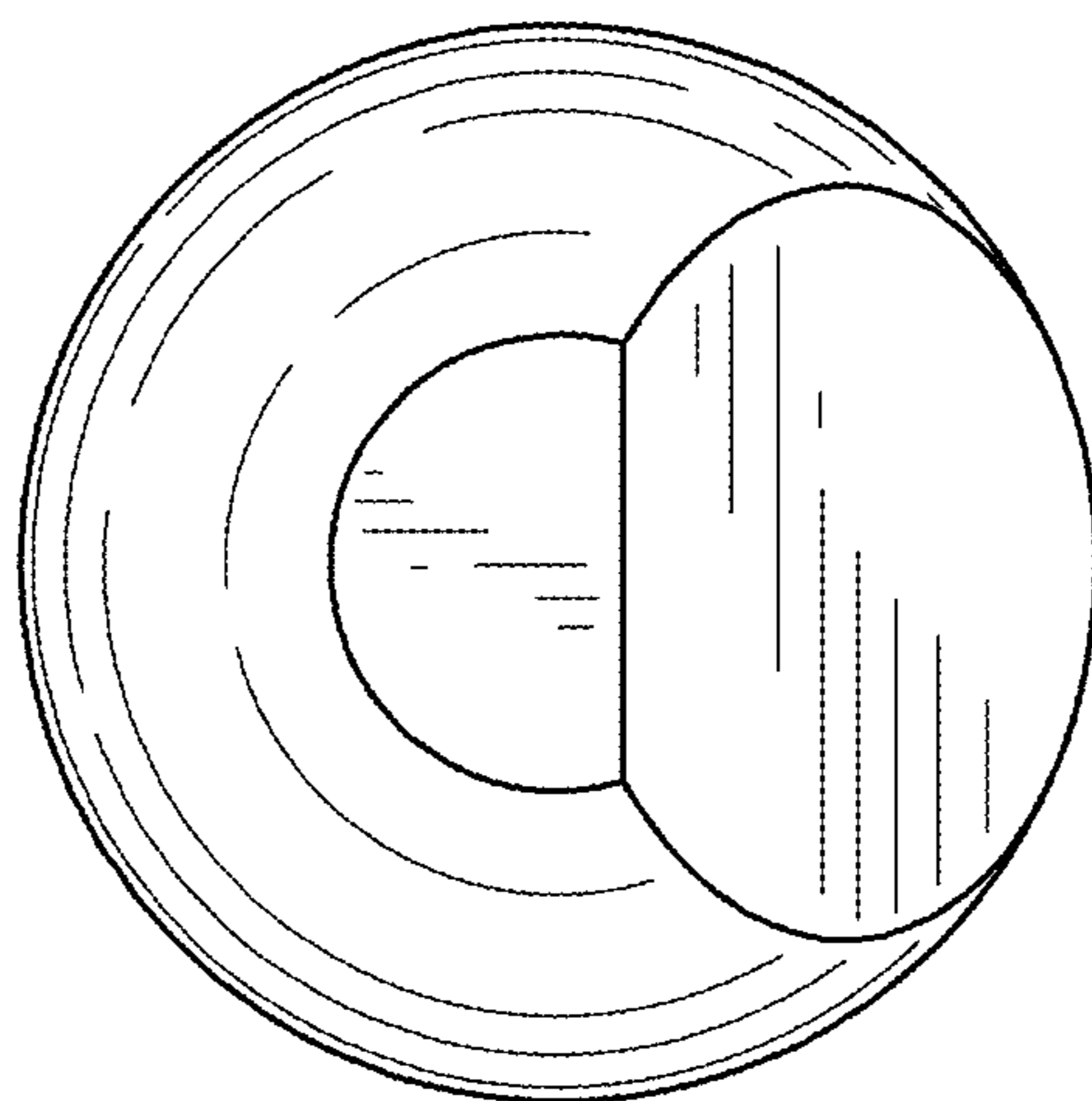

FIG. 6

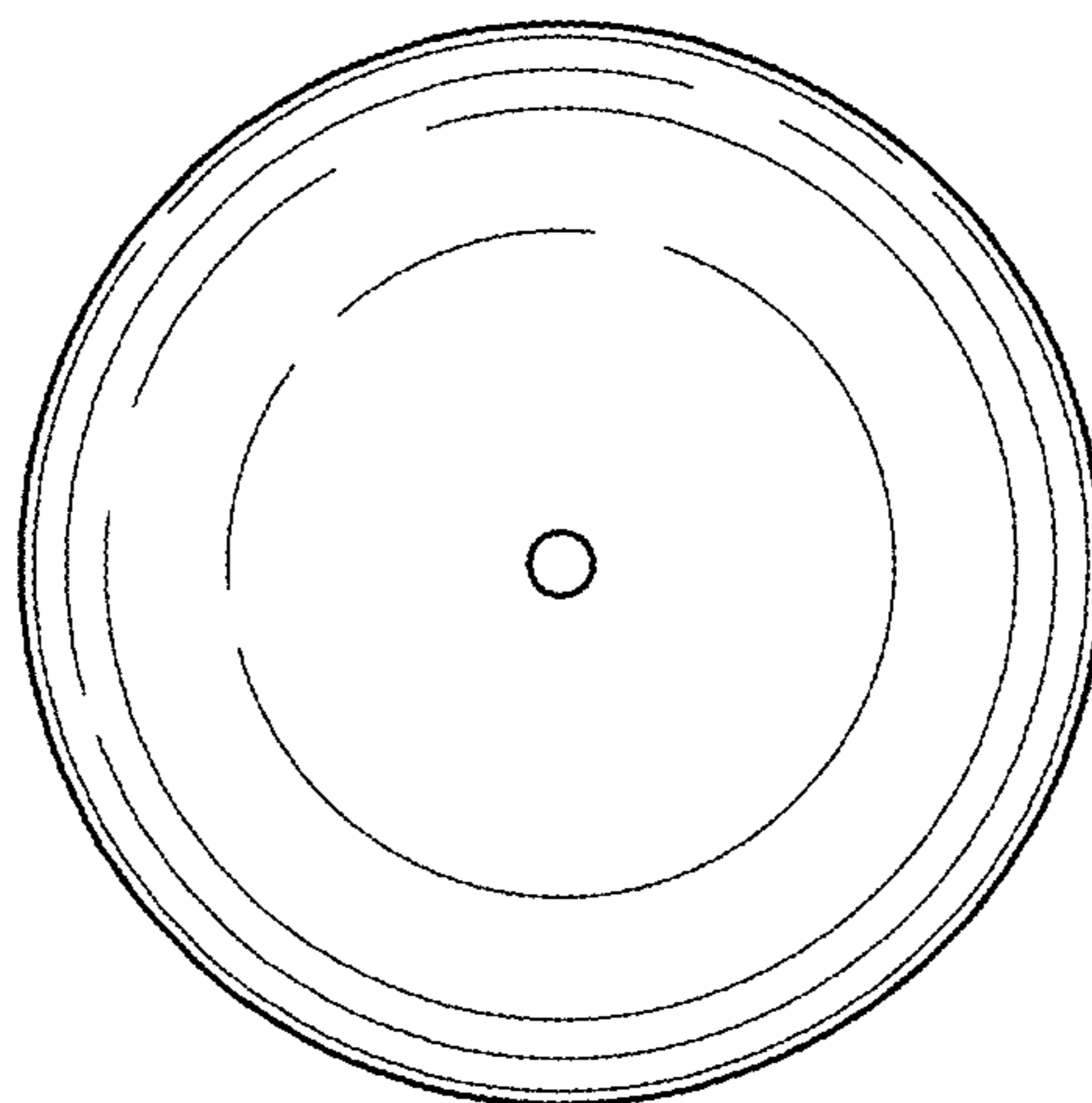

FIG. 7