

US00D795954S

(12) **United States Design Patent**  
**Hirota et al.**

(10) **Patent No.:** **US D795,954 S**

(45) **Date of Patent:** **\*\* Aug. 29, 2017**

(54) **PRINTER**

(71) Applicant: **Hewlett-Packard Development Company, L.P.**, Houston, TX (US)

(72) Inventors: **Akifumi Hirota**, Houston, TX (US);  
**Robin P. Yergenson**, Houston, TX (US); **Lori Segovia Blasch**, Houston, TX (US)

(73) Assignee: **Hewlett-Packard Development Company, L.P.**, Houston, TX (US)

(\*\*) Term: **14 Years**

(21) Appl. No.: **29/521,648**

(22) Filed: **Mar. 25, 2015**

(51) **LOC (10) Cl.** ..... **14-02**

(52) **U.S. Cl.**  
USPC ..... **D18/55**

(58) **Field of Classification Search**  
USPC ..... D18/36-39, 50, 54, 54.1, 55;  
D14/420-425  
CPC . B41J 3/4075; B41J 11/58; B41J 15/12; B41J 15/042; B41J 29/02; B41J 29/08; G06K 15/12; G06K 15/14  
See application file for complete search history.

(56) **References Cited**

**U.S. PATENT DOCUMENTS**

D697,964 S \* 1/2014 Fukasawa ..... D18/55

D724,141 S \* 3/2015 Kim ..... D18/55  
D749,169 S \* 2/2016 Kil ..... D18/55  
D755,284 S \* 5/2016 Terenzio ..... D18/50

\* cited by examiner

*Primary Examiner* — Cathy Anne MacCormac  
(74) *Attorney, Agent, or Firm* — Foley & Lardner

(57) **CLAIM**

We claim the ornamental design for a printer, as shown and described.

**DESCRIPTION**

FIG. 1 is a top, front, right side perspective view of an embodiment of the claimed design according to a first embodiment;

FIG. 2 is a front elevation view thereof;

FIG. 3 is a rear elevation view thereof;

FIG. 4 is a right side elevation view thereof;

FIG. 5 is a left side elevation view thereof;

FIG. 6 is a top plan view thereof; and,

FIG. 7 is a bottom plan view thereof.

The broken lines depict environmental subject matter and form no part of the claimed design. The use of stippling on specific surfaces in the drawings is used to show a contrast in appearance.

**1 Claim, 5 Drawing Sheets**

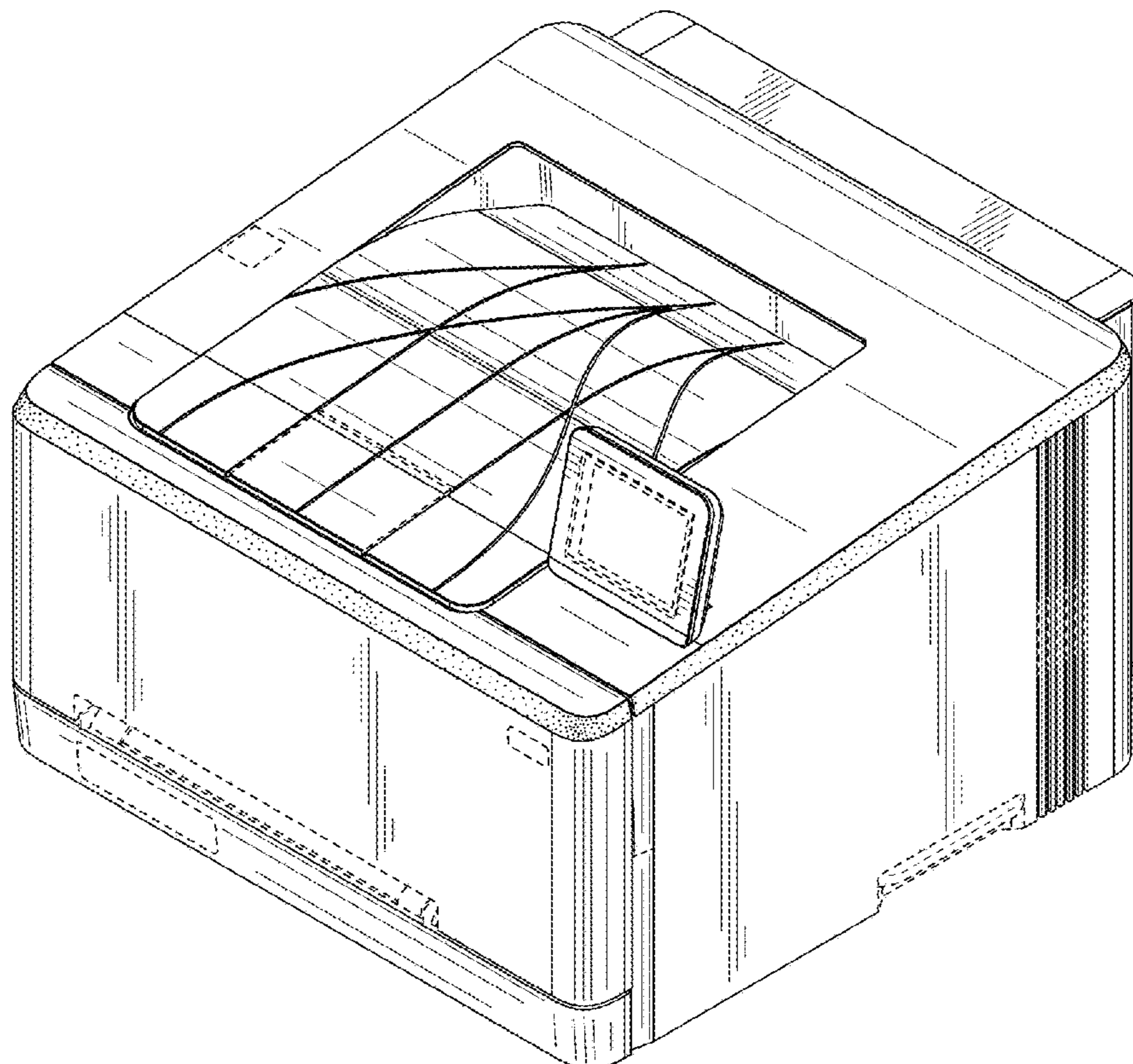

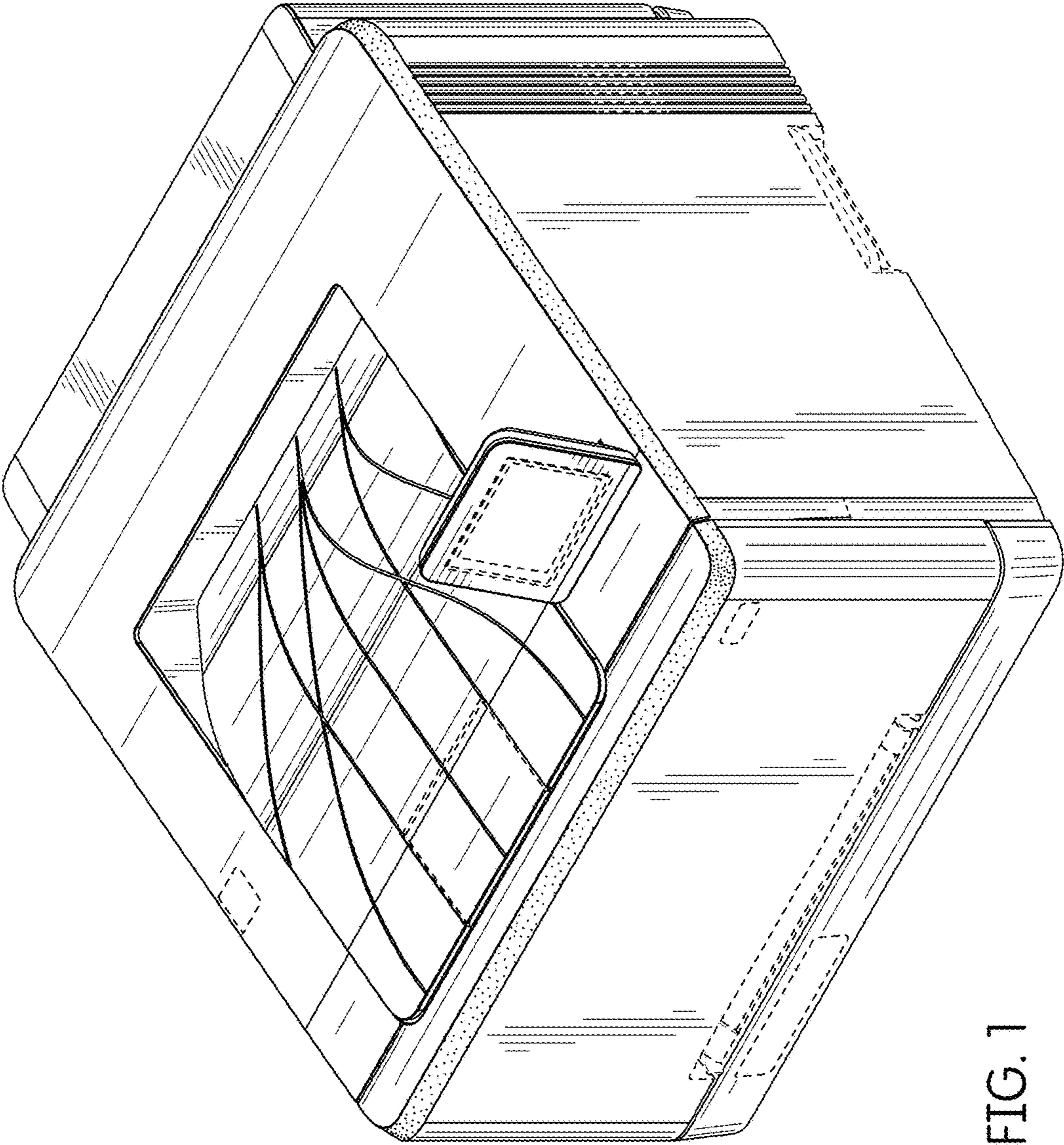

FIG. 1

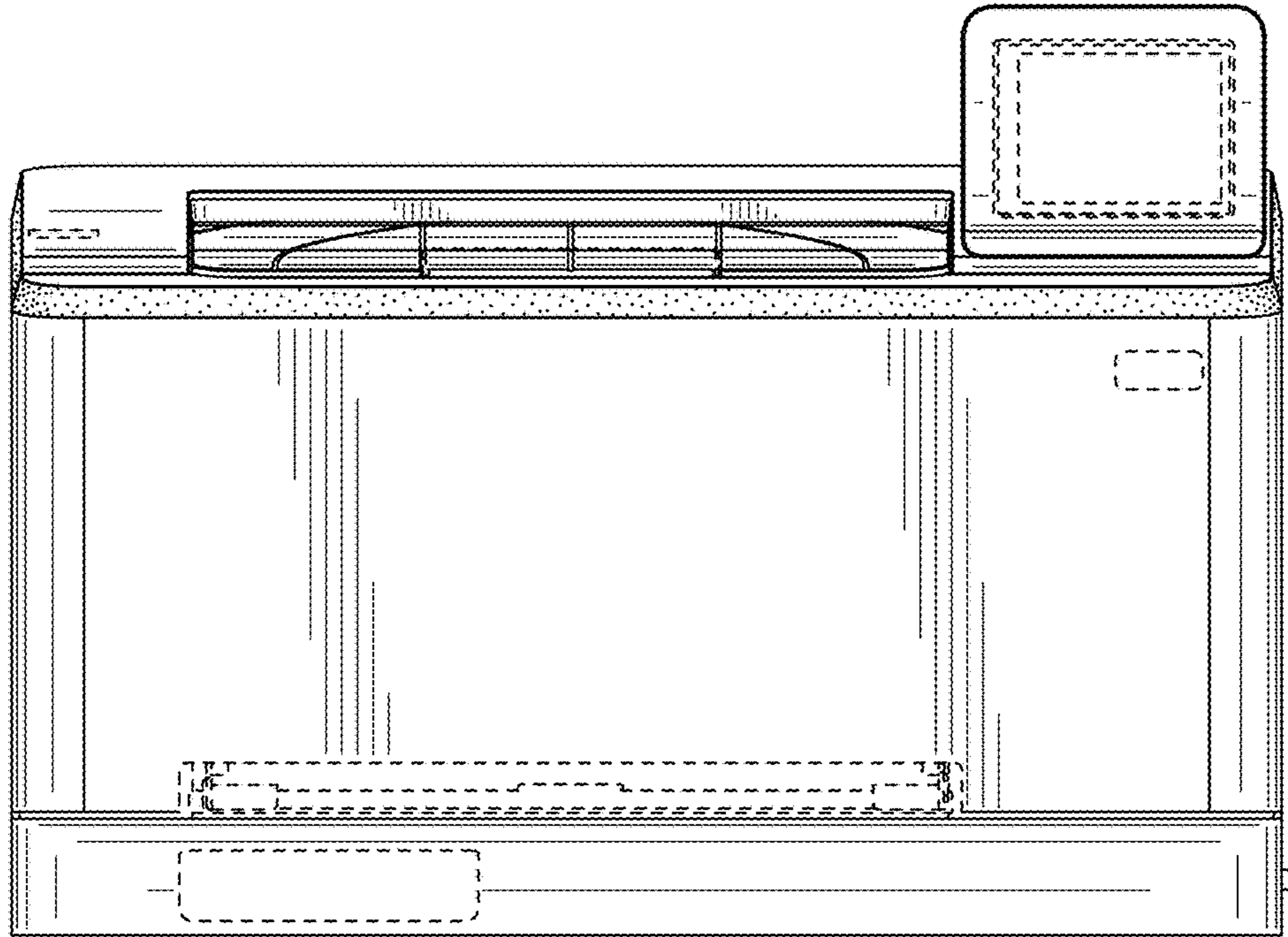

FIG. 2

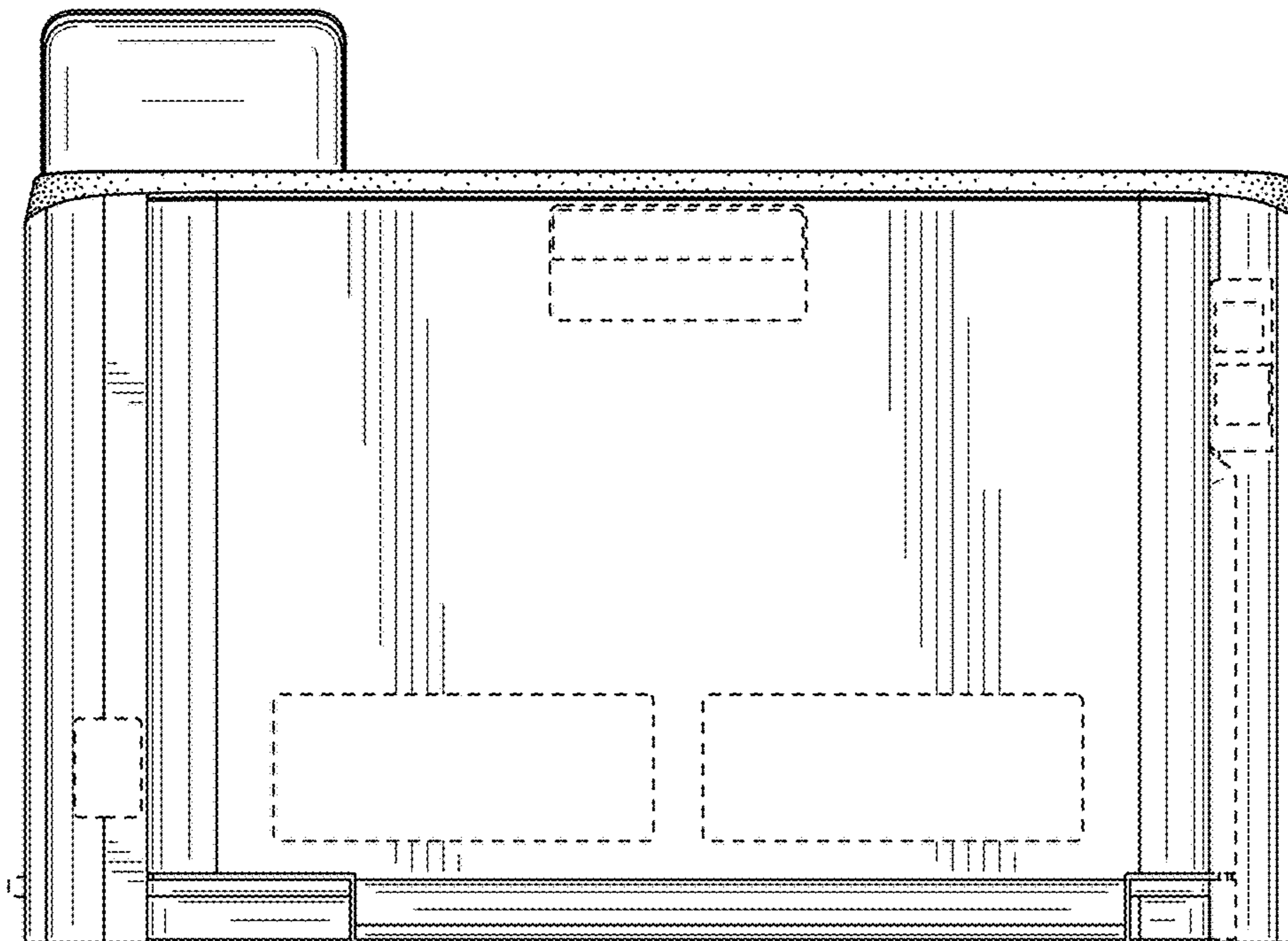

FIG. 3

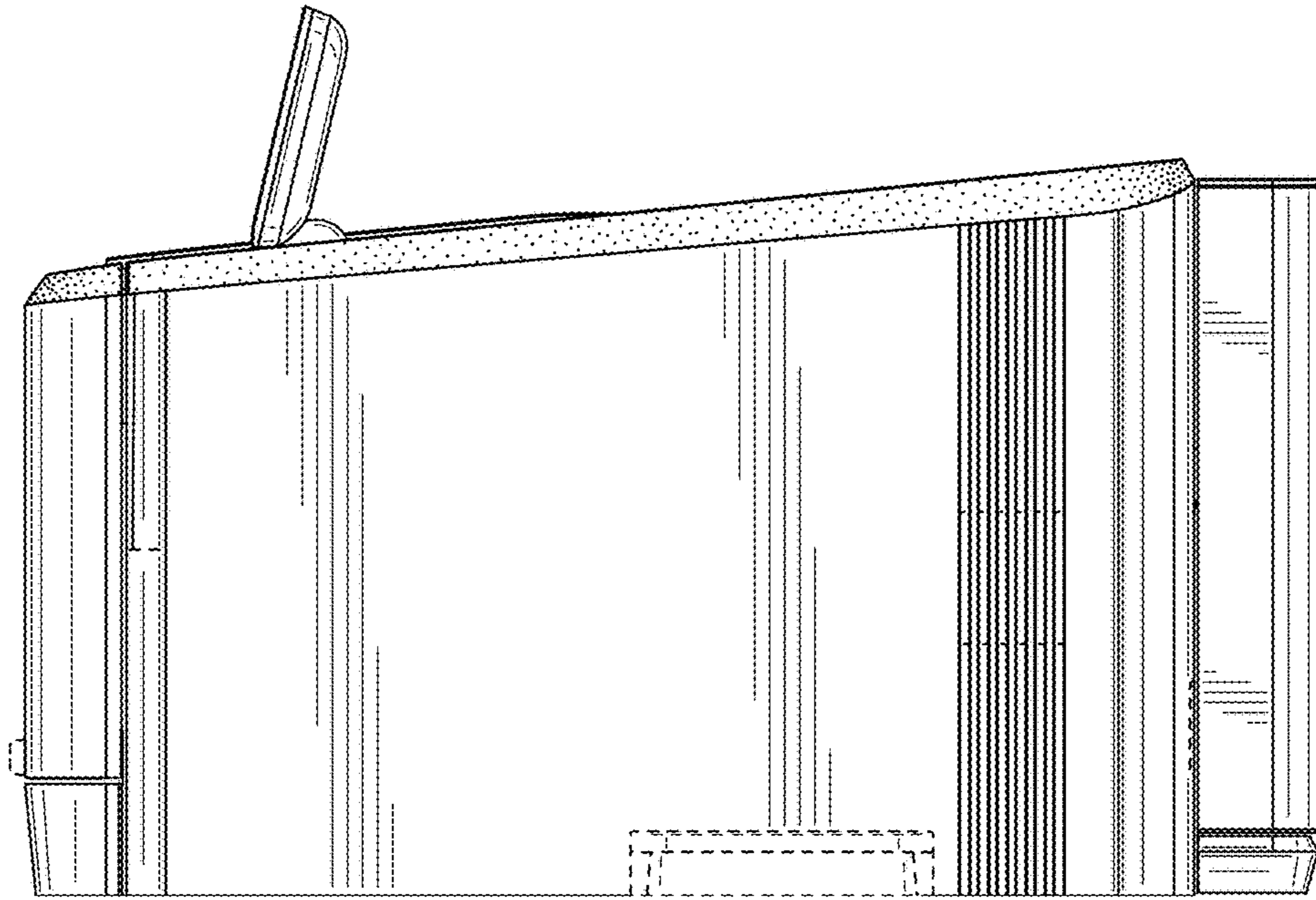

FIG. 4

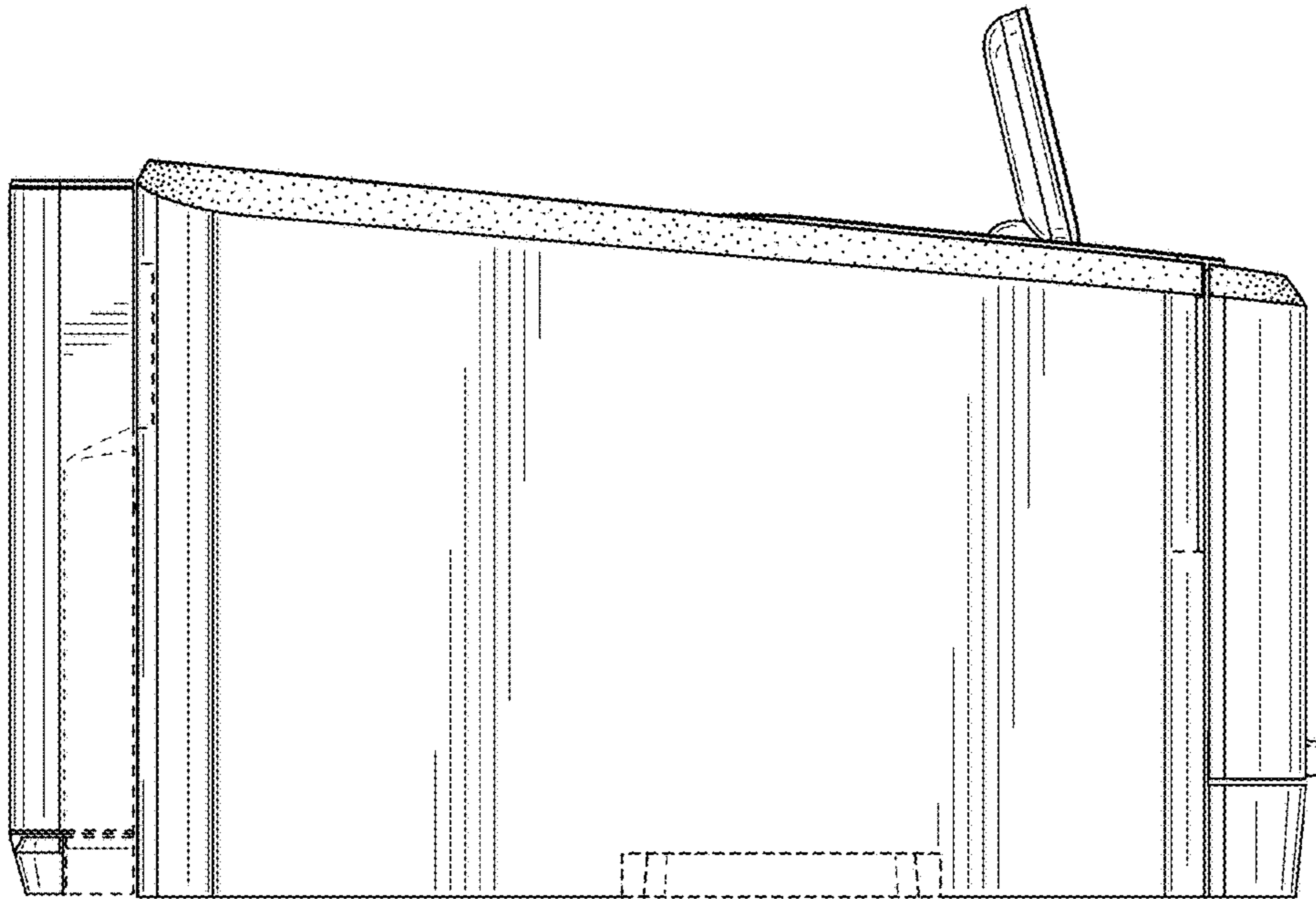

FIG. 5

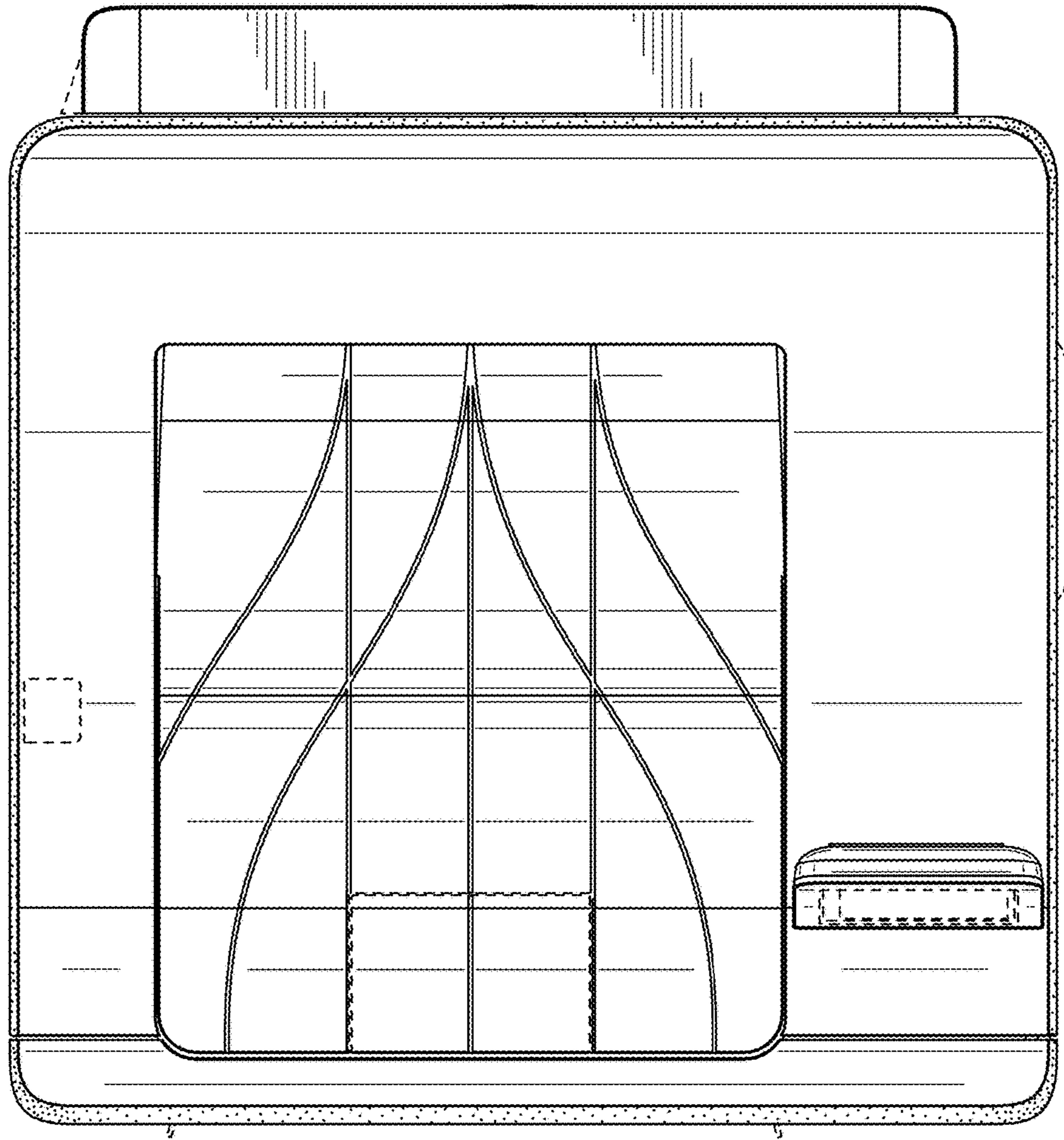

FIG. 6

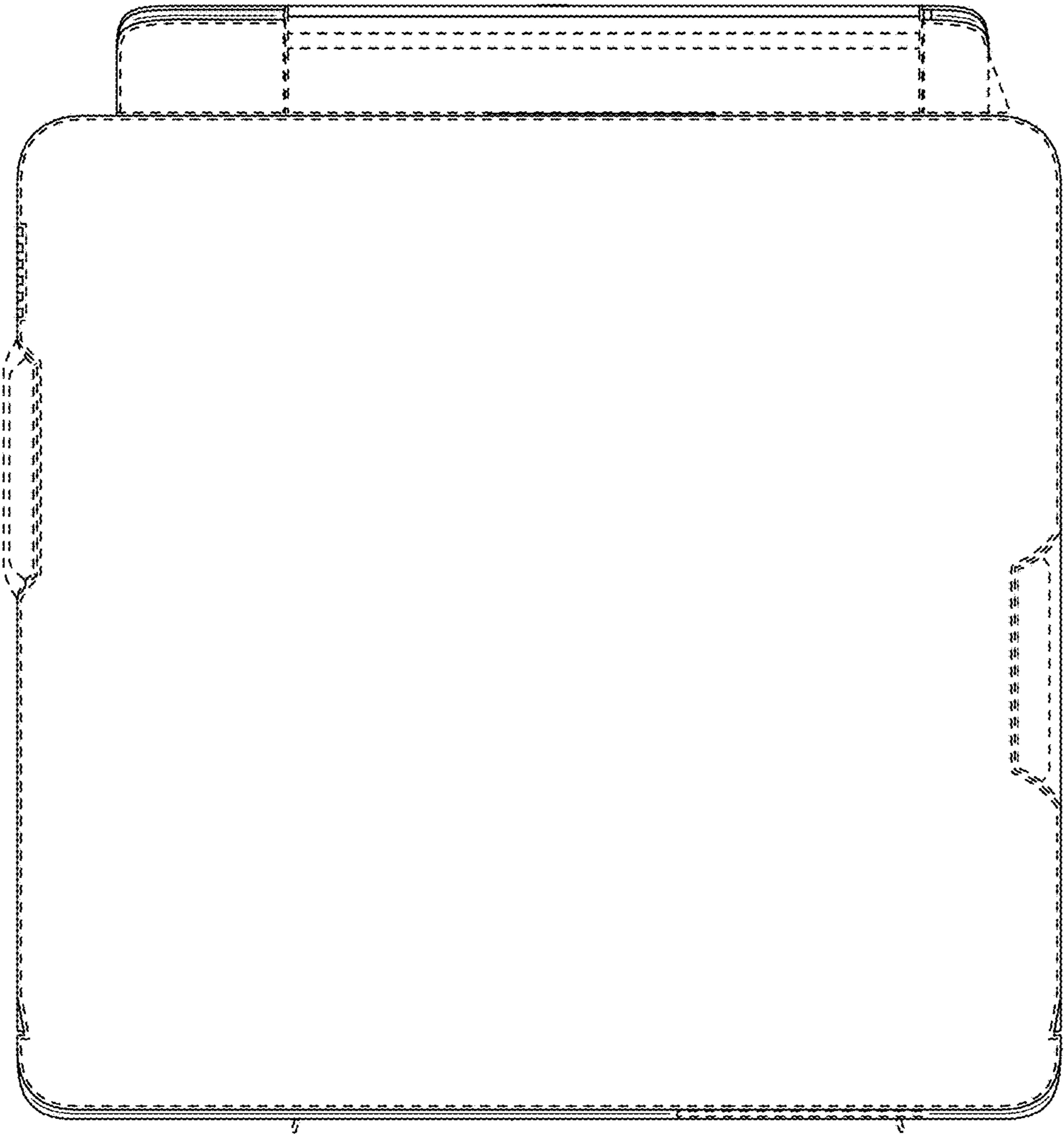

FIG. 7