



US00D795874S

(12) **United States Design Patent** (10) **Patent No.:** **US D795,874 S**
Szeremeta et al. (45) **Date of Patent:** **** Aug. 29, 2017**

(54) **RUGGEDIZED ENCLOSURE FOR A DATA STORAGE DEVICE**

(71) Applicant: **Western Digital Technologies, Inc.**, Irvine, CA (US)

(72) Inventors: **Wojciech Szeremeta**, Mission Viejo, CA (US); **Brian S. Nihei**, Fountain Valley, CA (US); **Steven T. Peng**, Irvine, CA (US)

(73) Assignee: **Western Digital Technologies, Inc.**, Irvine, CA (US)

(**) Term: **15 Years**

(21) Appl. No.: **29/505,661**

(22) Filed: **Dec. 23, 2015**

Related U.S. Application Data

(63) Continuation-in-part of application No. 13/308,410, filed on Nov. 30, 2011.

(51) **LOC (10) Cl.** **14-02**

(52) **U.S. Cl.**
USPC **D14/432; D3/273**

(58) **Field of Classification Search**
USPC D14/432, 440, 300-302, 314, 348-370, D14/383-385, 435, 474, 478, 483, 496, D14/125, 135, 155, 240-242, 299; D3/273, 201, 205, 218, 276, 282, 293,
(Continued)

(56) **References Cited**

U.S. PATENT DOCUMENTS

3,938,661 A 2/1976 Carmody
4,158,757 A 6/1979 Reichert et al.
D268,380 S 3/1983 Thiele

(Continued)

OTHER PUBLICATIONS

Western Digital Nomad im Hartetest a la Caschy. stadt-bremerhaven.de. (online) 7 pgs. Posted Sep. 2011. [retrieved on Jan. 8, 2017] <http://stadt-bremerhaven.de/western-digital-nomad-im-haertetest-a-la-caschy-video-inside/>.*

(Continued)

Primary Examiner — Susan Bennett Hattan

Assistant Examiner — Marie Fast Horse

(74) *Attorney, Agent, or Firm* — Knobbe, Martens, Olson & Bear, LLP

(57) **CLAIM**

The ornamental design for a ruggedized enclosure for a data storage device, as shown and described.

DESCRIPTION

FIG. 1 is a first top perspective view of a ruggedized enclosure for a data storage device embodying the new design;

FIG. 2 is a second top perspective view thereof with a sliding door being retracted and rotated as compared to FIG. 1 to illustrate a port on the ruggedized enclosure in an open position;

FIG. 3 is a top view of the ruggedized enclosure for a data storage device seen in FIG. 1;

FIG. 4 is a bottom view thereof;

FIG. 5 is a first side view thereof;

FIG. 6 is a second side view thereof;

FIG. 7 is a front view thereof; and,

FIG. 8 is a back view thereof.

Broken lines are used to illustrate features of the ruggedized enclosure for a data storage device which form no part of the claimed design. The broken lines consisting of a dash and a dot define the boundary of the claim, which extends to the boundary, but does not include the boundary.

1 Claim, 6 Drawing Sheets

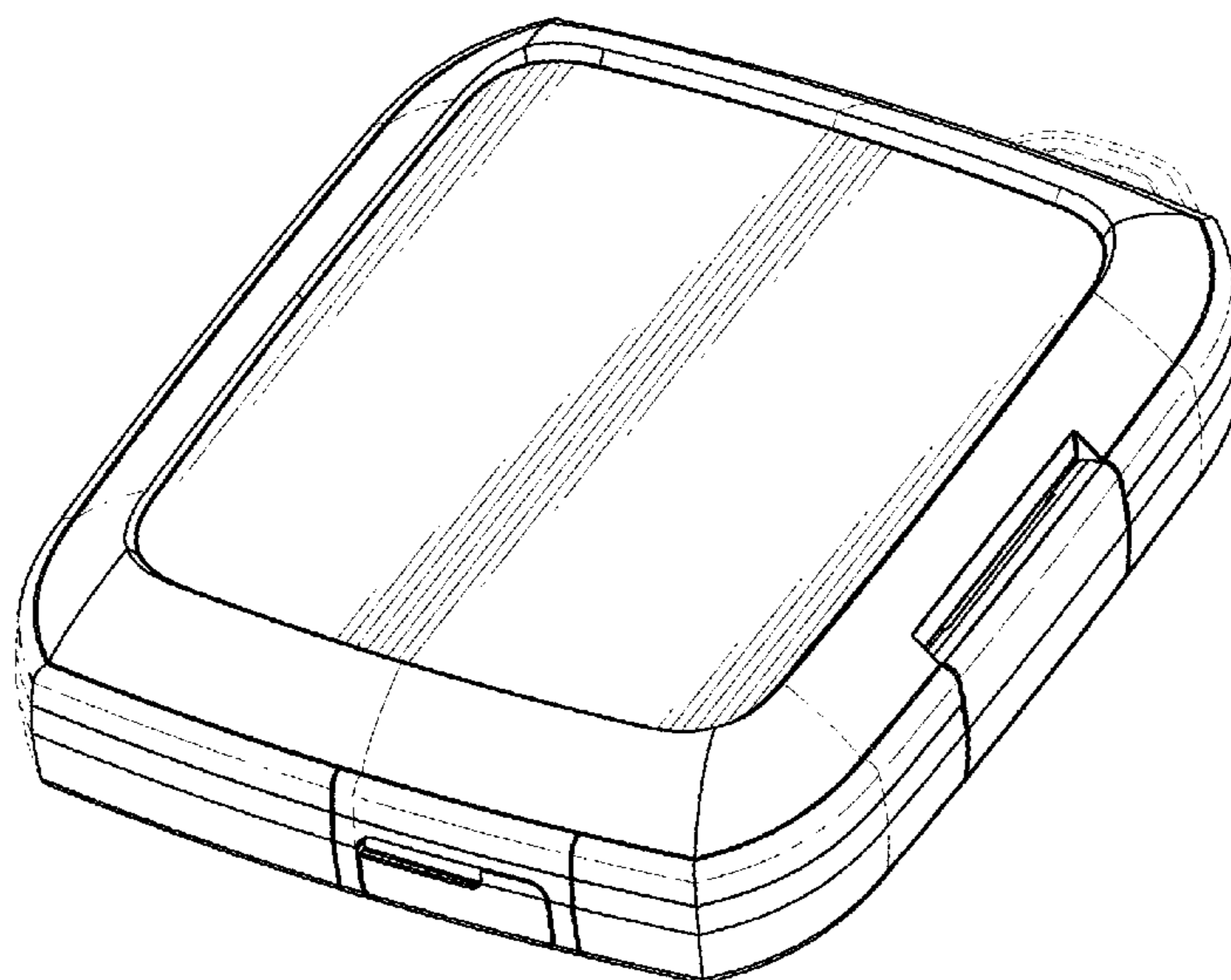

(58) **Field of Classification Search**
 USPC D3/294, 318, 321; D28/76, 78, 83, 84;
 D99/28, 43, 99
 CPC ... G11B 33/027; G11B 33/122; G11B 33/124;
 H05K 5/00; H05K 5/0213; H05K 5/04;
 G06F 1/1628; G06F 1/184; G06F 1/187;
 B65D 2585/00; B65D 2585/68; B65D
 2585/6835; B65D 2585/6837; A45C
 13/002; A45C 2013/025; A45C 2011/188
 See application file for complete search history.

(56) **References Cited**

U.S. PATENT DOCUMENTS

4,854,476 A 8/1989 Serio, Jr.
 4,866,934 A 9/1989 Lindstedt
 4,910,882 A 3/1990 Goller
 D309,832 S 8/1990 Hung
 5,045,636 A 9/1991 Johnsen et al.
 5,088,084 A 2/1992 Komiya et al.
 5,117,952 A 6/1992 Suh
 5,223,996 A 6/1993 Read et al.
 5,293,282 A 3/1994 Squires et al.
 5,422,766 A 6/1995 Hack et al.
 5,491,608 A 2/1996 Koyanagi et al.
 5,535,092 A 7/1996 Bang
 5,641,068 A 6/1997 Warner
 5,703,734 A 12/1997 Berberich et al.
 5,793,566 A 8/1998 Scura et al.
 D405,957 S * 2/1999 Test D3/289
 D419,297 S 1/2000 Richardson et al.
 D422,573 S 4/2000 Takano et al.
 6,073,770 A 6/2000 Park
 D436,958 S * 1/2001 Chen D14/363
 6,222,727 B1 4/2001 Wu
 D446,650 S 8/2001 Chen
 6,347,021 B2 2/2002 Kazmierczak et al.
 6,460,859 B1 10/2002 Hammi et al.
 D471,911 S * 3/2003 Takiguchi D14/299
 6,739,452 B2 5/2004 Rochelo
 6,749,446 B2 6/2004 Nechitailo
 6,840,381 B2 1/2005 Stephens
 6,845,006 B2 1/2005 Kobayashi
 D502,316 S * 3/2005 Chen D3/273
 6,891,723 B1 5/2005 Lin et al.
 6,896,134 B2 5/2005 Russell et al.
 D506,064 S 6/2005 Keegan et al.
 D511,774 S 11/2005 Tanio
 6,968,954 B2 11/2005 Hsieh
 6,969,548 B1 11/2005 Goldfine
 D516,807 S * 3/2006 Richardson D3/273
 D517,317 S 3/2006 Singh
 D532,785 S 11/2006 Lo et al.
 D534,909 S 1/2007 Weiher et al.
 D548,971 S * 8/2007 Lin D3/294
 D555,357 S 11/2007 Hsieh
 7,306,159 B1 * 12/2007 Rochelo A45C 11/18
 206/308.3
 D565,298 S * 4/2008 Braun D3/273
 7,362,541 B2 4/2008 Bernett et al.
 D569,616 S * 5/2008 Lin D3/273
 7,430,116 B2 9/2008 Liu
 7,475,816 B1 * 1/2009 Rochelo A45C 11/18
 206/308.1
 D587,267 S * 2/2009 Wang D14/356
 7,500,561 B2 3/2009 Matias et al.
 7,520,389 B2 4/2009 Lalouette
 7,584,851 B2 9/2009 Hong et al.
 D609,701 S * 2/2010 Hou D14/240
 7,701,705 B1 4/2010 Szeremeta
 D617,557 S 6/2010 Molina et al.
 7,810,639 B2 10/2010 Djulaini et al.
 7,886,903 B1 2/2011 Wurzelbacher, Jr. et al.
 D645,251 S * 9/2011 Lee D3/301
 D646,272 S 10/2011 Woo et al.
 8,064,194 B2 11/2011 Szeremeta

8,113,873 B1 2/2012 Sarraf
 8,133,426 B1 3/2012 Yurchenco et al.
 D668,866 S * 10/2012 Meng D3/273
 D674,393 S * 1/2013 Behar D14/440
 8,358,395 B1 1/2013 Szeremeta
 D677,464 S * 3/2013 Taylor D3/273
 8,417,979 B2 4/2013 Maroney
 8,462,460 B1 6/2013 Szeremeta et al.
 8,498,088 B1 7/2013 Klein
 8,547,658 B1 10/2013 Szeremeta
 D694,759 S * 12/2013 Chang D14/440
 D729,520 S * 5/2015 Koeniger D3/294
 D740,809 S * 10/2015 Kwon D14/250
 D749,846 S * 2/2016 Koeniger D3/294
 D753,917 S * 4/2016 Koeniger D3/294
 D758,065 S * 6/2016 Zwetzig D3/201
 2002/0114104 A1 8/2002 Hearn et al.
 2005/0115860 A1 6/2005 Mertz, II et al.
 2005/0150961 A1 * 7/2005 Porter A45C 11/18
 235/486
 2006/0076253 A1 4/2006 Hong et al.
 2006/0087763 A1 4/2006 Chua et al.
 2006/0158775 A1 7/2006 Sega et al.
 2008/0062636 A1 3/2008 Liu
 2009/0009945 A1 1/2009 Johnson et al.
 2009/0161309 A1 6/2009 Yang
 2010/0238623 A1 9/2010 Pan
 2011/0057392 A1 3/2011 Monnet et al.
 2013/0062468 A1 3/2013 Yokoi

OTHER PUBLICATIONS

WD Nomad Rugged Case. amazon.com. (Online Image) 1 pg. By Margie on Aug. 10, 2012. [retrieved on Jan. 8, 2017] <https://www.amazon.com/Western-Digital-WDBGRD0000NBK-NASN-Nomad-Rugged/dp/B00505EZZ6>.*

WD Nomad Rugged Case. amazon.com. (Online Image) 1 pg. Posted by Jay115 "Jay" Mar. 14, 2013. [retrieved on Jan. 8, 2017] <https://www.amazon.com/Western-Digital-WDBGRD0000NBK-NASN-Nomad-Rugged/dp/B00505EZZ6>.*

Advisory Action dated Jul. 3, 2014 from U.S. Appl. No. 13/308,423, 3 pages.
 Final Office Action dated Apr. 16, 2014 from U.S. Appl. No. 13/308,423, 15 pages.
 Office Action dated Jul. 12, 2013 from U.S. Appl. No. 13/430,455, 14 pages.
 Final Office Action dated Nov. 7, 2013 from U.S. Appl. No. 13/430,455, 9 pages.
 Advisory Action dated Jan. 22, 2014 from U.S. Appl. No. 13/430,455, 3 pages.
 Office Action dated Dec. 23, 2013 from U.S. Appl. No. 13/308,423, 29 pages.
 Office Action dated Nov. 27, 2012 from U.S. Appl. No. 13/430,455, 13 pages.
 Office Action dated Feb. 6, 2013 from U.S. Appl. No. 13/430,455, 7 pages.
 Interview Summary dated Apr. 4, 2013 from U.S. Appl. No. 13/430,455, 3 pages.
 Examiner's Answer to Appeal Brief dated Jun. 30, 2015 from U.S. Appl. No. 13/308,410, 11 pages.
 Advisory Action dated Dec. 10, 2014 from U.S. Appl. No. 13/308,410, 3 pages.
 Office Action dated Oct. 24, 2014 from U.S. Appl. No. 13/308,410, 8 pages.
 Office Action dated Jul. 11, 2014 from U.S. Appl. No. 13/308,410, 9 pages.
 Advisory Action dated Jan. 7, 2014 from U.S. Appl. No. 13/308,410, 3 pages.
 Office Action dated Nov. 5, 2013 from U.S. Appl. No. 13/308,410, 8 pages.
 Office Action dated Jul. 15, 2013 from U.S. Appl. No. 13/308,410, 6 pages.
 Office Action dated Feb. 6, 2013 from U.S. Appl. No. 13/308,410, 7 pages.

(56)

References Cited

OTHER PUBLICATIONS

Office Action dated Nov. 15, 2012 from U.S. Appl. No. 13/308,410,
7 pages.

Office Action dated Jun. 25, 2014 from U.S. Appl. No. 13/430,455,
12 Pages.

* cited by examiner

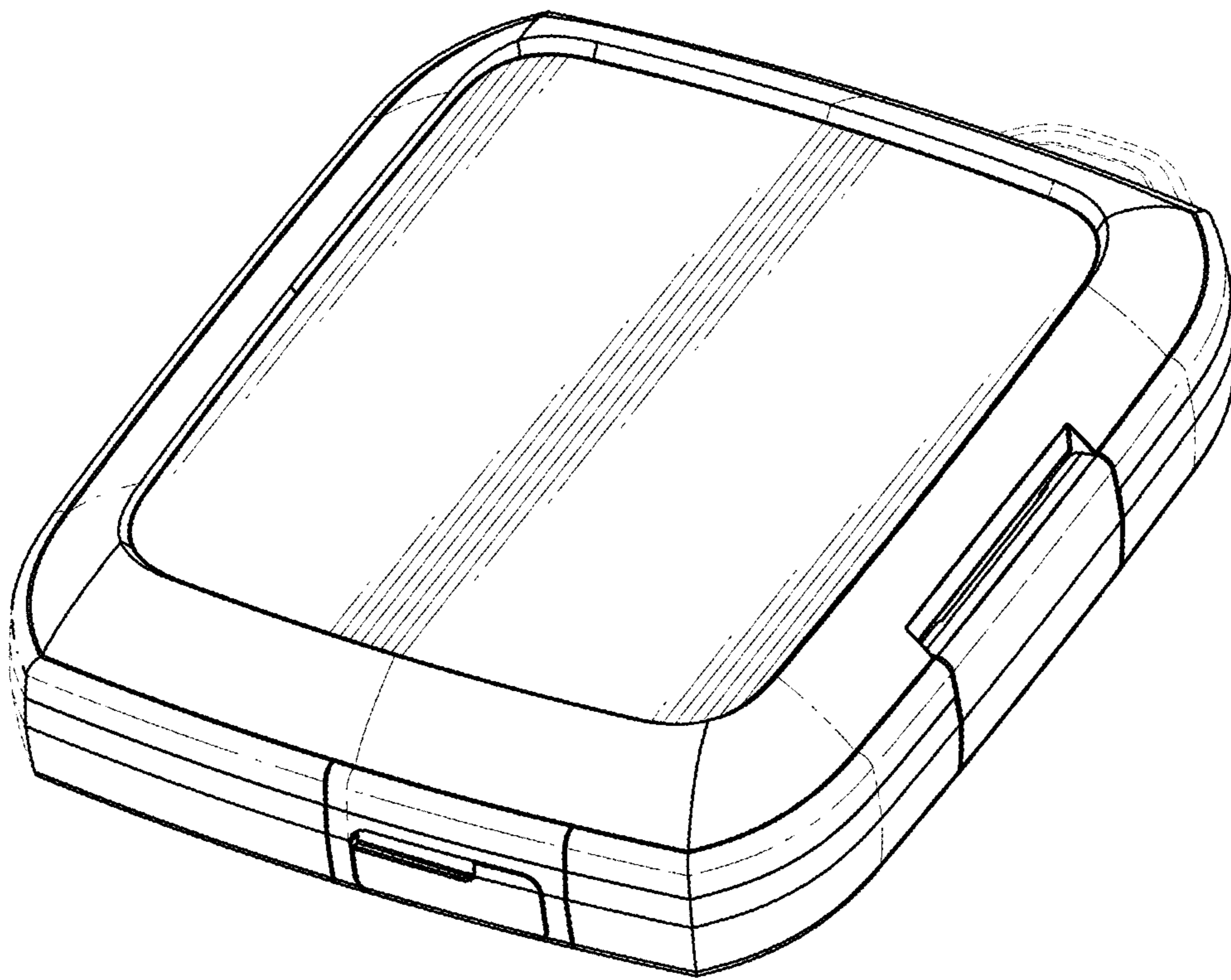

FIG. 1

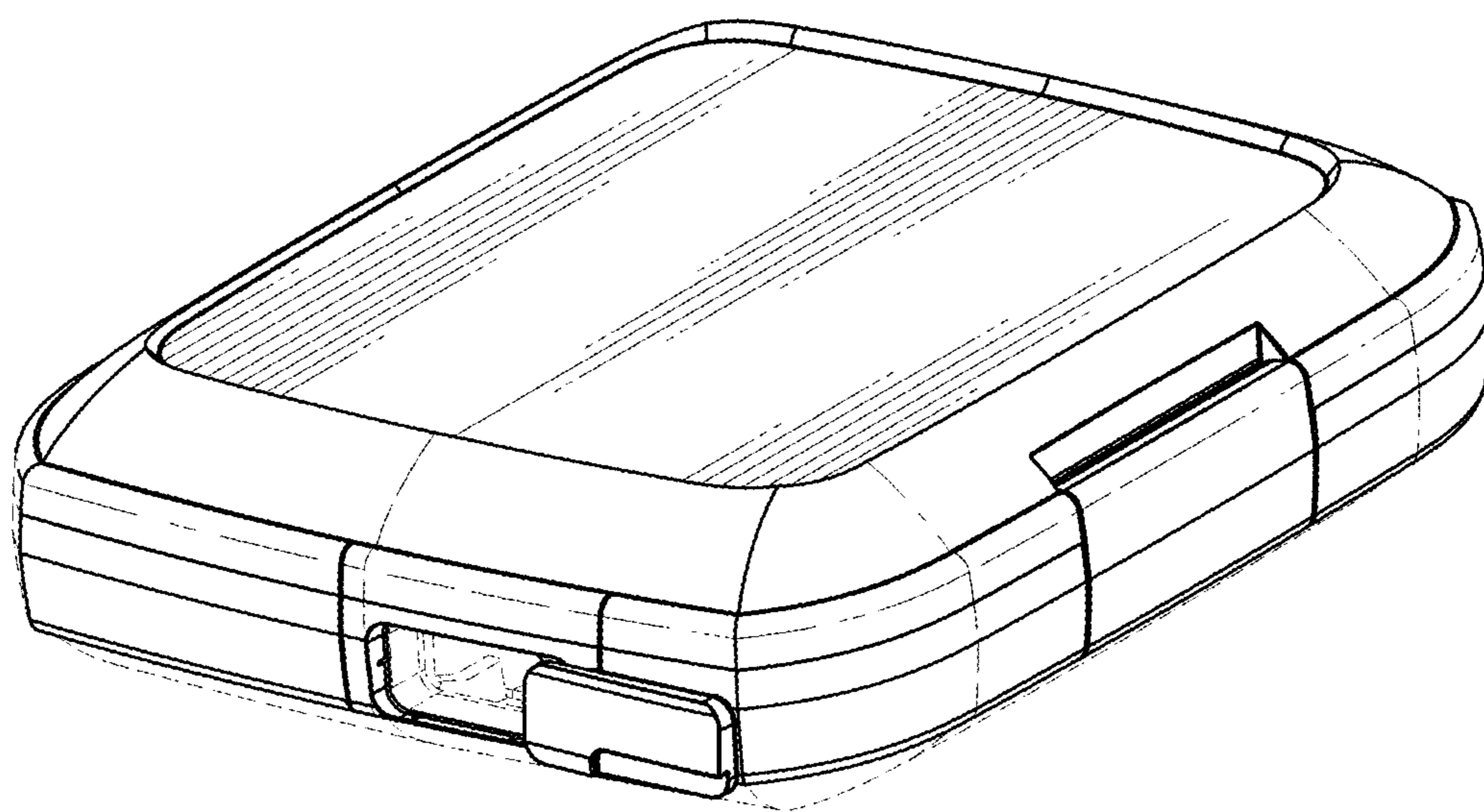

FIG. 2

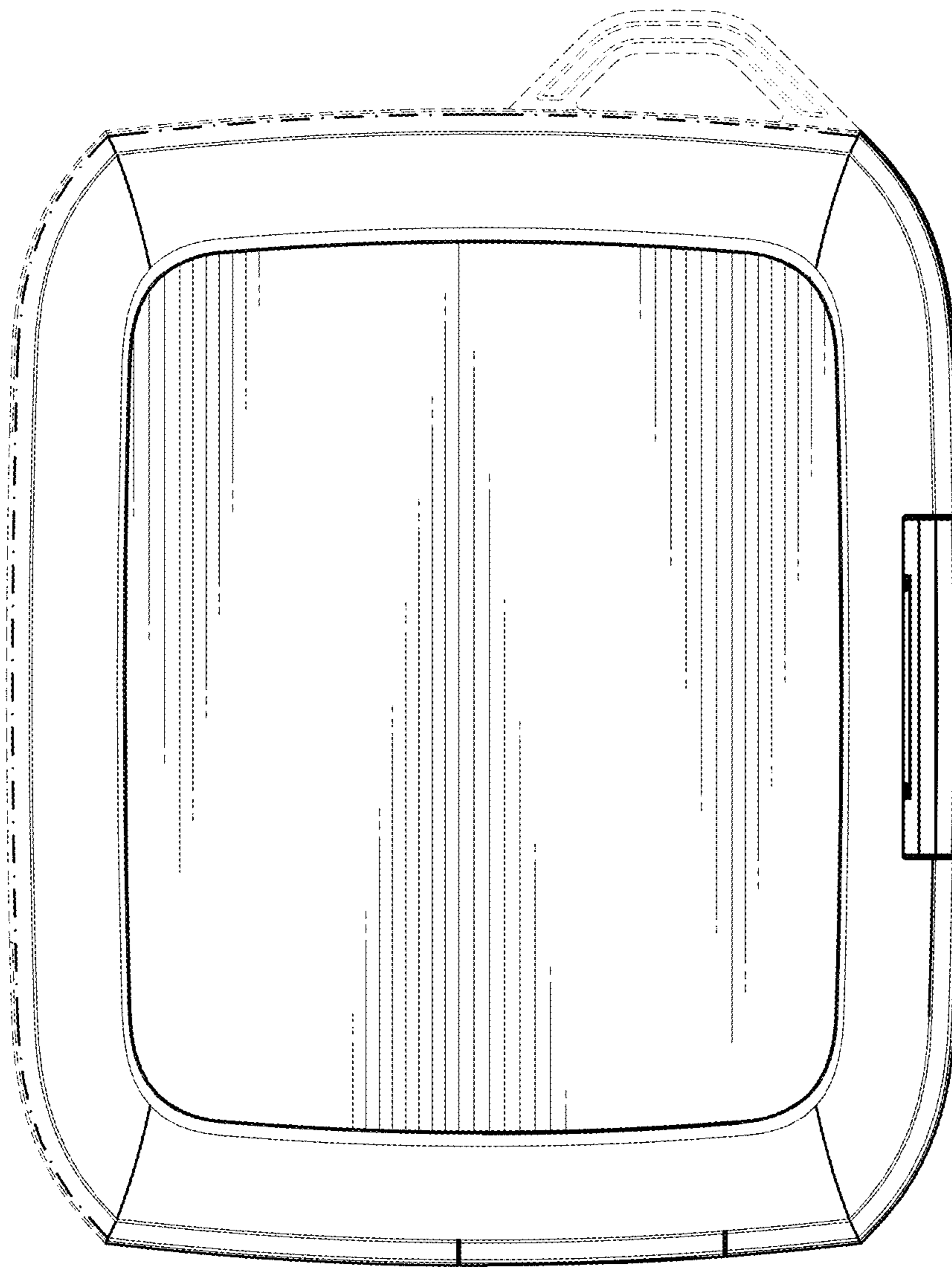

FIG. 3

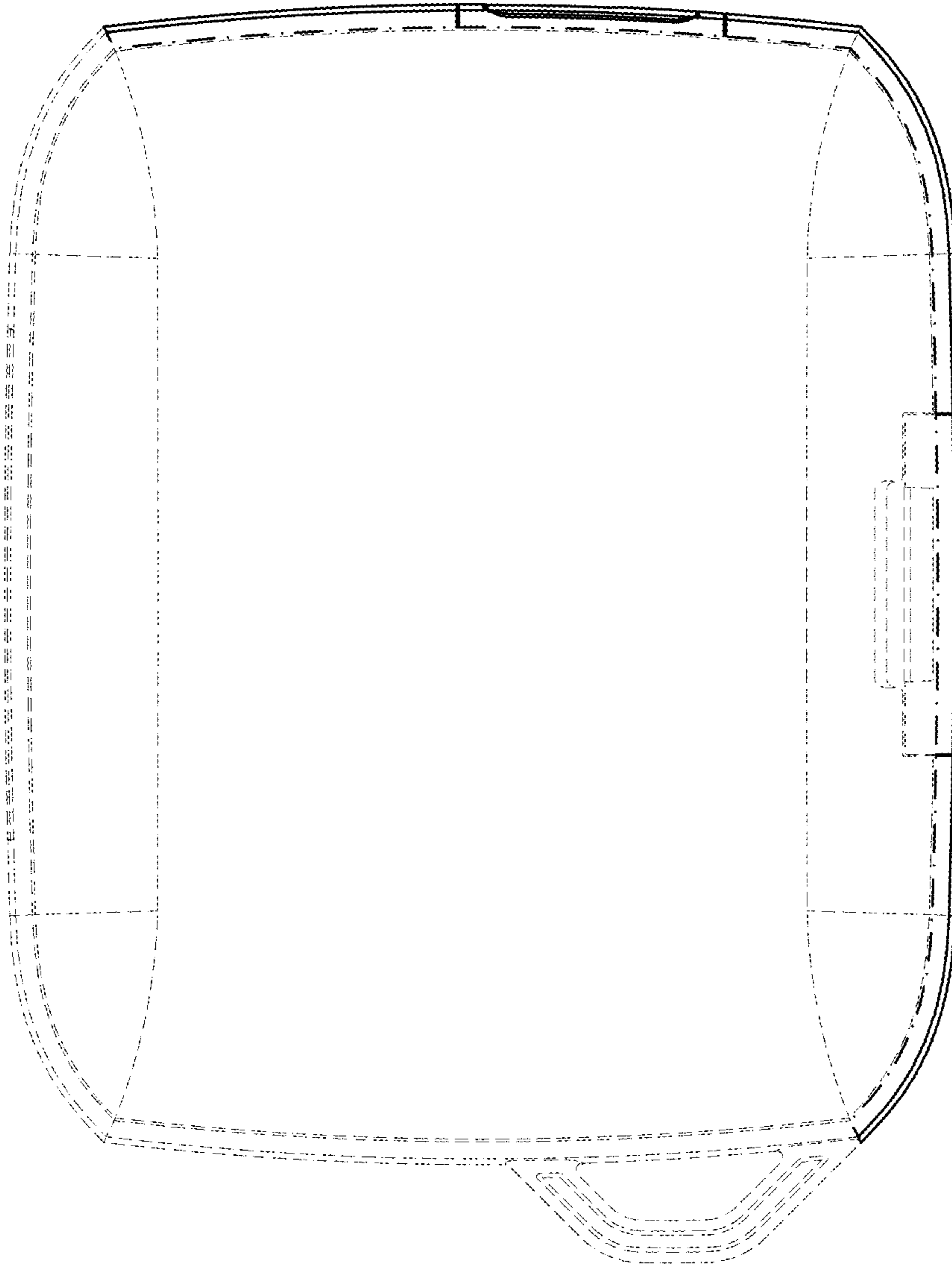

FIG. 4

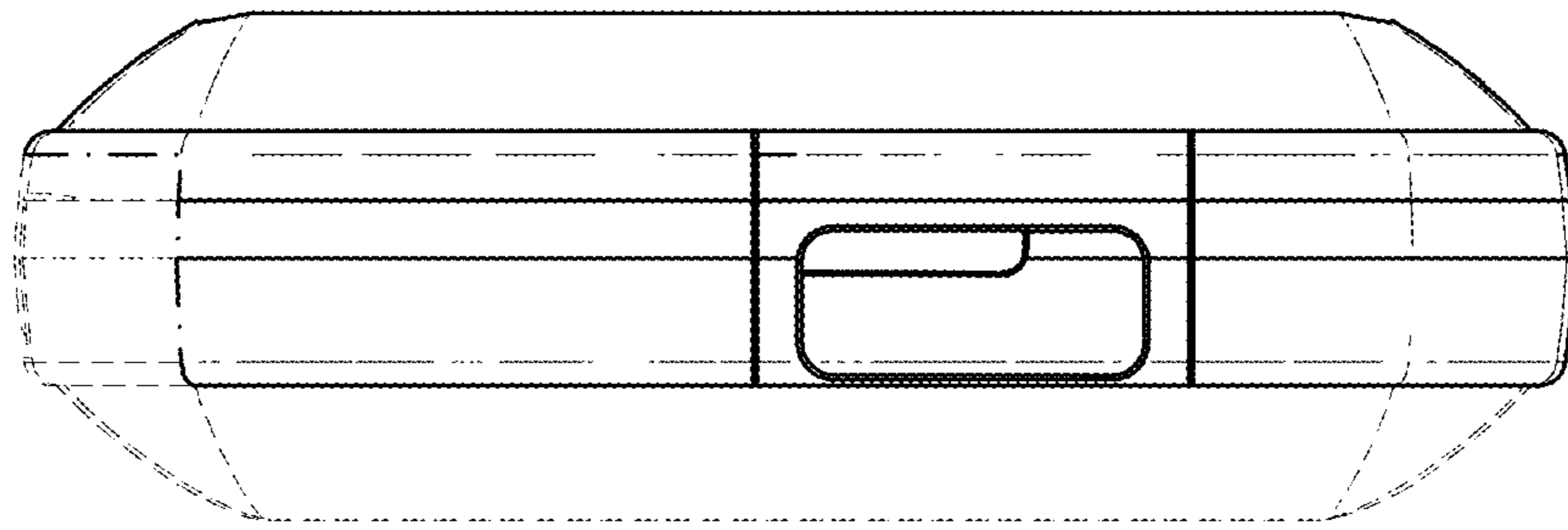

FIG. 5

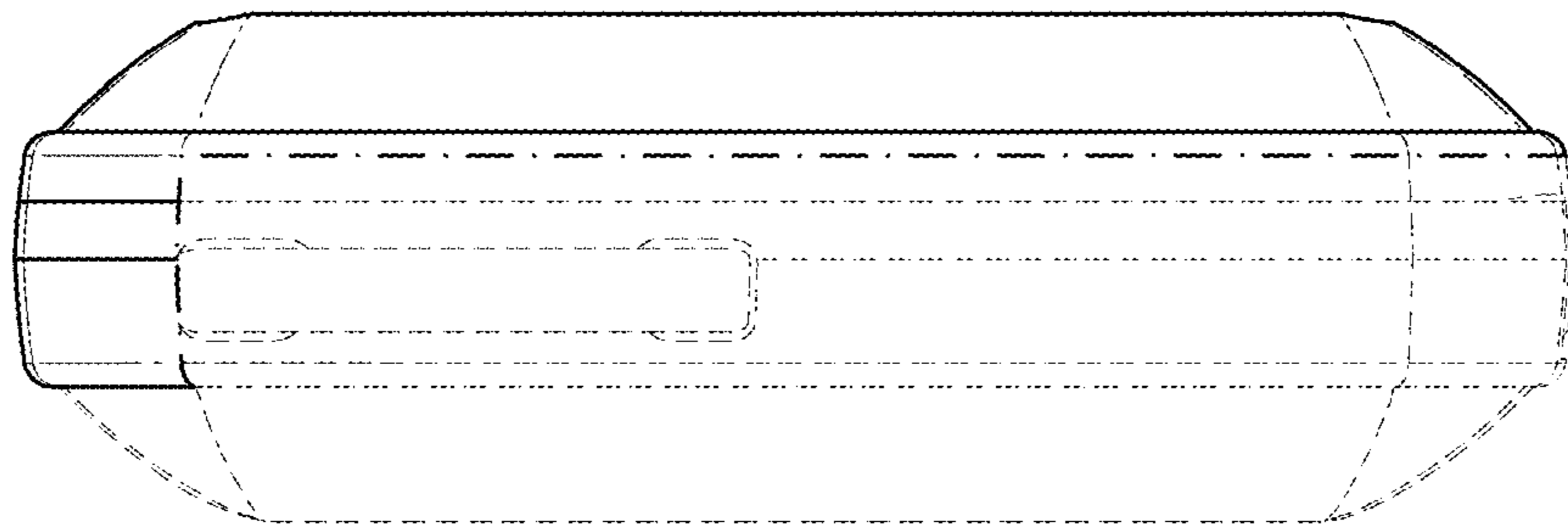

FIG. 6

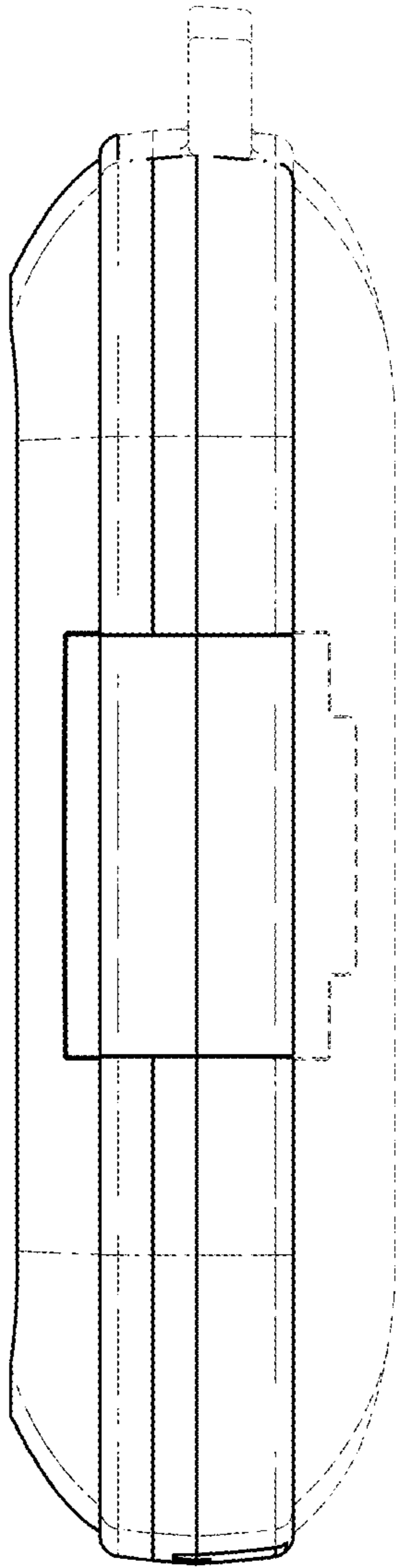

FIG. 7

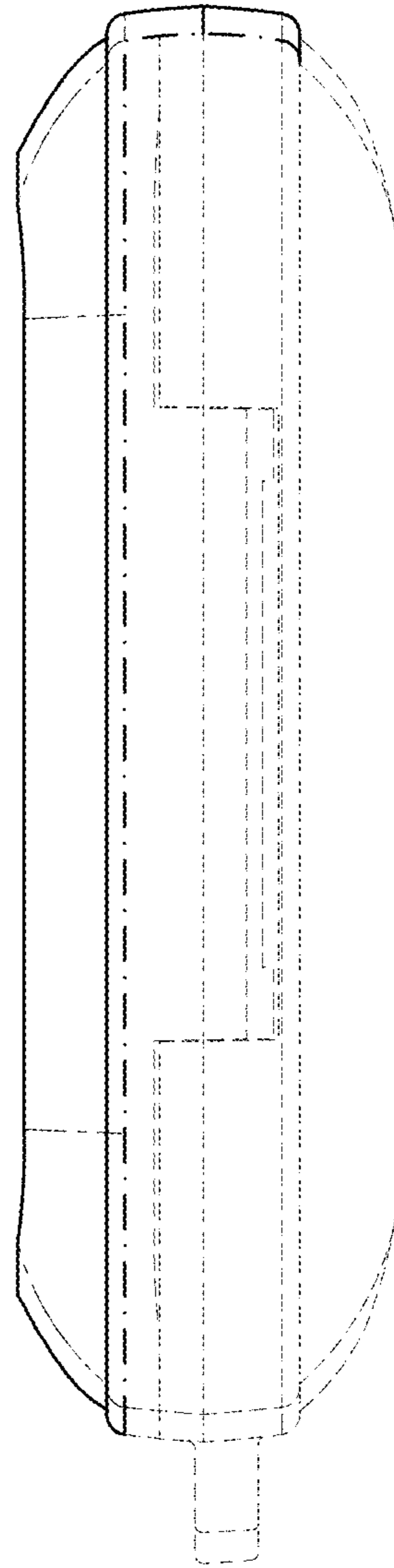

FIG. 8