



US00D795752S

(12) **United States Design Patent** (10) **Patent No.:** **US D795,752 S**
Wang et al. (45) **Date of Patent:** **** Aug. 29, 2017**

(54) **ROLLATOR**
(71) Applicant: **Medline Industries, Inc.**, Mundelein, IL (US)

D281,771 S 12/1985 Webb
D289,507 S 4/1987 Danielsson
5,058,912 A 10/1991 Harroun
(Continued)

(72) Inventors: **Zhiliang Wang**, Zhongshan (CN);
Margaret Mary Andersen, Chicago, IL (US); **Brian Monegas Ramirez**,
Chicago, IL (US)

FOREIGN PATENT DOCUMENTS

DE 29717488 U1 11/1997
EP 2343035 8/2012
(Continued)

(73) Assignee: **Medline Industries, Inc.**, Northfield, IL (US)

OTHER PUBLICATIONS

(**) Term: **15 Years**

“Adjustable Rollator by Patterson Medical”, Medline product currently available at <https://www.medline.com/product/Adjustable-Rollator-by-Patterson-Medical/Rollators/Z05-PF55372?question=rollator&index=P35&indexCount=35>.

(21) Appl. No.: **29/559,421**

(22) Filed: **Mar. 28, 2016**

(Continued)

Related U.S. Application Data

(63) Continuation of application No. 29/536,690, filed on Aug. 19, 2015, now Pat. No. Des. 754,568, which is a continuation of application No. 29/477,933, filed on Dec. 30, 2013, now Pat. No. Des. 739,314.

Primary Examiner — Charles Hanson

(74) *Attorney, Agent, or Firm* — Fitch, Even, Tabin & Flannery LLP

(51) **LOC (10) Cl.** **12-12**

(52) **U.S. Cl.**
USPC **D12/130**

(58) **Field of Classification Search**
USPC D12/128–133
CPC A61G 5/10; A61G 2005/1054; A61G 5/08;
A61G 5/00; A61G 2005/0891; A61G
2005/0825; A61G 5/14; B62M 1/14
See application file for complete search history.

(57) **CLAIM**

We claim the ornamental design for a rollator, as shown and described.

(56) **References Cited**

U.S. PATENT DOCUMENTS

474,666 A 5/1892 Krehbiel
3,186,759 A 6/1965 Reeves
3,338,628 A 8/1967 Evans
4,211,309 A 7/1980 Ruggiero
4,229,039 A 10/1980 Day
4,341,381 A 7/1982 Norberg

DESCRIPTION

FIG. 1 is a front perspective view of a rollator in accordance with our new design;
FIG. 2 is a rear perspective view thereof;
FIG. 3 is a right side elevational view thereof;
FIG. 4 is a left side elevational view thereof;
FIG. 5 is a front elevational view thereof;
FIG. 6 is a rear elevational view thereof;
FIG. 7 is a top plan view thereof; and,
FIG. 8 is a bottom plan view thereof.
The broken lines are included for the purpose of illustrating the unclaimed portions of the rollator and form no part of the claim.

1 Claim, 8 Drawing Sheets

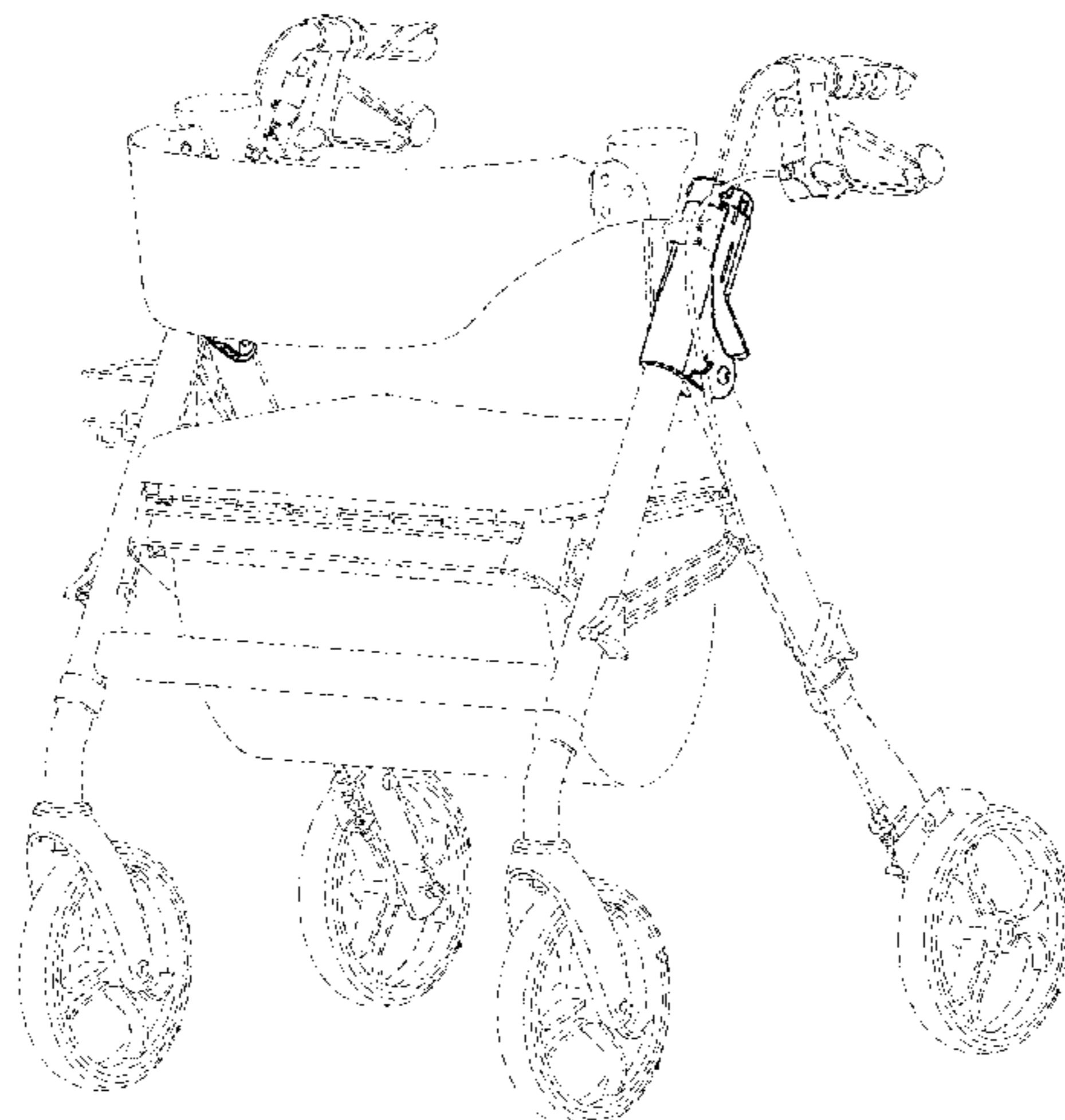

(56)

References Cited

U.S. PATENT DOCUMENTS

5,060,967 A 10/1991 Hulterstum
 5,224,731 A 7/1993 Johnson
 5,320,122 A 6/1994 Jacobson, II
 5,364,120 A 11/1994 Shimansky
 5,419,571 A 5/1995 Vaughan
 D360,174 S 7/1995 Kjell
 D367,833 S 3/1996 Ahlbertz
 D372,890 S 8/1996 Ferm
 5,716,063 A 2/1998 Doyle
 5,741,020 A 4/1998 Harroun
 5,772,234 A 6/1998 Luo
 D396,437 S 7/1998 Liljedahl
 5,904,168 A 5/1999 Alulyan
 6,338,493 B1 1/2002 Wohlgemuth
 6,378,883 B1 4/2002 Epstein
 D503,909 S 4/2005 Tolfsen
 D519,423 S 4/2006 Tolfsen
 7,192,043 B1 3/2007 McLuen
 7,219,906 B2 5/2007 Hallgrimsson
 7,306,246 B2 12/2007 Gale
 D560,563 S 1/2008 Fransson
 7,370,734 B2 5/2008 Hallgrimsson
 7,379,734 B2 5/2008 Sato
 7,484,740 B2 2/2009 Miller
 7,628,411 B2 12/2009 Meyers
 D623,992 S 9/2010 Derks
 D633,830 S 3/2011 Derks
 7,918,473 B2 4/2011 Yao
 8,083,240 B2 12/2011 Jacobs
 8,226,111 B2 7/2012 Valdez
 8,596,669 B2 12/2013 Liao
 8,646,804 B2 2/2014 Derks
 8,851,502 B2 10/2014 Gaudiano
 8,936,262 B2 1/2015 Nabeta
 8,979,114 B2 3/2015 Cheng
 8,998,222 B2 4/2015 Huang
 8,998,223 B2 4/2015 Chang
 D736,121 S 8/2015 Wang
 D739,314 S 9/2015 Wang
 9,173,802 B2 11/2015 Willis
 9,226,868 B2 * 1/2016 Andersen A61H 3/04
 D754,034 S 4/2016 Wang
 D754,568 S 4/2016 Wang
 D766,139 S * 9/2016 Chen D12/130
 2002/0050697 A1 5/2002 Hallgrimsson
 2002/0079663 A1 6/2002 Hallgrimsson
 2002/0153684 A1 10/2002 Sung
 2004/0079405 A1 4/2004 Sanders
 2004/0104559 A1 6/2004 Chen
 2004/0118640 A1 6/2004 Hallgrimsson
 2004/0245737 A1 12/2004 Hallgrimsson
 2005/0001398 A1 1/2005 Serhan
 2006/0284040 A1 12/2006 Nixon
 2007/0034243 A1 2/2007 Miller
 2007/0170699 A1 7/2007 Li
 2007/0235067 A1 * 10/2007 Gale A61H 3/04
 135/67
 2007/0267054 A1 11/2007 Meyers
 2007/0283990 A1 * 12/2007 Fernandez A61G 5/08
 135/67
 2008/0111349 A1 5/2008 Willis
 2008/0129016 A1 6/2008 Willis
 2008/0135077 A1 6/2008 Meyers
 2008/0202571 A1 * 8/2008 Meyers A61H 3/04
 135/66
 2008/0252043 A1 * 10/2008 Willis A61H 3/04
 280/639
 2009/0033052 A1 2/2009 Bradshaw
 2010/0301574 A1 12/2010 Derks
 2012/0205882 A1 * 8/2012 Staggs A61G 5/1002
 280/30
 2013/0292916 A1 * 11/2013 Nabeta A61H 3/04
 280/47.371

2014/0084559 A1 * 3/2014 Fang A61H 3/04
 280/47.38

2014/0125037 A1 5/2014 Andersen
 2015/0182394 A1 7/2015 Kutsch
 2016/0113833 A1 4/2016 Andersen

FOREIGN PATENT DOCUMENTS

JP D1148308 7/2002
 JP D1292289 1/2007
 TW D107853 11/2005
 TW D127741 3/2009

OTHER PUBLICATIONS

“Bariatric RollAider™ by Patterson Medical”, Medline product currently available at <https://www.medline.com/product/Bariatric-RollAider153-by-Patterson-Medical/Rollators/Z05-PF74285?question=rollator&index=P43&indexCount=43>.
 “Basic Rollators”, Medline product currently available at <https://www.medline.com/product/Basic-Rollators/Rollators/Z05-PF04832?question=rollator&index=P4&indexCount=4>.
 “Basic Steel Rollators”, Medline product currently available at <https://www.medline.com/product/Basic-Steel-Rollators/Rollators/Z05-PF61071?question=rollator&index=P10&indexCount=10>.
 “Deluxe Comfort Rollators”, Medline product currently available at <https://www.medline.com/product/Deluxe-Comfort-Rollators/Rollators/Z05-PF61367?question=rollator&index=P8&indexCount=8>.
 “Deluxe Rollators”, Medline product currently available at <https://www.medline.com/product/Deluxe-Rollators/Rollators/Z05-PF04834?question=rollator&index=P6&indexCount=6>.
 “Empower Rollator”, Medline product currently available at <https://www.medline.com/product/Empower-Rollator/Rollators/Z05-PF75510?question=rollator&index=P11&indexCount=11>.
 “Guardian Deluxe Rollators with 8" Wheels”, Medline product currently available at <https://www.medline.com/product/Guardian-Deluxe-Rollators-with-8-Wheels/Rollators/Z05-PF04840?question=rollator&index=P1&indexCount=1#mrkSpec>.
 “Guardian Economy Rollators”, Medline product currently available at <https://www.medline.com/product/Guardian-Economy-Rollators/Rollators/Z05-PF04841?question=rollator&index=P9&indexCount=9>.
 “Invacare® Rollite™ Rollator by Patterson Medical”, Medline product currently available at <https://www.medline.com/product/Invacare-Rollite153-Rollator-by-Patterson-Medical/Rollators/Z05-PF59721?question=rollator&index=P37&indexCount=37>.
 “Light Weight Extra Wide Heavy-Duty Alumi”, Medline product currently available at <https://www.medline.com/product/Light-Weight-Extra-Wide-Heavy-Duty-Alumi/Rollators/Z05-PF55515?question=rollator&index=P41&indexCount=41>.
 “Luxe Rollator”, Medline product currently available at <https://www.medline.com/product/Luxe-Rollator/Rollators/Z05-PF04842?question=rollator&index=P7&indexCount=7>.
 “Posh Pink Zebra Rollator”, Medline product currently available at <https://www.medline.com/product/Posh-Pink-Zebra-Rollator/Rollators/Z05-PF70685?question=rollator&index=P21&indexCount=21>.
 “Rollators with 8" Wheels”, Medline product currently available at <https://www.medline.com/product/Rollators-with-8-Wheels/Rollators/Z05-PF04844?question=rollator&index=P2&indexCount=2>.
 “Set n’ Go Height Adjustable Rollator by Graham-Field”, Medline product currently available at <https://www.medline.com/product/Set-n-Go-Height-Adjustable-Rollator-by-Graham-Field/Rollators/Z05-PF110256?question=rollator&index=P29&indexCount=29>.
 “Simplicity Rollator”, Medline product currently available at <https://www.medline.com/product/Simplicity-Rollator/Rollators/Z05-PF71394?question=rollator&index=P12&indexCount=12c>.
 “Standard Bariatric Heavy Duty Rollator”, Medline product currently available at <https://www.medline.com/product/Standard-Bariatric-Heavy-Duty-Rollator/Rollators/Z05-PF04829?question=rollator&index=P3&indexCount=3>.

(56)

References Cited

OTHER PUBLICATIONS

“Stealth Rollator”, Medline product currently available at <https://www.medline.com/product/Stealth-Rollator/Rollators/Z05-PF71395?question=rollator&index=P19&indexCount=19>.

“Tri-Wheeled Rollators”, Medline product currently available at <https://www.medline.com/product/Tri-Wheeled-Rollators/Rollators/Z05-PF04845?question=rollator&index=P16&indexCount=16>.

“U-Step Walking Stabilizer by Alimed”, Medline product currently available at <https://www.medline.com/product/U-Step-Walking-Stabilizer-by-Alimed/Rollators/Z05-PF57847?question=rollator&index=P48&indexCount=48>.

“Ultralight Rollators”, Medline product currently available at <https://www.medline.com/product/Ultralight-Rollators/Rollators/Z05-PF04838?question=rollator&index=P5&indexCount=5>.

“Walker CarryOn! Bags by Patterson”, Medline product currently available at <https://www.medline.com/product/Walker-CarryOn-Bags-by-Patterson-Medical/Parts-Accessories/Z05-PF58535?P19&indexCount=19>.

“Width Adjustable Rollators”, Medline product currently available at <https://www.medline.com/product/Width-Adjustable-Rollators/Rollators/Z05-PF103010?question=rollator&index=P18&indexCount=18>.

“Winnie Mimi Lite-RollatorTransport Cha”, Medline product currently available at <https://www.medline.com/product/Winnie-Mimi-Lite-Rollator-Transport-Cha/Rollators/Z05-PF43257?question=rollator&index=P53&indexCount=53>.

Chinese Office Action from Chinese Patent Application No. 2013105474061.7 dated Sep. 2, 2016 with English translation.

Copenheaver, Blaine R.; Authorized Officer; International Search Report and Written Opinion from related International Application No. PCT/US2016/026936; Jul. 6, 2016; 14 pages.

PCT Patent Application No. PCT/US2013/068116; International Search Report and Written Opinion Dated Feb. 13, 2014.

Taiwanese Search Report from TW102303182 Dated Jul. 17, 2014.

* cited by examiner

FIG. 1



FIG. 2

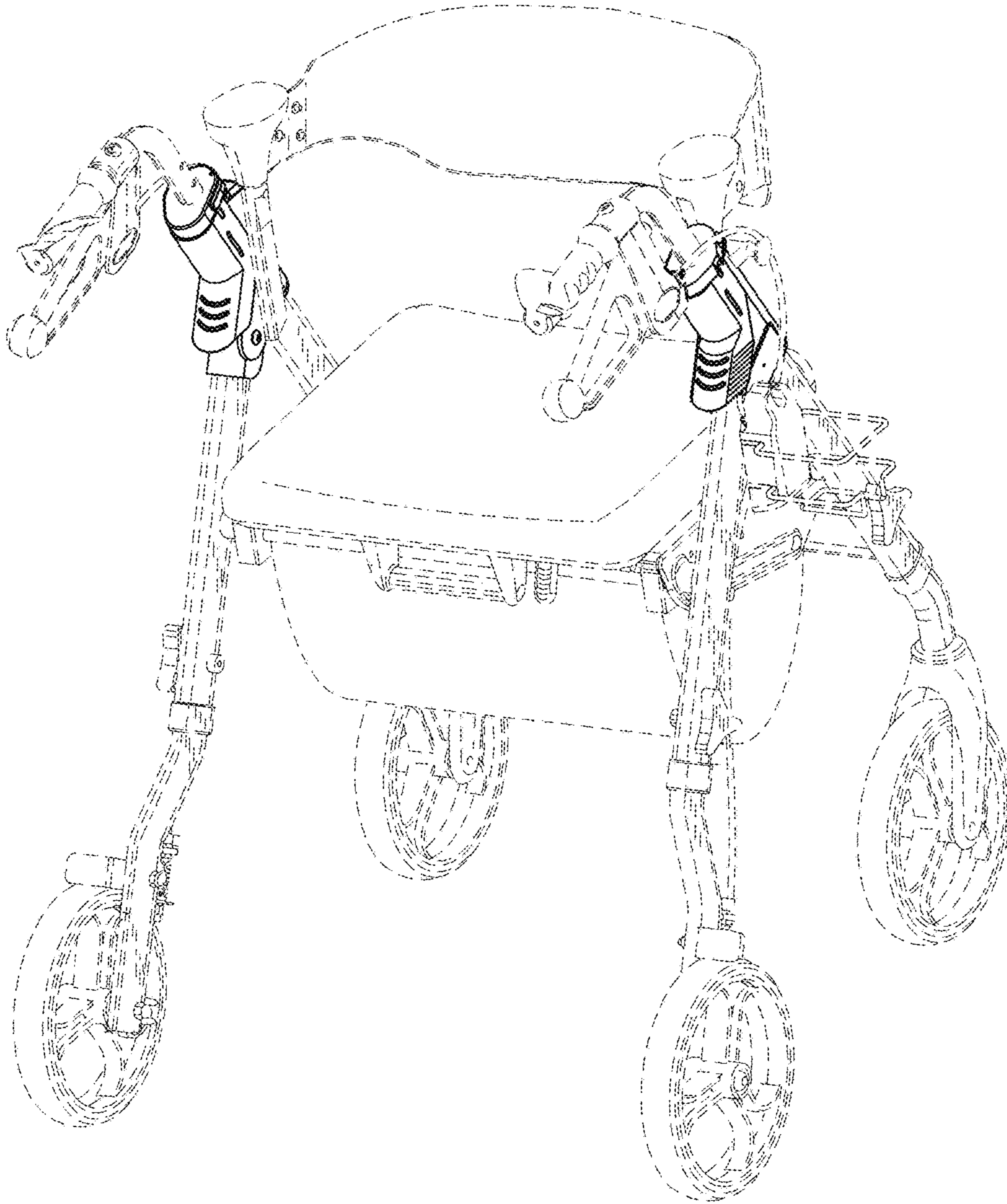

FIG. 3

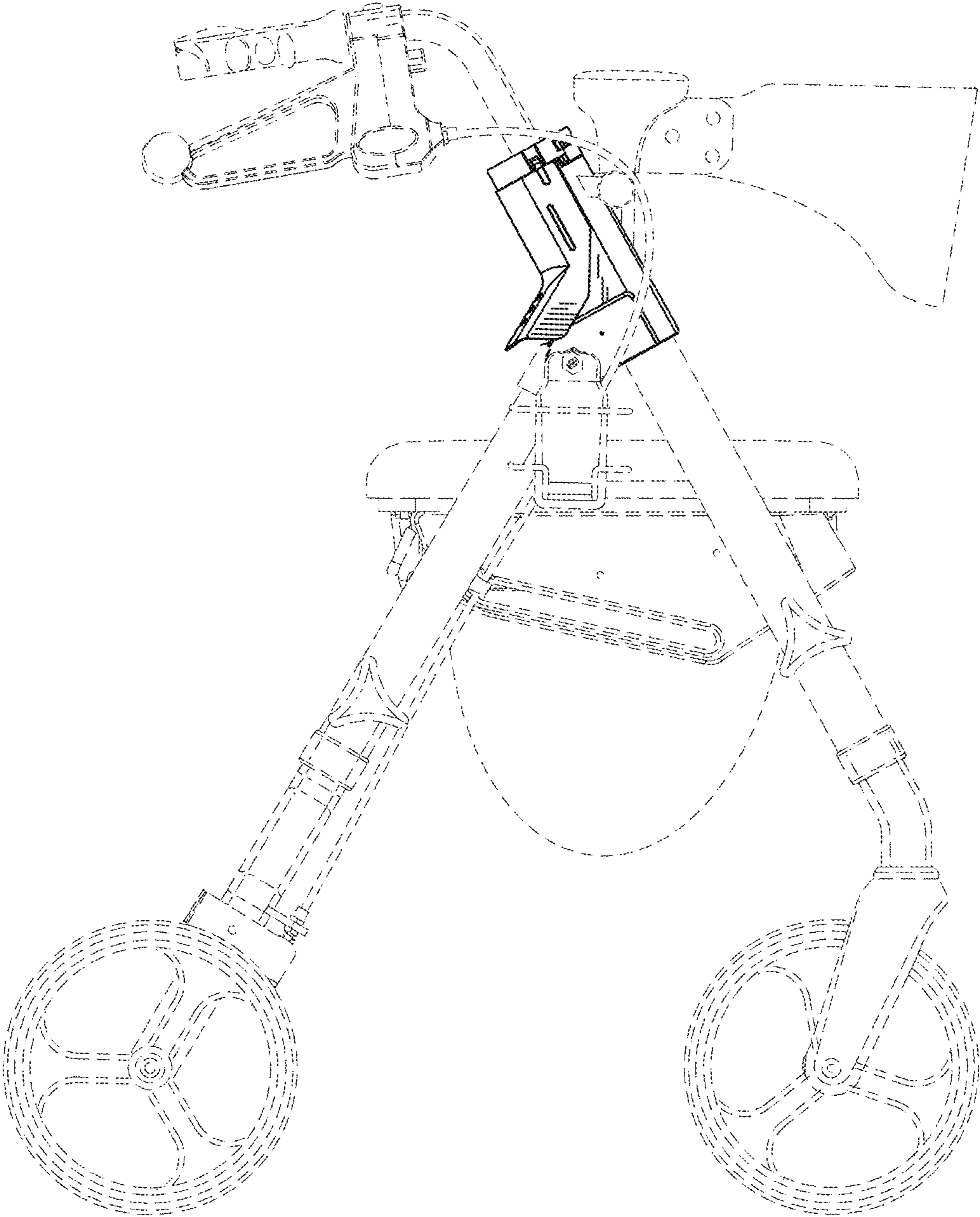

FIG. 4

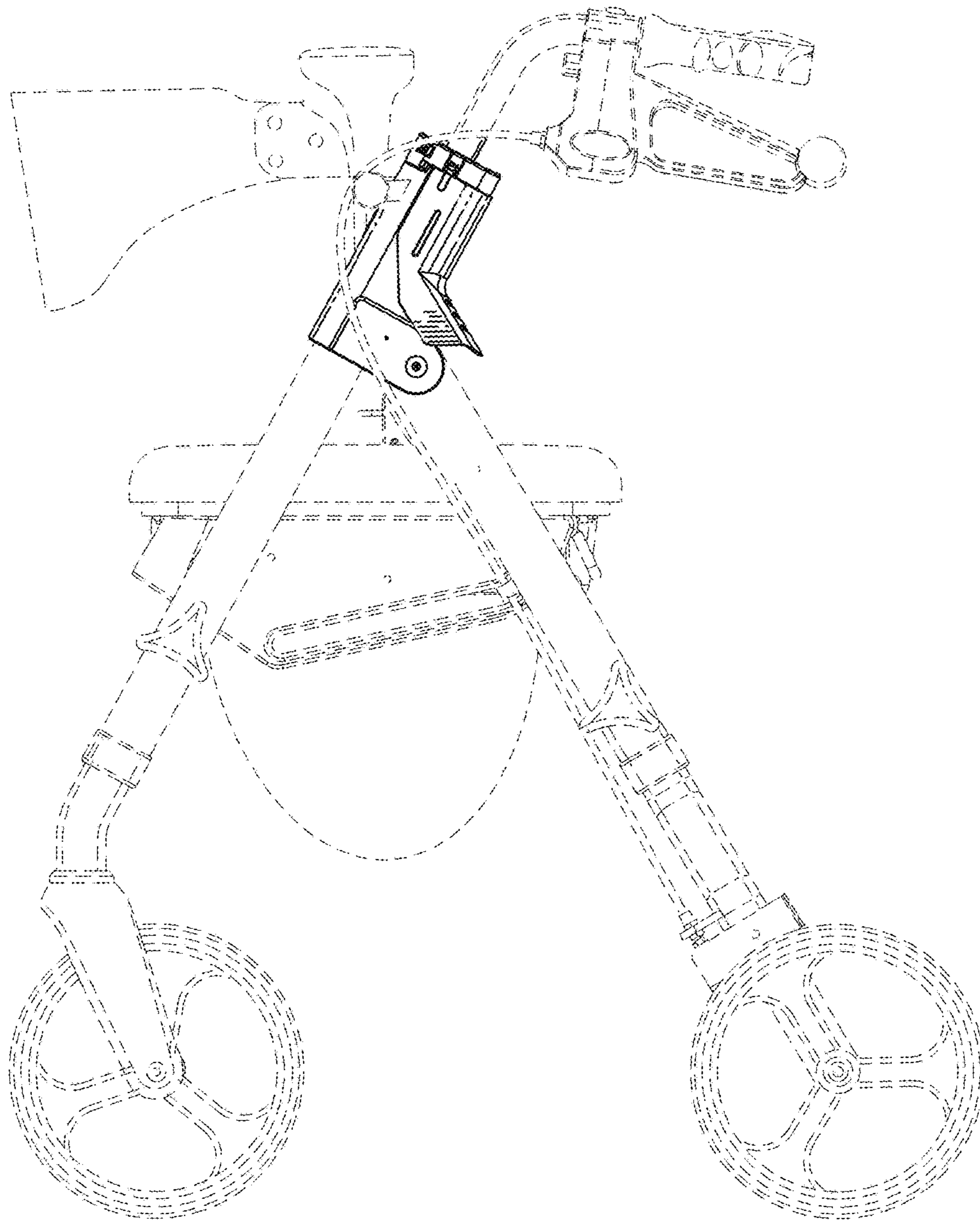

FIG. 5

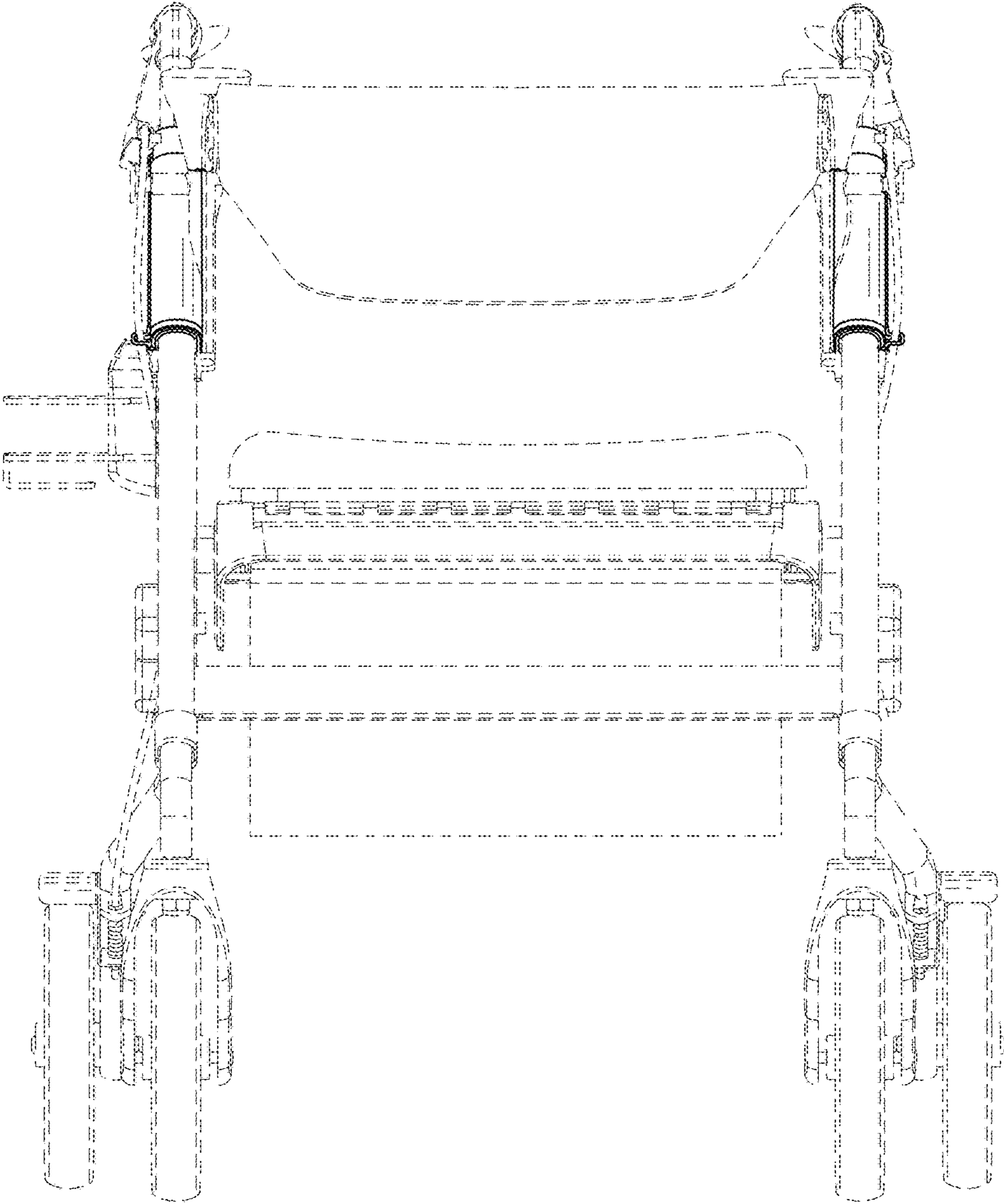

FIG. 6

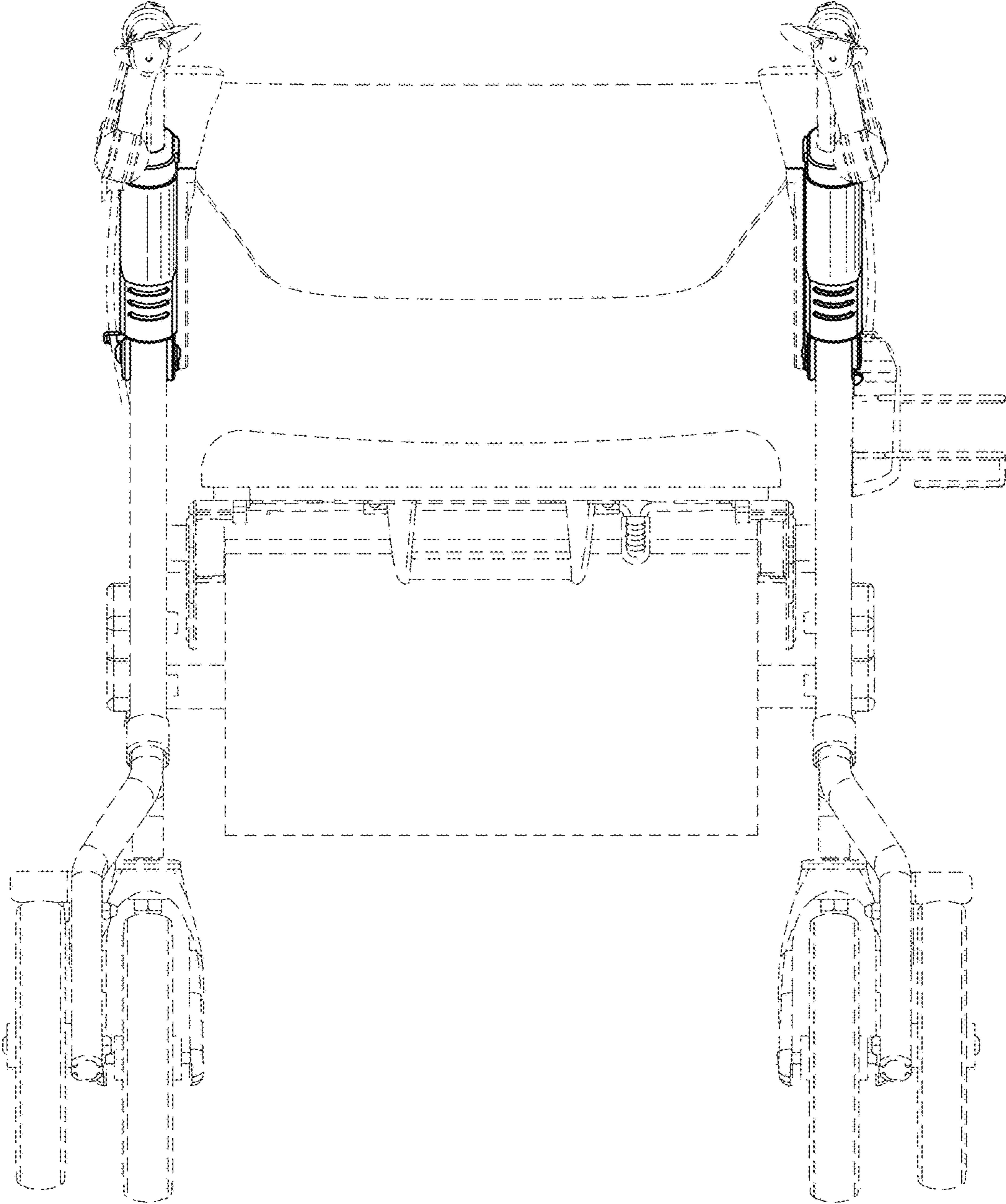

FIG. 7

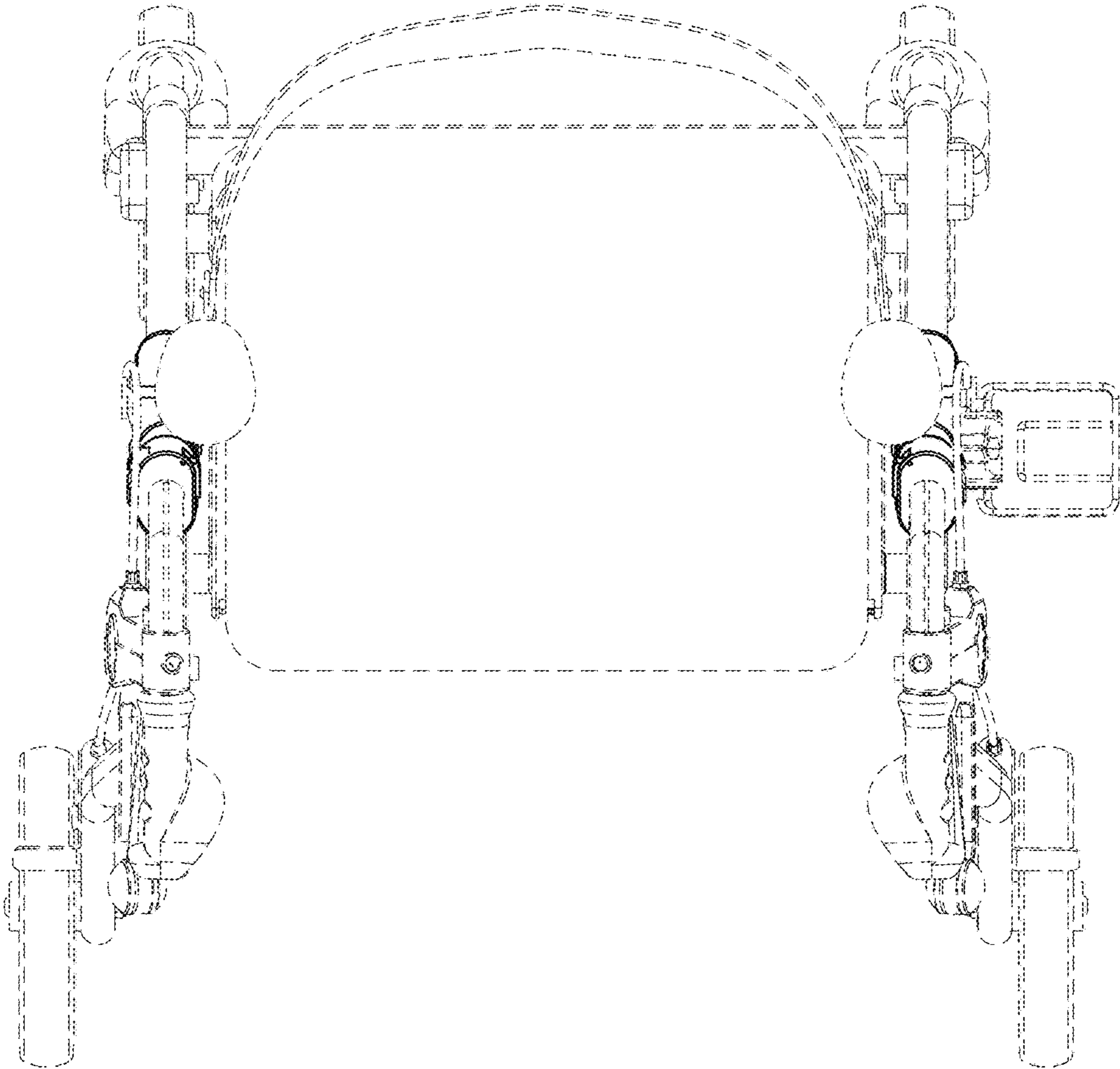

FIG. 8

