

US00D795693S

(12) **United States Design Patent** (10) **Patent No.:** **US D795,693 S**
Zabeleta et al. (45) **Date of Patent:** **** Aug. 29, 2017**

(54) **AXIALLY ORIENTED PERIPHERAL
SIDEWALLED BEVERAGE CONTAINER LID**

D7/509, 510, 511; D3/202, 203.2, 247,
D3/294, 304, 318; D28/91.1; D8/343,
D8/346, 352, 382, 397, 399

(71) Applicants: **Daniel A Zabeleta**, Cooper City, FL
(US); **Sam D Hackett**, Fort Lauderdale,
FL (US); **Joseph D Bulso**, Canton, OH
(US); **Daniel Edward Livezey**,
Feasterville, PA (US); **William Allen
Hibbs, Jr.**, Bolivar, OH (US)

CPC .. A61J 1/00; A61J 1/1412; B65D 1/00; B65D
1/02; B65D 1/10; B65D 1/46; B65D
2585/56; B65D 41/00; B65D 41/56;
B65D 41/62; B65D 47/06; B65D 47/08;
B65D 2543/00046; B65D 2543/00092;
B65D 2543/00296

See application file for complete search history.

(72) Inventors: **Daniel A Zabeleta**, Cooper City, FL
(US); **Sam D Hackett**, Fort Lauderdale,
FL (US); **Joseph D Bulso**, Canton, OH
(US); **Daniel Edward Livezey**,
Feasterville, PA (US); **William Allen
Hibbs, Jr.**, Bolivar, OH (US)

(56)

References Cited

U.S. PATENT DOCUMENTS

2,004,964 A	6/1935	Behr et al.
2,112,231 A	3/1938	Speidel et al.
2,303,205 A	11/1942	Frankenberg
2,384,810 A	9/1945	Calleson
2,409,788 A	10/1946	Osborne
2,426,550 A	8/1947	Coyle
2,602,565 A	7/1952	Regan
3,029,507 A	4/1962	Gaggini
3,176,872 A	4/1965	Zundel
3,191,564 A	6/1965	Fraze
3,225,957 A	12/1965	Huth
3,255,917 A	6/1966	Fraze
3,303,960 A	2/1967	Fraze
3,349,949 A	10/1967	Brown
3,361,291 A	1/1968	Fraze
3,439,640 A	4/1969	Fraze
3,439,833 A	4/1969	Fraze
3,446,389 A	5/1969	Brown
3,480,175 A	11/1969	Khoury
3,638,597 A	2/1972	Brown
3,643,833 A	2/1972	Fraze et al.
3,726,432 A	4/1973	Gentile
3,752,353 A	8/1973	Slade
3,795,342 A	3/1974	Ashton
3,844,443 A	10/1974	Cudzik
3,856,184 A	12/1974	Luviano
3,871,314 A	3/1975	Stargell
3,877,604 A	4/1975	Brown
3,880,318 A	4/1975	Fraze
3,910,453 A	10/1975	Kneusel
3,924,777 A	12/1975	Peysen
3,938,693 A	2/1976	Patel et al.
3,952,911 A	4/1976	Bozek et al.
3,967,752 A	7/1976	Cudzik
4,007,848 A	2/1977	Snyder
4,042,144 A	8/1977	Henning

(**) Term: **15 Years**

(21) Appl. No.: **29/560,269**

(22) Filed: **Apr. 5, 2016**

Related U.S. Application Data

(60) Continuation-in-part of application No. 29/491,268,
filed on May 19, 2014, now Pat. No. Des. 752,978,
and a continuation-in-part of application No.
15/056,216, filed on Feb. 29, 2016, which is a
continuation-in-part of application No. 14/665,102,
filed on Mar. 23, 2015, now Pat. No. 9,272,819,
which is a division of application No. 13/787,012,
filed on Mar. 6, 2013, now Pat. No. 8,985,371, which
is a continuation-in-part of application No.
13/572,404, filed on Aug. 10, 2012, now Pat. No.
8,844,761.

(51) **LOC (10) Cl.** **09-07**

(52) **U.S. Cl.**
USPC **D9/435**

(58) **Field of Classification Search**
USPC D9/415, 434, 435, 440, 446-450, 452,
D9/453, 454, 455-457, 499; D7/387,
D7/388, 396.2, 396.4, 396.6, 398, 403,

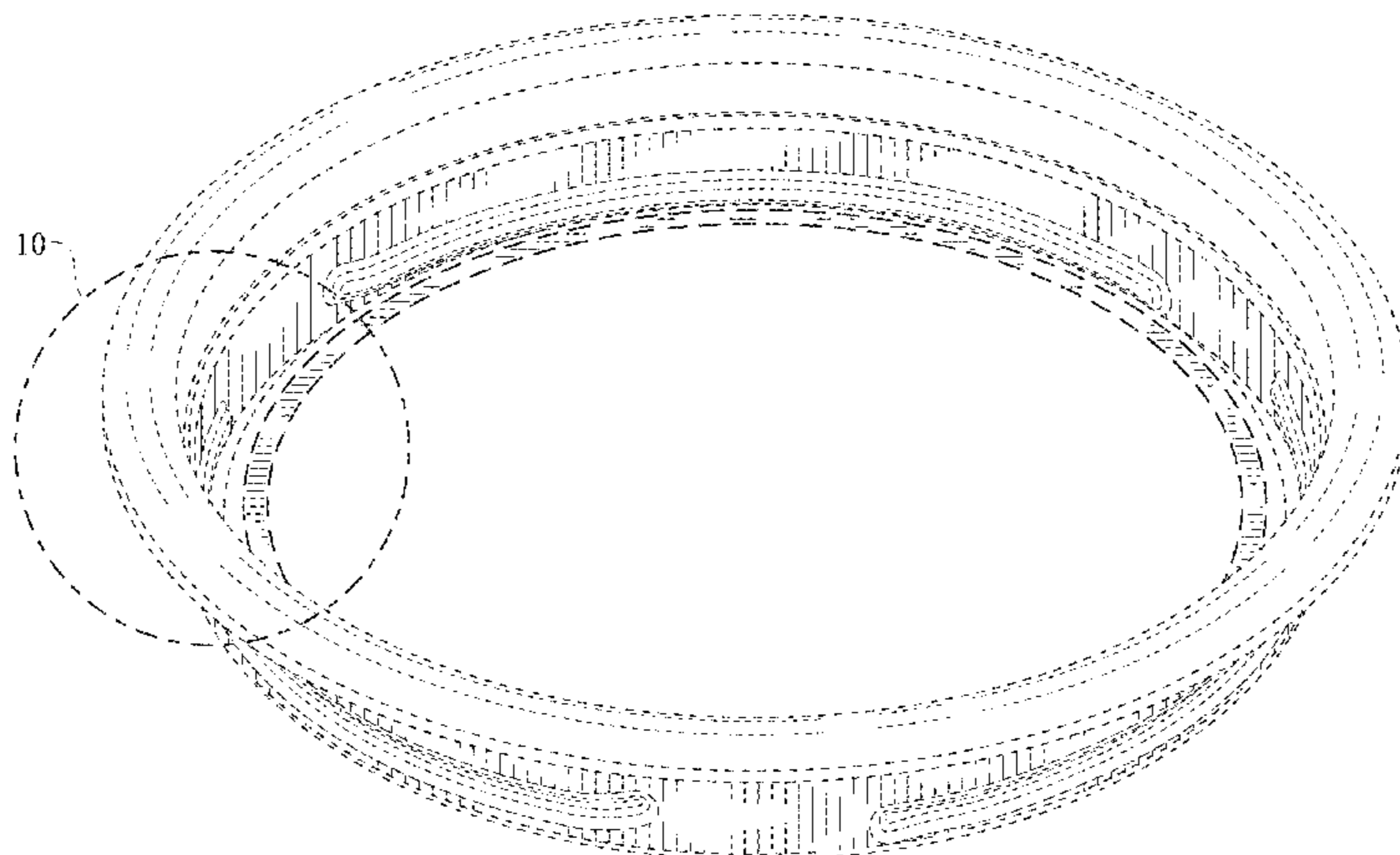

US D795,693 S

4,065,025 A	12/1977	Potts	D525,127 S *	7/2006	Cogley	D9/456
4,078,695 A	3/1978	Potts	D559,680 S	1/2008	Jacober et al.	
4,116,360 A	9/1978	McKernan et al.	7,500,577 B2	3/2009	Wichelhaus	
4,116,361 A	9/1978	Stargell	7,743,635 B2	6/2010	Jentzsch	
4,122,971 A	10/1978	Potts	7,823,740 B2	11/2010	Perra	
4,172,532 A	10/1979	Palsson	7,841,222 B2	11/2010	Cook et al.	
4,182,460 A	1/1980	Holk	7,891,517 B2	2/2011	Simmons	
4,262,815 A	4/1981	Klein	7,918,359 B2	4/2011	Paris et al.	
4,286,728 A	9/1981	Fraze et al.	7,918,363 B2	4/2011	Morabito et al.	
4,386,713 A	6/1983	Baumeyer	D641,622 S *	7/2011	Fields	D7/387
4,399,925 A	8/1983	Fundom	D647,400 S *	10/2011	Fields	D7/392.1
D273,846 S	5/1984	Fraze	8,215,513 B1	7/2012	Grissom	
4,476,987 A	10/1984	Nolan	8,328,041 B2	12/2012	Brifcani	
D277,826 S *	3/1985	Brown, Sr.	8,336,726 B2	12/2012	Ramsey et al.	
4,567,746 A	2/1986	Fraze et al.	8,336,728 B2	12/2012	Forrest	
4,574,975 A	3/1986	Cudzik et al.	D681,176 S *	4/2013	Chacko	D23/269
4,685,849 A	8/1987	LaBarge et al.	8,534,490 B2	9/2013	Chapin	
4,705,186 A	11/1987	Barrash	8,556,106 B1	10/2013	Bayat et al.	
4,711,611 A	12/1987	Fraze	D696,113 S *	12/2013	Stein	D9/447
4,723,687 A	2/1988	Kutterer	8,608,007 B2	12/2013	Seo	
4,793,510 A	12/1988	Arfert et al.	8,720,717 B2	5/2014	Kaanta et al.	
4,821,912 A	4/1989	Wells	D706,908 S *	6/2014	Knapp	D23/269
RE32,927 E	5/1989	Taylor	8,939,311 B2	1/2015	Christopoulos et al.	
4,865,215 A	9/1989	Wells	D728,757 S *	5/2015	Graham	D23/269
4,872,597 A	10/1989	Hanafusa	D730,734 S *	6/2015	Rapparini	D9/454
4,928,844 A	5/1990	La Barge	9,145,239 B2 *	9/2015	Wohlgenannt	B65D 5/748
4,982,862 A	1/1991	La Barge	9,162,796 B2 *	10/2015	Bratsch	B65D 17/166
5,052,576 A	10/1991	Budenbender	2001/0040167 A1	11/2001	Flecheux et al.	
5,121,851 A	6/1992	Lyon et al.	2002/0030053 A1	3/2002	Copeland	
D337,521 S *	7/1993	McNulty	2003/0116521 A1	6/2003	Chupak	
D338,621 S *	8/1993	Balson	2003/0213709 A1	11/2003	Gibler et al.	
5,248,053 A	9/1993	Lundgren	2003/0213803 A1	11/2003	Chasteen	
5,292,025 A	3/1994	Dubreul	2004/0159662 A1	8/2004	Johnson	
5,293,765 A	3/1994	Nussbaum	2004/0256386 A1	12/2004	LaFortune	
D348,137 S *	6/1994	Campbell	2005/0029264 A1	2/2005	Werth	
5,356,030 A	10/1994	Budenbender	2005/0115969 A1	6/2005	Mizuma	
D355,735 S *	2/1995	Shaffer	2005/0127077 A1	6/2005	Chupak	
5,421,480 A	6/1995	Cudzik	2005/0150889 A1	7/2005	Perra	
5,443,175 A	8/1995	Kelly et al.	2007/0045318 A1	3/2007	Gibson et al.	
5,511,920 A	4/1996	Artrip	2007/0170184 A1 *	7/2007	Canedo	A45F 3/18 220/254.9
D387,987 S	12/1997	Neiner				
5,692,633 A	12/1997	Gordon	2008/0053997 A1	3/2008	Perra	
5,711,447 A	1/1998	Plester	2008/0099480 A1	5/2008	Chang	
5,713,235 A	2/1998	Diekhoff	2008/0110922 A1	5/2008	Sines	
5,718,352 A	2/1998	Diekhoff	2008/0237235 A1	10/2008	Morabito	
5,778,723 A	7/1998	Diekhoff	2009/0026201 A1	1/2009	Hall et al.	
5,779,086 A	7/1998	Barrash	2009/0045158 A1	2/2009	Suriol	
5,785,198 A	7/1998	Credle	2009/0200306 A1	8/2009	Breunig	
D397,062 S *	8/1998	Hollington	2009/0261101 A1	10/2009	Forrest	
5,799,775 A	9/1998	Spring	2010/0126992 A1	5/2010	Phillips	
5,816,428 A	10/1998	Plester	2010/0133275 A1	6/2010	Phillips	
5,822,843 A	10/1998	Diekhoff	2010/0294768 A1	11/2010	Ramsey et al.	
5,947,318 A	9/1999	Palm	2010/0320207 A1	12/2010	Sjogren et al.	
5,975,322 A	11/1999	Reid	2011/0036839 A1	2/2011	Gardner	
6,010,026 A	1/2000	Jordan et al.	2011/0036840 A1	2/2011	Zakai	
6,010,028 A	1/2000	Jordan et al.	2011/0056945 A1 *	3/2011	Ramsey	B65D 17/24 220/269
6,082,944 A	7/2000	Bachmann				
6,105,807 A	8/2000	McCrosen				
D434,983 S *	12/2000	Hurst	2011/0062106 A1	3/2011	Akveld	
6,206,222 B1	3/2001	Cudzik	2011/0100946 A1	5/2011	Perra	
6,216,904 B1	4/2001	Cagan	2011/0168709 A1	7/2011	Wells	
6,234,338 B1	5/2001	Searle	2011/0226636 A1	9/2011	Petti	
D452,155 S *	12/2001	Stodd	2011/0232423 A1	9/2011	Raymond	
6,330,954 B1	12/2001	Turner et al.	2012/0012586 A1	1/2012	Rinderer	
6,332,551 B1	12/2001	Copeland	2012/0037631 A1	2/2012	Weist	
6,450,358 B1	9/2002	Berro	2012/0228294 A1	9/2012	Grissom	
6,460,723 B2	10/2002	Nguyen et al.	2012/0273490 A1	11/2012	Jensen	
D470,050 S *	2/2003	Renz	2013/0082055 A1	4/2013	Ramsey et al.	
6,575,325 B2	6/2003	Dickie et al.	2013/0200034 A1	8/2013	Kaanta	
6,609,634 B2	8/2003	De Laforcade et al.	2013/0240527 A1 *	9/2013	Philippe	B44D 3/12 220/270
6,626,314 B1	9/2003	McHenry et al.				
6,651,833 B2	11/2003	Sciarini				
6,739,471 B2	5/2004	Goetz et al.	2014/0042164 A1 *	2/2014	Zabaleta	B65D 41/32 220/267
6,779,677 B2	8/2004	Chupak				
6,877,941 B2	4/2005	Brifeani et al.	2014/0238994 A1	8/2014	Christopoulos et al.	
6,889,862 B2	5/2005	Vaughan	2015/0190003 A1 *	7/2015	Kelahaer	A47G 19/2272 220/303
6,910,598 B2	6/2005	Gotz et al.				
7,014,060 B2	3/2006	Richardson	2016/0016700 A1 *	1/2016	Stevens	B65D 3/30 220/258.5
D518,885 S *	4/2006	Stout, Jr.				

FOREIGN PATENT DOCUMENTS

CA	476789	9/1951
EP	0414249 A2	2/1991
EP	2212215 B1	2/2012
EP	2555988 A1	6/2014
WO	WO2011025327 A2	3/2011
WO	WO2011124552 A1	10/2011

OTHER PUBLICATIONS

Customized Logo 401# Stretch Tin Can Lids for Food and Wine Paper Tube, [curiosexpeditions.org](http://papercanspackaging.sell.curiosexpeditions.org/iz6fge2df-customised-logo-401-stretch-tin-can-lids-for-food-and-wine-paper-tube-images), 2 pages. Found online, Nov. 11, 2015 at <http://papercanspackaging.sell.curiosexpeditions.org/iz6fge2df-customised-logo-401-stretch-tin-can-lids-for-food-and-wine-paper-tube-images>.

Gold Candle Jars Timplat 307# Stretch Metal Can Lids, [curiosexpeditions.org](http://papercanspackaging.sell.curiosexpeditions.org/iz6fge2dc-gold-candle-jars-timplat-307-images), 2 Pages. Found online Nov. 11, 2015 at <http://papercanspackaging.sell.curiosexpeditions.org/iz6fge2dc-gold-candle-jars-timplat-307-images>.

* cited by examiner

Primary Examiner — Karen S Acker

Assistant Examiner — Wendy Arminio

(74) *Attorney, Agent, or Firm* — Allen D. Hertz, P.A.; Allen D. Hertz

(57)

CLAIM

We claim the ornamental design for an axially oriented peripheral sidewalled beverage container lid, as shown and described.

DESCRIPTION

FIG. 1 is an isometric top view of an axially oriented peripheral sidewalled beverage container lid;

FIG. 2 is an isometric bottom view thereof;

FIG. 3 is a top view thereof;

FIG. 4 is a bottom view thereof;

FIG. 5 is a front view thereof;

FIG. 6 is a right side view thereof;

FIG. 7 is a rear view thereof;

FIG. 8 is a left side view thereof;

FIG. 9 is a sectioned elevation left side view thereof, the section being taken in a direction of section line 9--9 of FIG. 3;

FIG. 10 is an enlarged detail view of area 10 circumscribed within FIG. 1;

FIG. 11 is an enlarged detail view of area 11 circumscribed within FIG. 2;

FIG. 12 is an enlarged detail view of area 12 circumscribed within FIG. 3;

FIG. 13 is an enlarged detail view of area 13 circumscribed within FIG. 4;

FIG. 14 is an enlarged detail view of area 14 circumscribed within FIG. 9; and,

FIG. 15 is an enlarged detail view of area 15 circumscribed within FIG. 9.

The dash-dash broken lines and the unshaded areas in between the dash-dash broken lines depict portions of the axially oriented peripheral sidewalled beverage container lid that form no part of the claimed design. The dot-dash-dot broken lines in FIGS. 1-4 and FIGS. 9-15 surrounding the detail areas and views form no part of the claimed design.

1 Claim, 15 Drawing Sheets

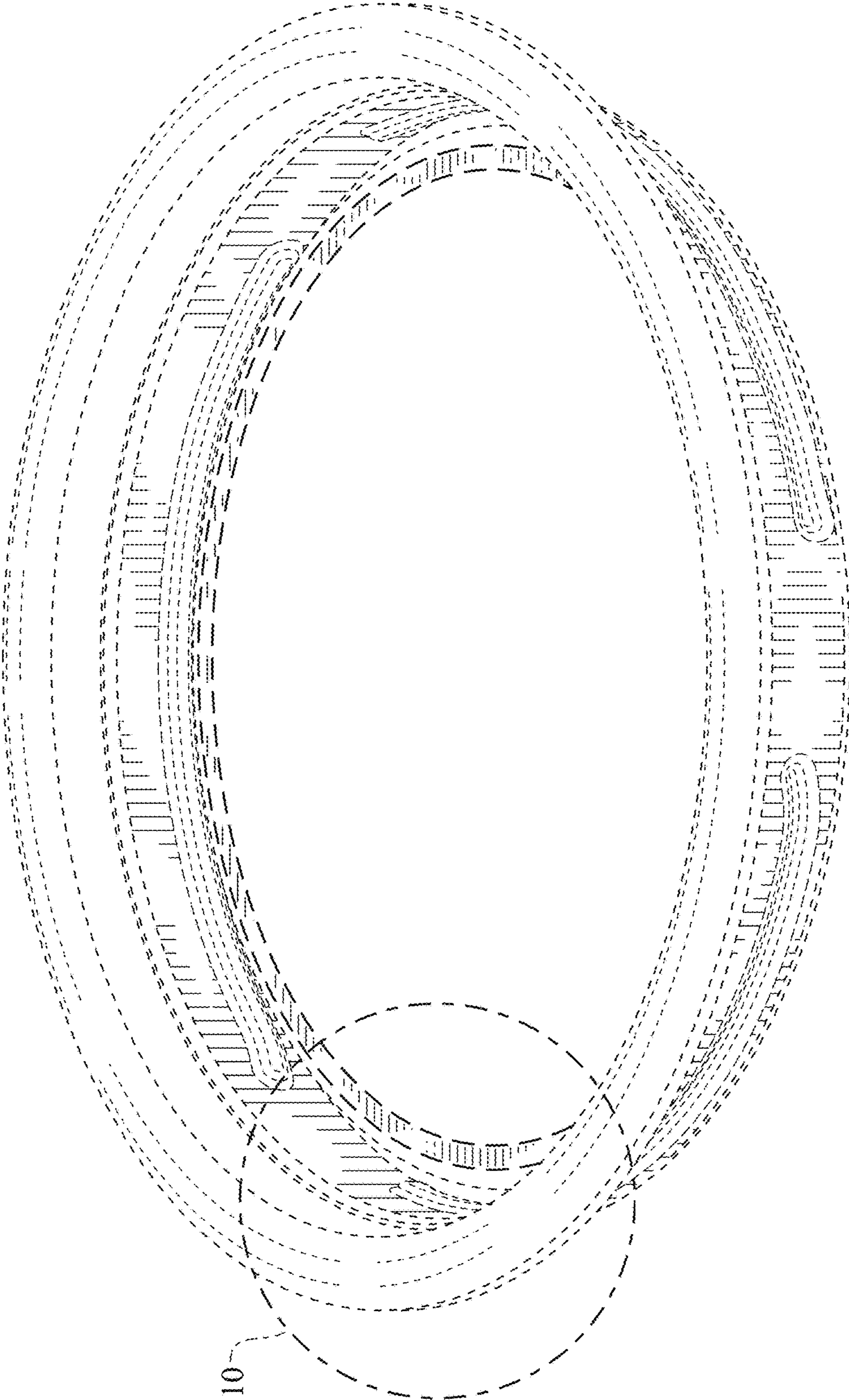

FIG. 1

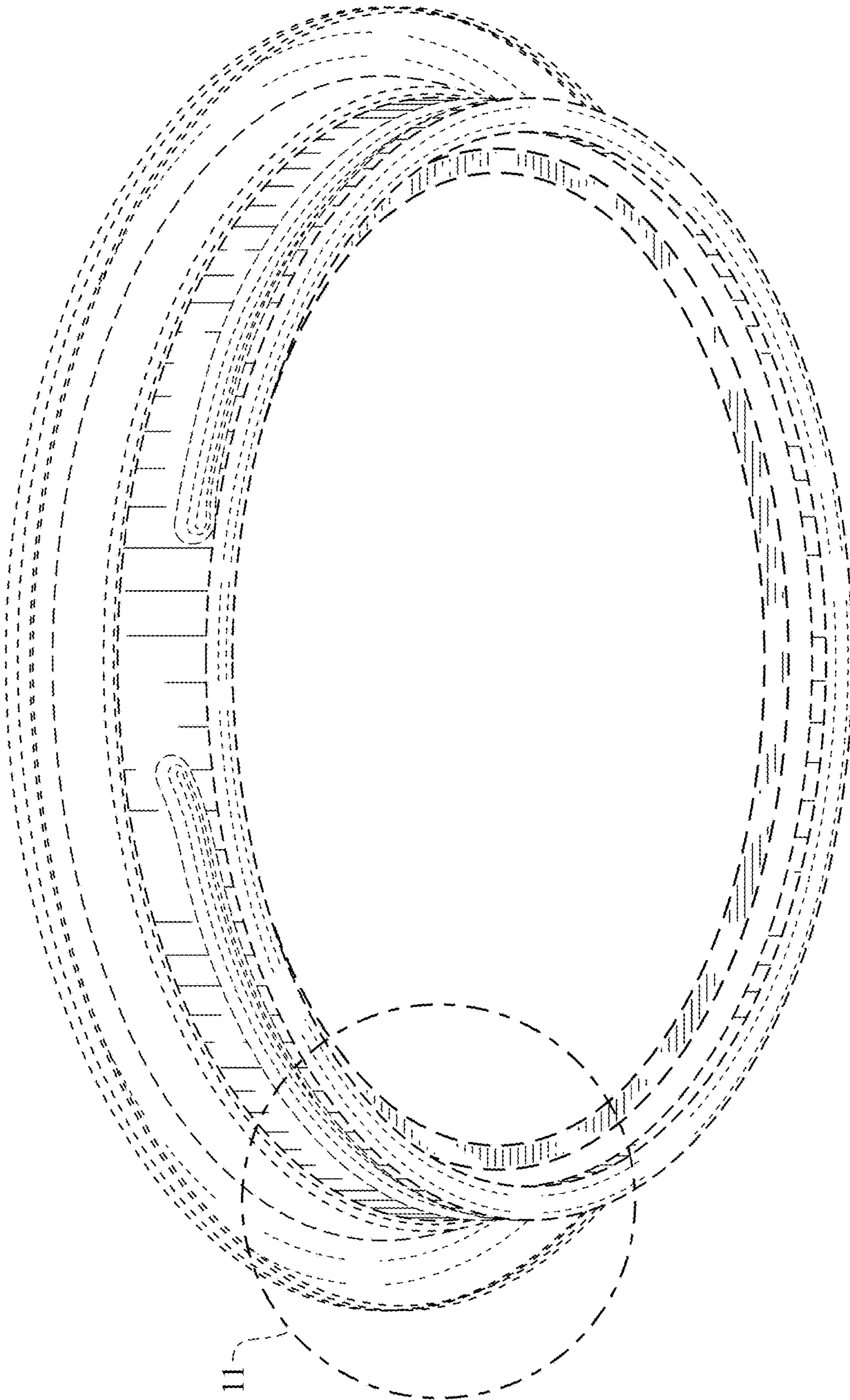

FIG. 2

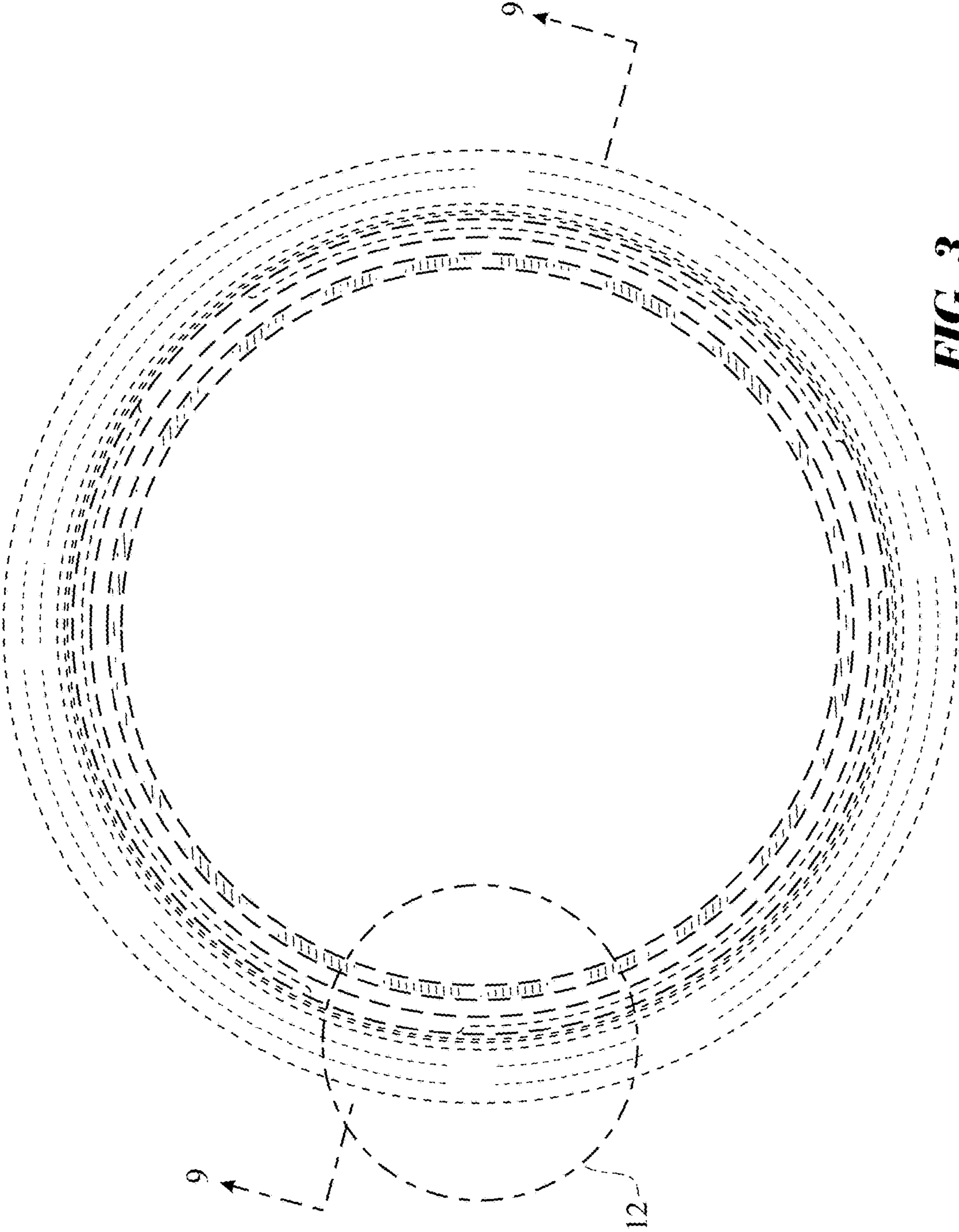

FIG. 3

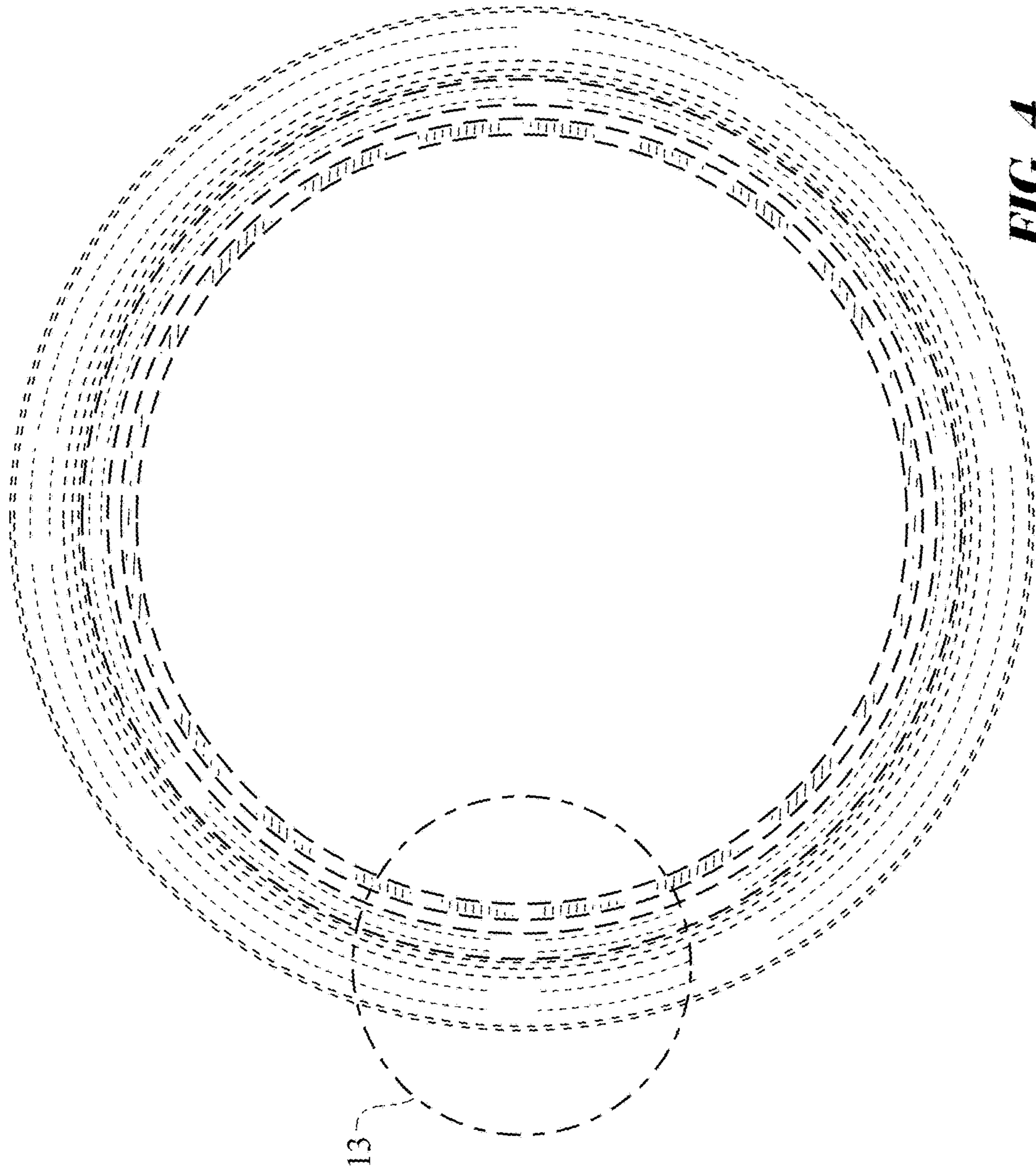

FIG. 4

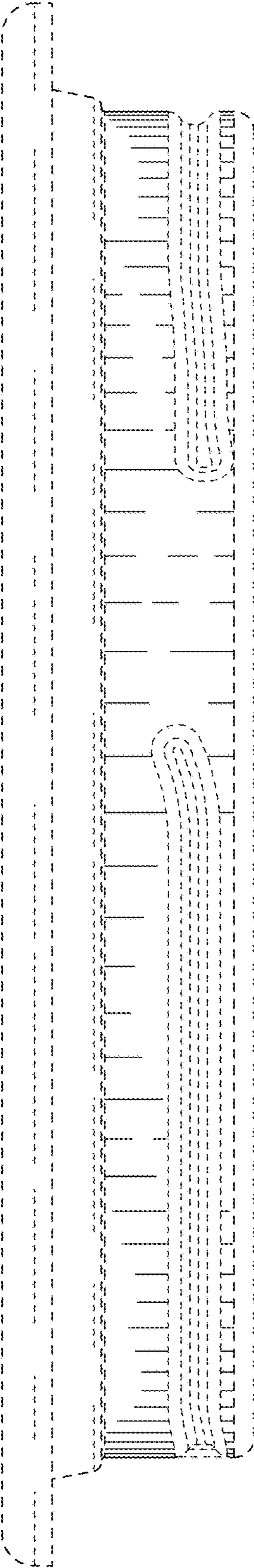

FIG. 5

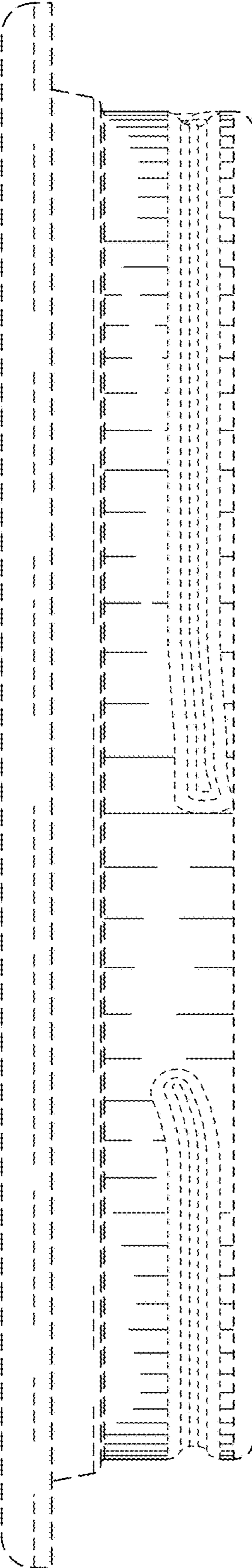

FIG. 6

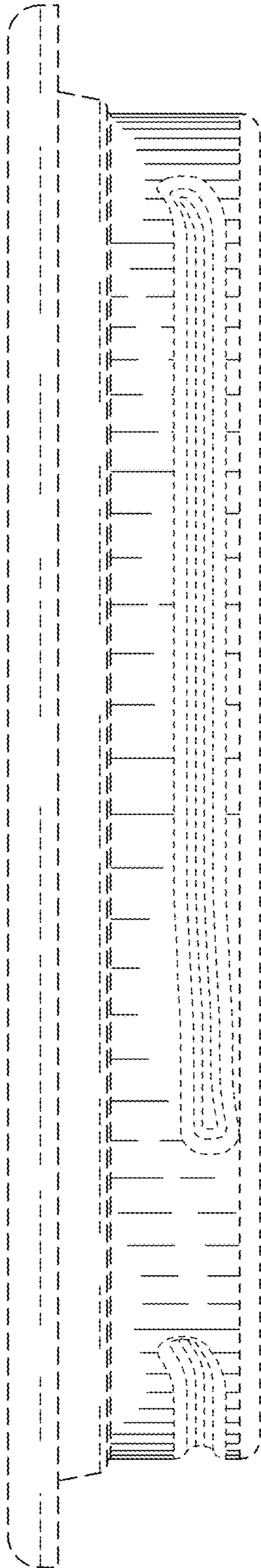

FIG. 7

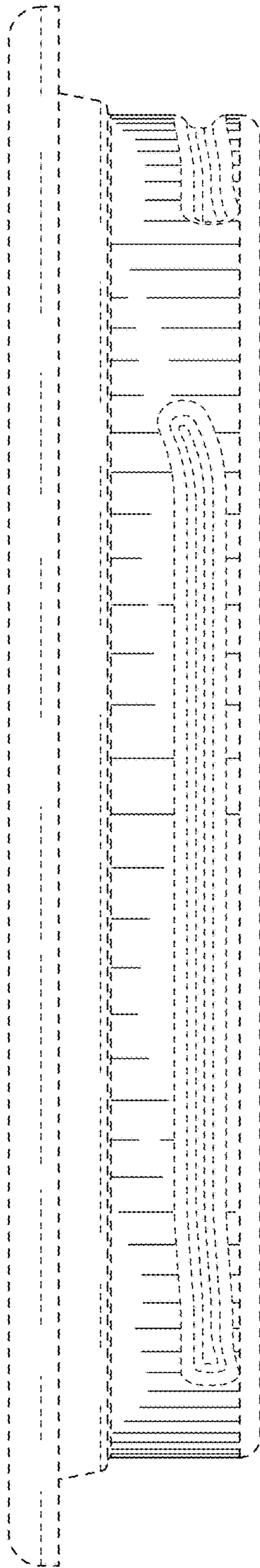

FIG. 8

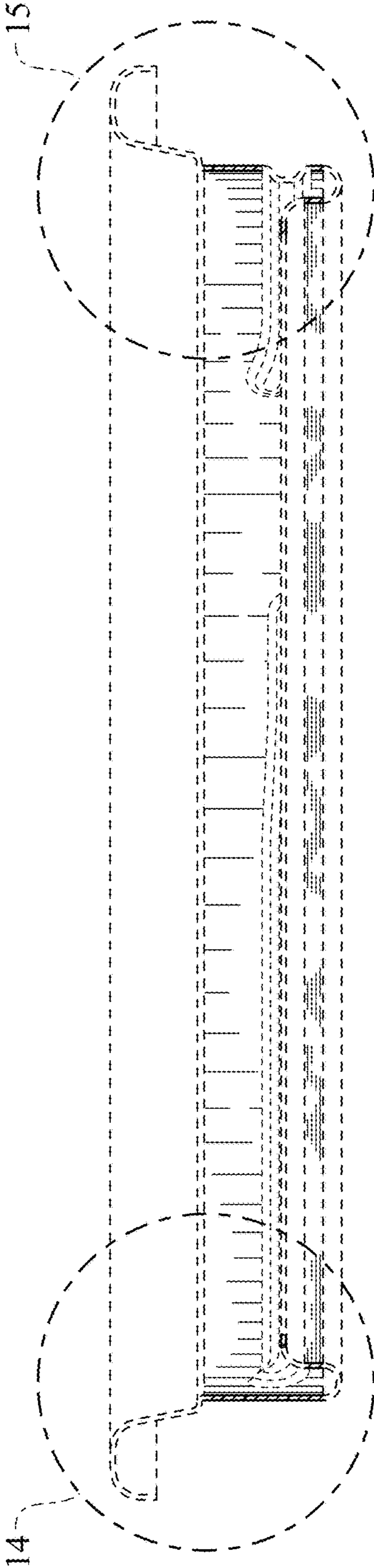

FIG. 9

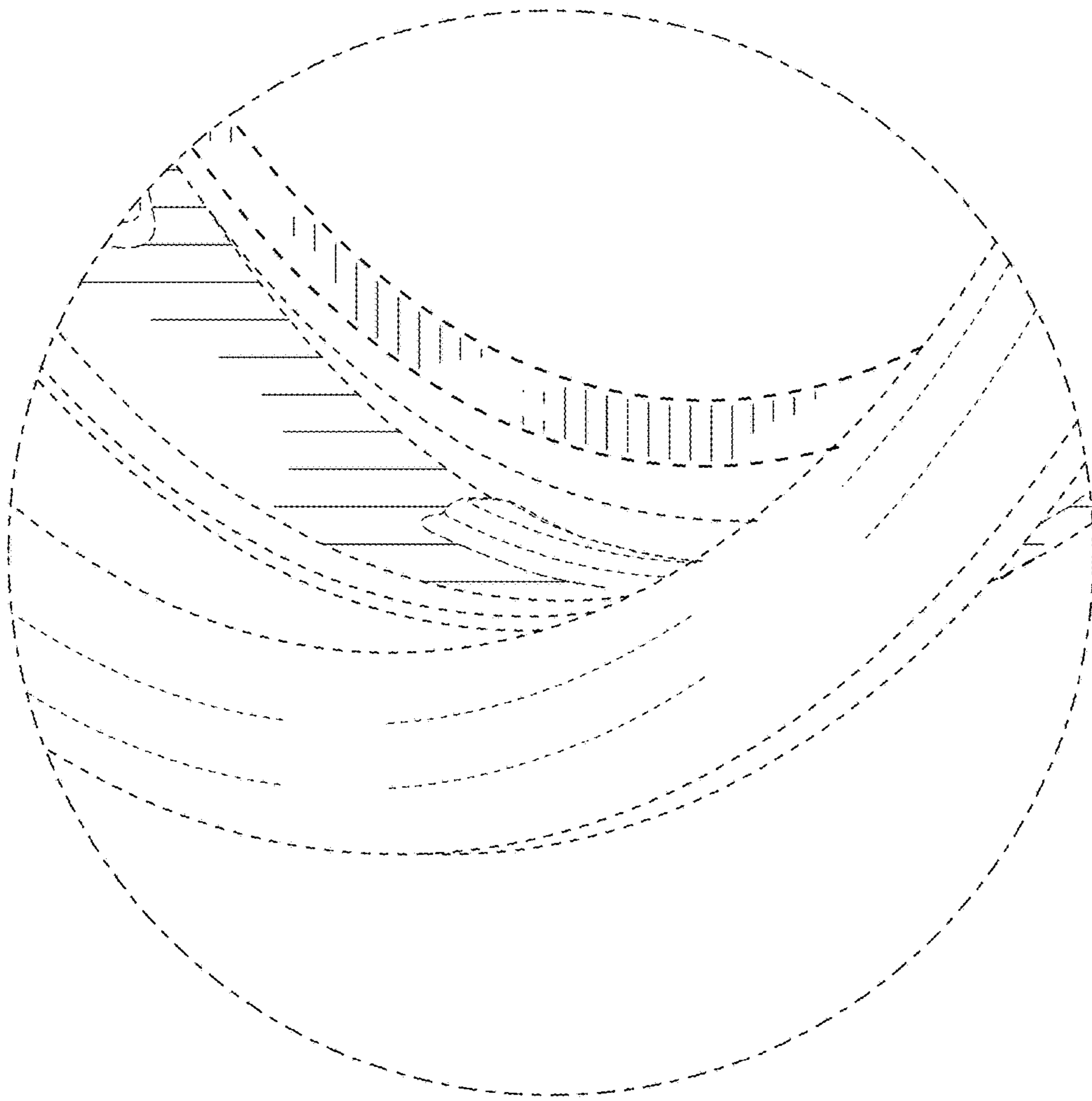

FIG. 10

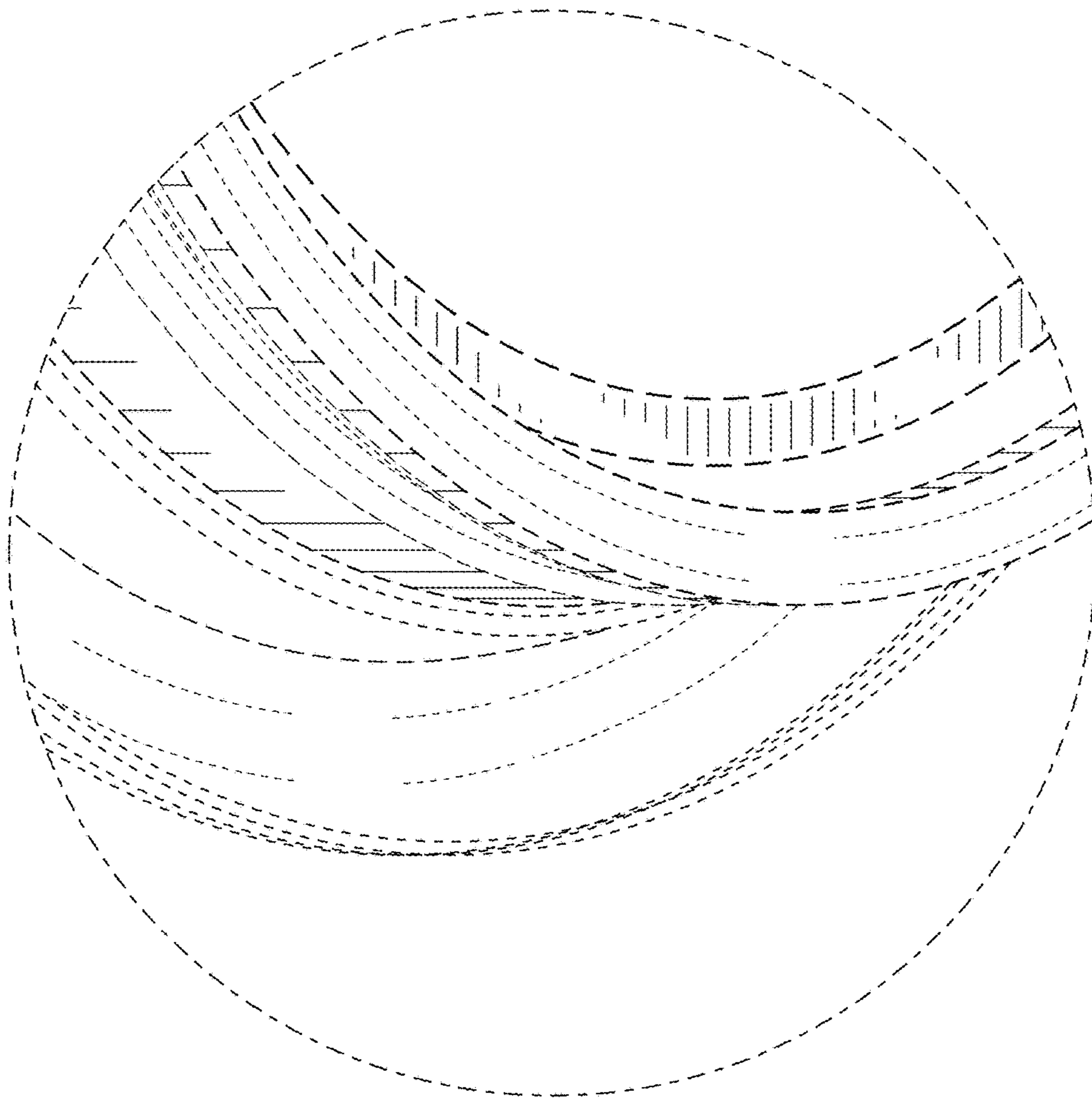

FIG. 11

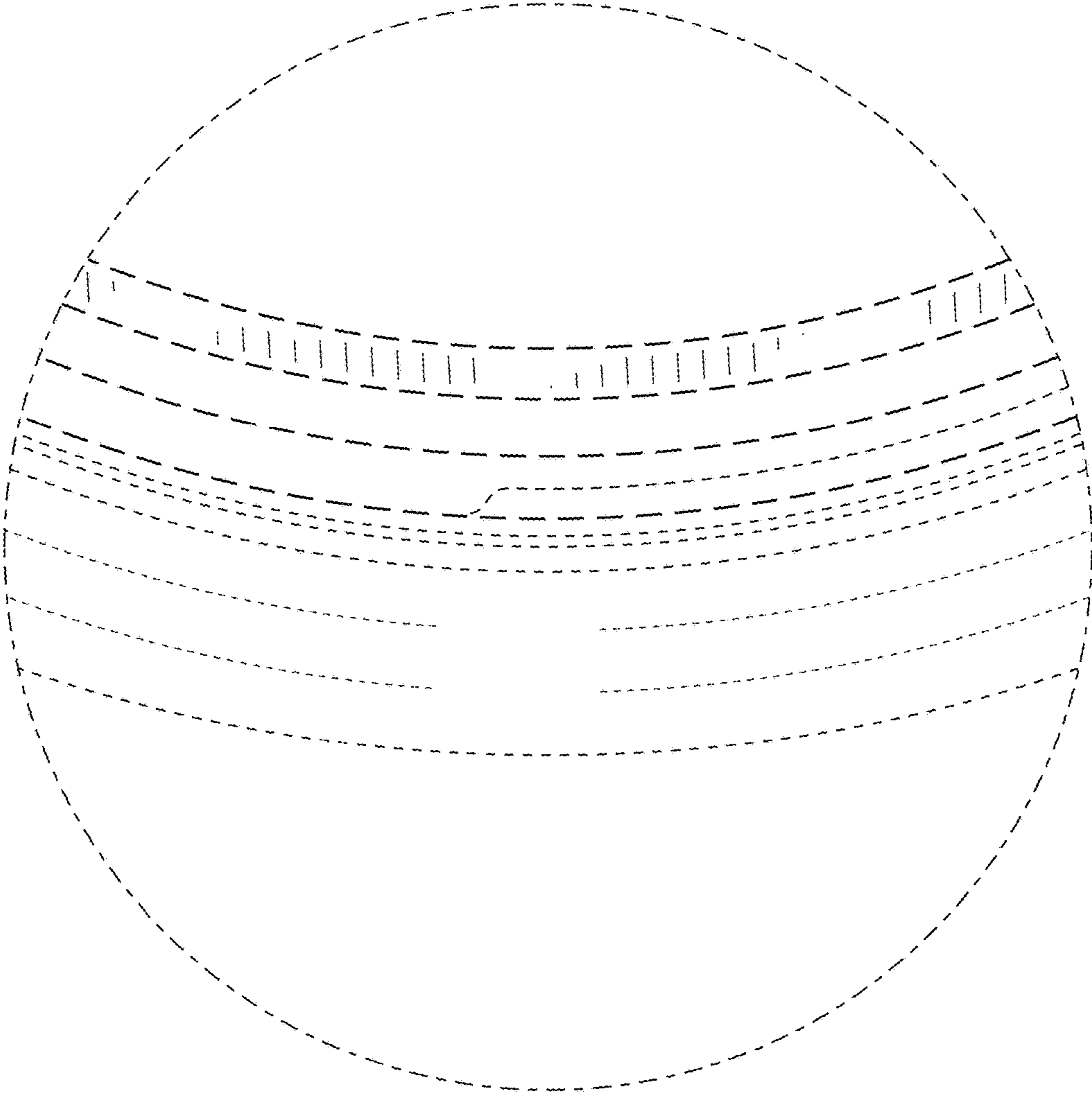

FIG. 12

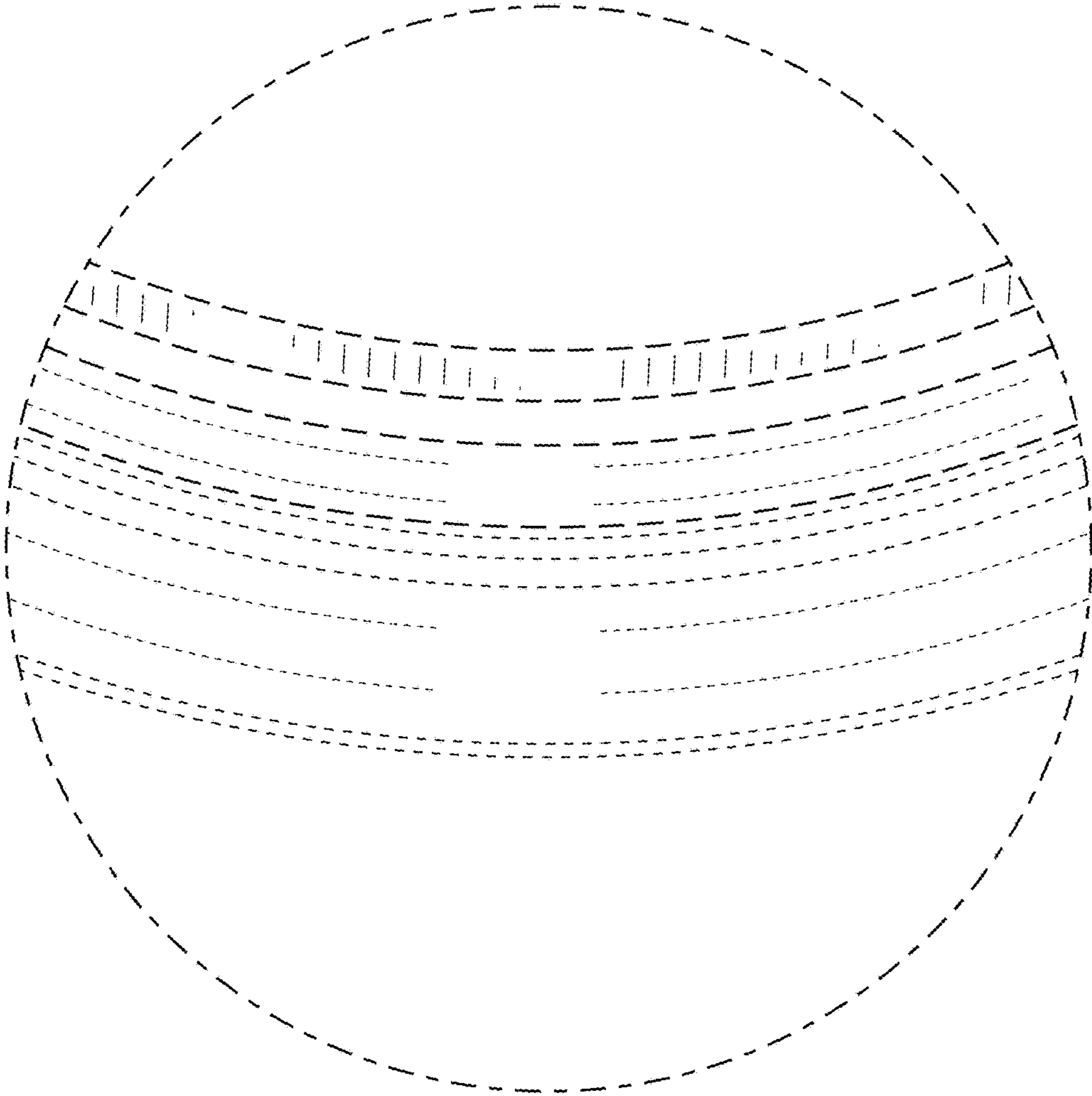

FIG. 13

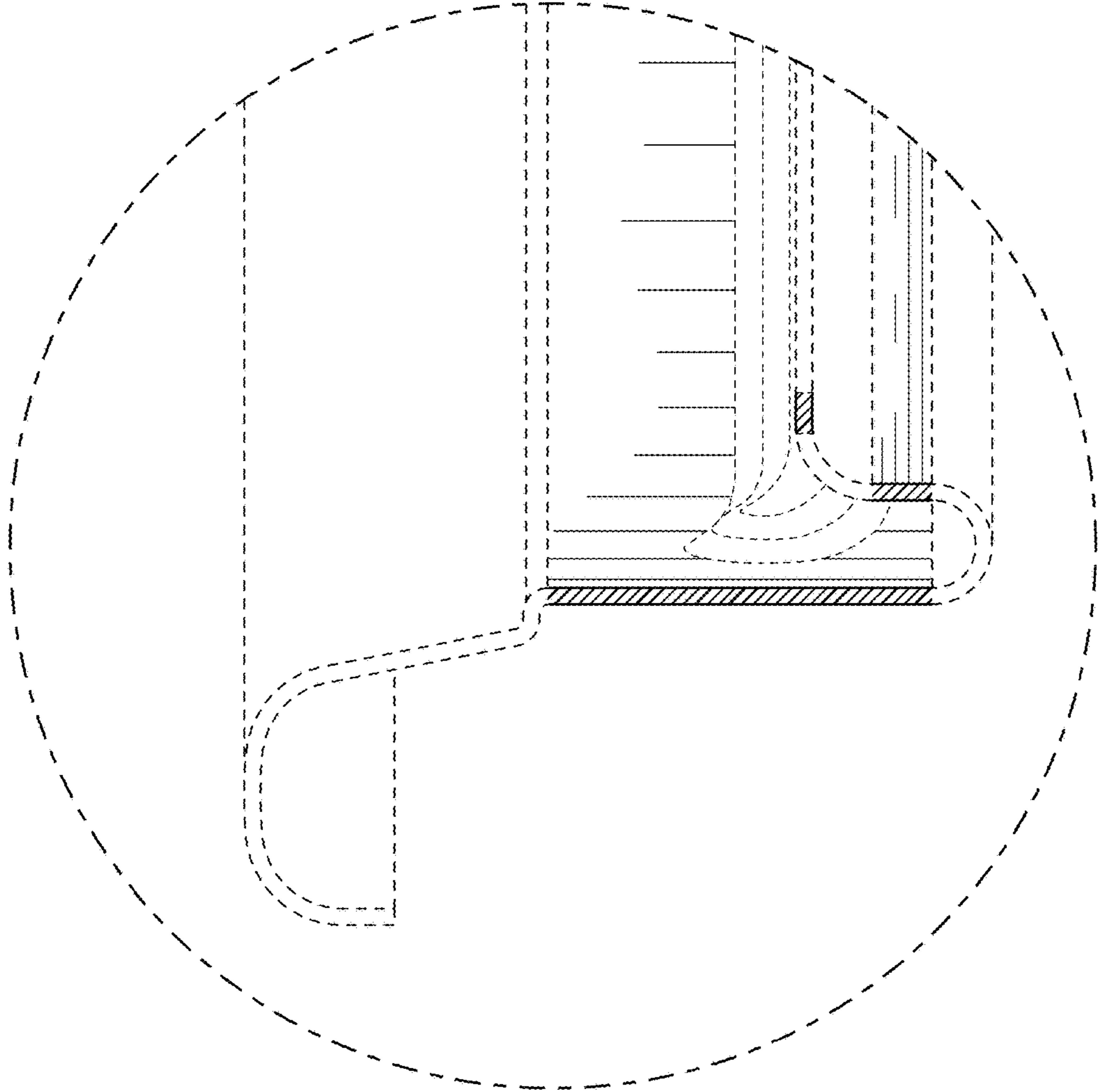

FIG. 14

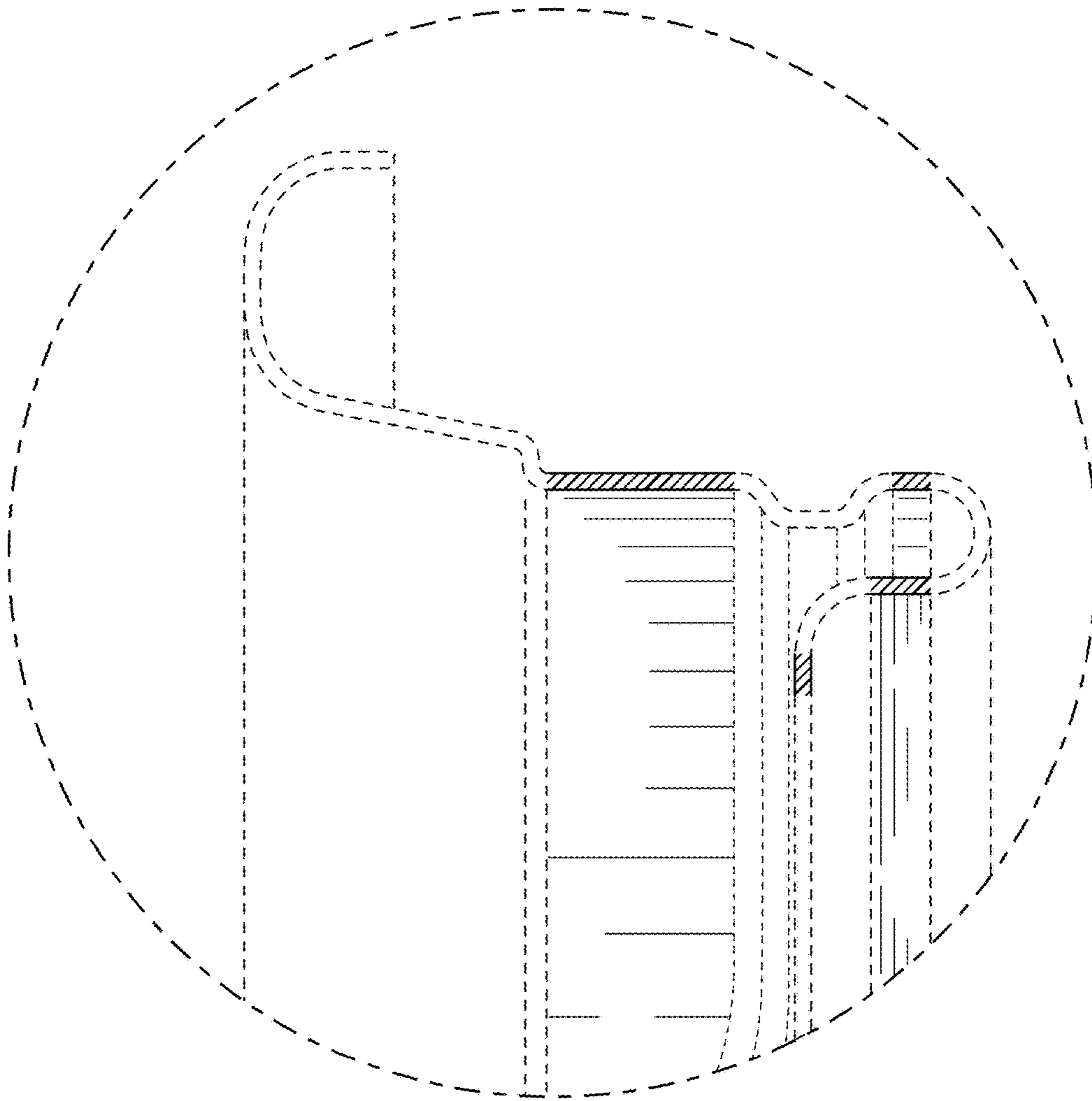

FIG. 15