



US00D795579S

(12) **United States Design Patent** (10) **Patent No.:** **US D795,579 S**
Sarfati et al. (45) **Date of Patent:** **** Aug. 29, 2017**

(54) **ORGANIZER**
(71) Applicant: **The Stanley Works Israel Ltd.**, Rosh Ha' Ayin (IL)
(72) Inventors: **Boaz Sarfati**, Rosh Ha' ayin (IL); **Yaron Shpitzer**, Rishon Le Tsiyon (IL); **Mark Bensman**, Rosh Ha' Ayin (IL)
(73) Assignee: **THE STANLEY WORKS ISRAEL LTD** (IL)

D645,663 S * 9/2011 Henley D3/294
8,459,488 B2 * 6/2013 Pannier, II B65D 25/04
220/23.83
D703,437 S * 4/2014 Bar-Erez D3/282
D720,927 S * 1/2015 Liao D3/273
D725,388 S * 3/2015 Cole D3/282
D731,791 S * 6/2015 Youmans D3/282
D738,622 S * 9/2015 Sabbag D3/282
RE45,787 E * 11/2015 Hurt D3/294
D759,378 S * 6/2016 West D3/294
2003/0038142 A1 * 2/2003 Gee A45C 13/005
220/835

(**) Term: **15 Years**

(21) Appl. No.: **29/559,626**

(22) Filed: **Mar. 30, 2016**

(51) **LOC (10) Cl.** **03-01**

(52) **U.S. Cl.**
USPC **D3/294; D3/905**

(58) **Field of Classification Search**
USPC D3/905, 276, 279-284, 291, 294, 295, D3/298, 901, 302, 272, 273, 274, 903
CPC . B25H 3/02-3/028; B25H 3/00; B25H 3/003; B25H 3/006
See application file for complete search history.

(56) **References Cited**

U.S. PATENT DOCUMENTS

D358,765 S * 5/1995 Dickinson D3/279
D595,958 S * 7/2009 Twig D3/294
D617,987 S * 6/2010 Wang D3/294
D639,059 S * 6/2011 Fraiman D3/282

* cited by examiner

Primary Examiner — Jennifer Rivard

Assistant Examiner — April Rivas

(74) *Attorney, Agent, or Firm* — Carl E. Myers

(57) **CLAIM**

The ornamental design for an organizer, as shown and described.

DESCRIPTION

FIG. 1 is a perspective view of a an embodiment of our new design.

FIG. 2 is a front view thereof.

FIG. 3 is a back view thereof.

FIG. 4 is a top view thereof.

FIG. 5 is a bottom view thereof.

FIG. 6 is a right side view thereof; and,

FIG. 7 is a left side view thereof.

The broken lines illustrate portions of the organizer and form no part of the claimed design.

1 Claim, 7 Drawing Sheets

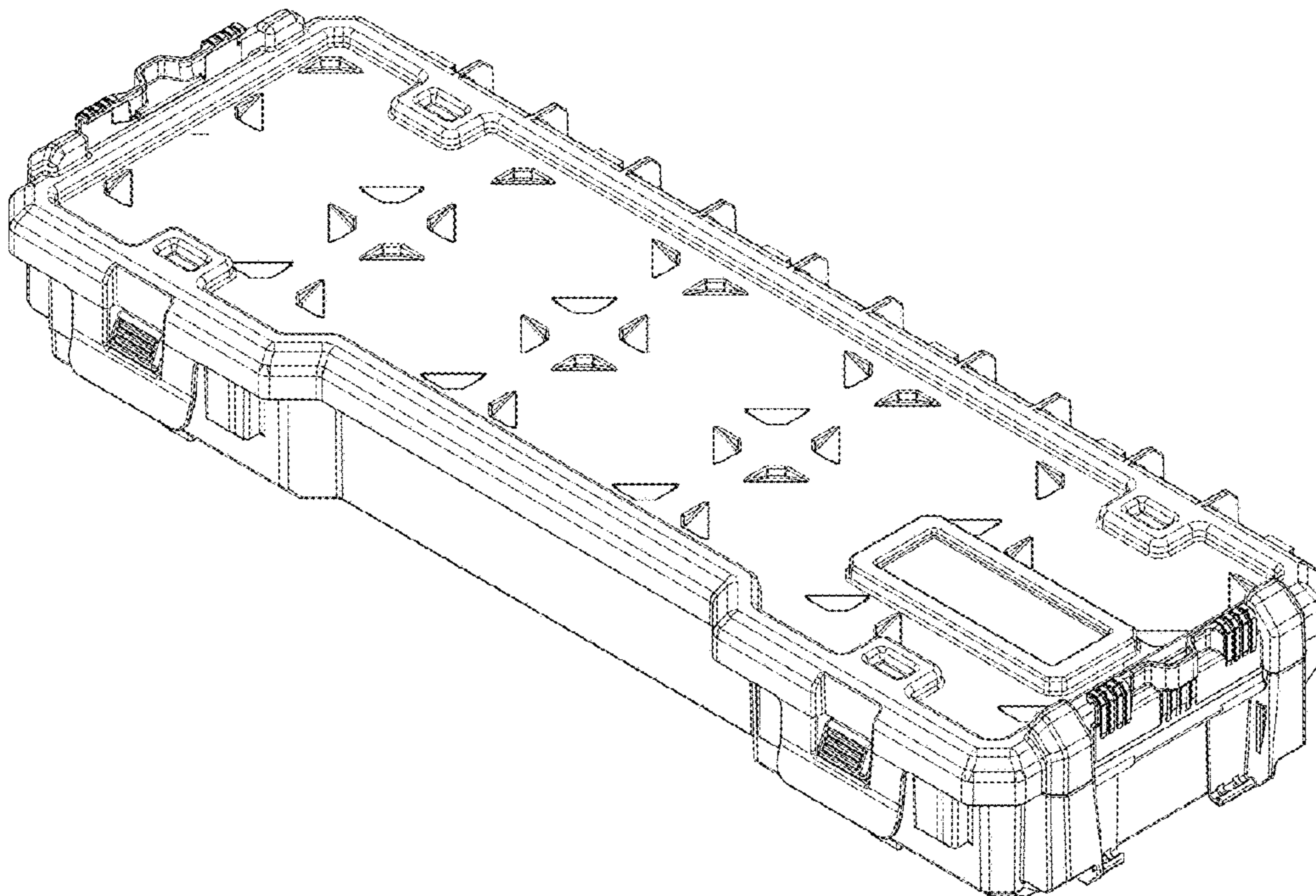

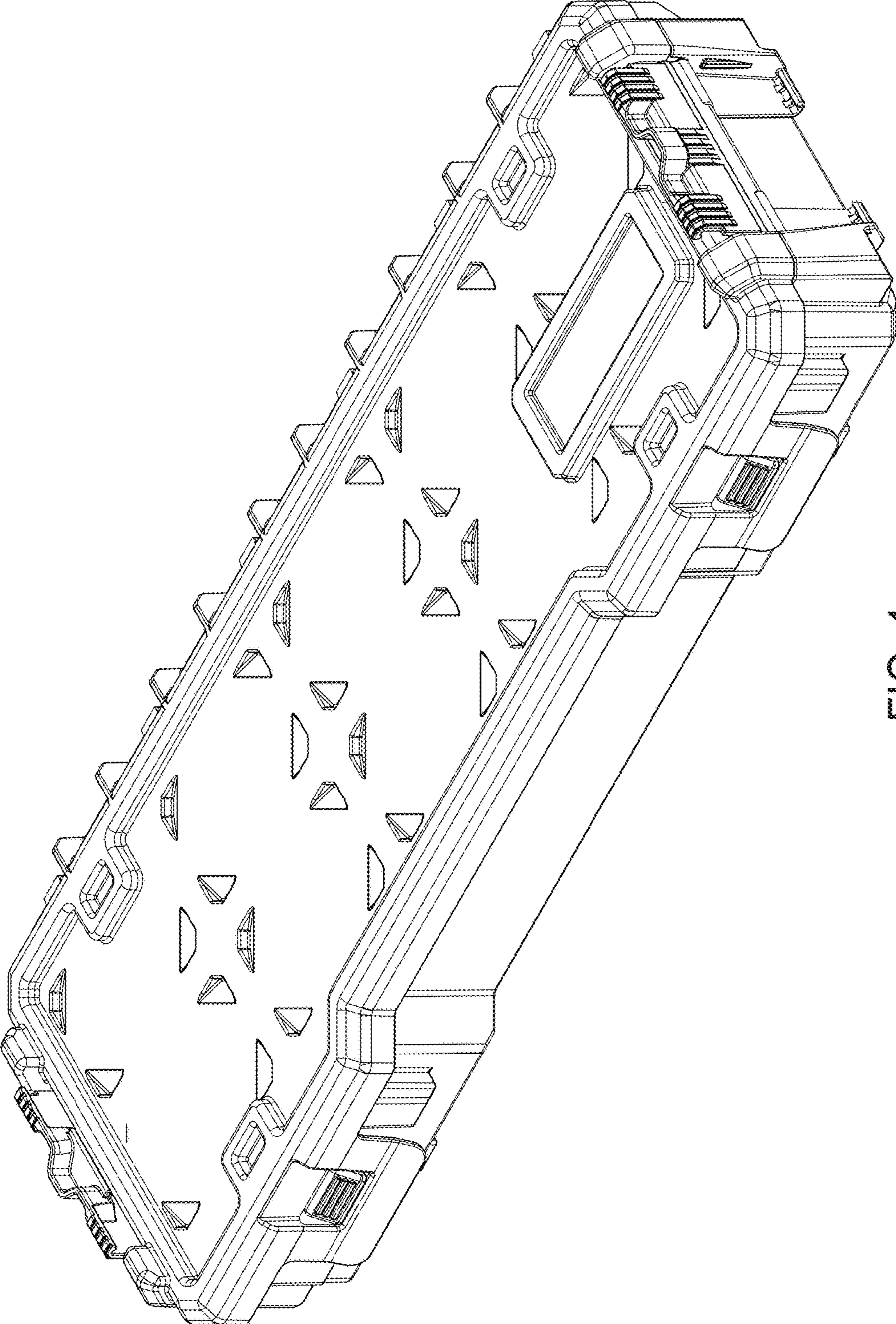

FIG. 1

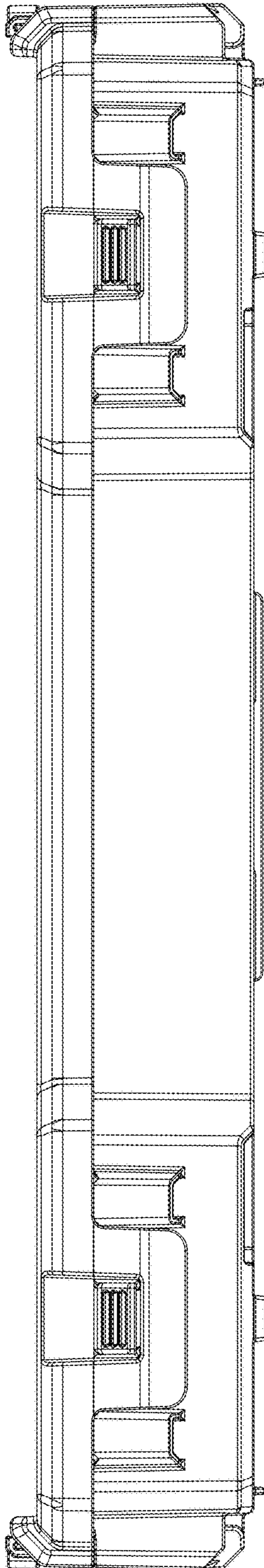

FIG. 2

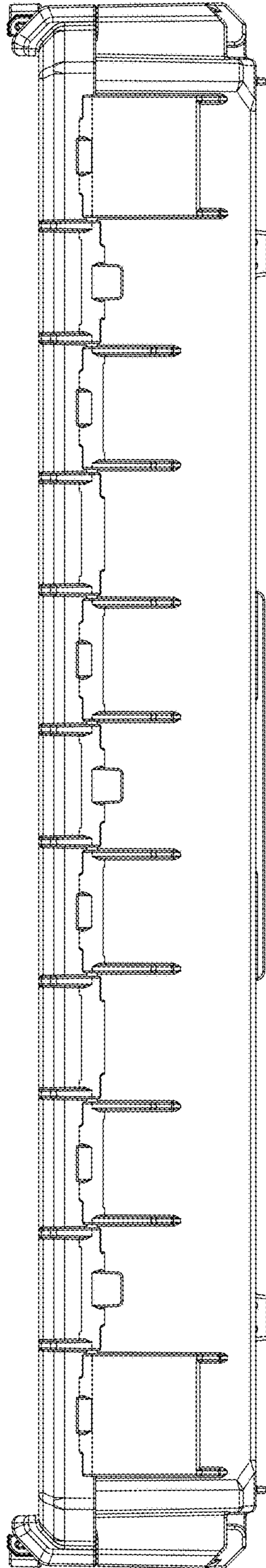

FIG. 3

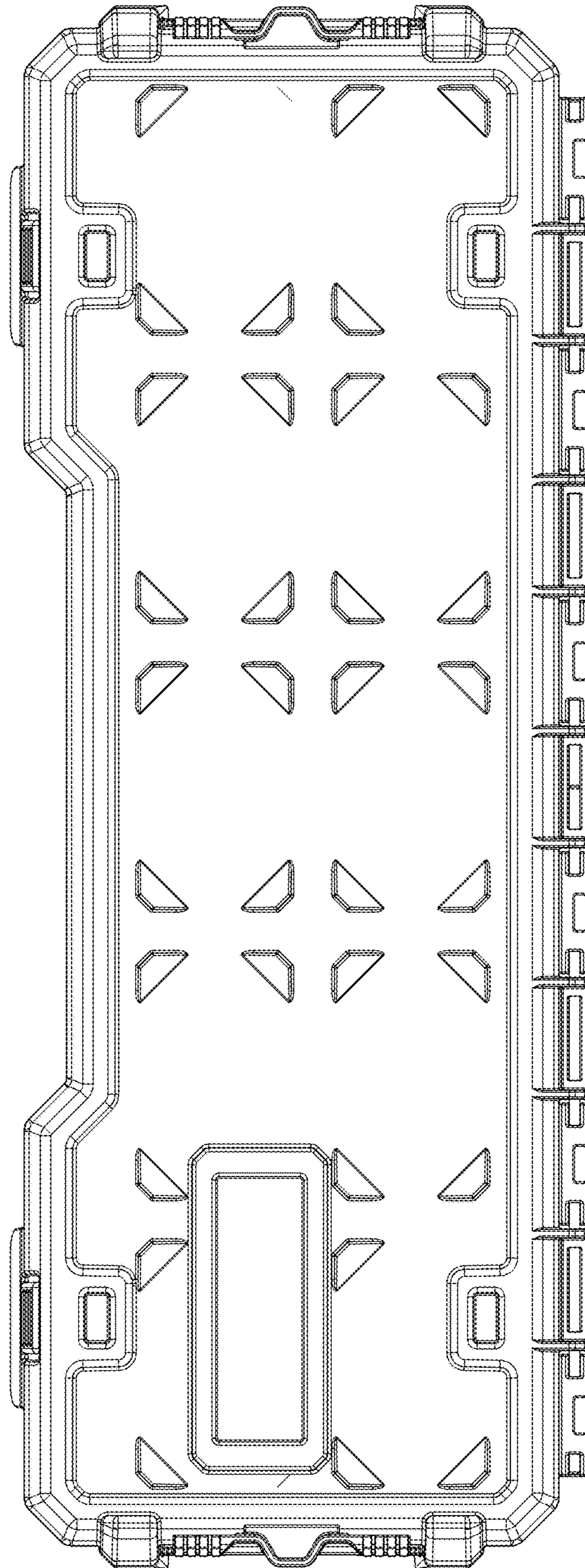

FIG. 4

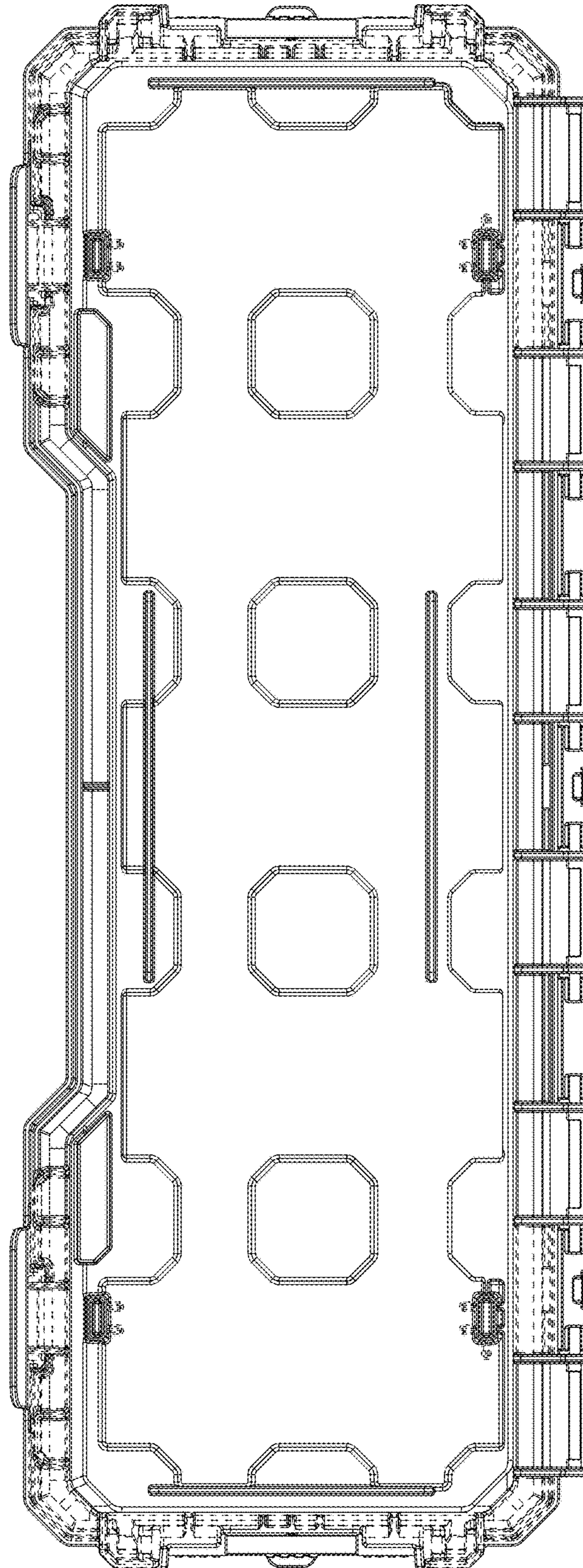

FIG. 5

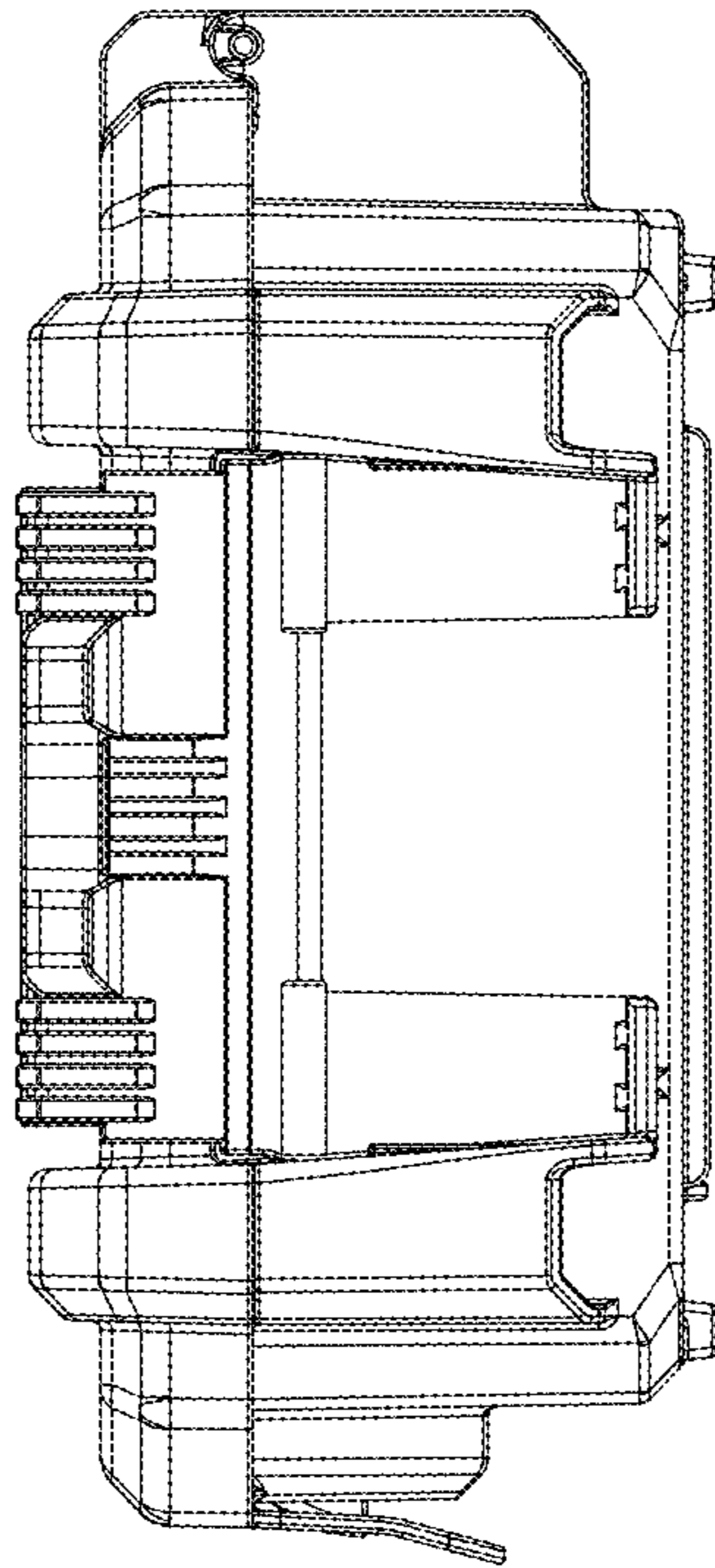

FIG. 6

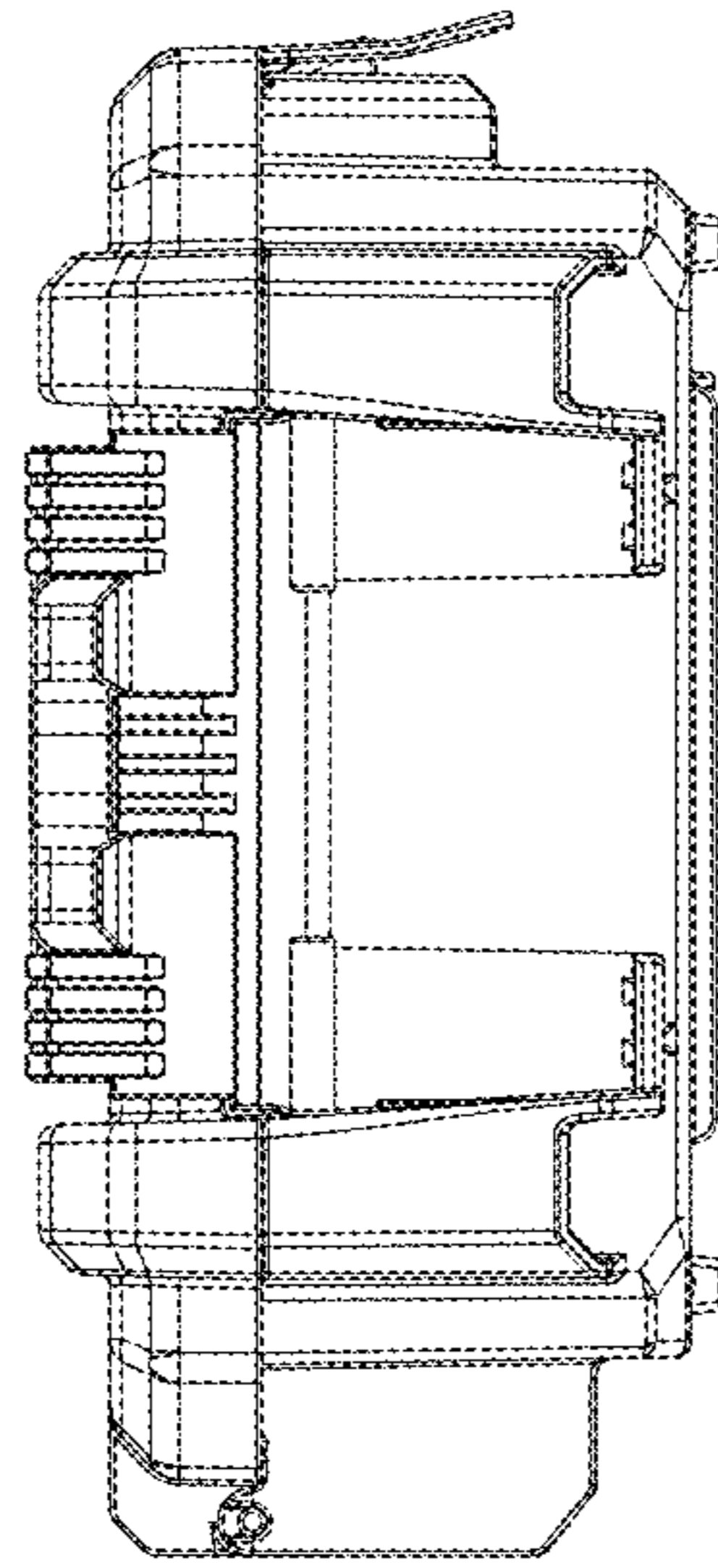

FIG. 7