



US00D795534S

(12) **United States Design Patent**
Harris

(10) **Patent No.:** **US D795,534 S**

(45) **Date of Patent:** **** Aug. 29, 2017**

(54) **PANT**

(71) Applicant: **NIKE, Inc.**, Beaverton, OR (US)

(72) Inventor: **Donavan Harris**, Portland, OR (US)

(73) Assignee: **NIKE, Inc.**, Beaverton, OR (US)

(**) Term: **15 Years**

(21) Appl. No.: **29/546,199**

(22) Filed: **Nov. 19, 2015**

(51) **LOC (10) Cl.** **02-02**

(52) **U.S. Cl.**

USPC **D2/742**

(58) **Field of Classification Search**

USPC D2/700, 728, 742, 999

CPC A41D 13/00; A41D 11/00; A41D 2600/10;

A41D 7/00; A41D 2400/00; A63B

71/1225; A63B 71/14; A41F 17/00

See application file for complete search history.

(56) **References Cited**

U.S. PATENT DOCUMENTS

218,472 A 8/1879 Banner

373,628 A 11/1887 Wood

454,736 A 6/1891 Hill

(Continued)

FOREIGN PATENT DOCUMENTS

EP 0643929 A1 3/1995

OTHER PUBLICATIONS

“Equissentials Breeches, pants, and jodhpurs with deer skin leather seats or leg patches,” The Tailored Horse, thetailoredhorse.com, Last Accessed Apr. 30, 2015 at: <http://www.thetailoredhorse.com/page8.html>.

(Continued)

Primary Examiner — Caron D Veynar

Assistant Examiner — Mehri Bajoul

(74) *Attorney, Agent, or Firm* — Shook, Hardy & Bacon L.L.P.

(57) **CLAIM**

The ornamental design for a pant, as shown and described.

DESCRIPTION

FIG. 1 is a front, left perspective view of a pant showing a first embodiment according to the present design;

FIG. 2 is a front view thereof;

FIG. 3 is a right view thereof;

FIG. 4 is a rear view thereof;

FIG. 5 is a top-down view thereof;

FIG. 6 is a bottom-up view thereof;

FIG. 7 is a cross-sectional view thereof taken along cut line 7 of FIG. 2;

FIG. 8 is a bottom-up view with the pant legs in a splayed configuration;

FIG. 9 is a front left perspective view of the pant in FIGS. 1-8 shown applied to a second pant;

FIG. 10 is a front view thereof;

FIG. 11 is a right view thereof;

FIG. 12 is a rear view thereof;

FIG. 13 is a top-down view thereof;

FIG. 14 is a bottom-up view thereof;

FIG. 15 is a cross-sectional view thereof taken along cut line 15 of FIG. 10; and,

FIG. 16 is a bottom-up view with the pant legs in a splayed configuration.

The evenly spaced broken lines shown in the drawings are directed to environment, are for informational purposes only, and form no part of the claimed design.

The surface shading on the claimed portion is provided only to indicate the character and/or any contour or curvature of the surfaces. They do not indicate color, texture, markings that actually exist thereon, indicia, graphic representations, surface treatment, or any other ornamentation applied to the article.

1 Claim, 8 Drawing Sheets

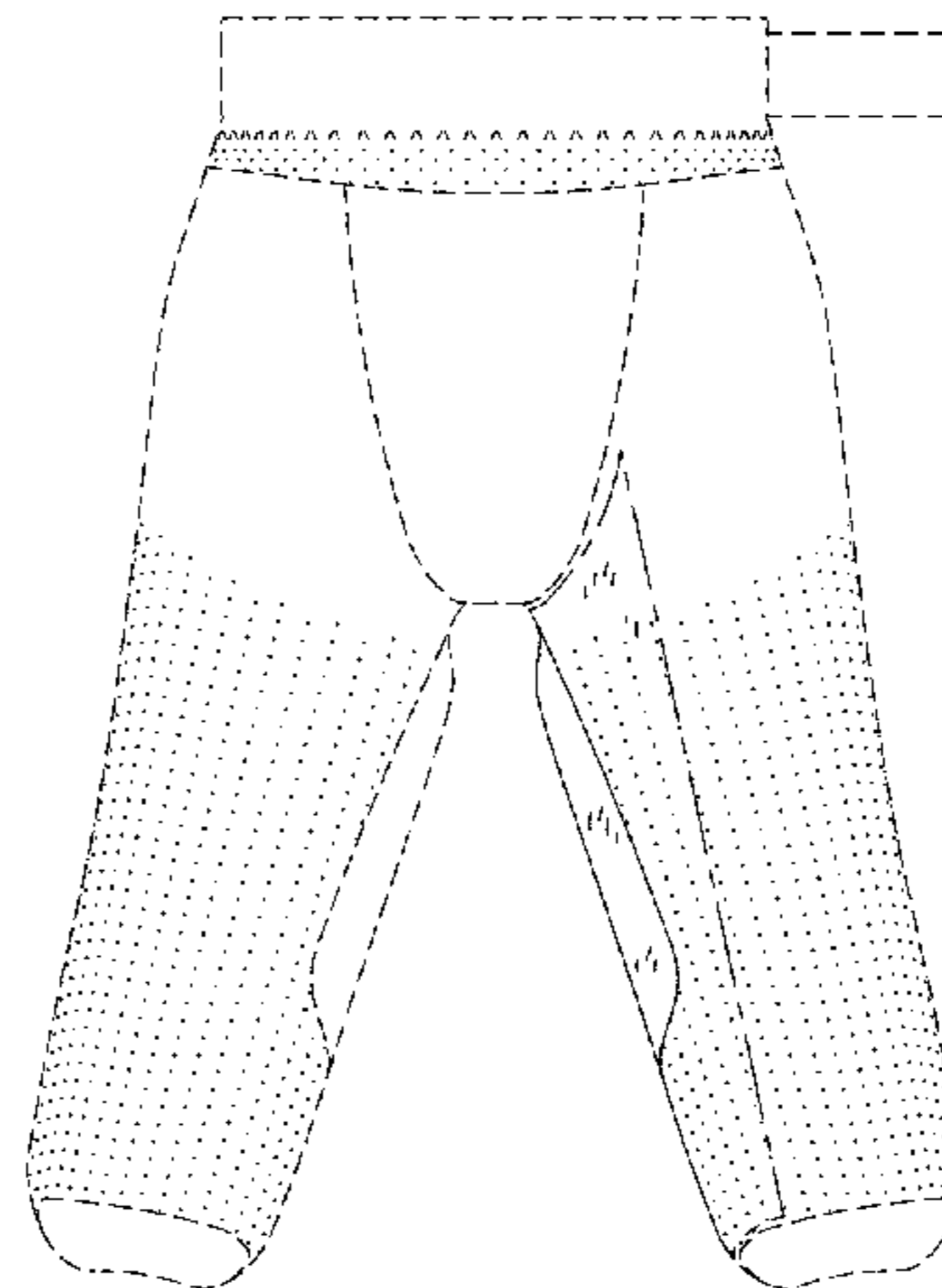
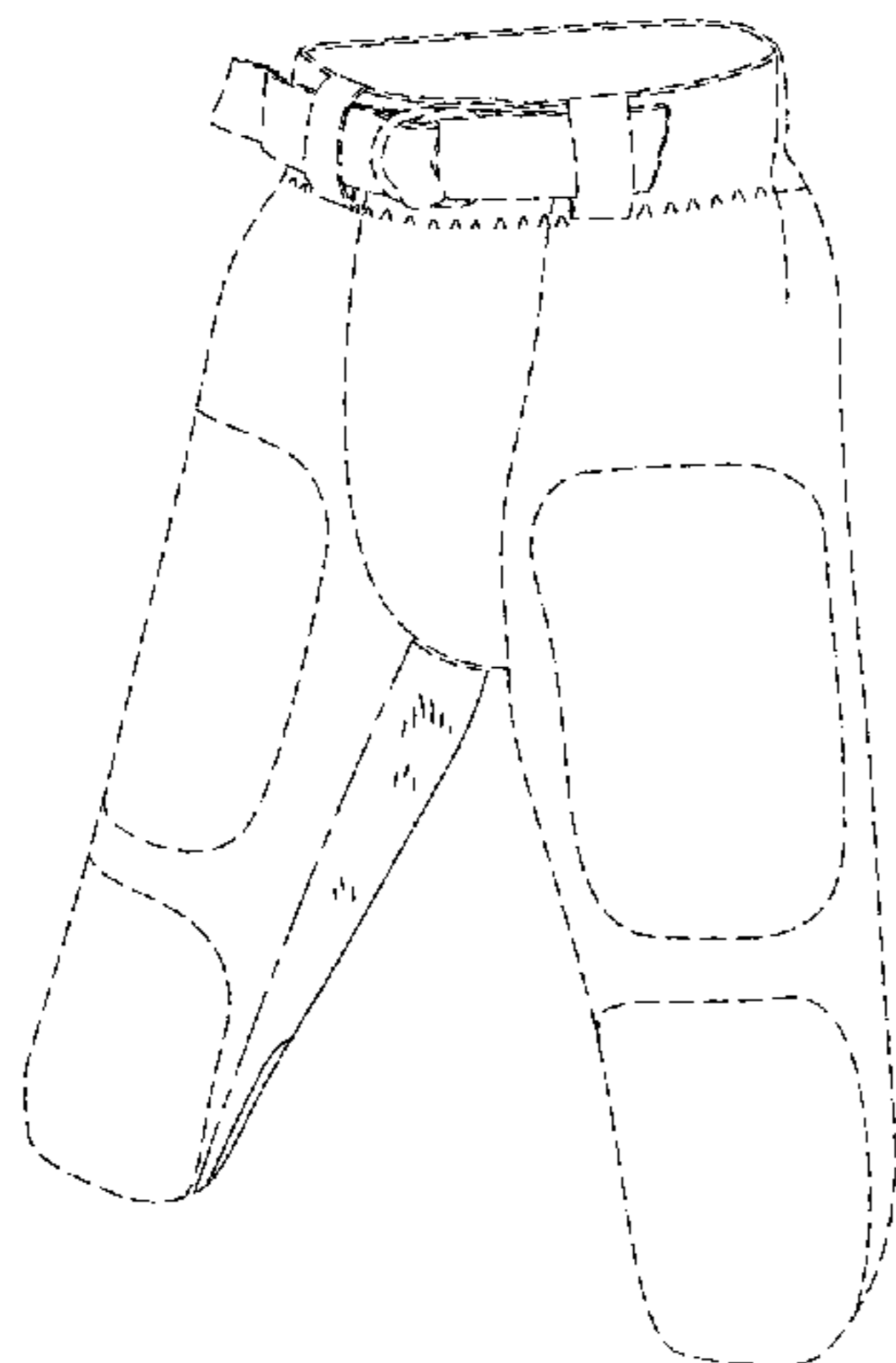

(56)

References Cited

U.S. PATENT DOCUMENTS

1,784,744 A 12/1930 Negley
 2,318,199 A 5/1943 Clements
 2,570,497 A * 10/1951 Senderowitz A41B 9/04
 2/401
 2,629,094 A 2/1953 Goldsmith
 4,261,060 A 4/1981 Zawacki
 4,371,989 A 2/1983 Polsky
 4,785,480 A 11/1988 Polsky
 4,893,355 A 1/1990 Ritter
 4,989,272 A 2/1991 Wagner
 5,033,123 A 7/1991 Audet
 D360,516 S * 7/1995 Persinger D2/712
 D370,552 S 6/1996 Erwin et al.
 5,611,081 A 3/1997 Torres
 5,732,412 A 3/1998 Holden
 D404,889 S 2/1999 Fujii et al.
 6,041,441 A 3/2000 Counts et al.
 D427,750 S * 7/2000 Fujii D2/731
 6,161,222 A * 12/2000 Strickland A41D 1/08
 2/228
 D440,028 S 4/2001 Korff
 D460,602 S 7/2002 Tanaka
 6,421,831 B1 7/2002 Korff
 D466,674 S 12/2002 Tanaka
 D481,523 S 11/2003 Hujii et al.
 D483,551 S 12/2003 Kallen
 D483,924 S 12/2003 Morisset
 D492,837 S 7/2004 Hujii et al.
 D507,857 S 8/2005 Ota
 D520,715 S * 5/2006 Ota A41D 13/08
 D2/731
 D525,765 S * 8/2006 Arensdorf D2/712
 D532,958 S 12/2006 Kent
 D546,029 S * 7/2007 Rindle D2/738
 7,500,274 B1 * 3/2009 Kallen A41D 1/086
 2/227
 7,533,423 B2 * 5/2009 Rudolph A41D 1/086
 2/227

D595,933 S 7/2009 Clement
 7,730,552 B2 6/2010 Ota et al.
 D619,784 S * 7/2010 Kanada D2/742
 7,805,774 B2 10/2010 Müller
 D648,922 S 11/2011 Evans et al.
 8,296,864 B2 10/2012 Torry
 8,561,214 B2 * 10/2013 Turner A41D 13/0156
 2/227
 D698,520 S 2/2014 Anderson et al.
 D742,096 S * 11/2015 Darmour D2/742
 D764,756 S 8/2016 Maguire
 D764,757 S 8/2016 Criss
 2010/0167626 A1 7/2010 Hamlet
 2010/0218298 A1 9/2010 Stattelmann et al.
 2011/0265250 A1 * 11/2011 Jewell A41D 13/0581
 2/236
 2012/0052249 A1 3/2012 Turner
 2014/0173815 A1 6/2014 Grogro
 2014/0208492 A1 7/2014 Foley et al.
 2014/0230124 A1 8/2014 Wilms-Otto
 2014/0259323 A1 * 9/2014 Brandt A41D 13/015
 2/455
 2015/0201685 A1 7/2015 Brohmer
 2016/0050988 A1 2/2016 Carver
 2016/0324225 A1 * 11/2016 Pollack A41D 1/08
 2016/0374413 A1 12/2016 Imbert

OTHER PUBLICATIONS

“Adidas Climacool Checkdown Pant,” National Sports Apparel, nationalsportsapparel.com. Last Accessed Apr. 30, 2015 at: <http://nationalsportsapparel.com/product/adidas-climacool-checkdown-pant>.
 “Men’s Downieville Shorts,” North Face®, thenorthface.com, Last Accessed Apr. 30, 2015 at: <http://www.thenorthface.com/catalog/sc-gear/men-39-s-downievilleshort.html>.
 Design U.S. Appl. No. 29/530,054, filed Jun. 12, 2015.
 Notice of Allowance dated Jan. 13, 2017 in Design U.S. Appl. No. 29/530,054, 8 pages.

* cited by examiner

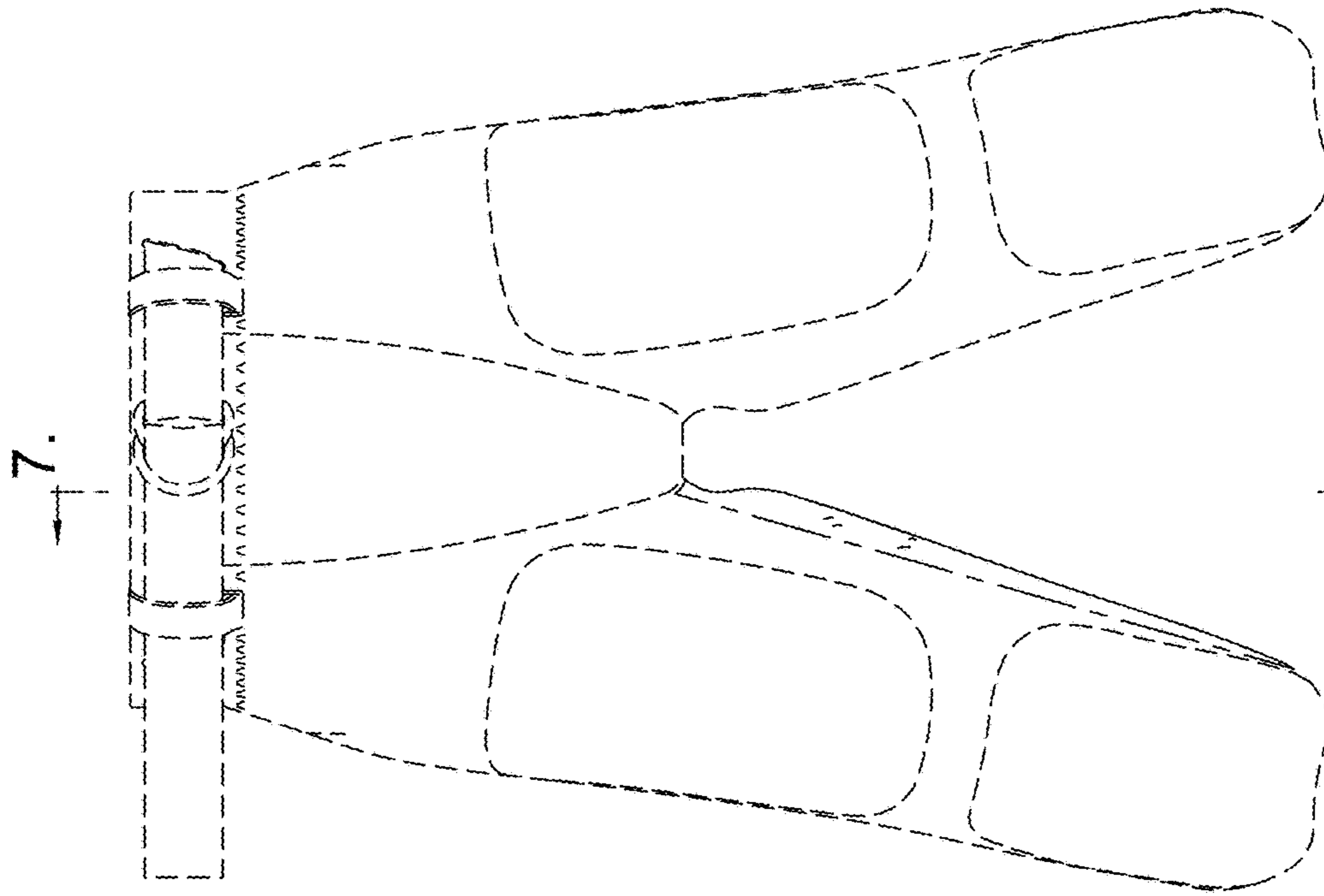

FIG. 1.

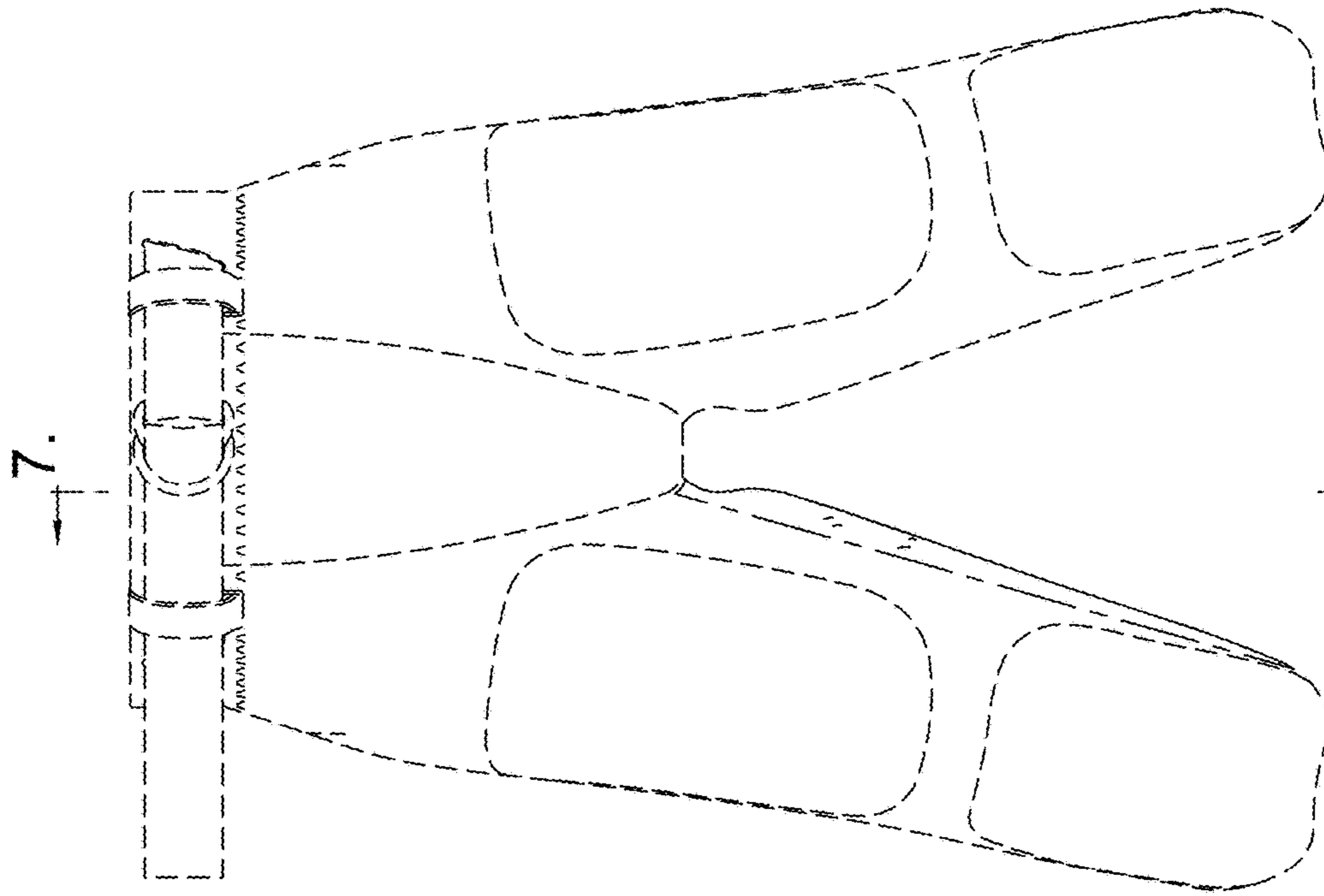

FIG. 2.

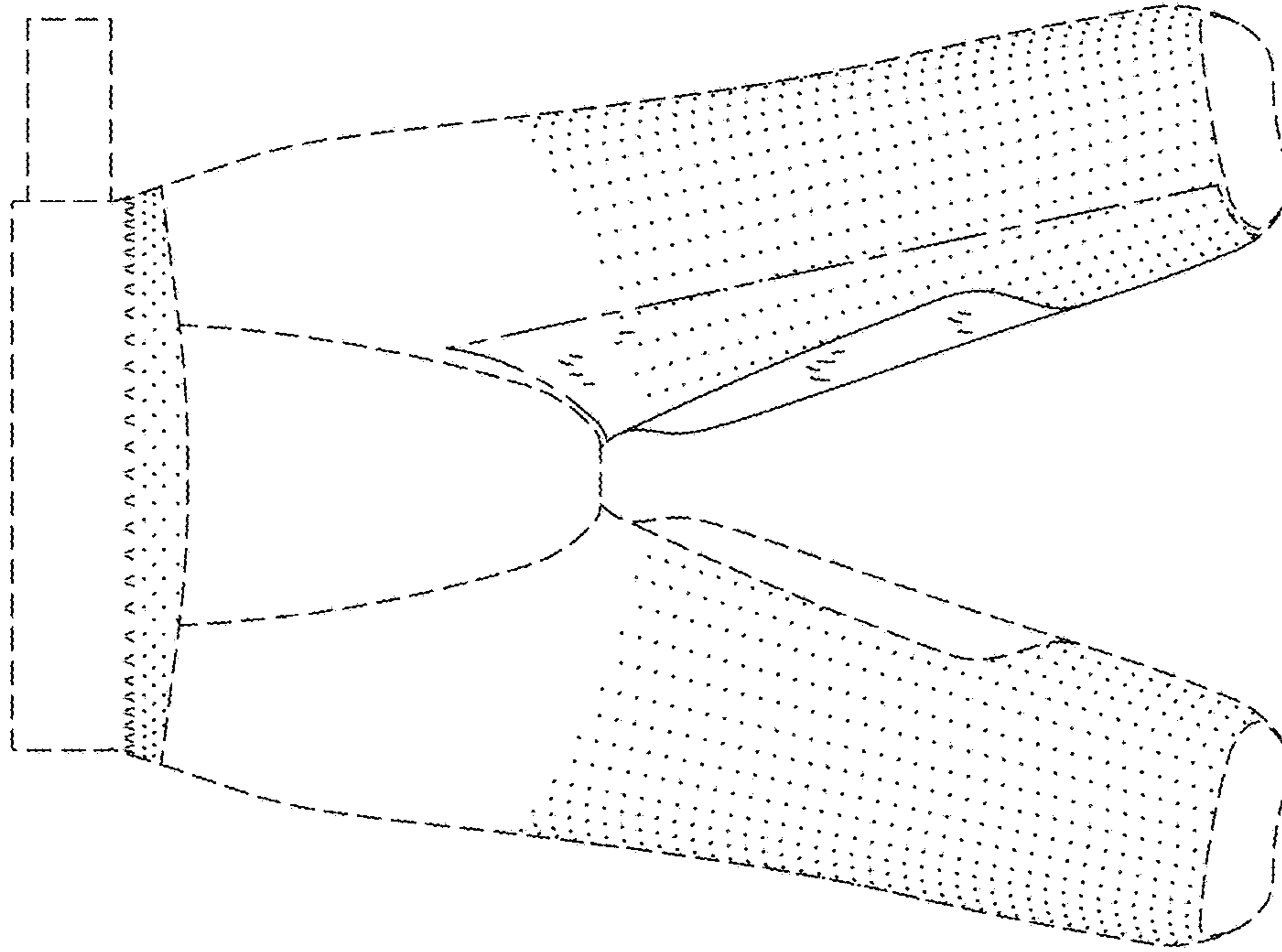

FIG. 4.

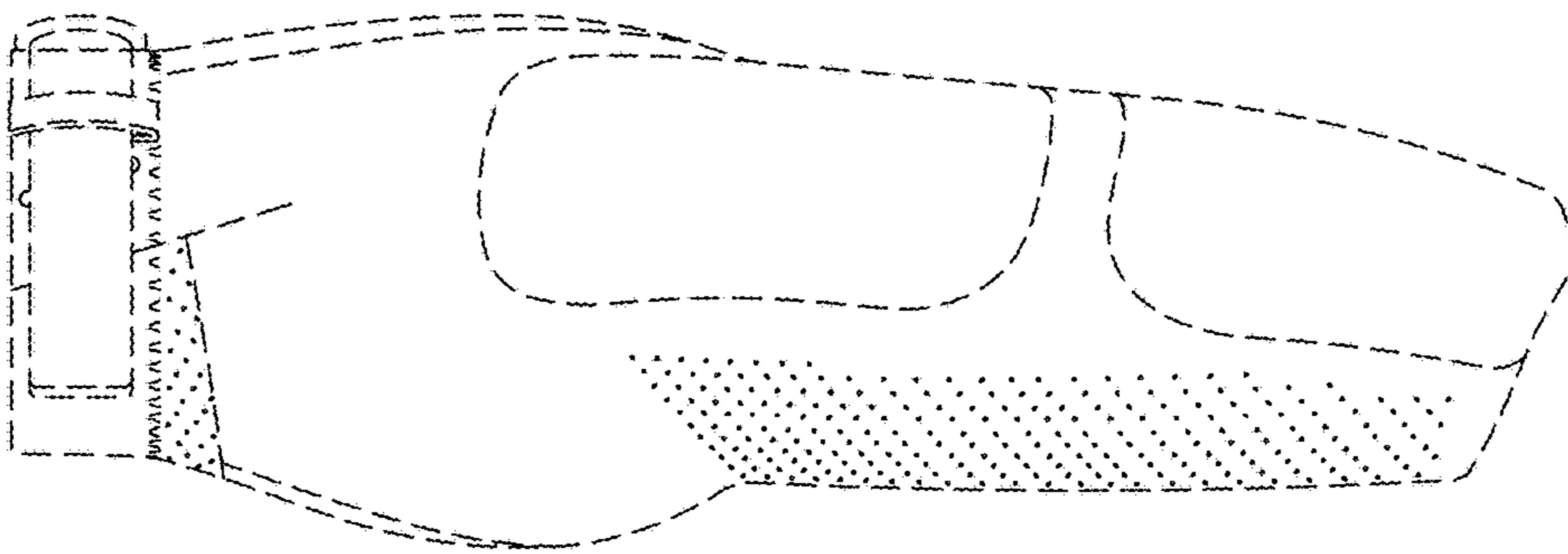

FIG. 3.

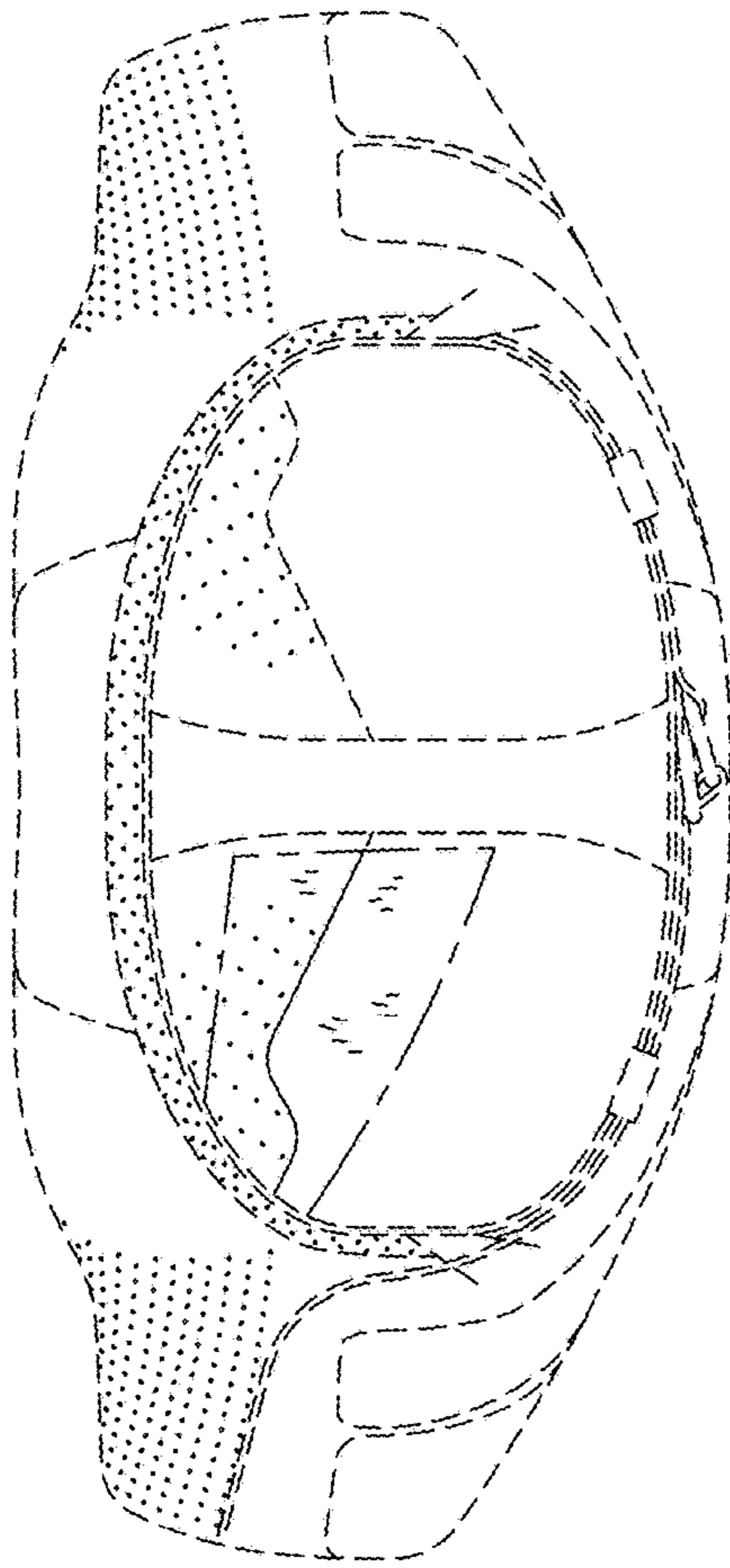

FIG. 5.

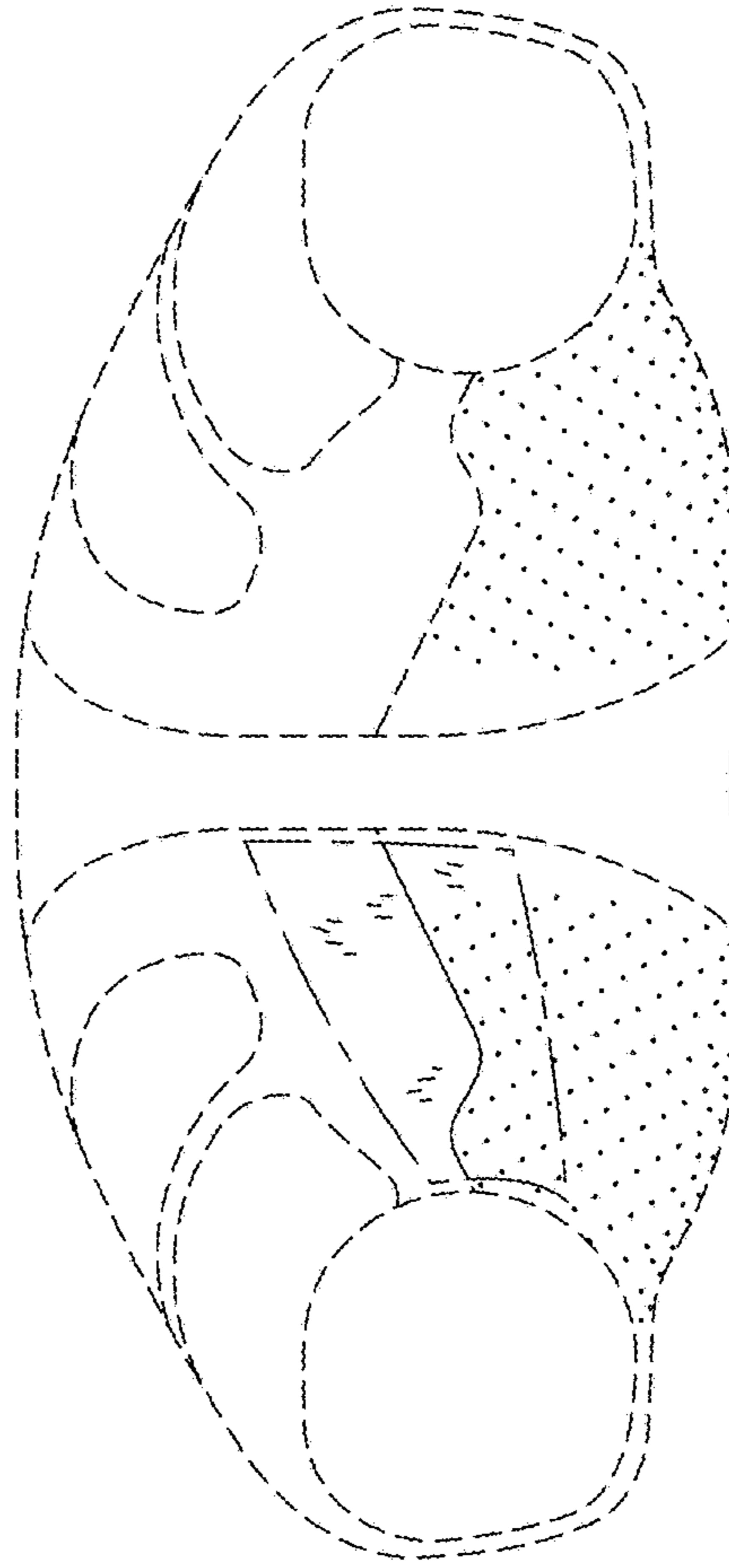

FIG. 6.

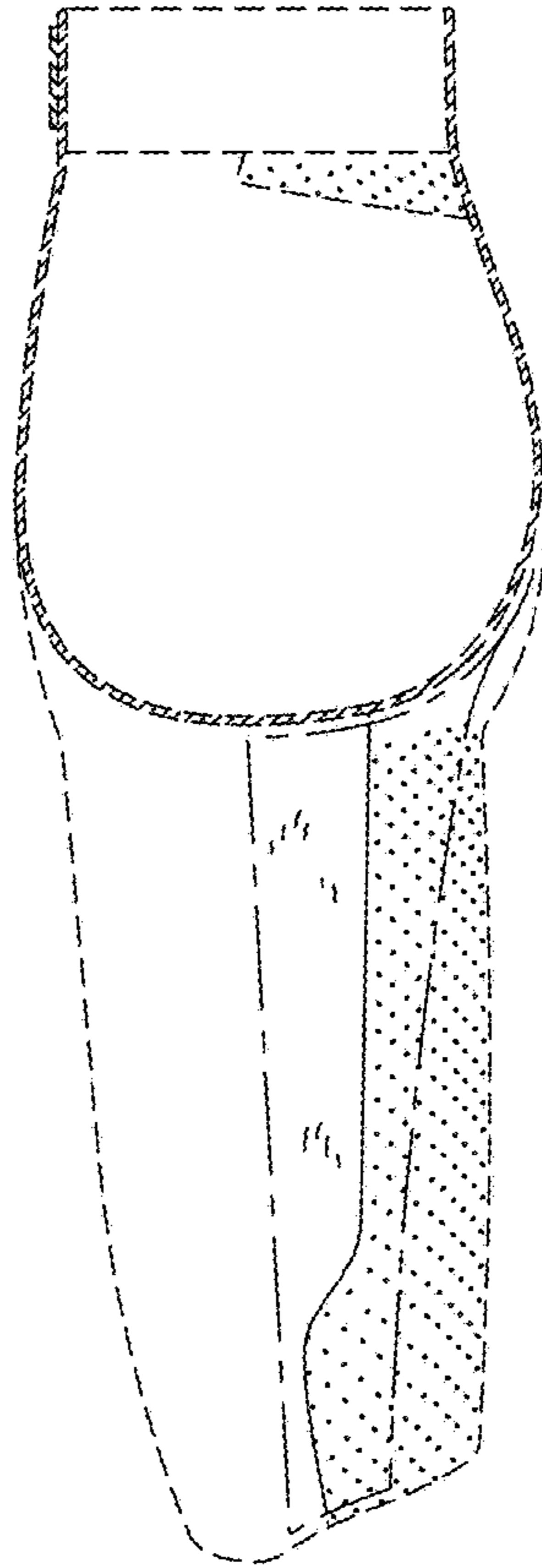

FIG. 7.

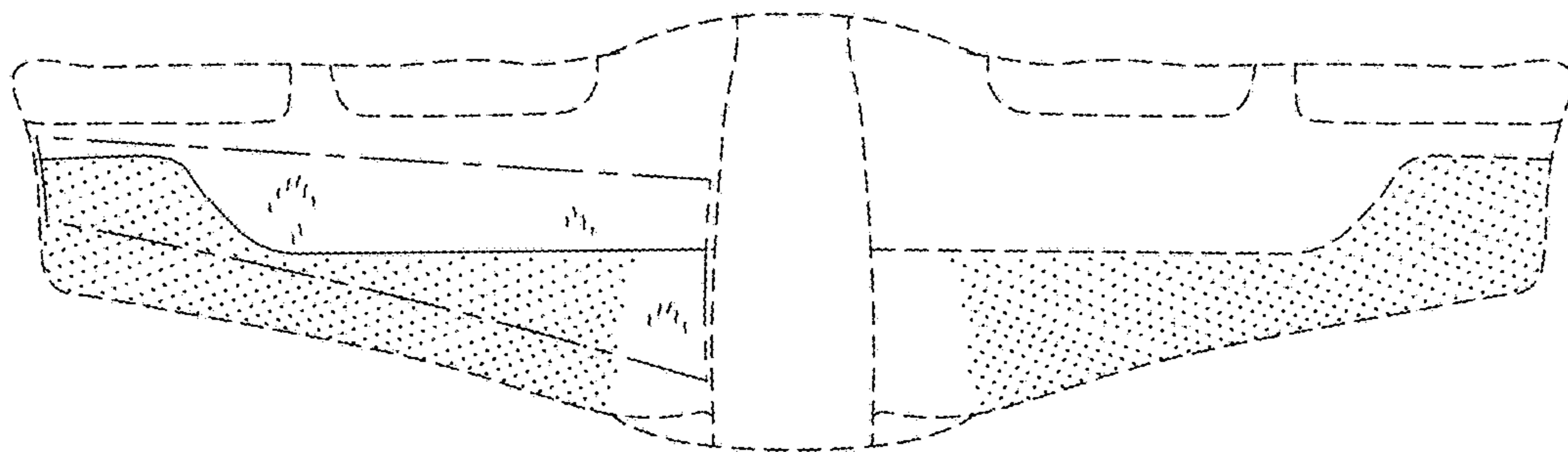

FIG. 8.

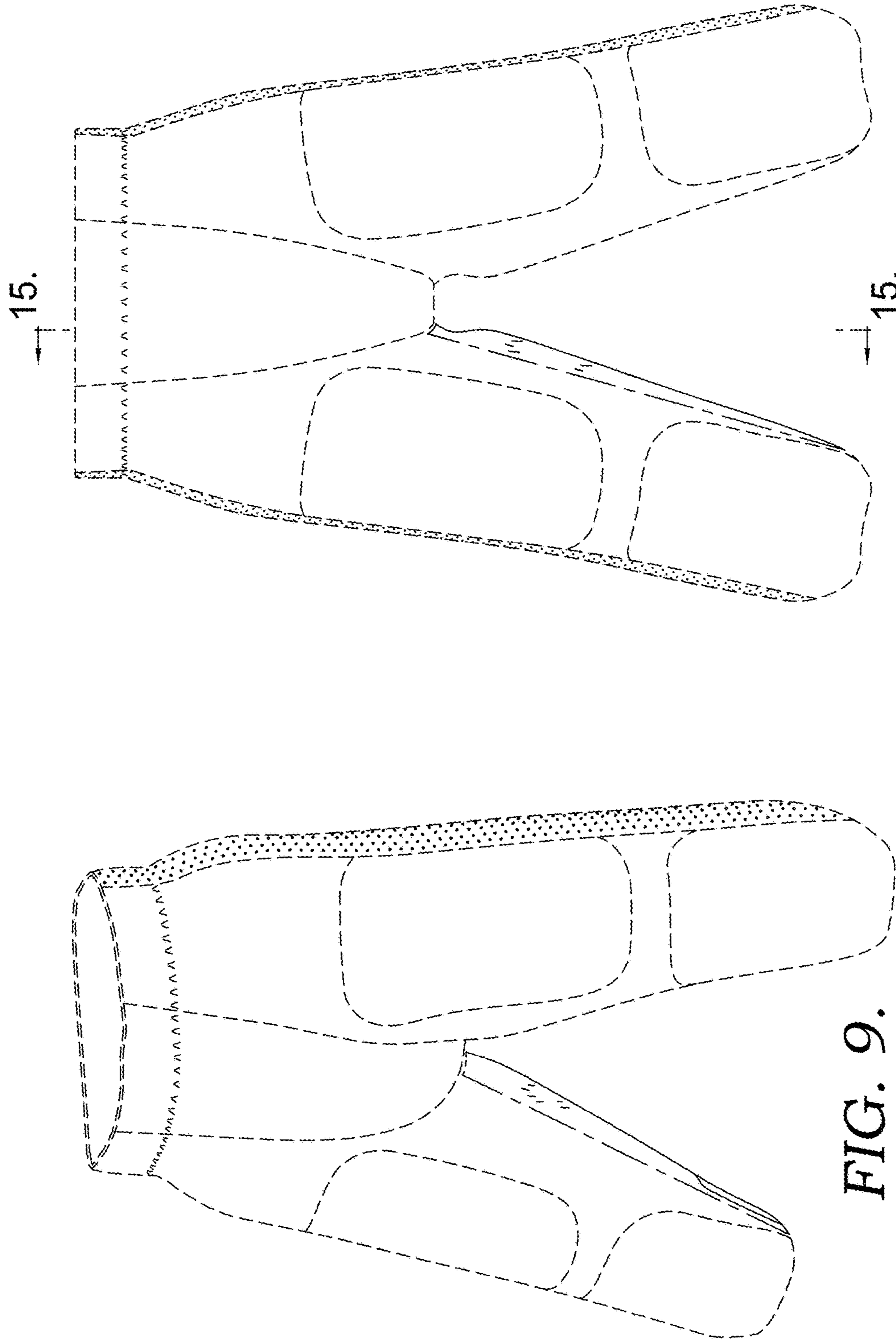

FIG. 9.

FIG. 10.

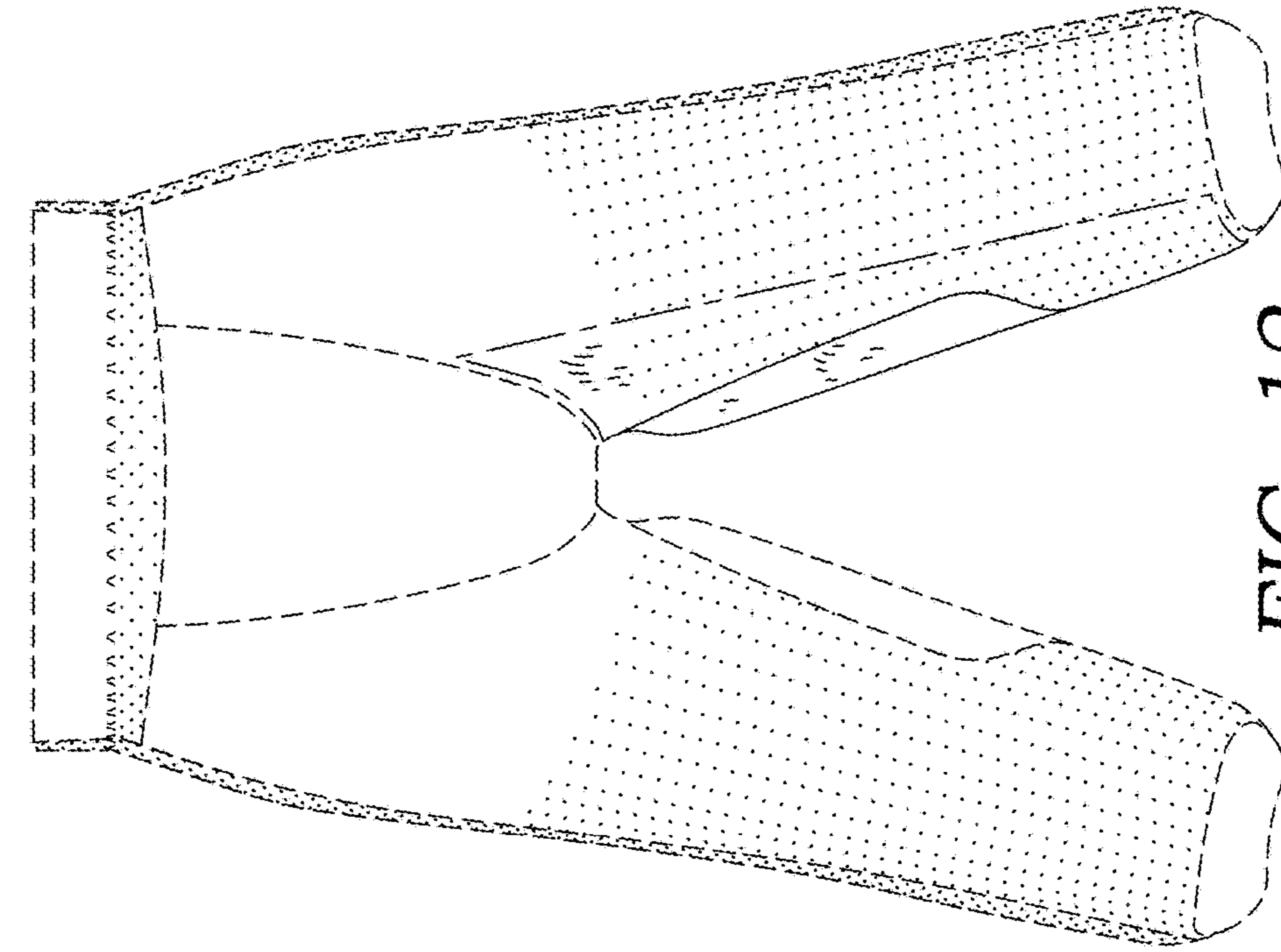

FIG. 11.

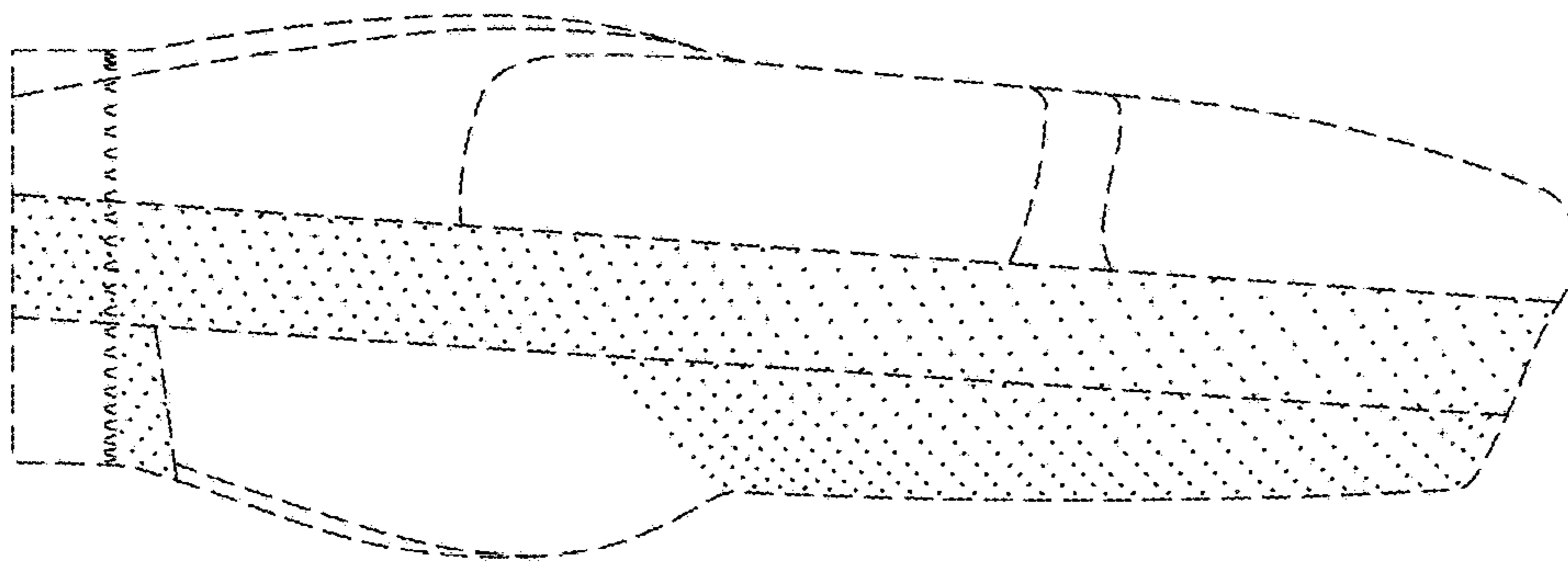

FIG. 12.

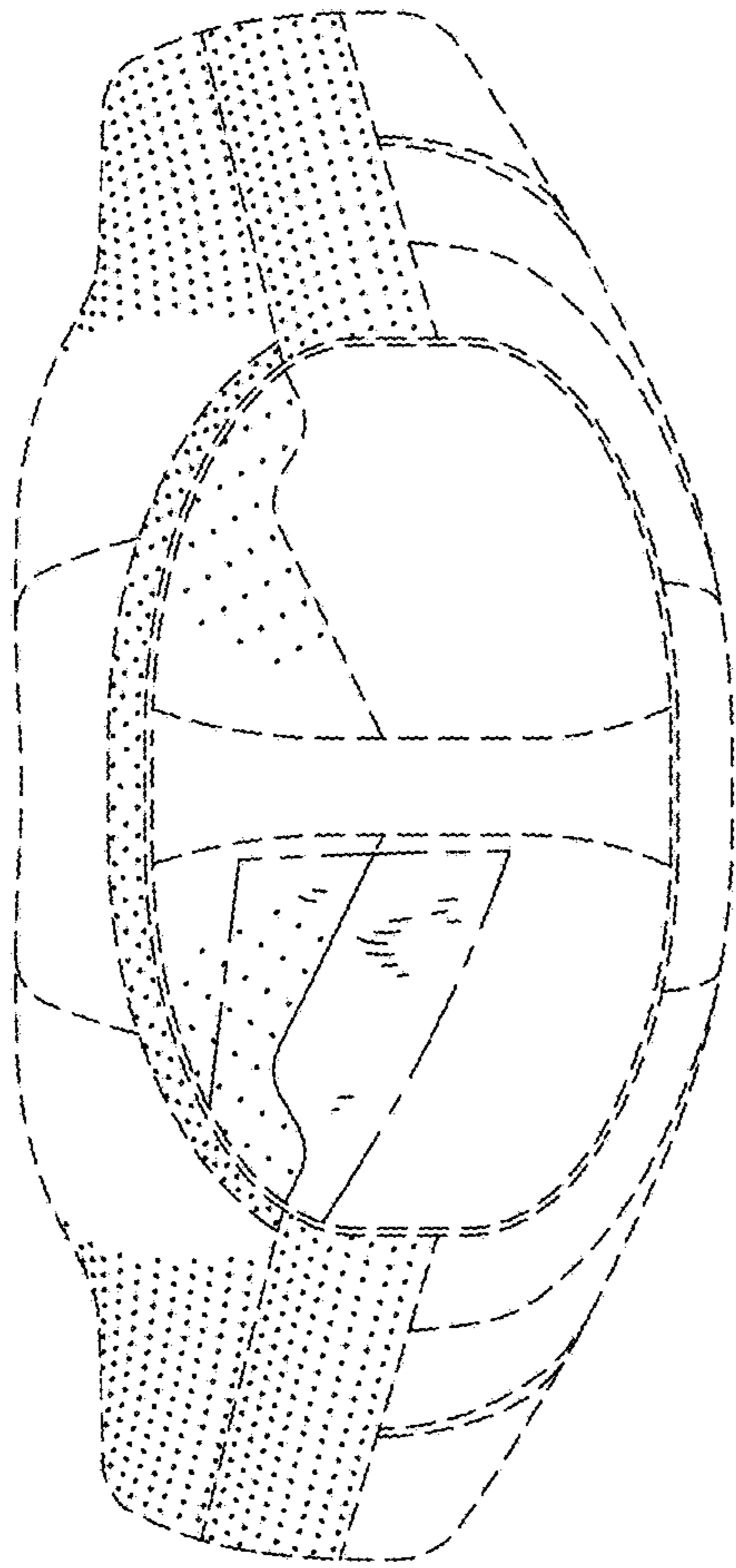

FIG. 13.

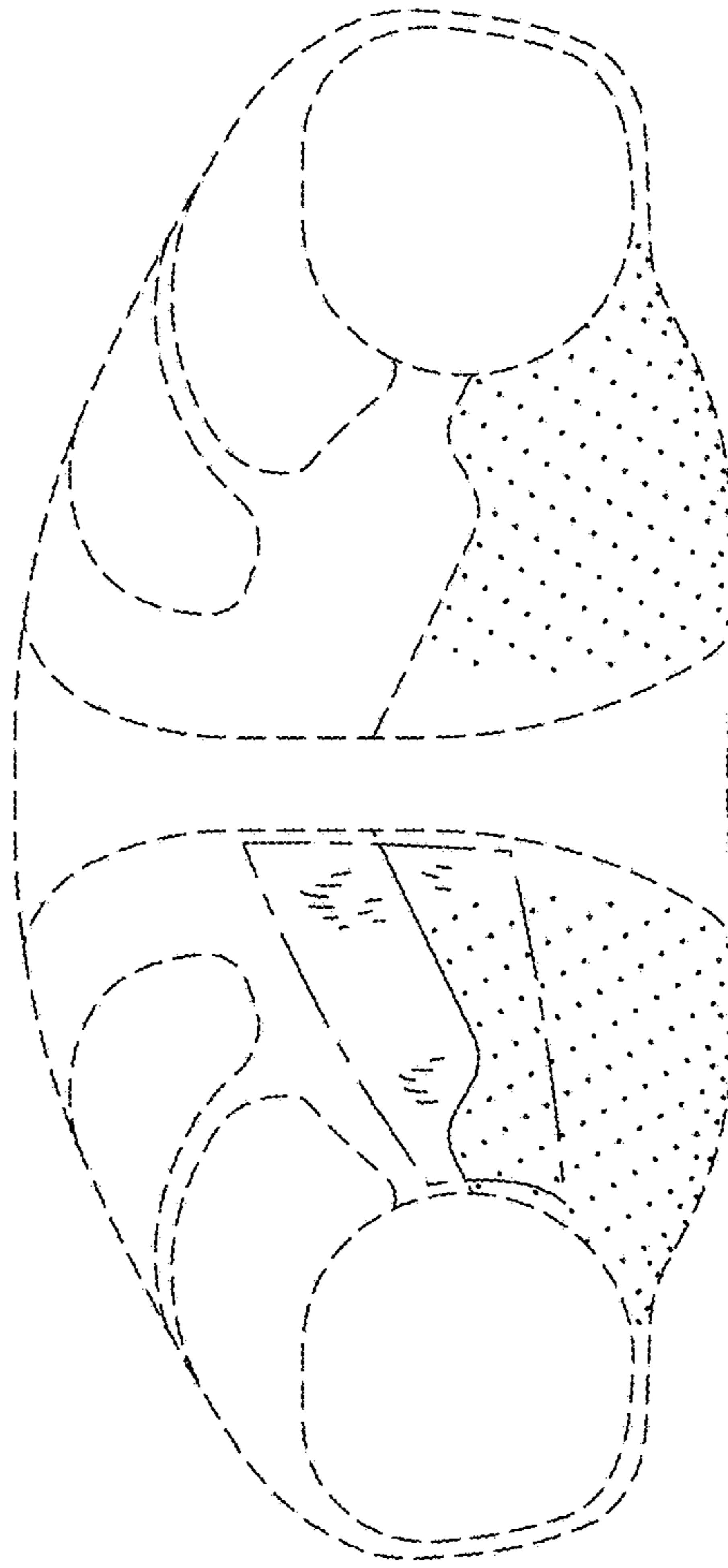

FIG. 14.

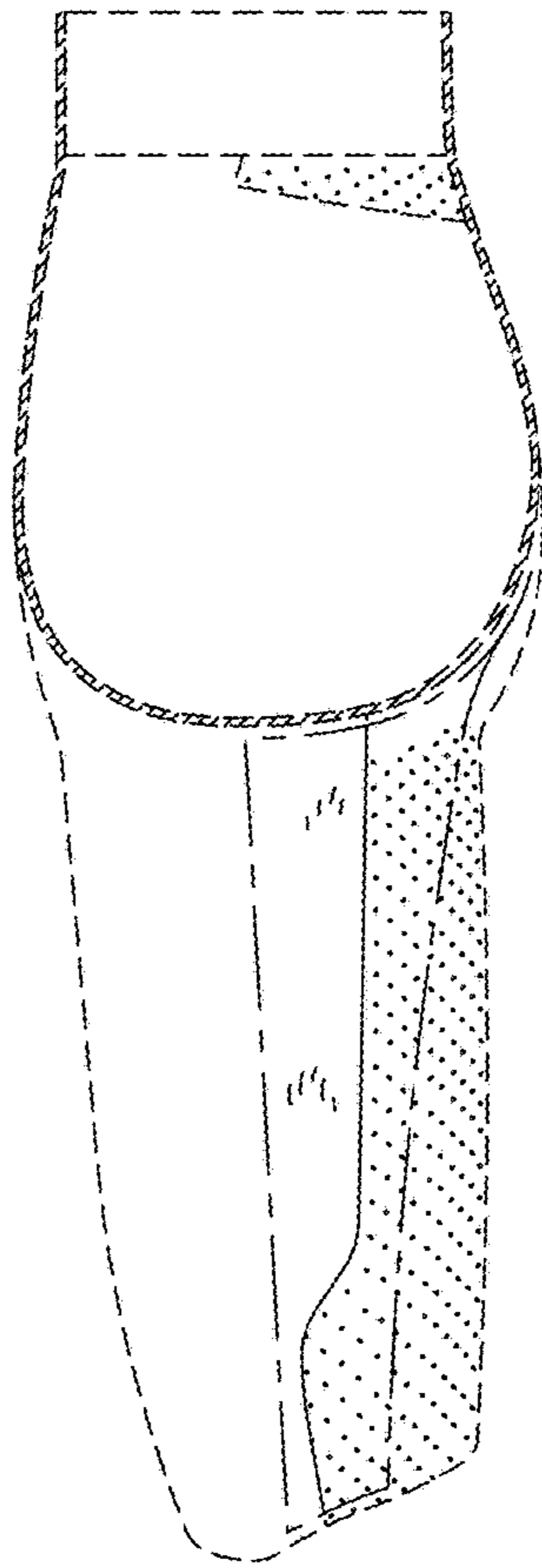

FIG. 15.

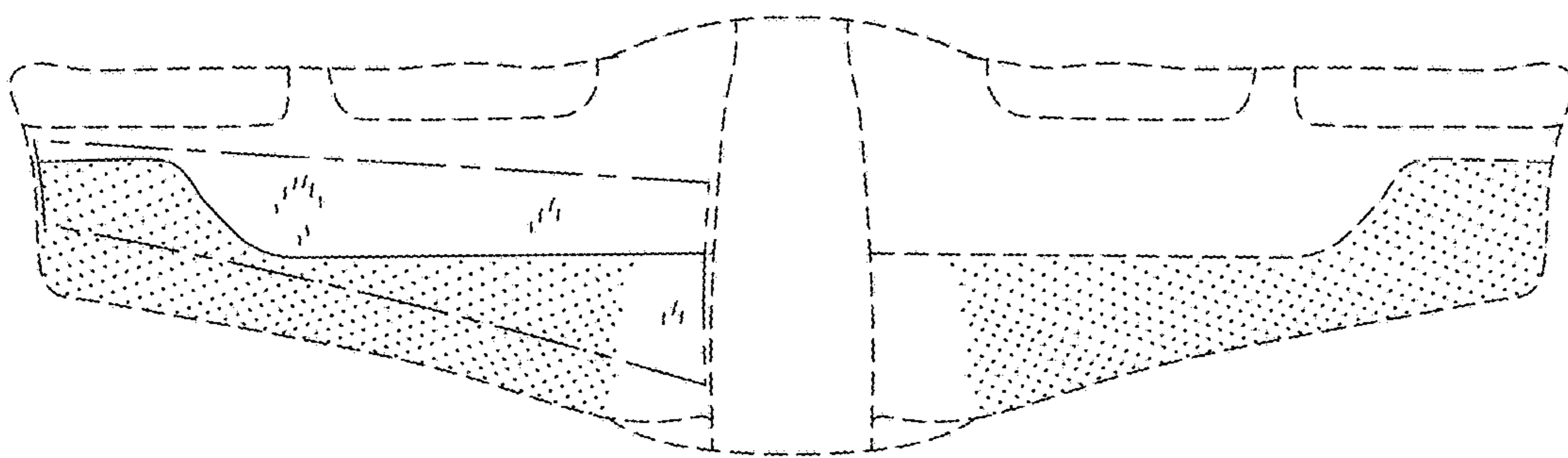

FIG. 16.

UNITED STATES PATENT AND TRADEMARK OFFICE
CERTIFICATE OF CORRECTION

PATENT NO. : D795,534 S
APPLICATION NO. : 29/546199
DATED : August 29, 2017
INVENTOR(S) : Donovan Harris

Page 1 of 1

It is certified that error appears in the above-identified patent and that said Letters Patent is hereby corrected as shown below:

In the Description:

Column 2 Line 20: "15 of FIG. 10; and," should read --15 of FIG. 10; and--

Signed and Sealed this
Twenty-fourth Day of October, 2017



Joseph Matal

*Performing the Functions and Duties of the
Under Secretary of Commerce for Intellectual Property and
Director of the United States Patent and Trademark Office*