

US00D795458S

(12) **United States Design Patent**  
**Marshall**

(10) **Patent No.:** **US D795,458 S**

(45) **Date of Patent:** **\*\* Aug. 22, 2017**

(54) **WINDOW COMPONENT EXTRUSION**

(71) Applicant: **Chelsea Building Products, Inc.**,  
Oakmont, PA (US)

(72) Inventor: **Philip Marshall**, Pittsburgh, PA (US)

(73) Assignee: **Chelsea Building Products, Inc.**,  
Oakmont, PA (US)

(\*\*) Term: **15 Years**

(21) Appl. No.: **29/550,706**

(22) Filed: **Jan. 6, 2016**

(51) **LOC (10) Cl.** ..... **25-01**

(52) **U.S. Cl.**  
USPC ..... **D25/125**

(58) **Field of Classification Search**  
USPC .... D25/47.1, 48.2, 48.3, 48.7, 60, 119, 120,  
D25/124, 125, 164; 49/DIG. 2, 409, 425,  
49/501, 504; 52/204.1, 204.5, 204.51,  
52/207, 656.5, 656.6, 656.2  
CPC ..... E06B 1/702; E06B 3/44; Y10T 29/49616  
See application file for complete search history.

(56) **References Cited**

**U.S. PATENT DOCUMENTS**

D324,919 S	*	3/1992	Dallaire	.....	D25/124
D335,712 S	*	5/1993	Cole	.....	D25/124
D461,013 S		7/2002	Marshall		
D461,014 S		7/2002	Marshall		
D619,729 S	*	7/2010	Bernier	.....	D25/124
D713,555 S		9/2014	Stankay et al.		
D713,556 S		9/2014	Stankay		
D713,557 S		9/2014	Stankay		
D713,558 S		9/2014	Stankay et al.		
D716,968 S		11/2014	Stankay		
D729,947 S		5/2015	Stankay		
D729,948 S		5/2015	Stankay		
D736,956 S	*	8/2015	Chaney	.....	D25/124
D736,957 S	*	8/2015	Chaney	.....	D25/124

D740,445 S	*	10/2015	Chaney	.....	D25/124
D740,446 S	*	10/2015	Chaney	.....	D25/124
D759,845 S	*	6/2016	Marshall	.....	D25/124
D759,846 S	*	6/2016	Marshall	.....	D25/124
D759,847 S	*	6/2016	Marshall	.....	D25/124
D759,848 S	*	6/2016	Marshall	.....	D25/124
D759,849 S	*	6/2016	Marshall	.....	D25/124
D759,850 S	*	6/2016	Marshall	.....	D25/124
D769,467 S	*	10/2016	Roberts	.....	D25/124

\* cited by examiner

*Primary Examiner* — Susan Bennett Hattan

*Assistant Examiner* — Leanne Was-Englehart

(74) *Attorney, Agent, or Firm* — Drinker Biddle & Reath LLP

(57) **CLAIM**

The ornamental design for a window component extrusion, as shown and described.

**DESCRIPTION**

FIG. 1 is a perspective view of a window component extrusion according to the present invention.

FIG. 2 is a right side view of the window component extrusion of FIG. 1.

FIG. 3 is a left side view of the window component extrusion of FIG. 1.

FIG. 4 is a front view of the window component extrusion of FIG. 1.

FIG. 5 is a rear view of the window component extrusion of FIG. 1.

FIG. 6 is a top view of the window component extrusion of FIG. 1; and,

FIG. 7 is a bottom view of the window component extrusion of FIG. 1.

The window component extrusion is shown with two parallel dash-dot break lines that represent the bounds of the Claim. The appearance of any portion of the article between the break lines forms no part of the claimed design.

**1 Claim, 4 Drawing Sheets**

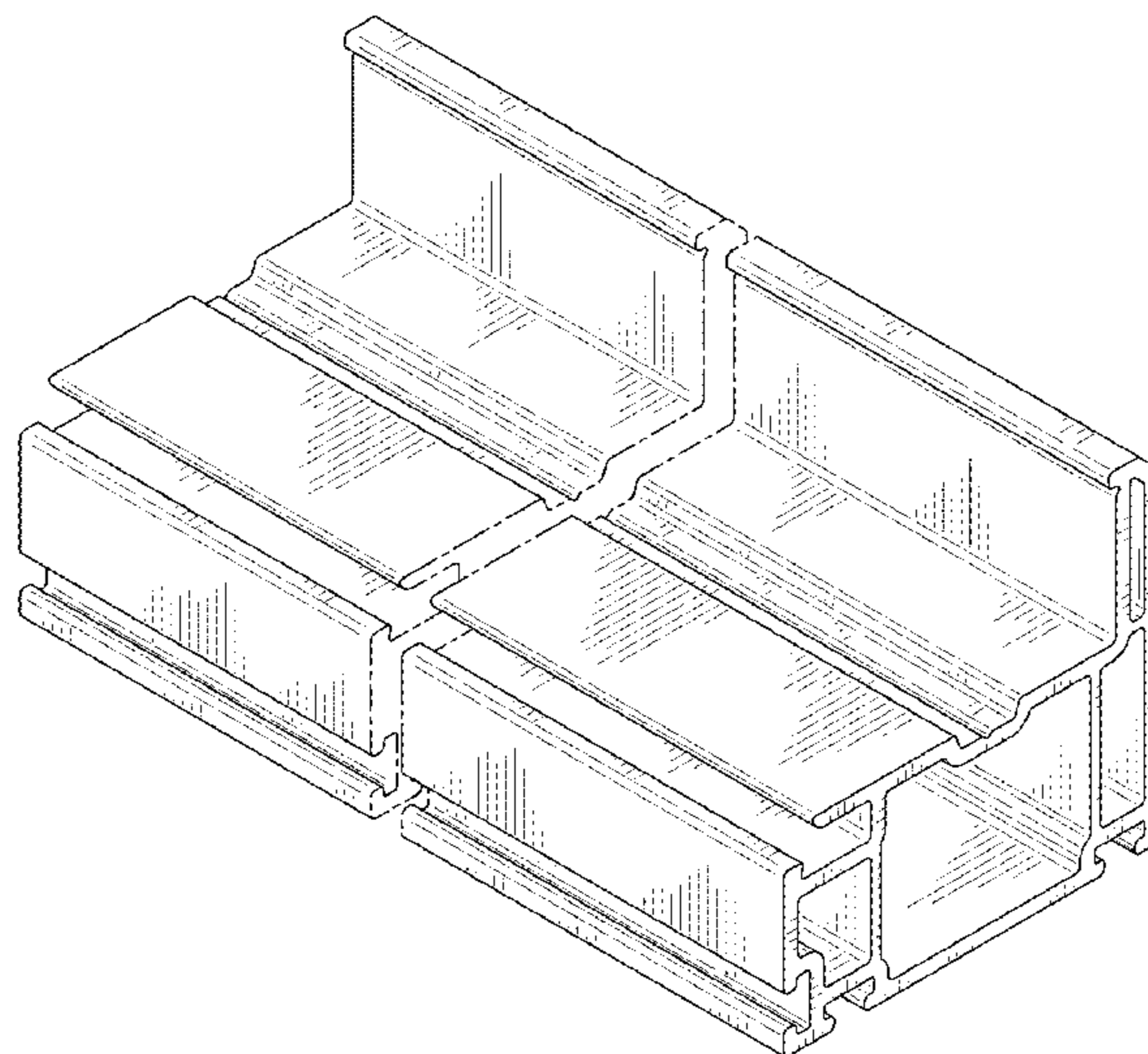

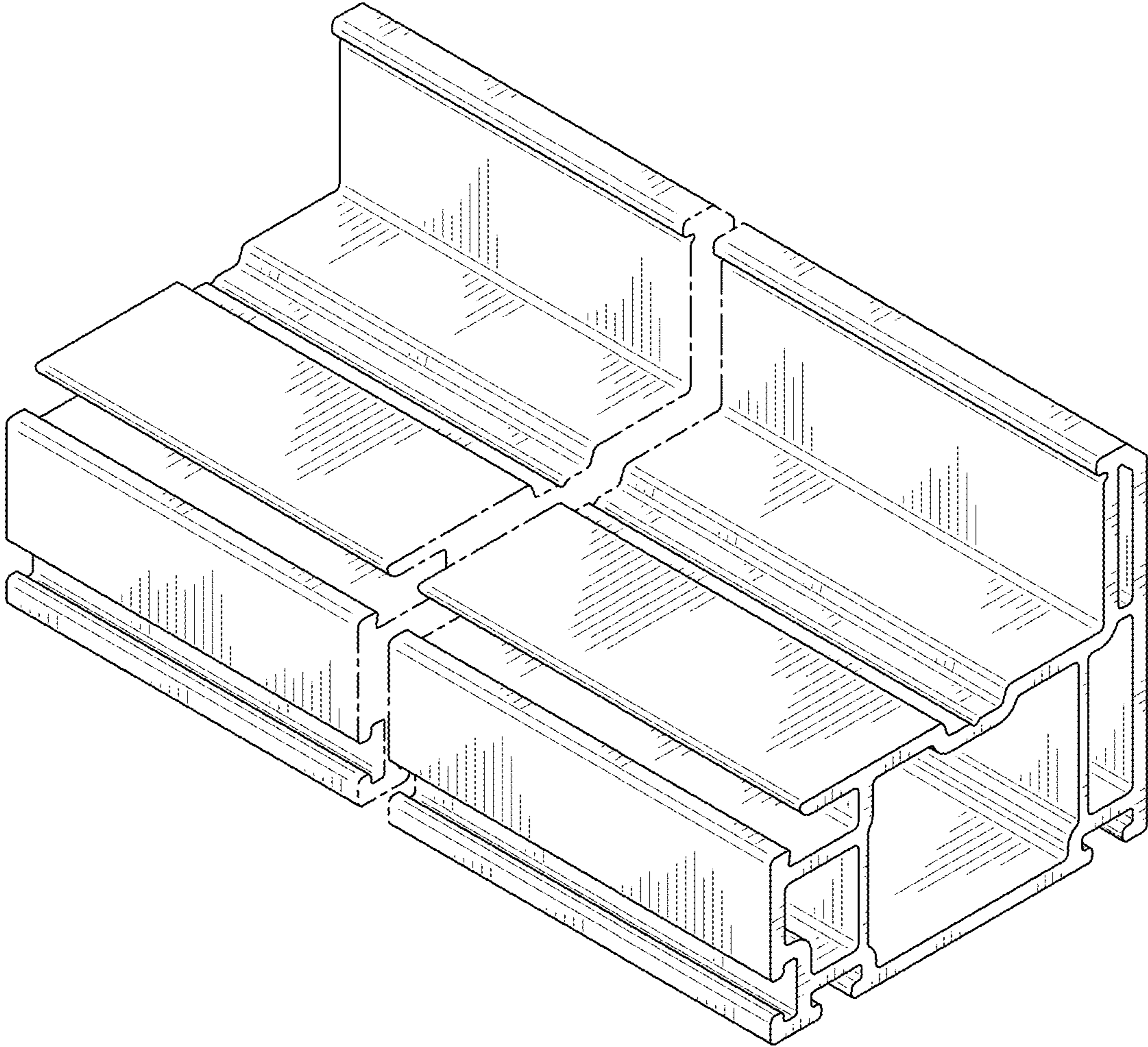

FIG. 1

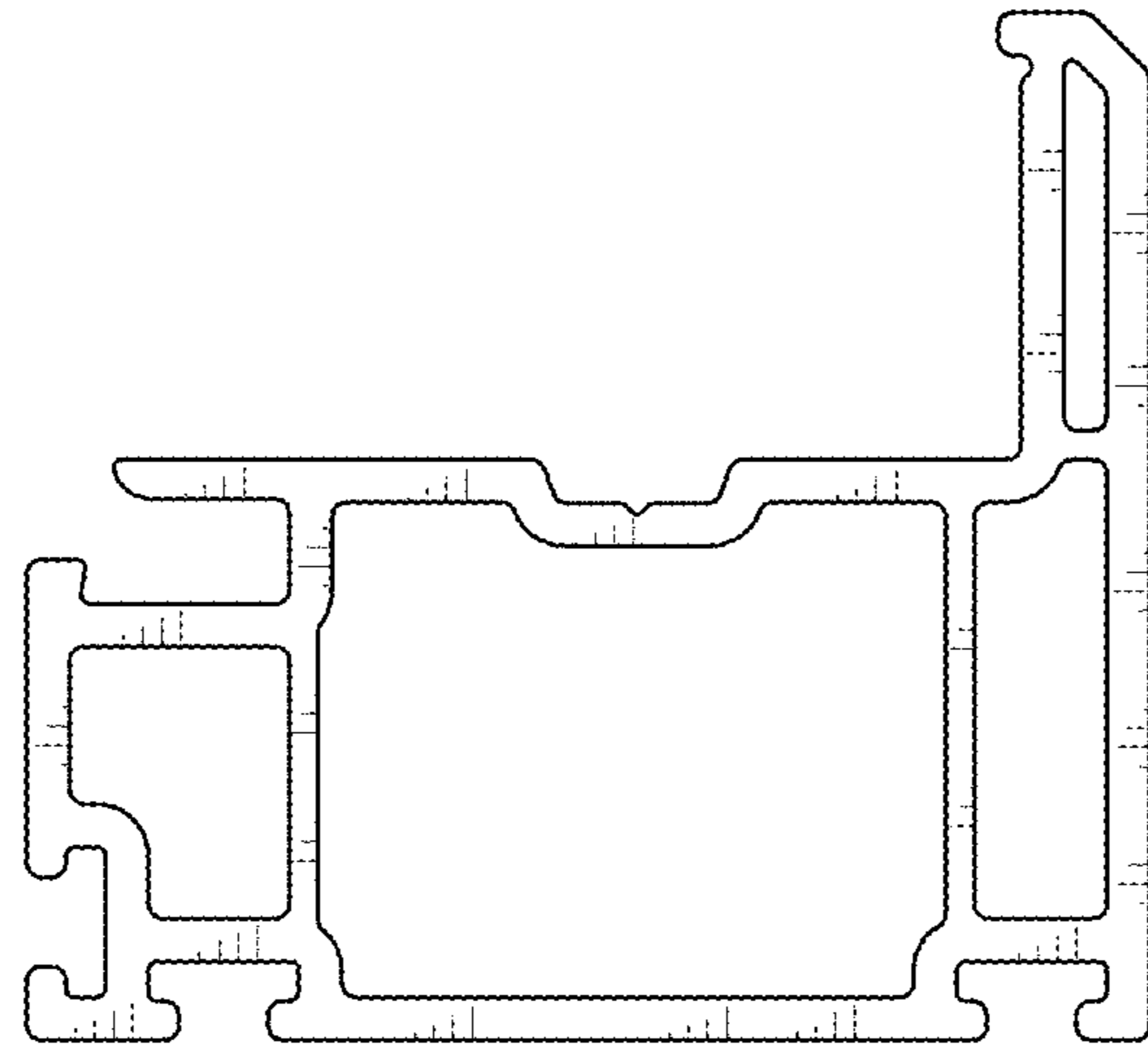

FIG. 2

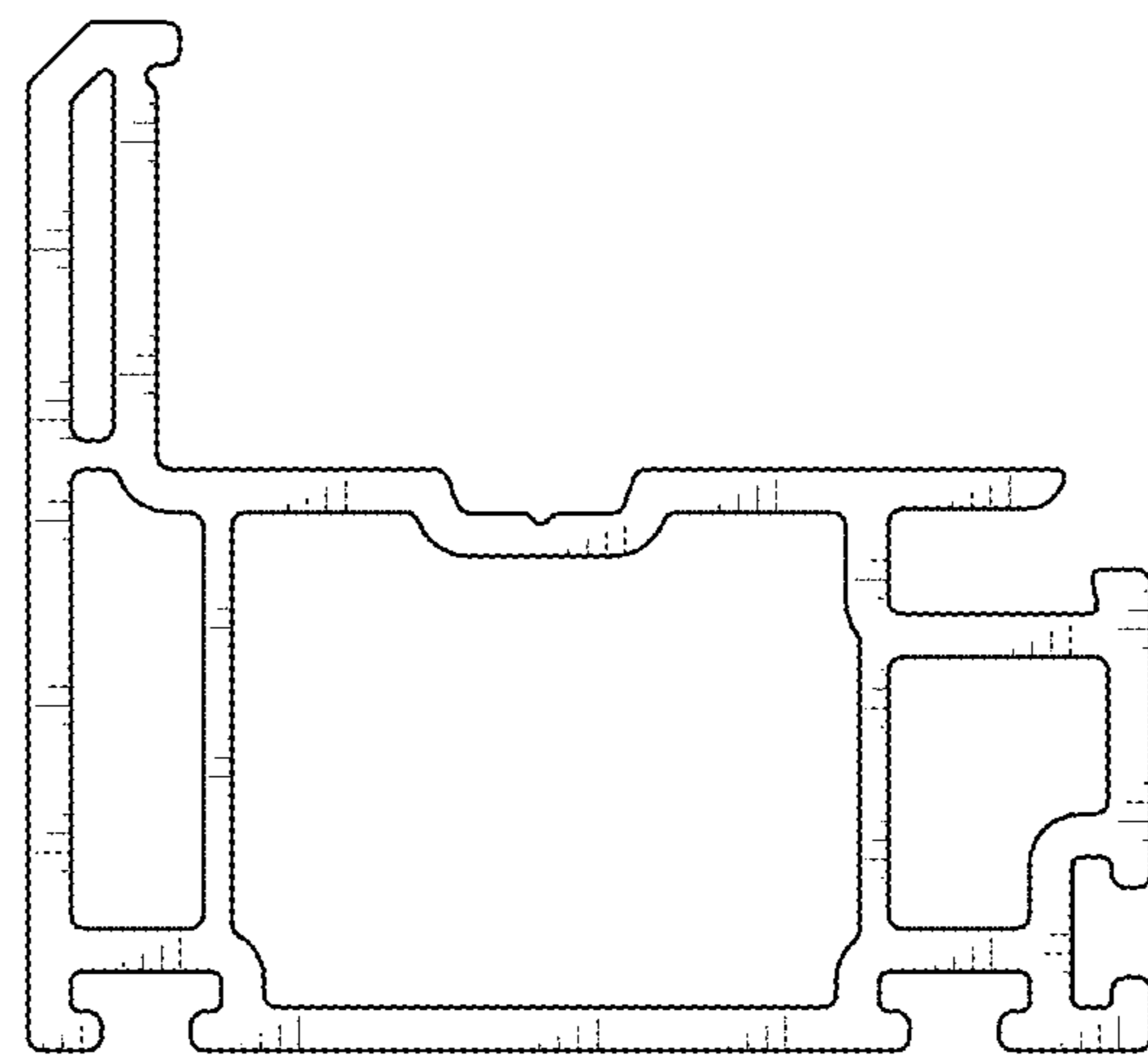

FIG. 3

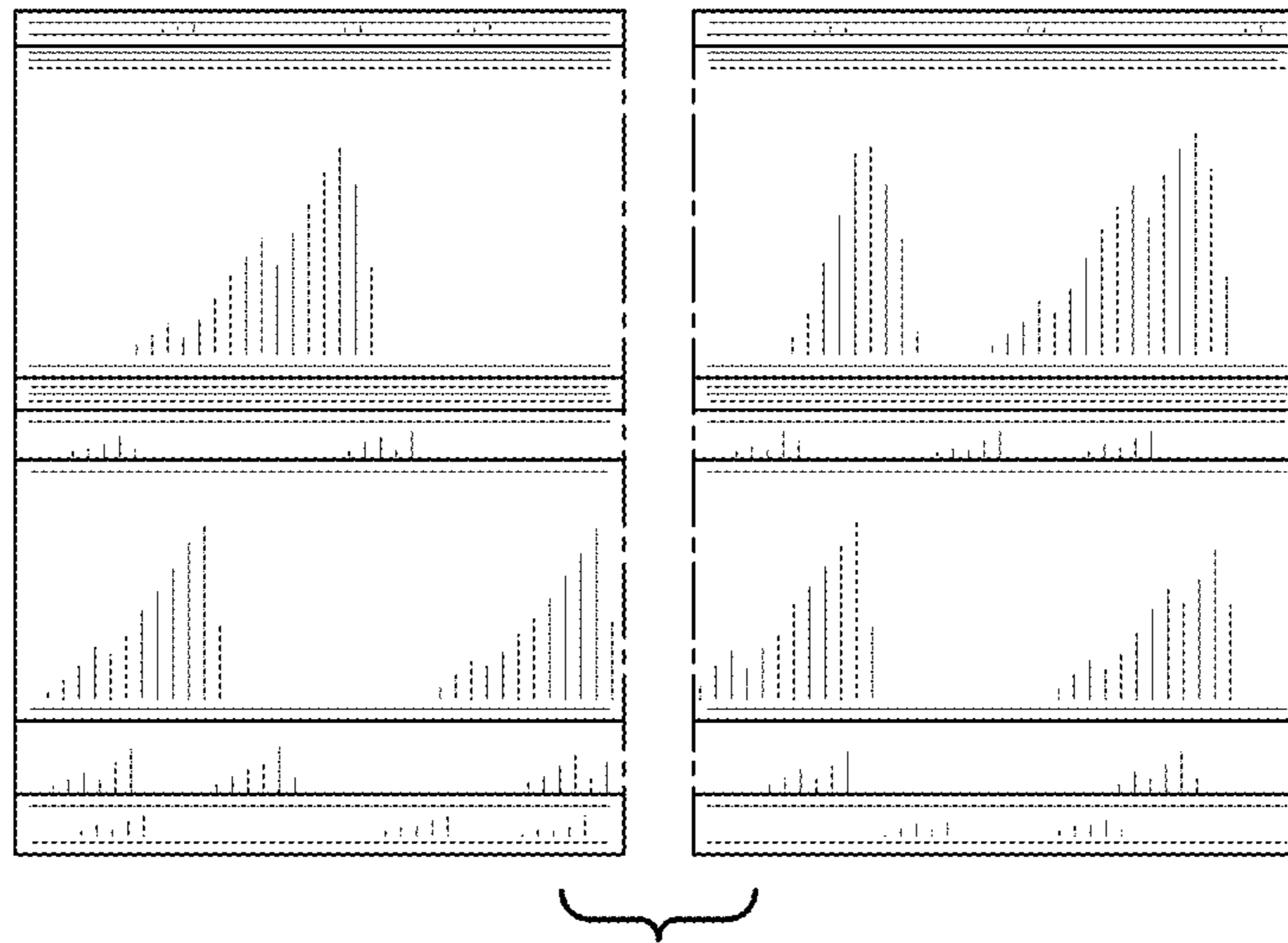

FIG. 4

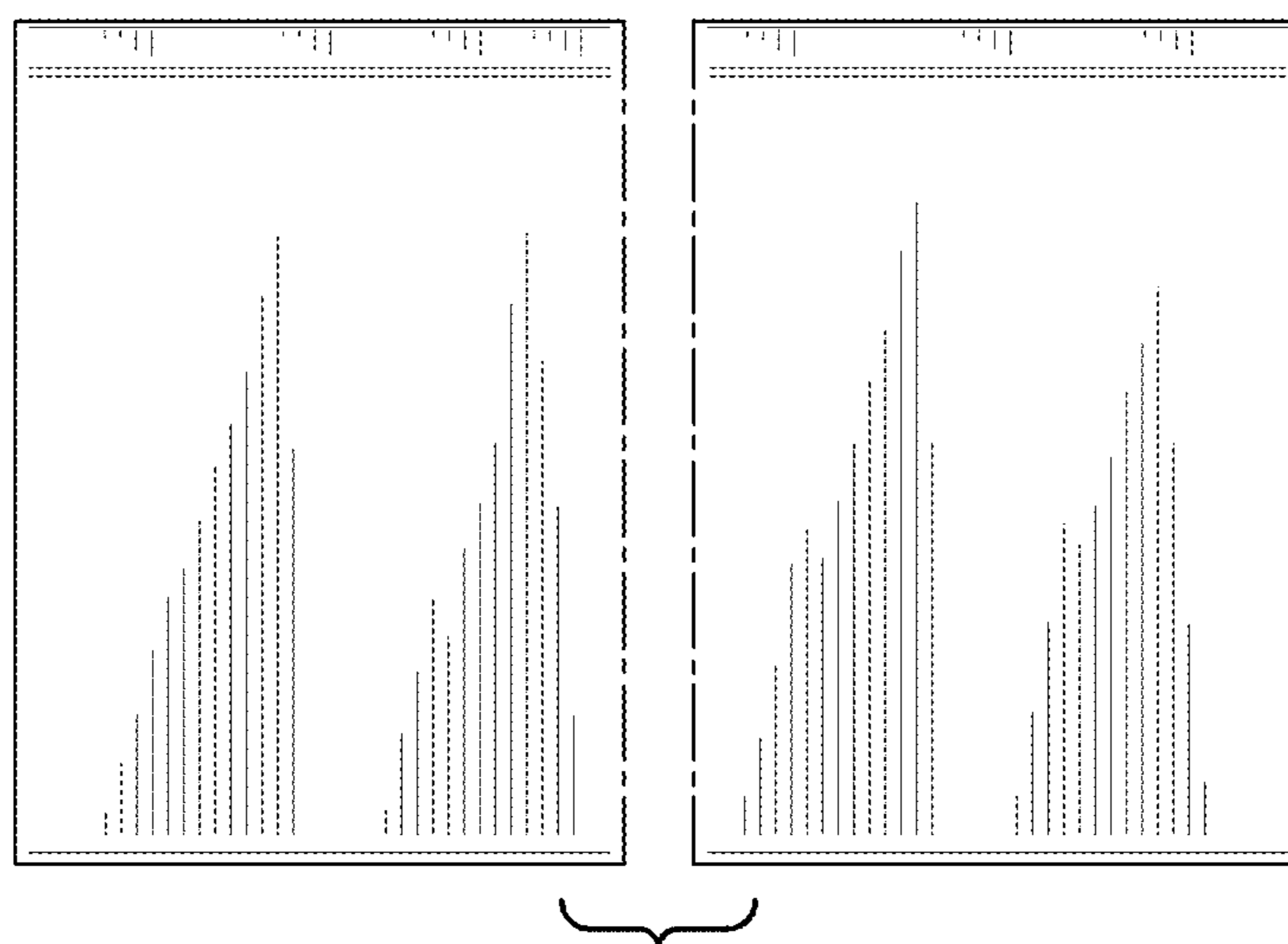

FIG. 5

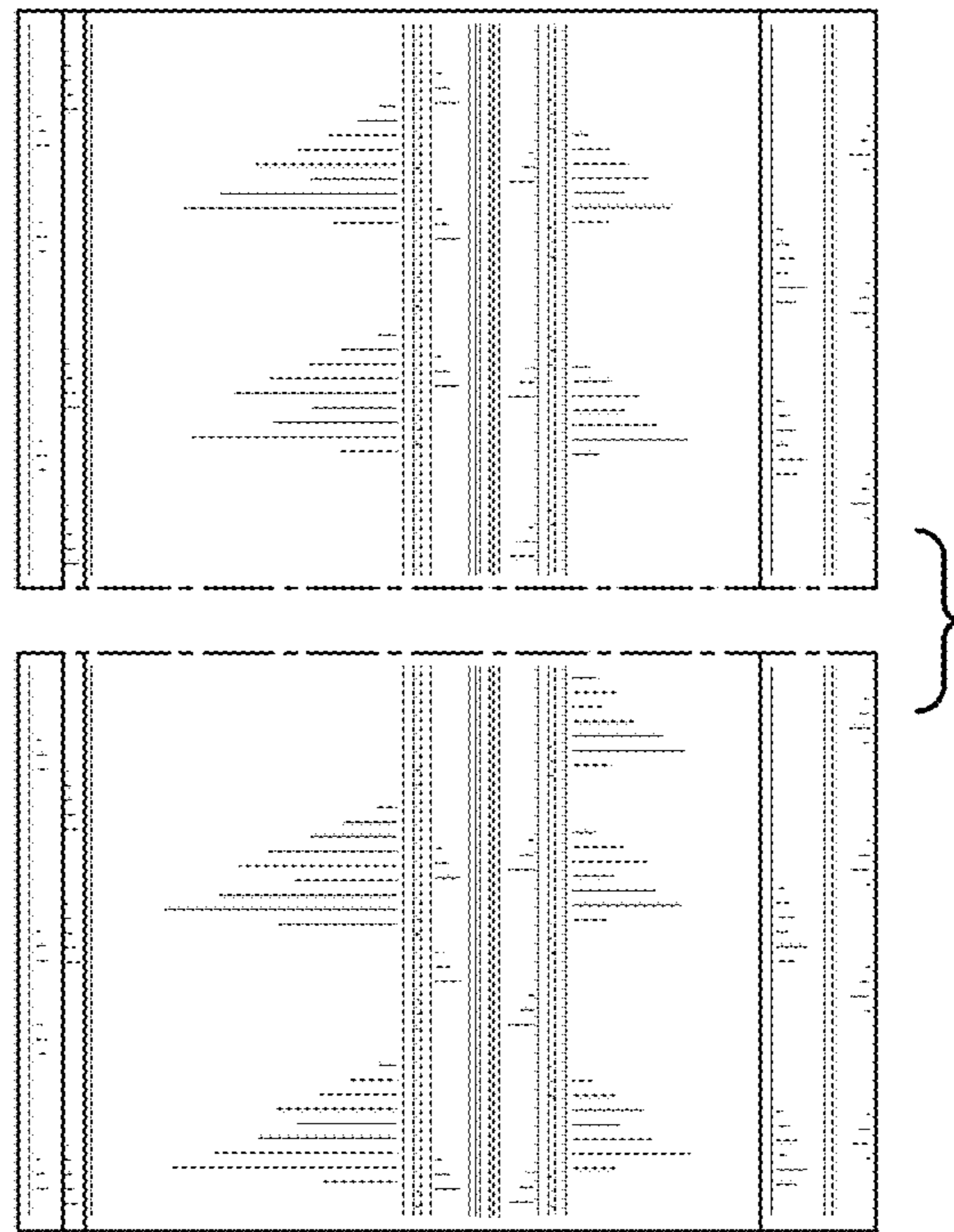

FIG. 6

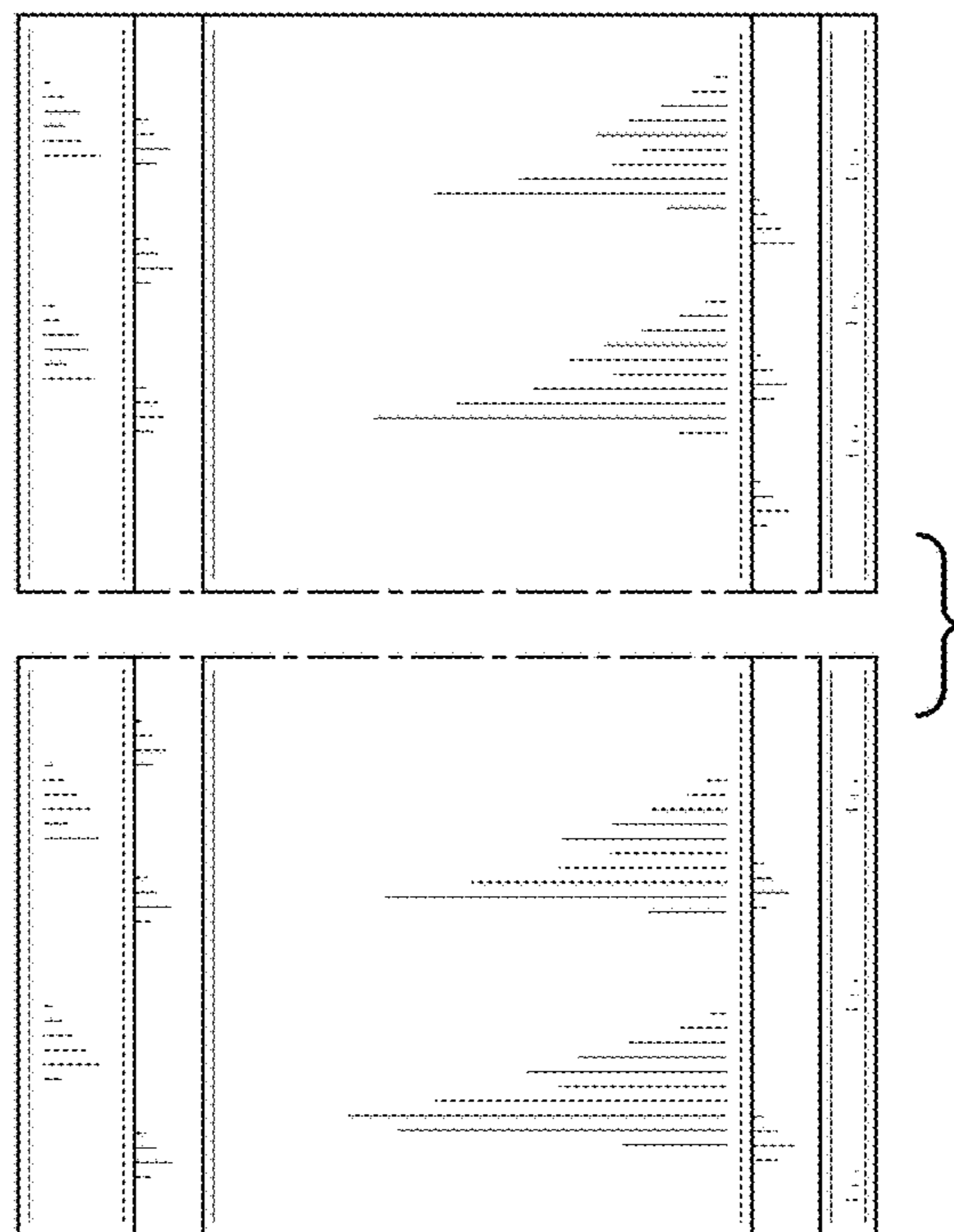

FIG. 7