



US00D795431S

(12) **United States Design Patent** (10) **Patent No.:** **US D795,431 S**
Way et al. (45) **Date of Patent:** **** Aug. 22, 2017**

(54) **DENTAL VIBRATION DEVICE**
(71) Applicant: **Advanced Orthodontics and Education Association, LLC**, Ossining, NY (US)
(72) Inventors: **Bryce A Way**, San Jose, CA (US); **Richard Johnson**, Briarcliff Manor, NY (US)
(73) Assignee: **Advanced Orthodontics and Education Association, LLC**, Ossining, NY (US)
(**) Term: **15 Years**
(21) Appl. No.: **29/601,359**
(22) Filed: **Apr. 21, 2017**
(51) **LOC (10) Cl.** **24-02**
(52) **U.S. Cl.**
USPC **D24/152; D24/180**
(58) **Field of Classification Search**
USPC D24/152, 156, 176, 180-181; D29/108
CPC .. A61C 7/008; A61C 7/08; A61C 7/00; A61C 7/002; A61C 7/06; A61C 7/36; A61C 9/0006; A61H 23/00; A61H 2205/026; A61F 2002/2864
See application file for complete search history.

(56) **References Cited**
U.S. PATENT DOCUMENTS
D215,685 S 10/1969 Helmer
D257,790 S 1/1981 Kesling
D281,532 S 11/1985 Weissman
5,030,098 A * 7/1991 Branford A61H 23/00
433/215
5,752,826 A * 5/1998 Andreiko A61C 9/0006
433/37
D408,919 S 4/1999 Cooley

6,045,359 A * 4/2000 Tucker A61C 9/0006
433/37
D425,295 S 5/2000 Borja et al.
6,302,690 B1 * 10/2001 Brandhorst A61C 9/0006
433/37
D526,093 S 8/2006 Manzo et al.
D528,208 S 9/2006 Moriyama
D538,926 S 3/2007 Jeong et al.
D582,559 S 12/2008 Khawaled et al.
D593,714 S 6/2009 Hirshberg
D632,395 S 2/2011 Massad
D650,986 S 12/2011 Brady et al.
D655,816 S 3/2012 Llop et al.
D661,806 S 6/2012 Khawaled et al.
D663,485 S 7/2012 Turkbass et al.
D663,943 S 7/2012 Walsh et al.
D677,007 S 2/2013 Bancroft
D683,455 S 5/2013 Slominski
D686,733 S 7/2013 Marumori et al.
D706,937 S 6/2014 Suga et al.

(Continued)

Primary Examiner — Wan Laymon
(74) *Attorney, Agent, or Firm* — Finnegan, Henderson, Farabow, Garrett & Dunner, L.L.P.

(57) **CLAIM**
The ornamental design for a dental vibration device, as shown and described.

DESCRIPTION

FIG. 1 is a front, right, top perspective view of a dental vibration device showing our new design; FIG. 2 is a top plan view thereof; FIG. 3 is a bottom plan view thereof; FIG. 4 is a rear elevation view thereof; FIG. 5 is a front elevation view thereof; and, FIG. 6 is a right side view thereof, with the left side view being a mirror image thereof. The broken lines shown in the drawings depict portions of the dental vibration device that form no part of the claimed design.

1 Claim, 6 Drawing Sheets

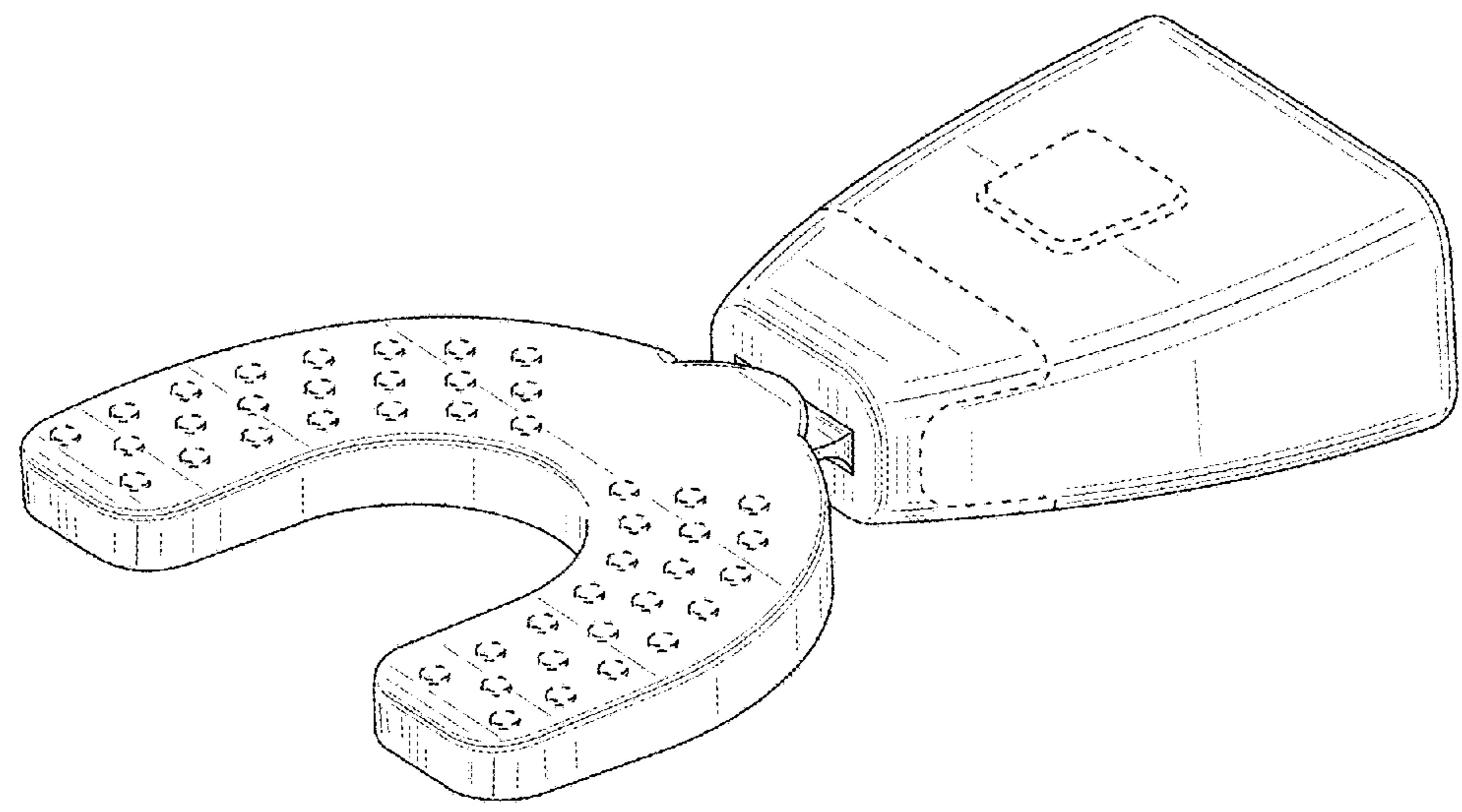

(56)

References Cited

U.S. PATENT DOCUMENTS

D713,531 S	9/2014	Way et al.	
D719,266 S	12/2014	Goldstein	
D721,438 S	1/2015	Layzell	
D734,556 S	7/2015	Brett et al.	
D746,058 S	12/2015	Serell	
D747,607 S	1/2016	Serell	
9,370,405 B2 *	6/2016	Lowe	A61C 7/00
D760,889 S	7/2016	Evans et al.	
D764,061 S	8/2016	Furdui-Carr	
D765,255 S	8/2016	Levine	
D781,427 S	3/2017	Blank et al.	
9,662,183 B2 *	5/2017	Lowe	A61C 7/008
2008/0160473 A1 *	7/2008	Li	A61C 7/08 433/3
2013/0273490 A1 *	10/2013	Way	A61C 7/008 433/6

* cited by examiner

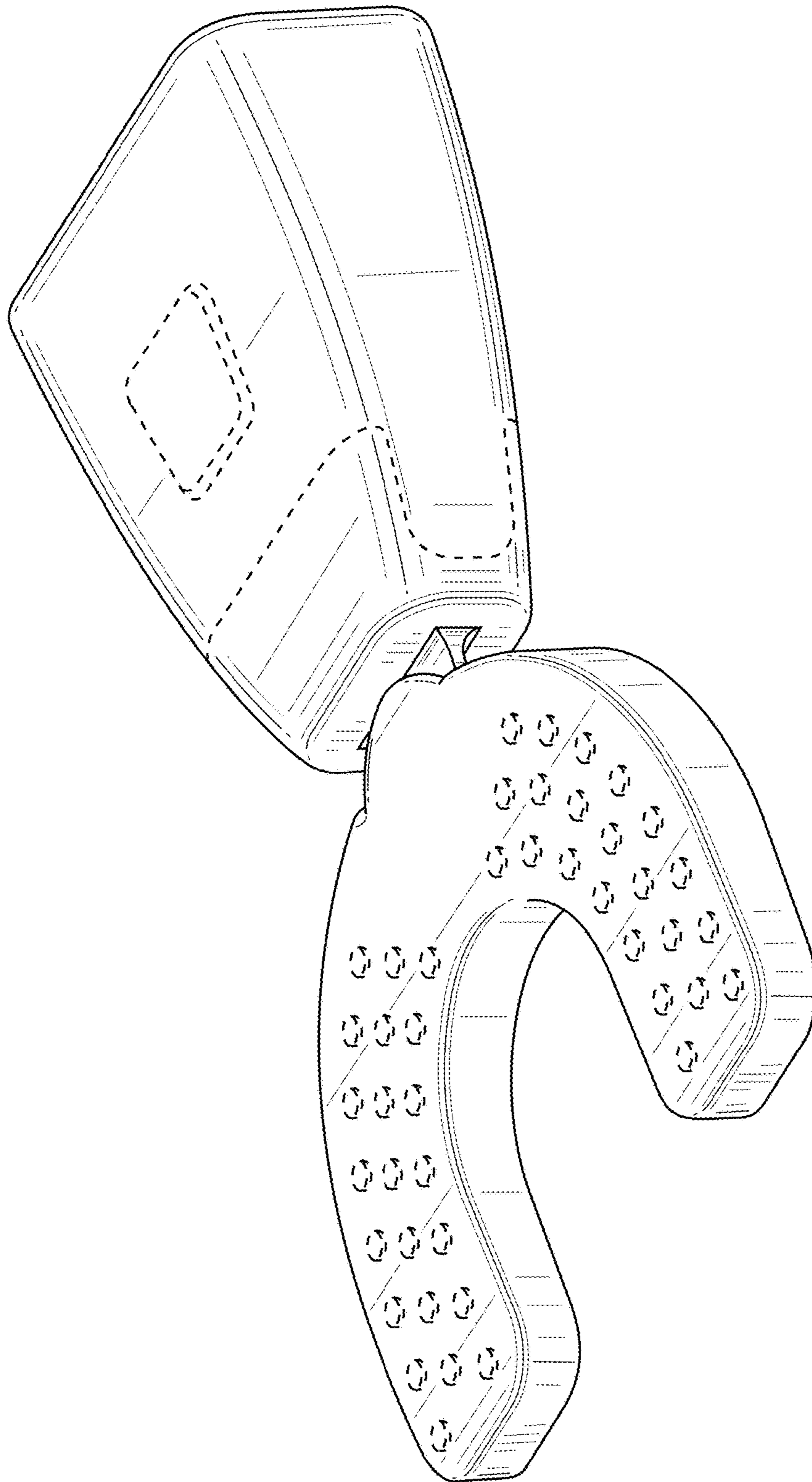

FIG. 1

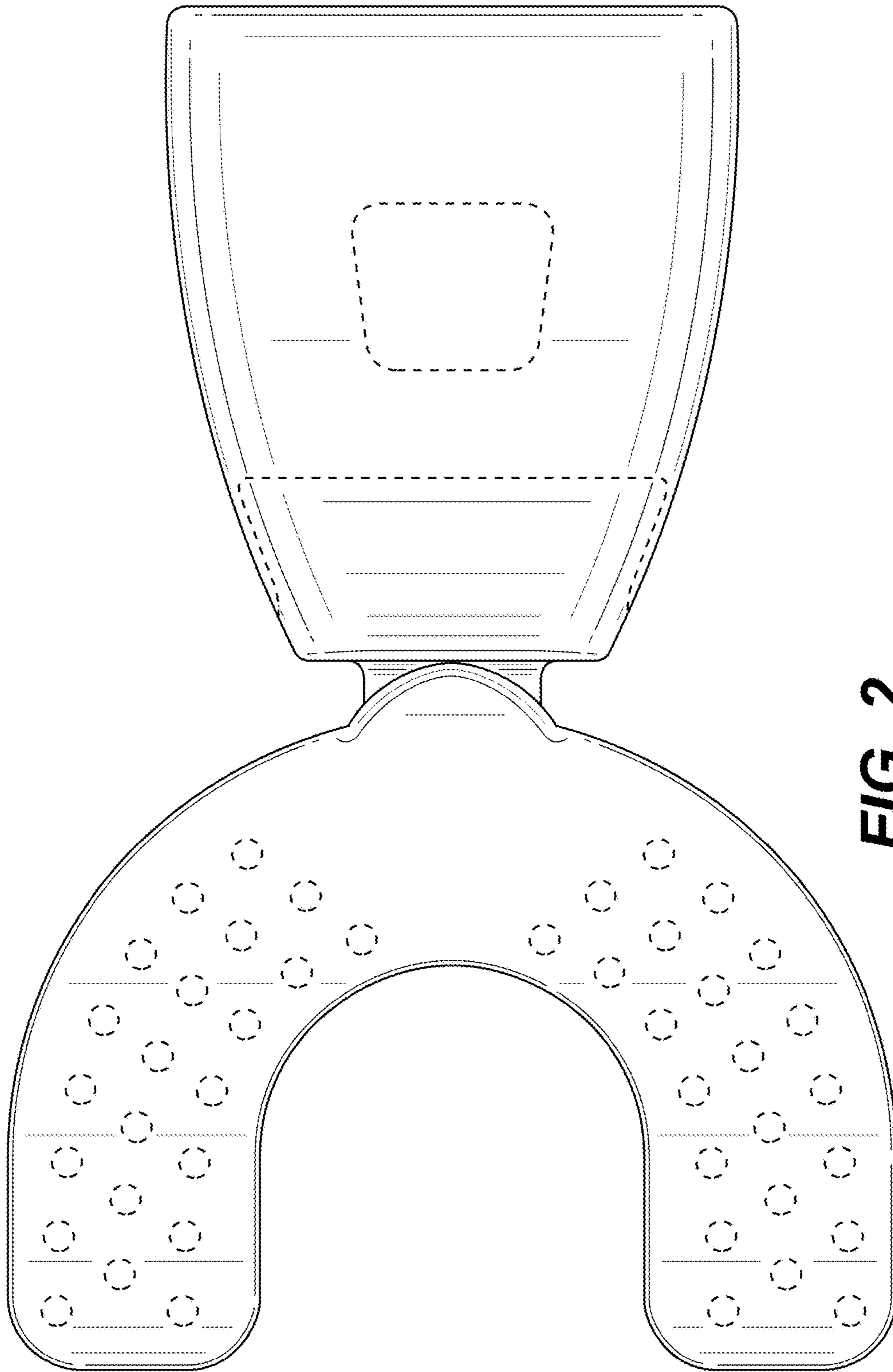

FIG. 2

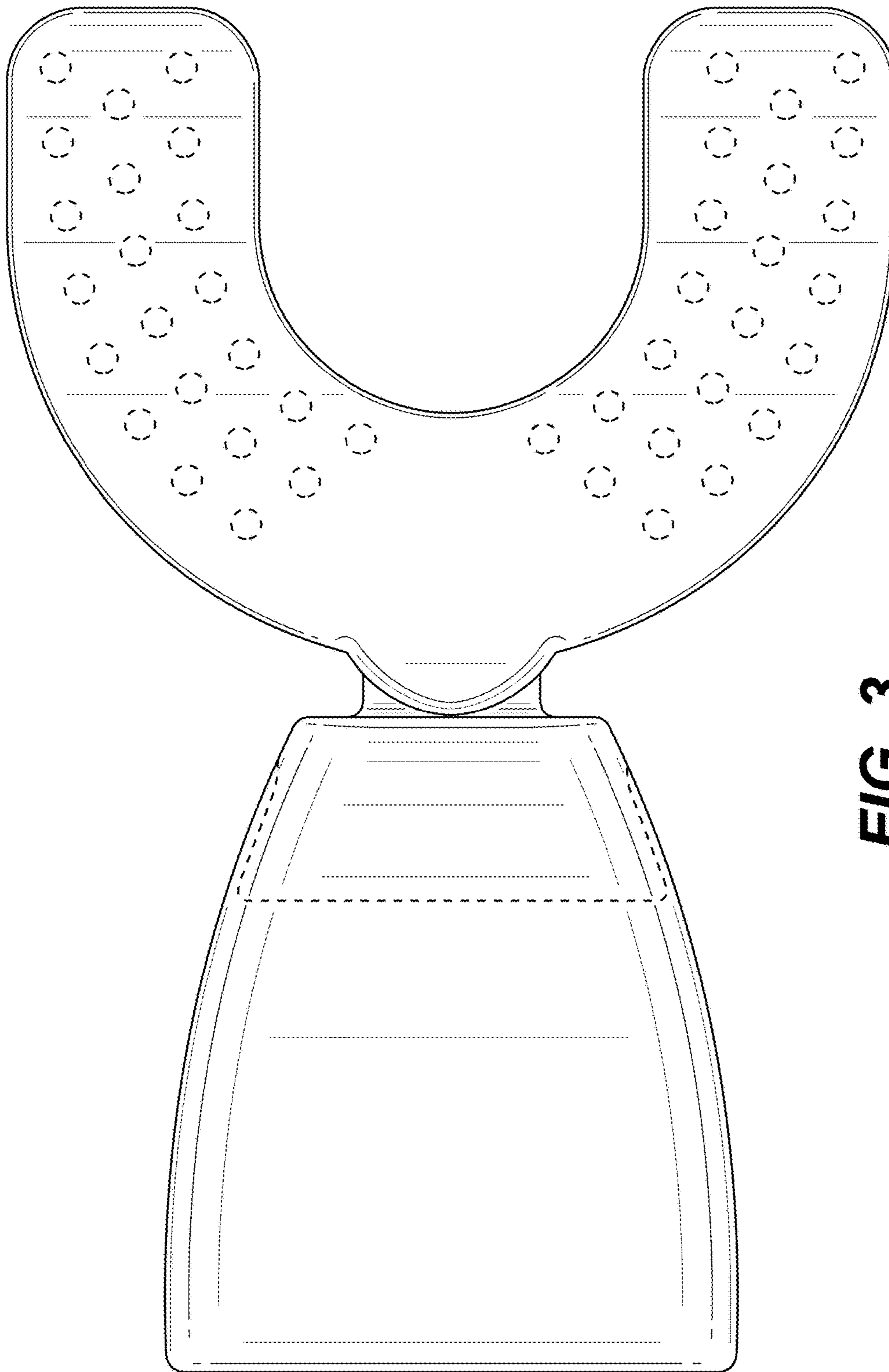

FIG. 3

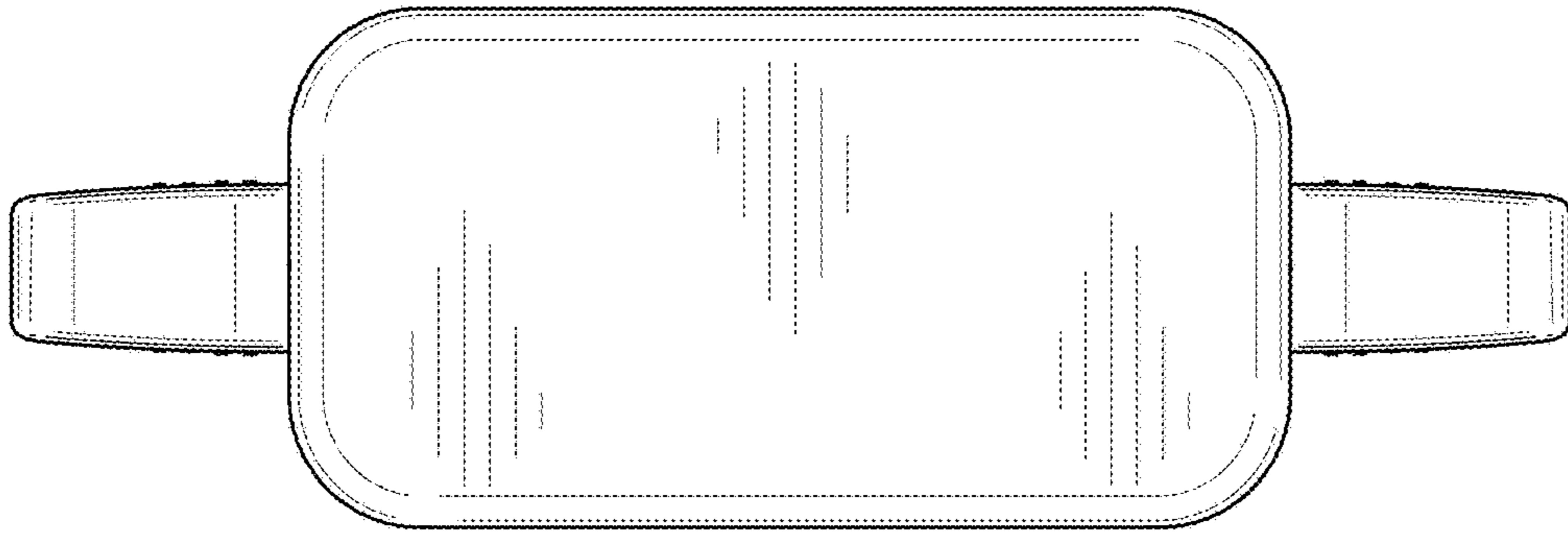

FIG. 4

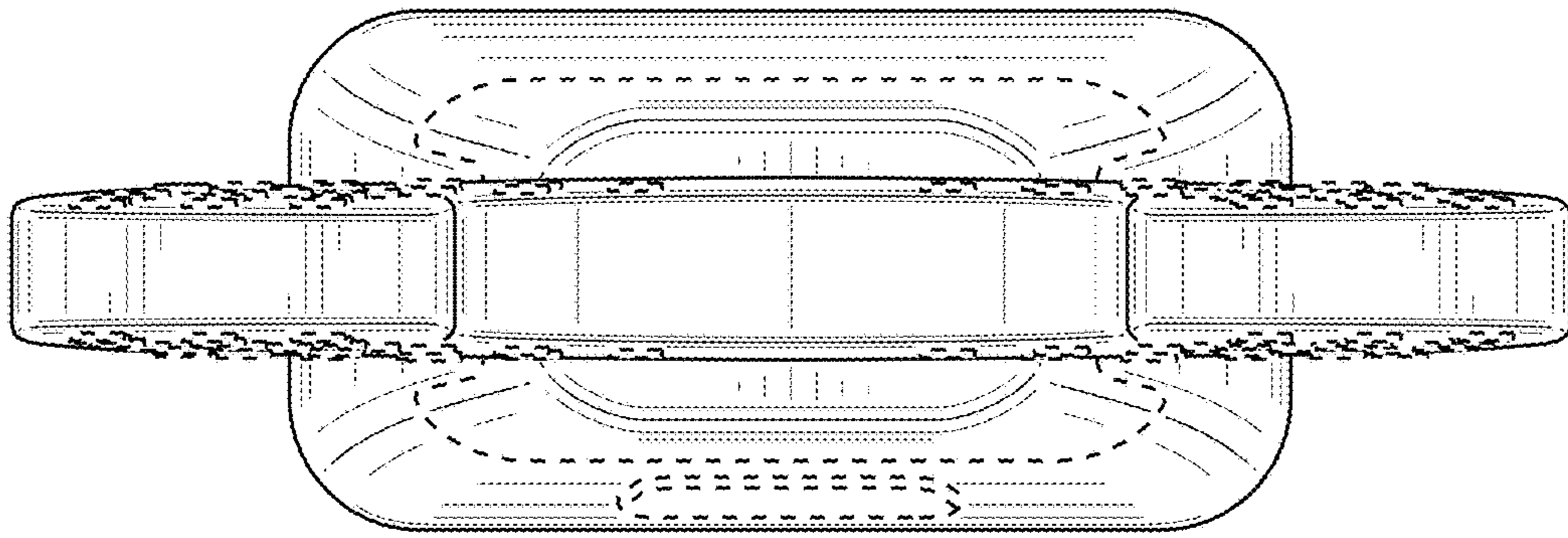

FIG. 5

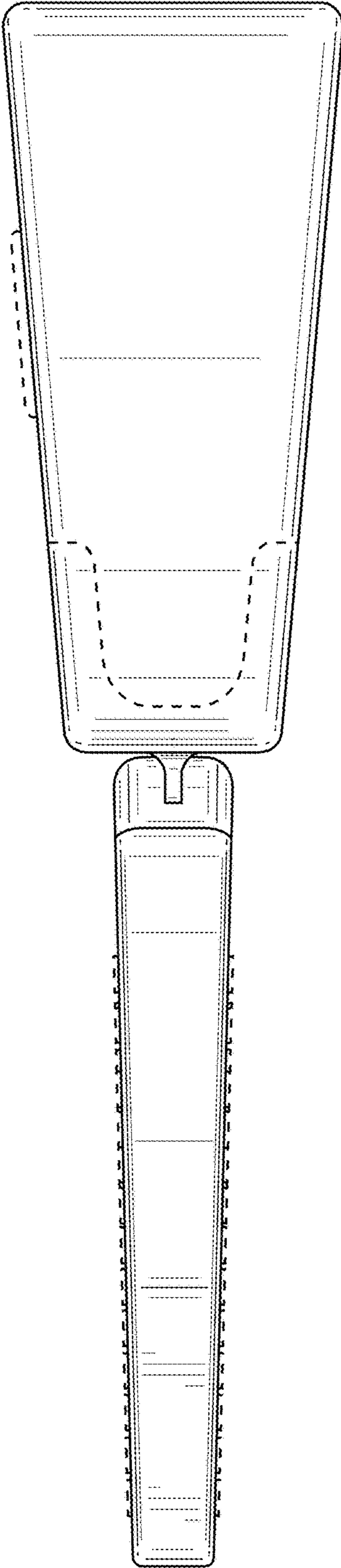

FIG. 6