



US00D795401S

(12) **United States Design Patent**  
**Marsden**

(10) **Patent No.:** **US D795,401 S**

(45) **Date of Patent:** **\*\* Aug. 22, 2017**

(54) **BATH POSITIONER**

(71) Applicant: **Andrew Marsden**, Hingham, MA (US)

(72) Inventor: **Andrew Marsden**, Hingham, MA (US)

(73) Assignee: **Elbee Pty Ltd.**, Bondi Junction (AU)

(\*\*) Term: **15 Years**

(21) Appl. No.: **29/537,464**

(22) Filed: **Aug. 26, 2015**

(51) **LOC (10) Cl.** ..... **23-02**

(52) **U.S. Cl.**  
USPC ..... **D23/278**

(58) **Field of Classification Search**  
USPC ..... D23/278, 304; D6/333  
CPC ..... A47K 3/024; A47K 3/074; A47K 3/127;  
A47K 3/304; A47K 3/064; A61G 7/0005  
See application file for complete search history.

(56) **References Cited**

**U.S. PATENT DOCUMENTS**

- D318,112 S \* 7/1991 Tempereau Jacques ..... D23/278
- 5,599,063 A \* 2/1997 Lister ..... A47K 3/127  
297/256.11
- D398,784 S \* 9/1998 Koehl ..... D23/278
- D404,473 S \* 1/1999 Allegre ..... D23/278
- D454,182 S \* 3/2002 Allison ..... D23/278
- D611,259 S \* 3/2010 Yeung ..... D6/333
- D670,088 S \* 11/2012 Wozniak ..... D6/333

\* cited by examiner

*Primary Examiner* — Robert Delehanty

(74) *Attorney, Agent, or Firm* — Wolf, Greenfield & Sacks, P.C.

(57) **CLAIM**

The ornamental design for a bath positioner, as shown and described.

**DESCRIPTION**

FIG. 1 illustrates a top, left, front isometric view of a bath positioner showing a first embodiment of my new design; FIG. 2 illustrates a top, right, front isometric view thereof; FIG. 3 illustrates a right side view thereof; FIG. 4 illustrates a left side view thereof; FIG. 5 illustrates a top, left, rear isometric view thereof; FIG. 6 illustrates a top, right, rear isometric view thereof; FIG. 7 illustrates a front left side elevational view thereof; FIG. 8 illustrates a front right side elevational view thereof; FIG. 9 illustrates a bottom, left, rear isometric view thereof; FIG. 10 illustrates a bottom, right, rear isometric view thereof; FIG. 11 illustrates a right side bottom view thereof; FIG. 12 illustrates a left side bottom view thereof; FIG. 13 illustrates a top view thereof; FIG. 14 illustrates a bottom view thereof; FIG. 15 illustrates a rear view thereof; FIG. 16 illustrates a top rear view thereof; FIG. 17 illustrates a bottom rear view thereof; FIG. 18 illustrates a front view thereof; FIG. 19 illustrates a top front view thereof; FIG. 20 illustrates a bottom front view thereof; FIG. 21 illustrates a top view of a bath positioner with attachment suction cups according to a second embodiment thereof; FIG. 22 illustrates a bottom view of FIG. 21; FIG. 23 illustrates a right side view of FIG. 21; FIG. 24 illustrates a front view of FIG. 21; and, FIG. 25 illustrates a rear view of FIG. 2.

**1 Claim, 25 Drawing Sheets**

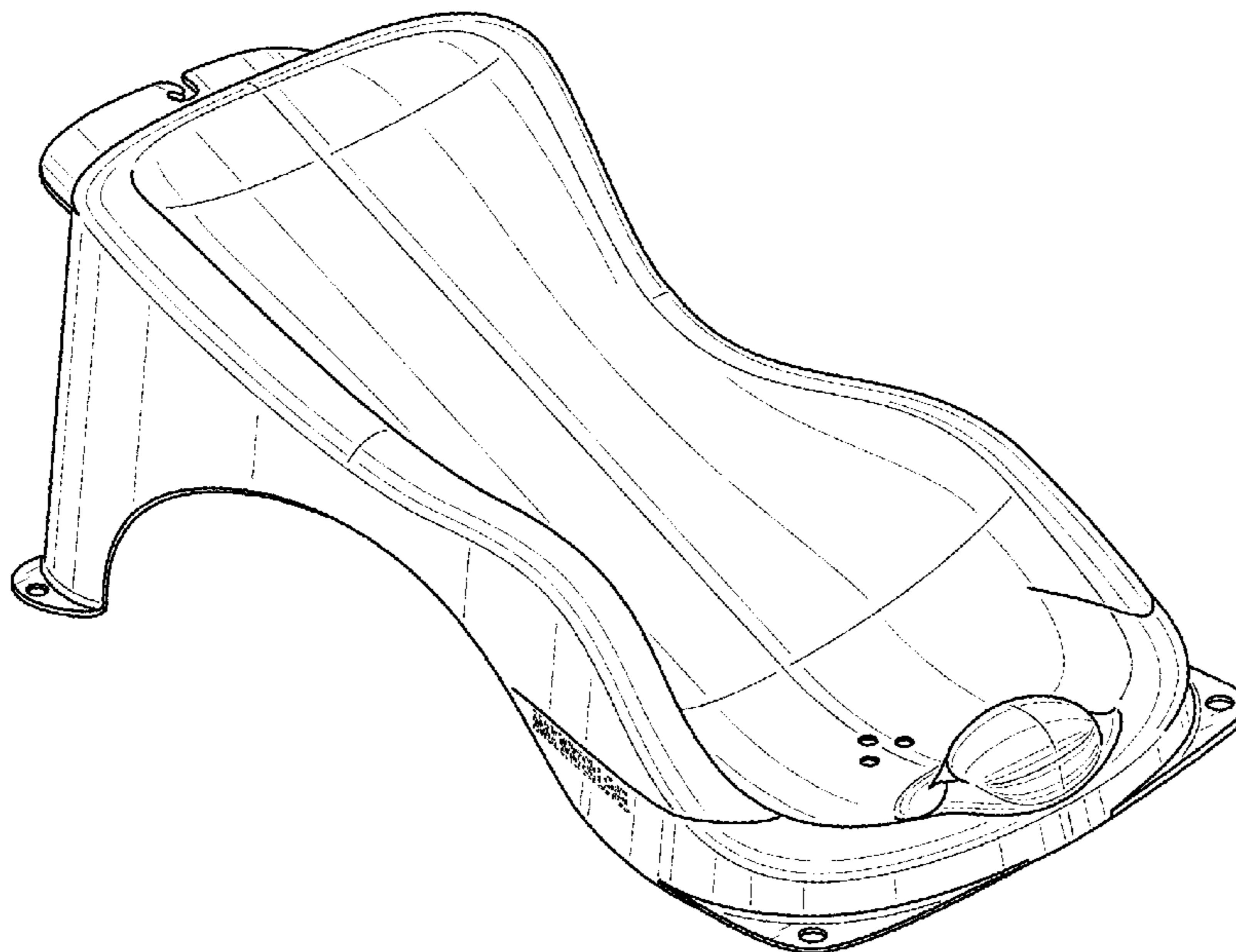

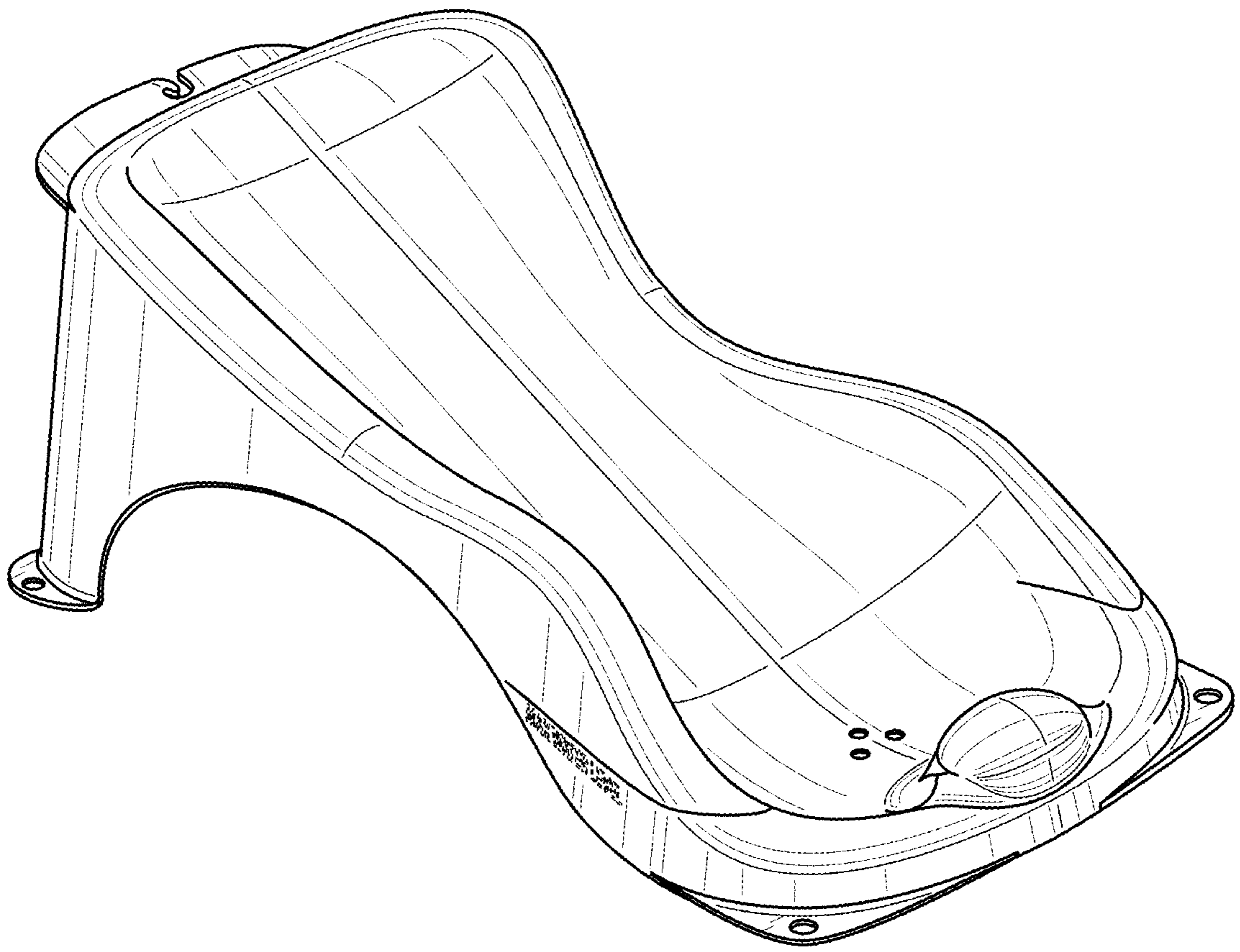

FIG. 1

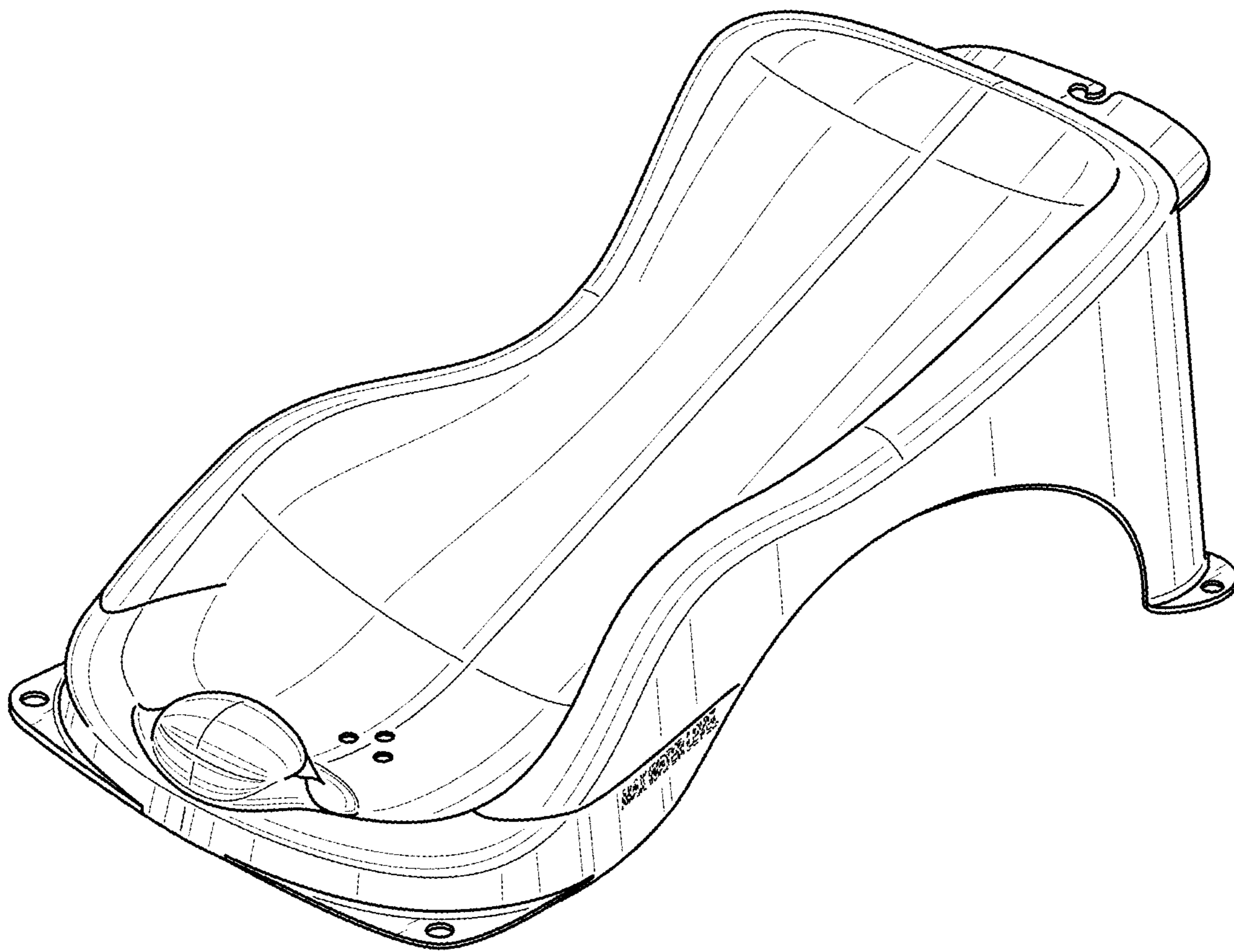

FIG. 2

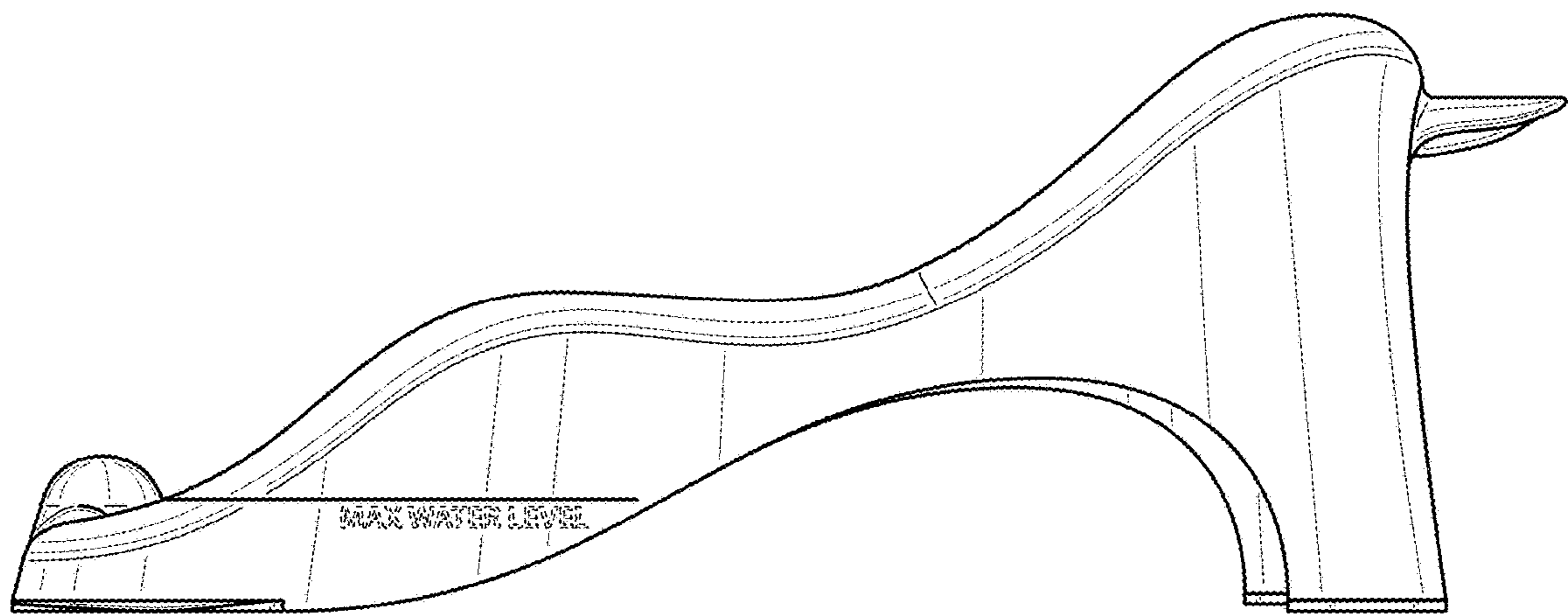

FIG. 3



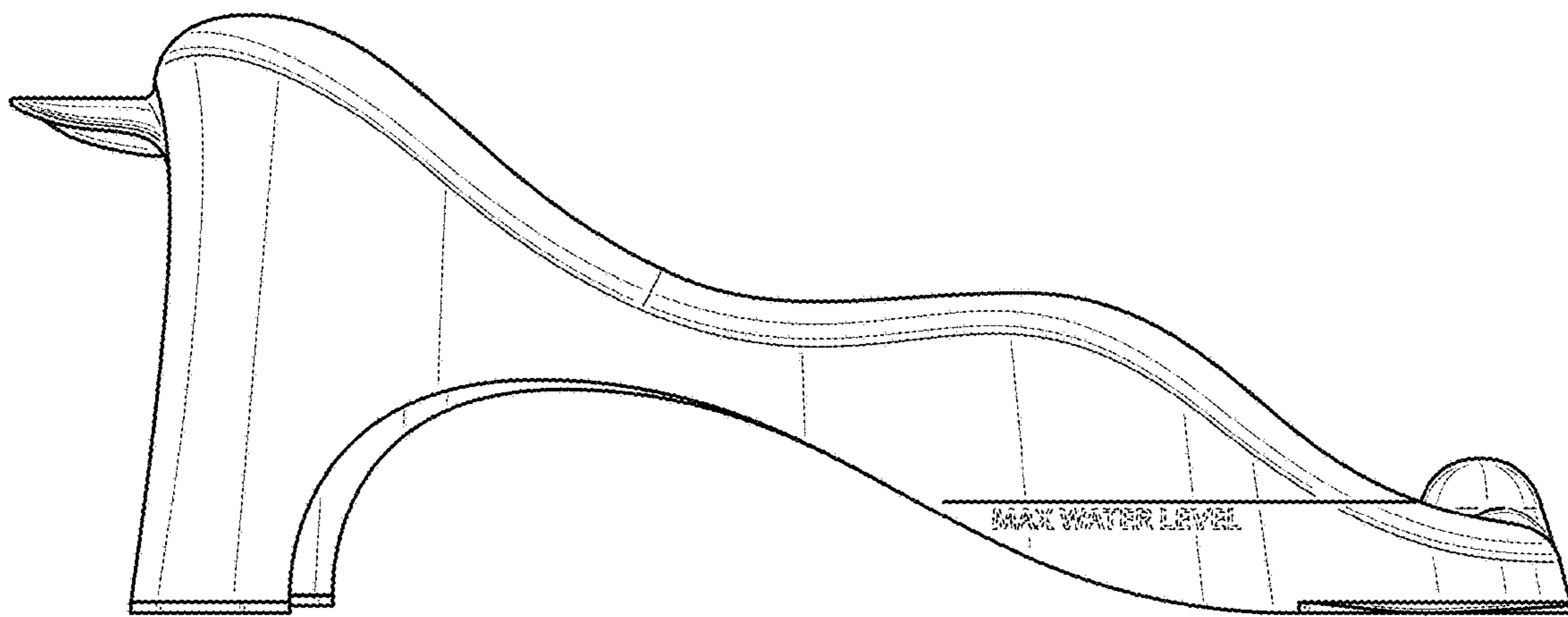

FIG. 4

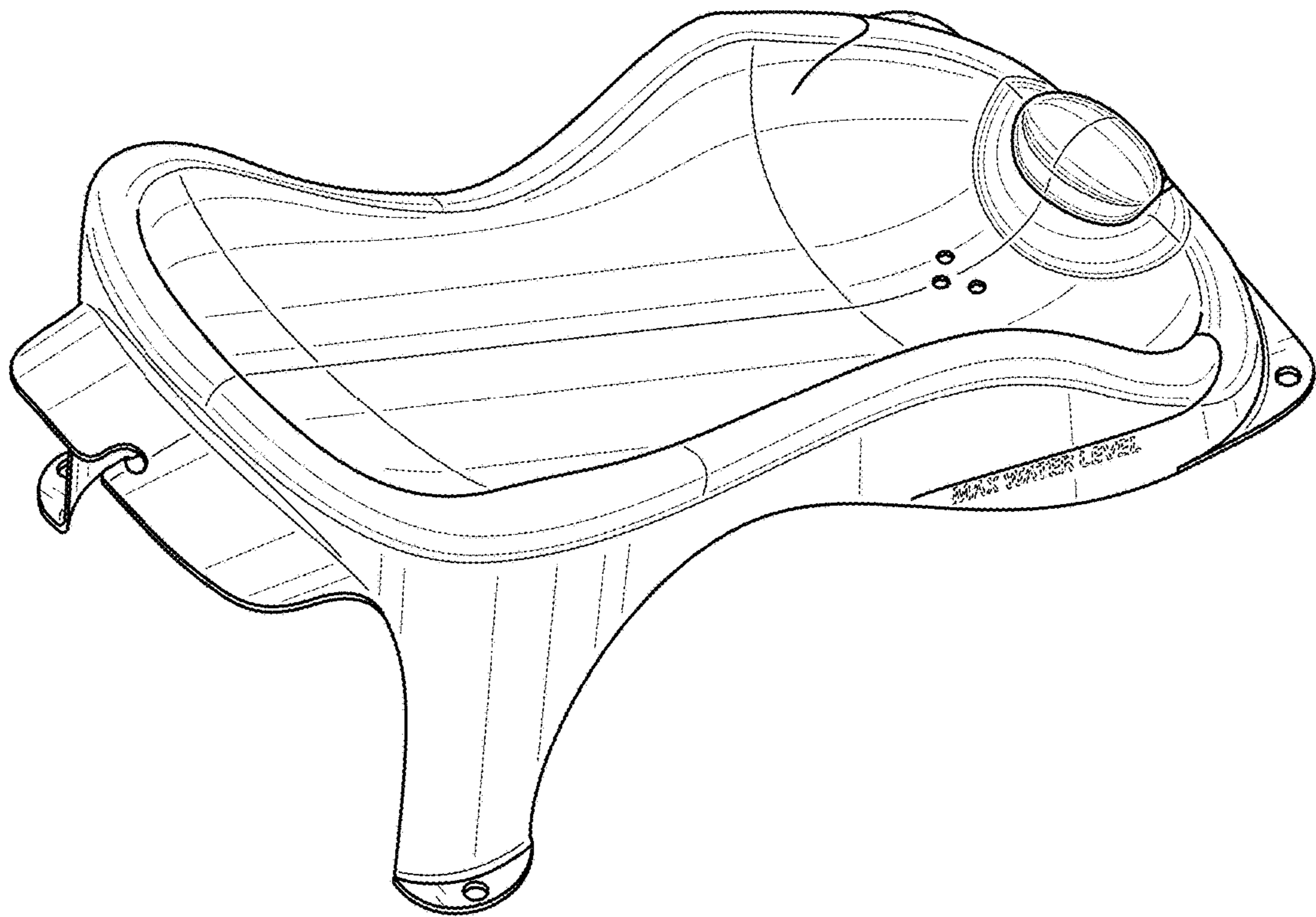

FIG. 5

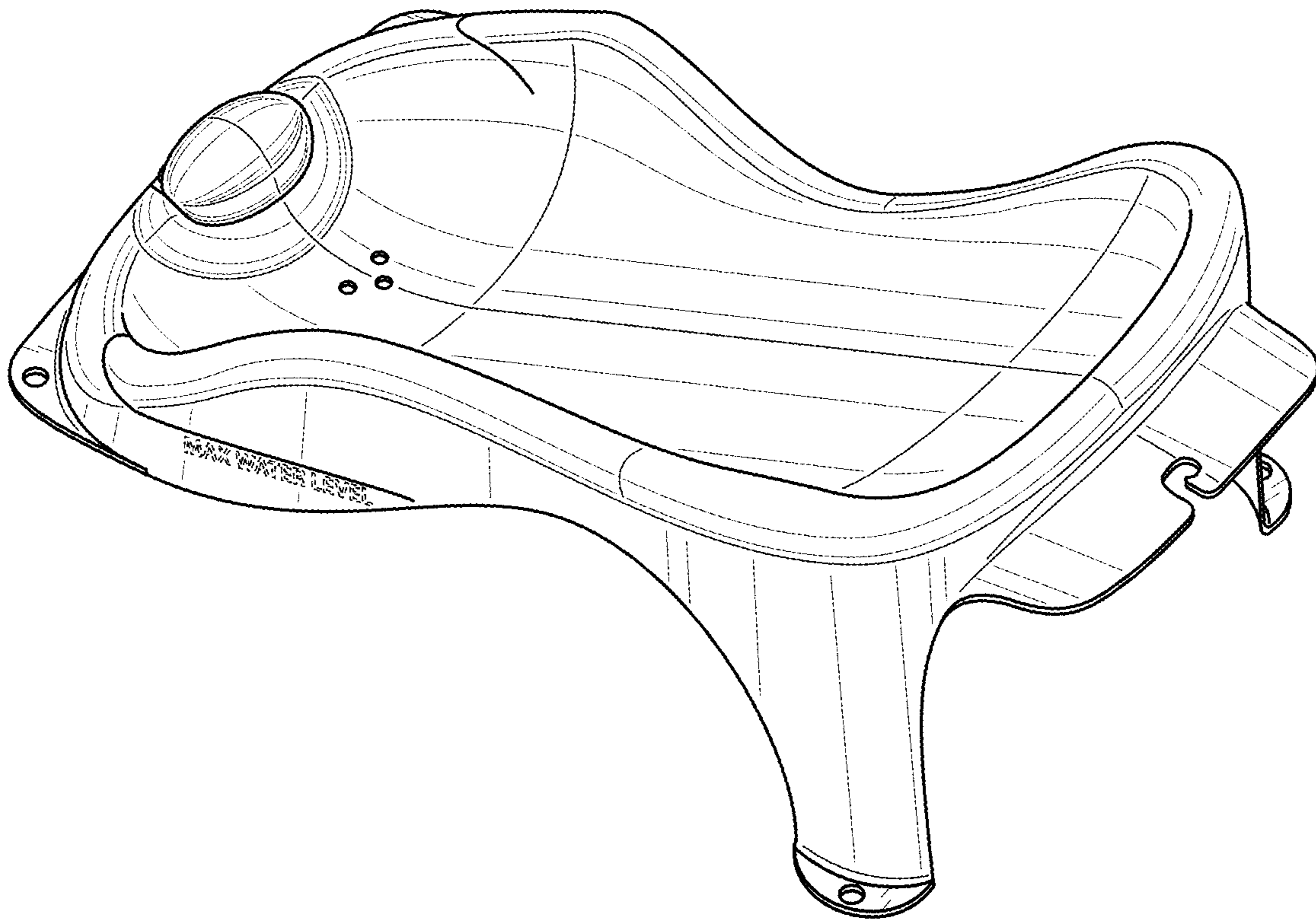

FIG. 6

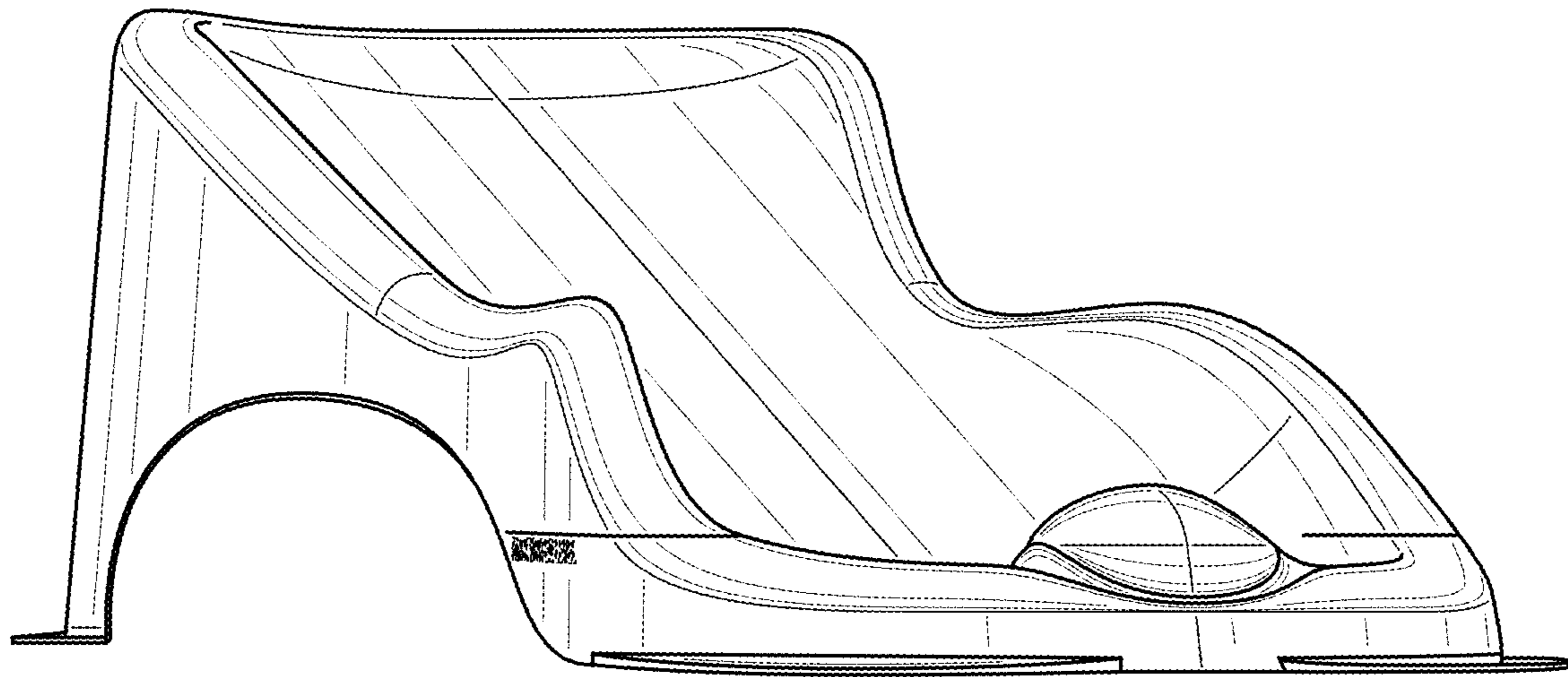

FIG. 7



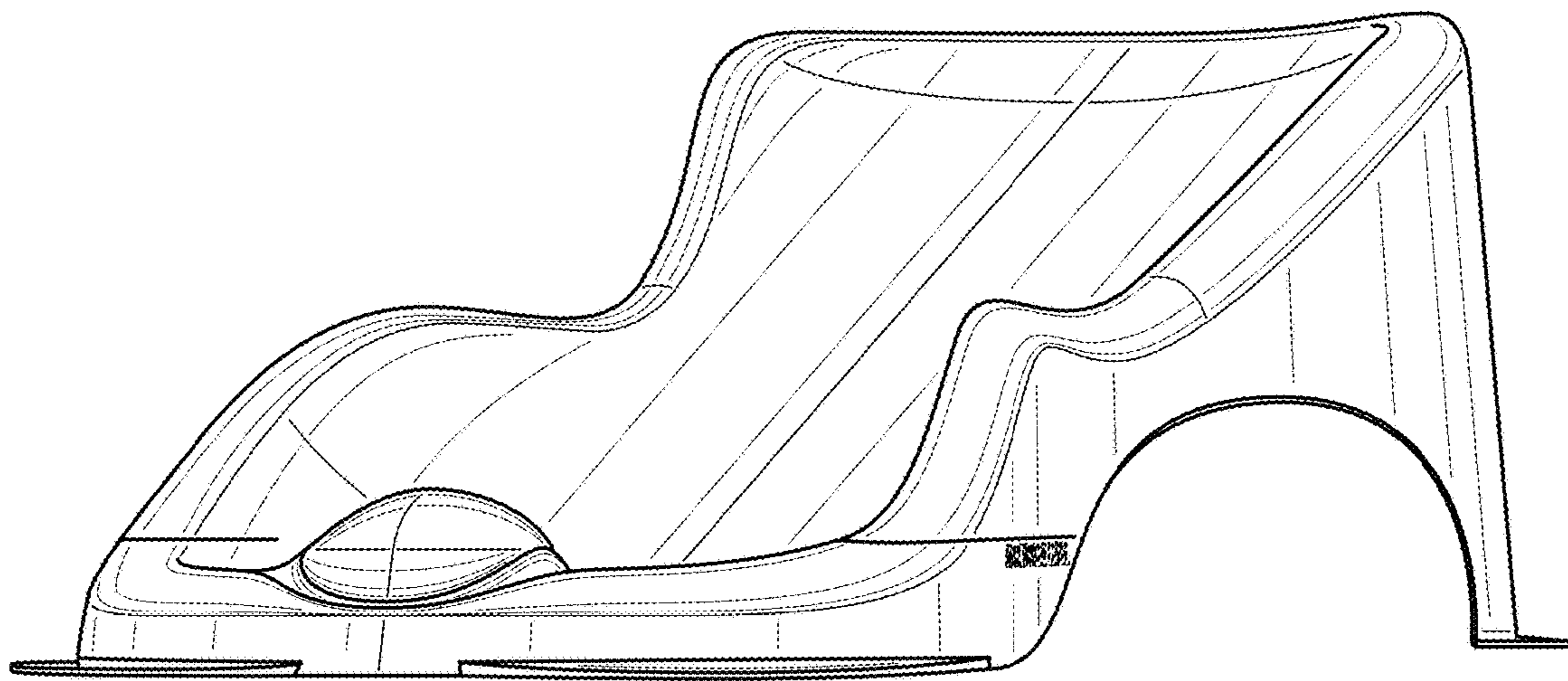

FIG. 8



FIG. 9



FIG. 10

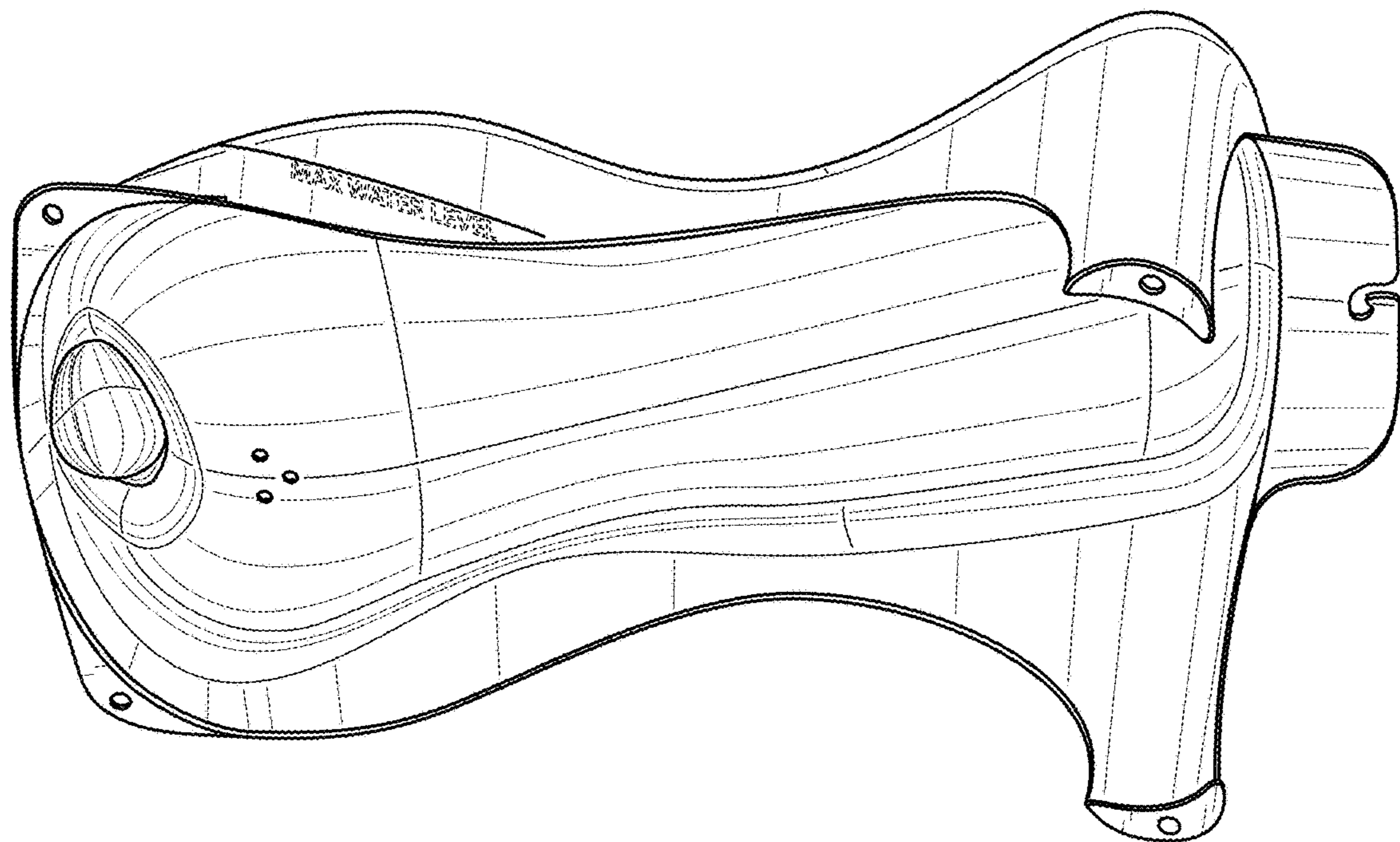

FIG. 11

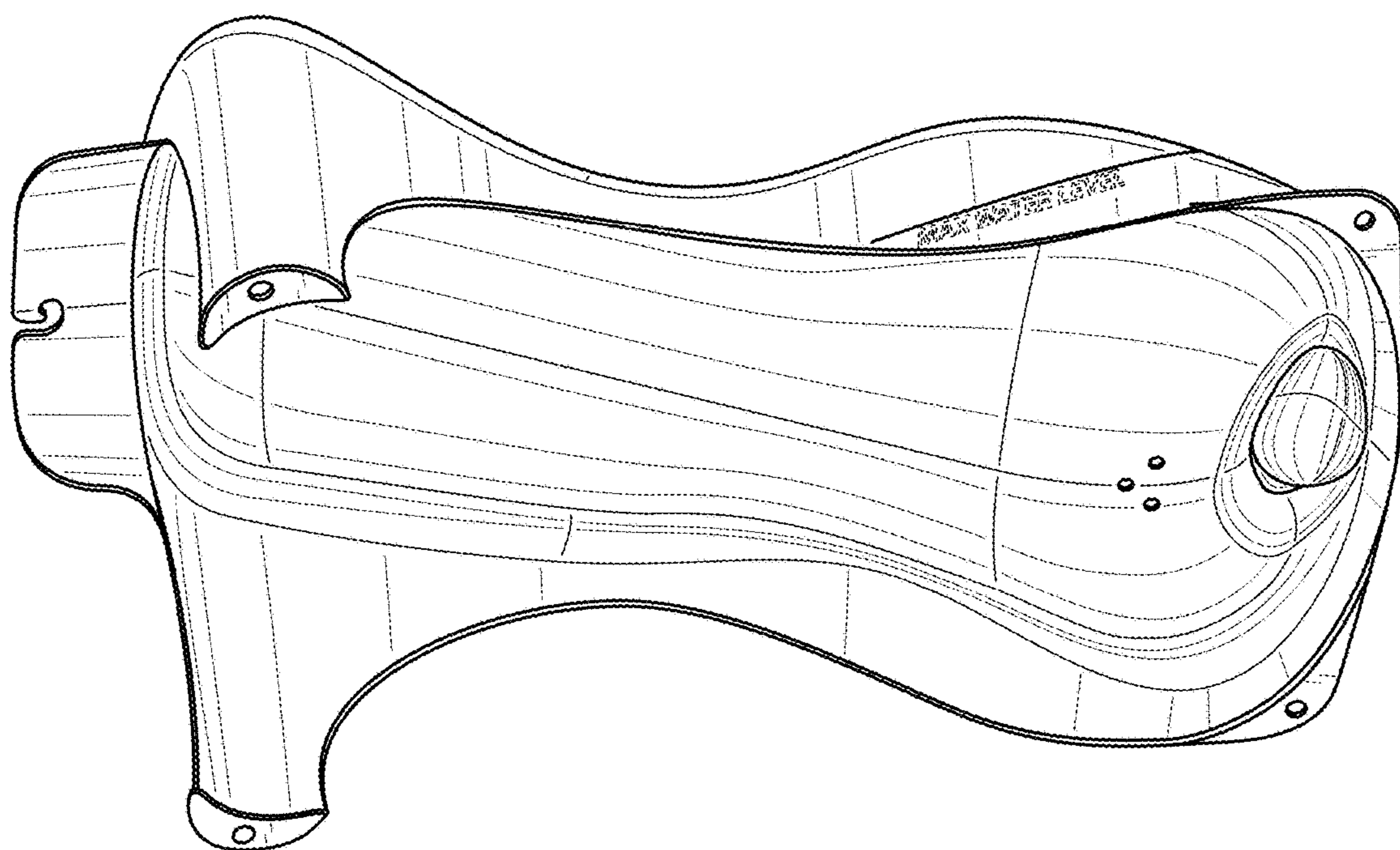

FIG. 12



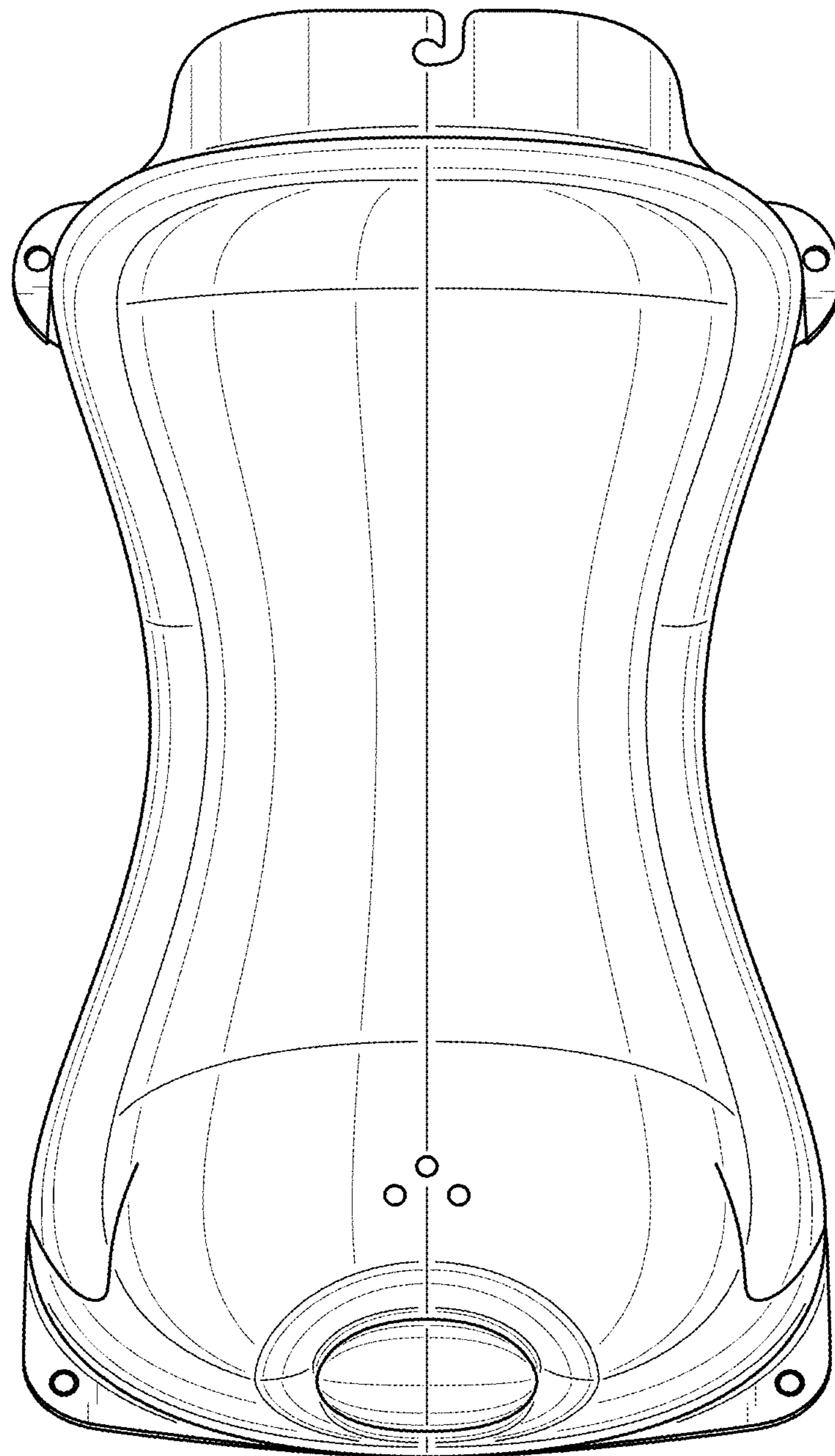

FIG. 13

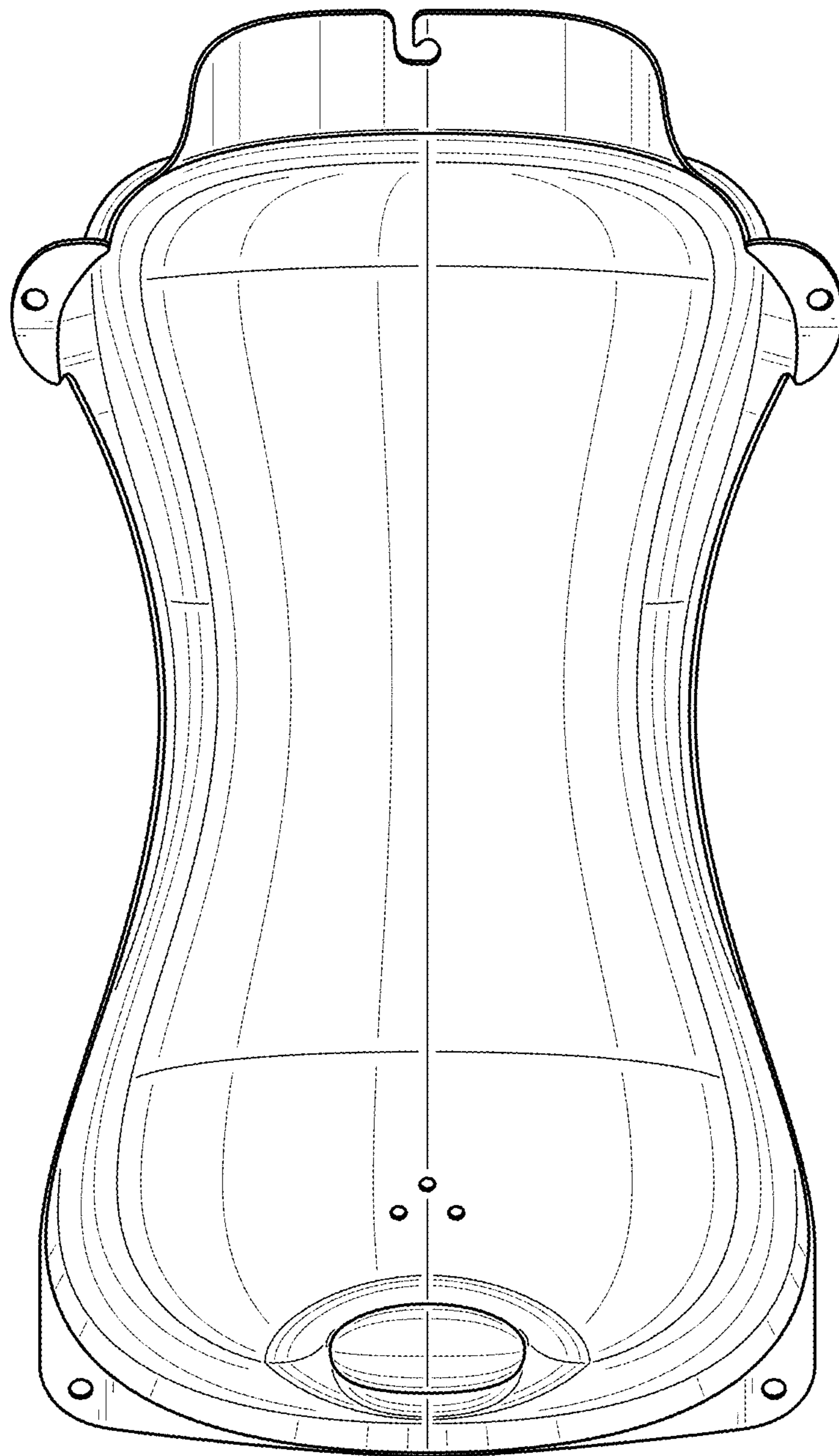

FIG. 14

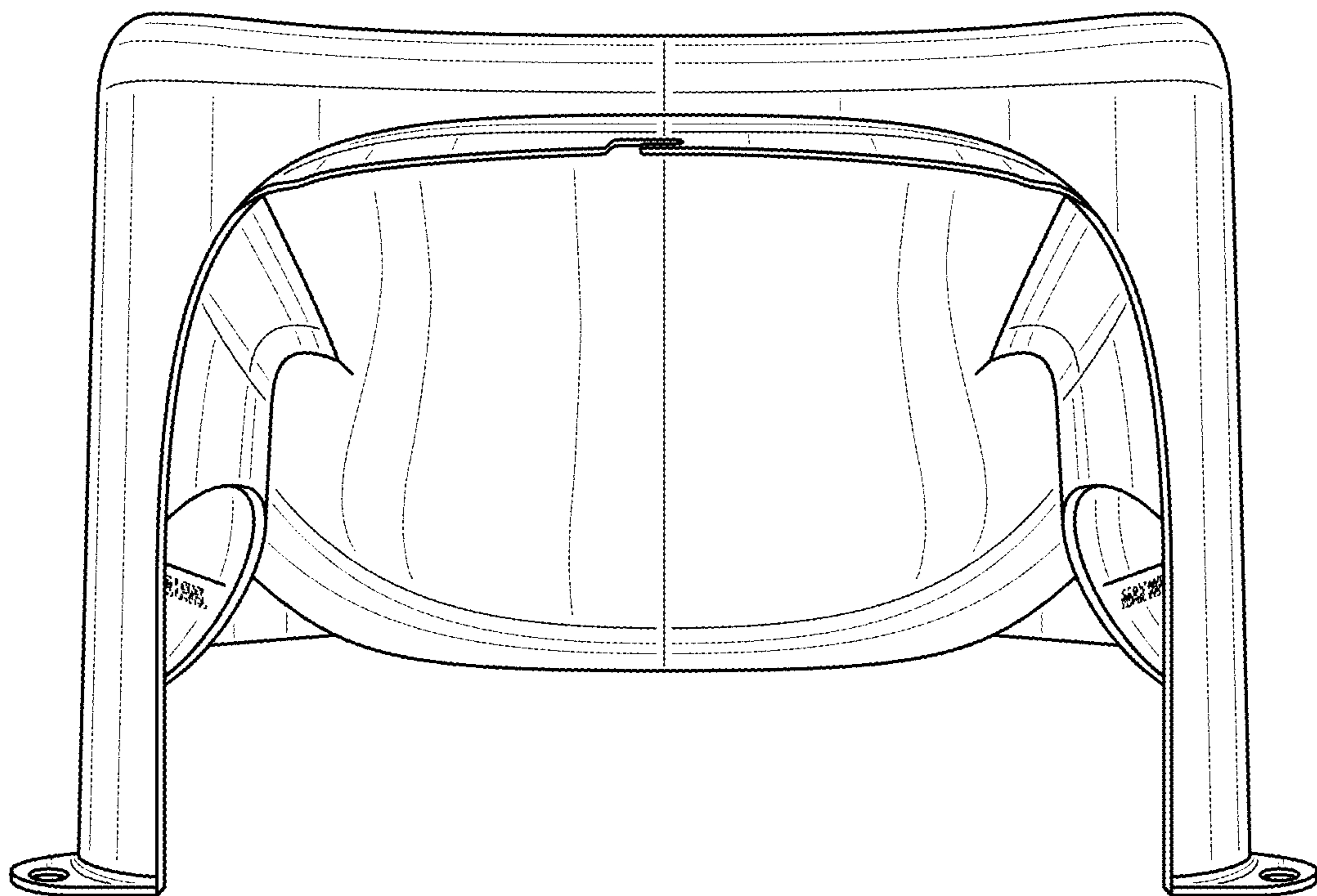

FIG. 15

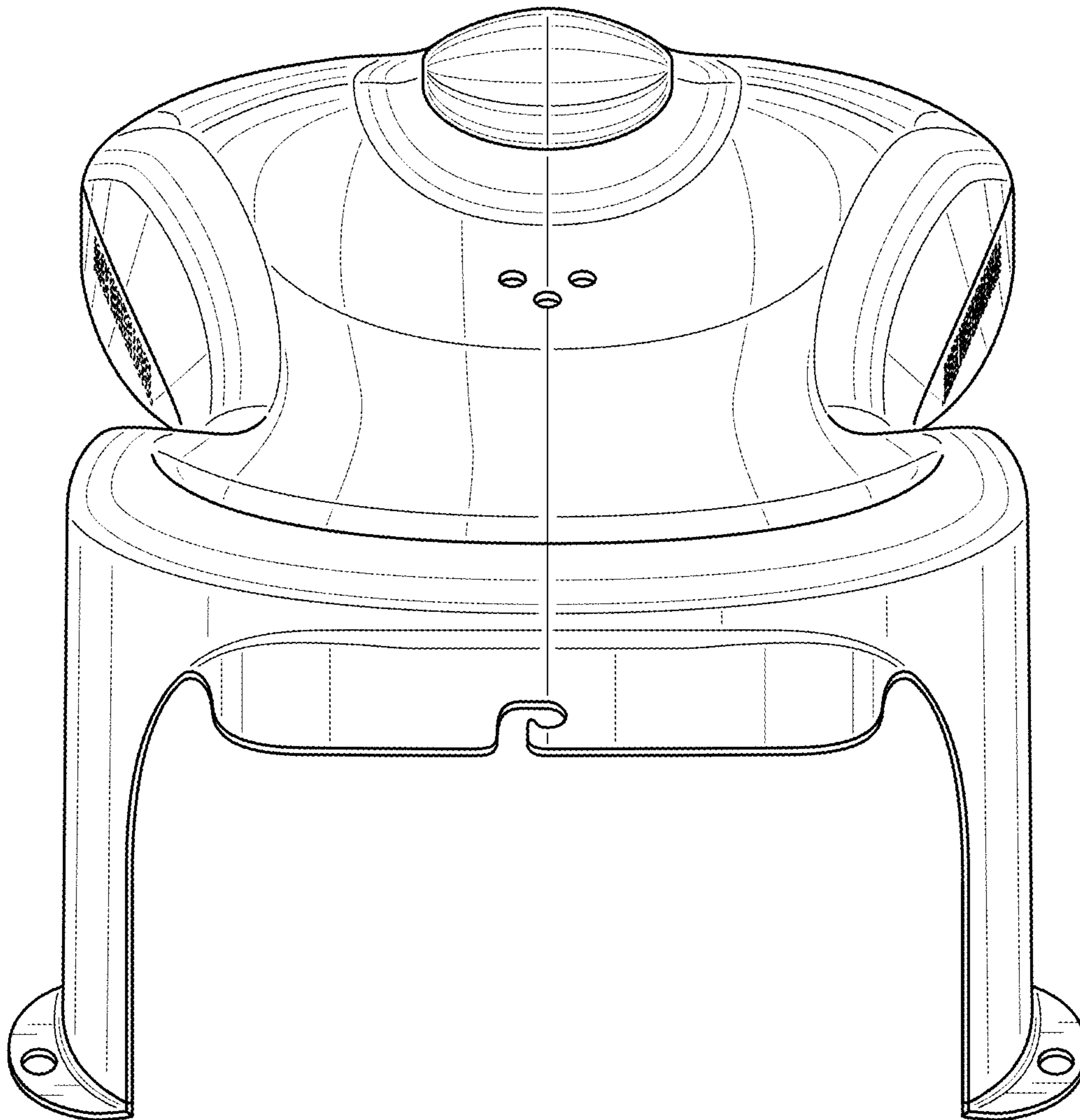

FIG. 16

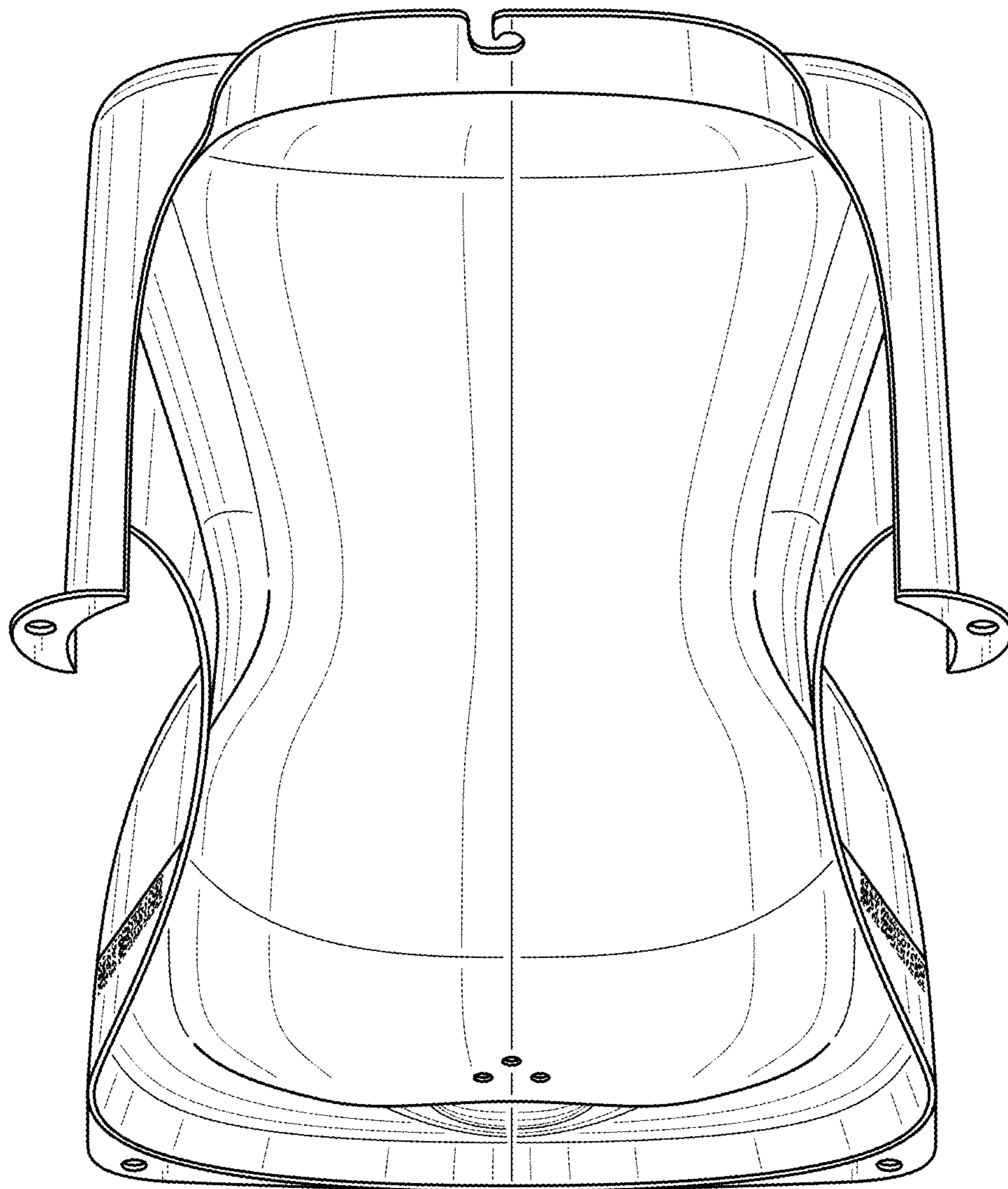

FIG. 17



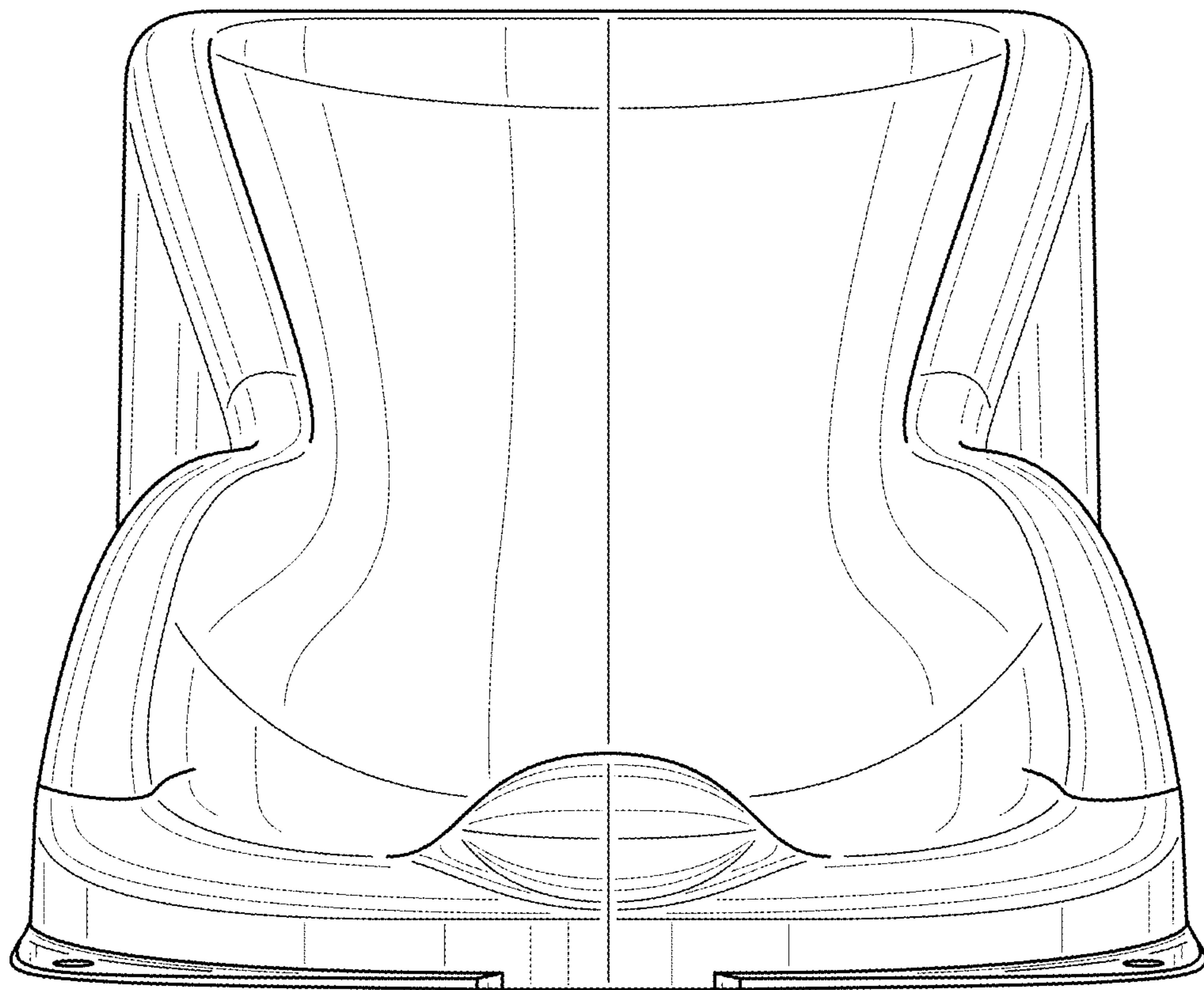

FIG. 18

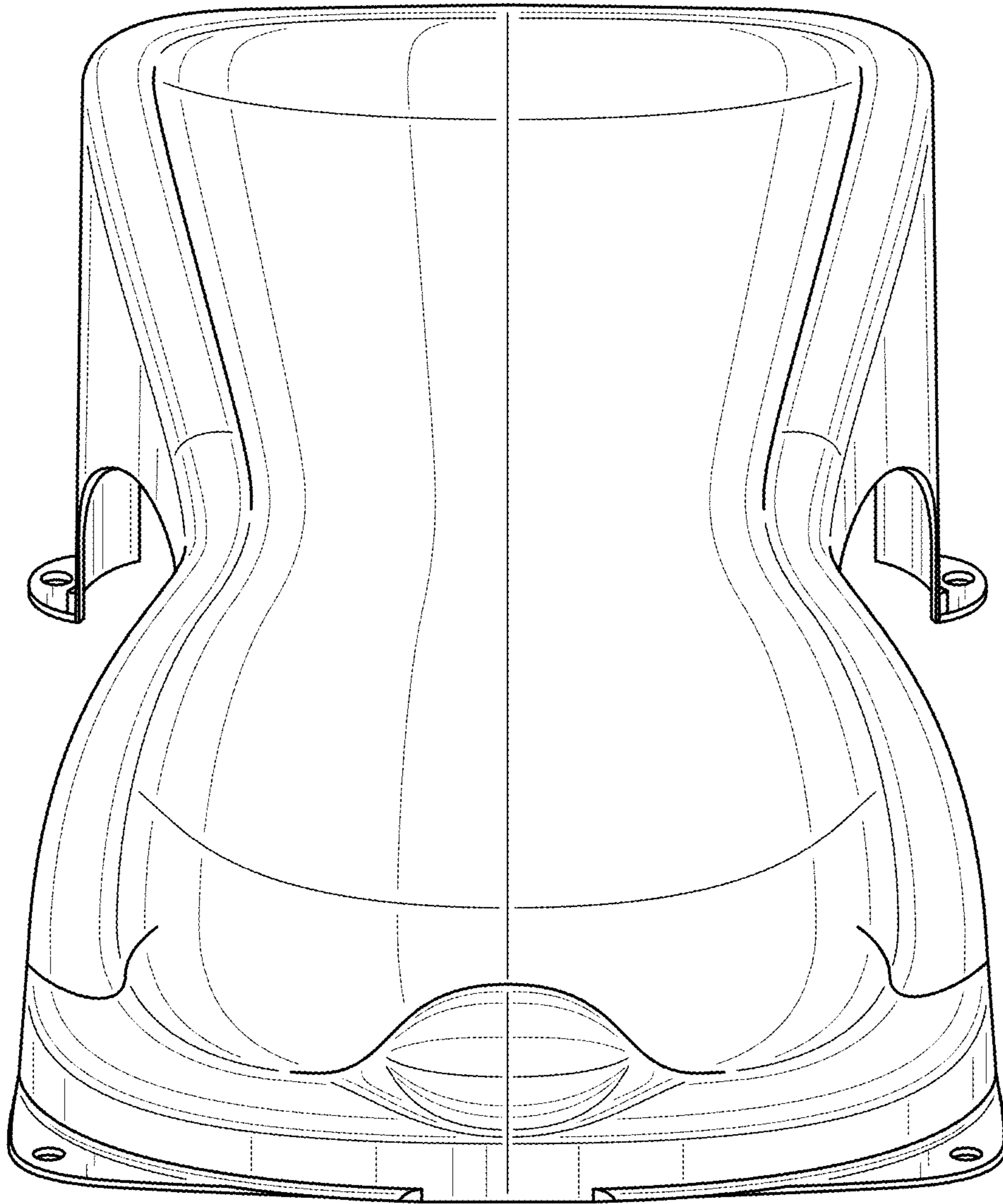

FIG. 19

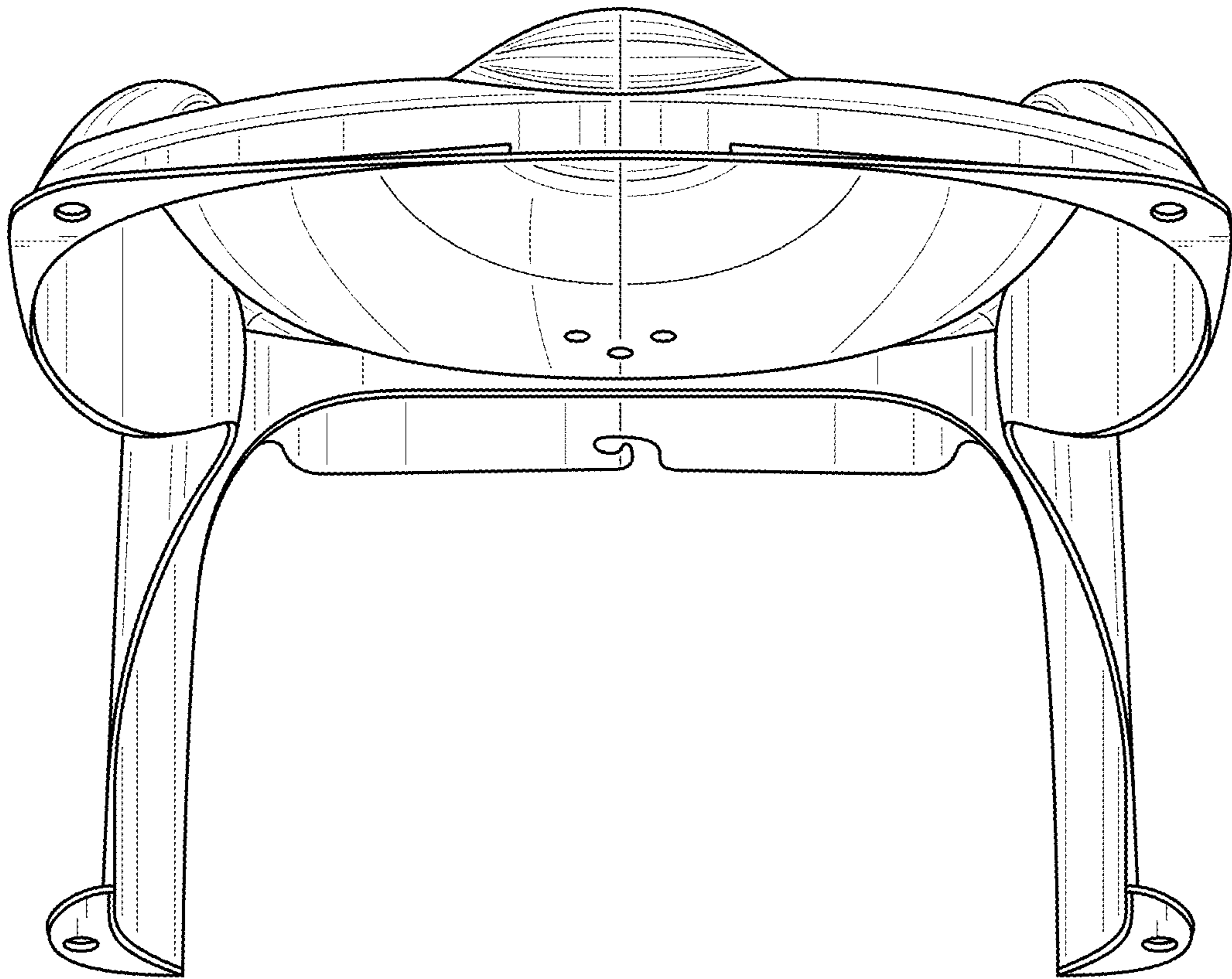

FIG. 20

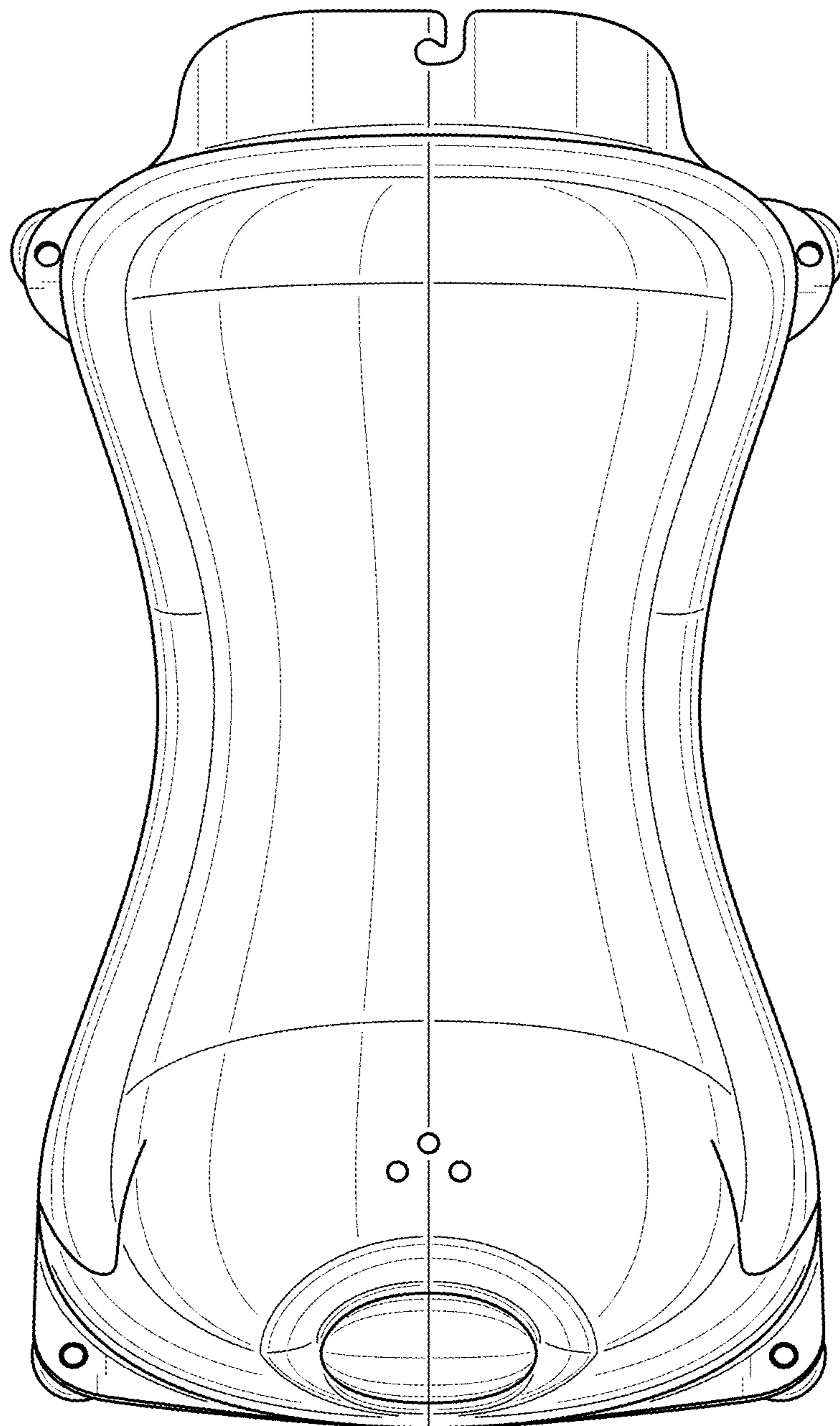

FIG. 21

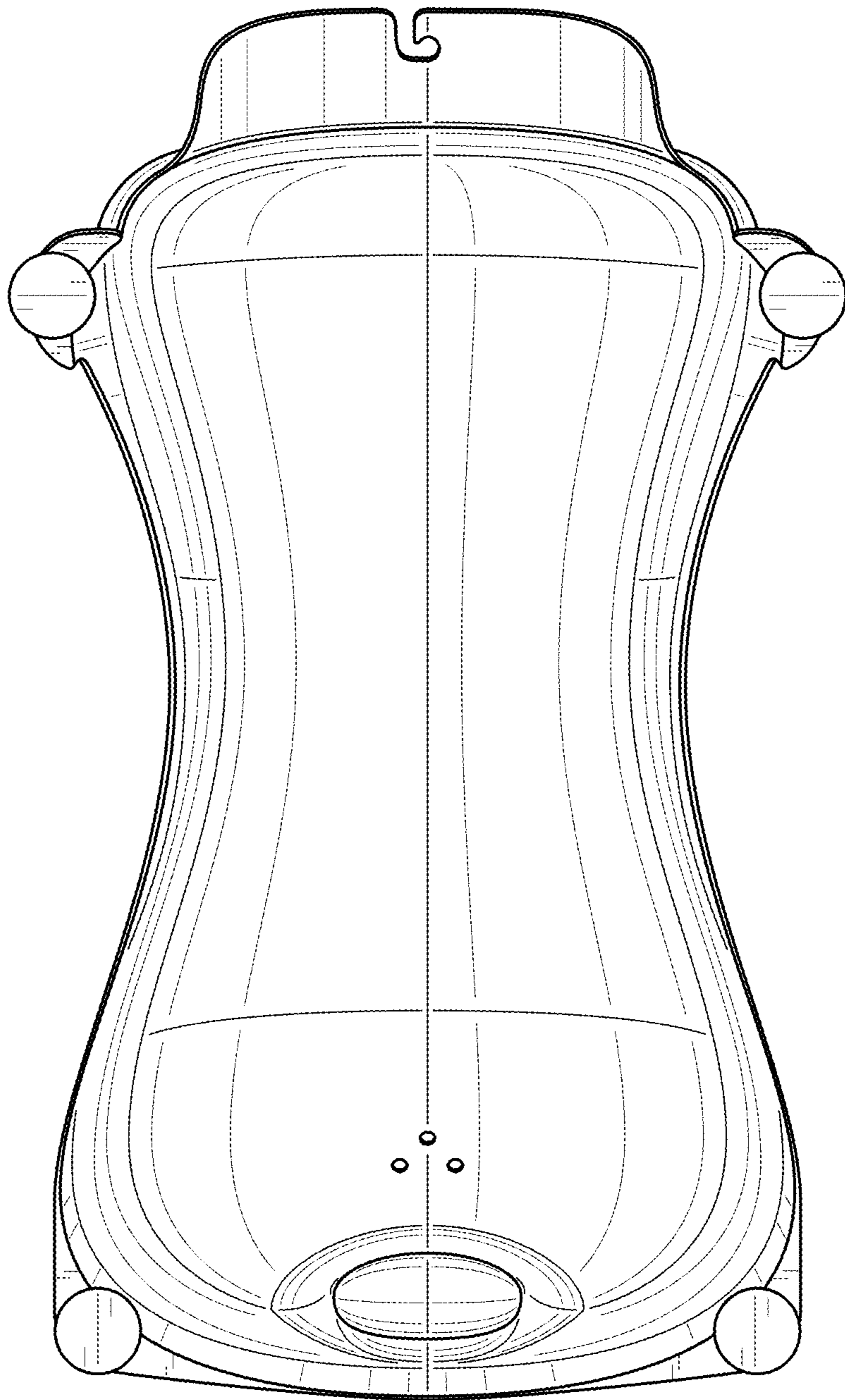

FIG. 22



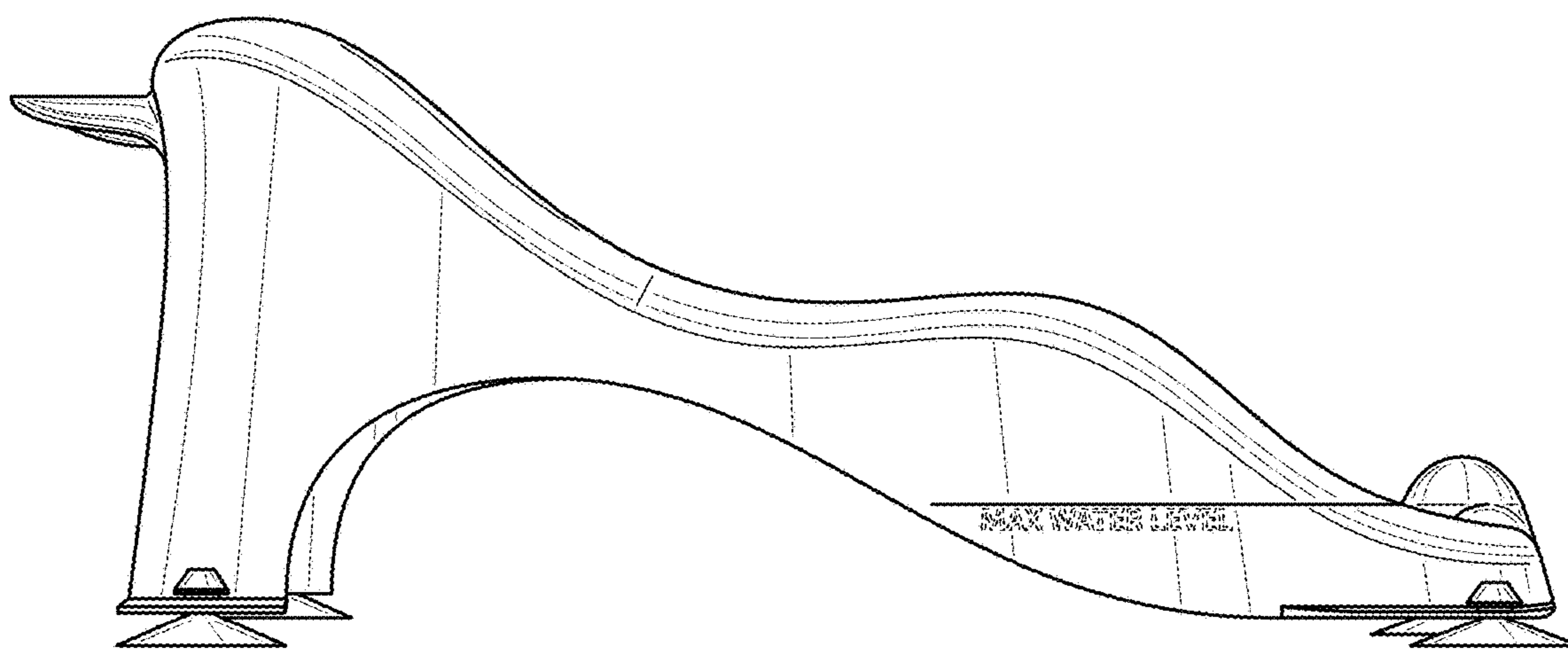

FIG. 23

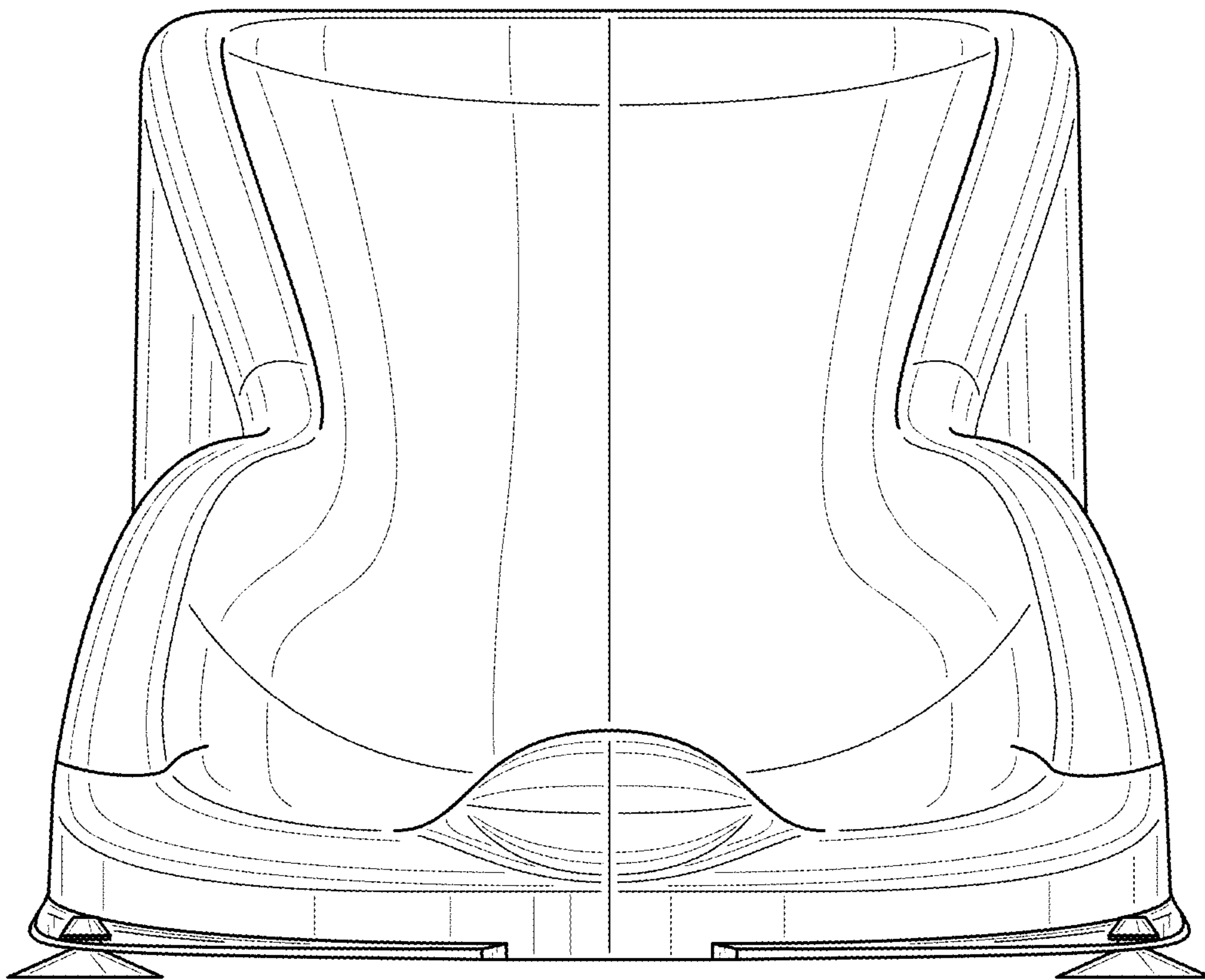

FIG. 24

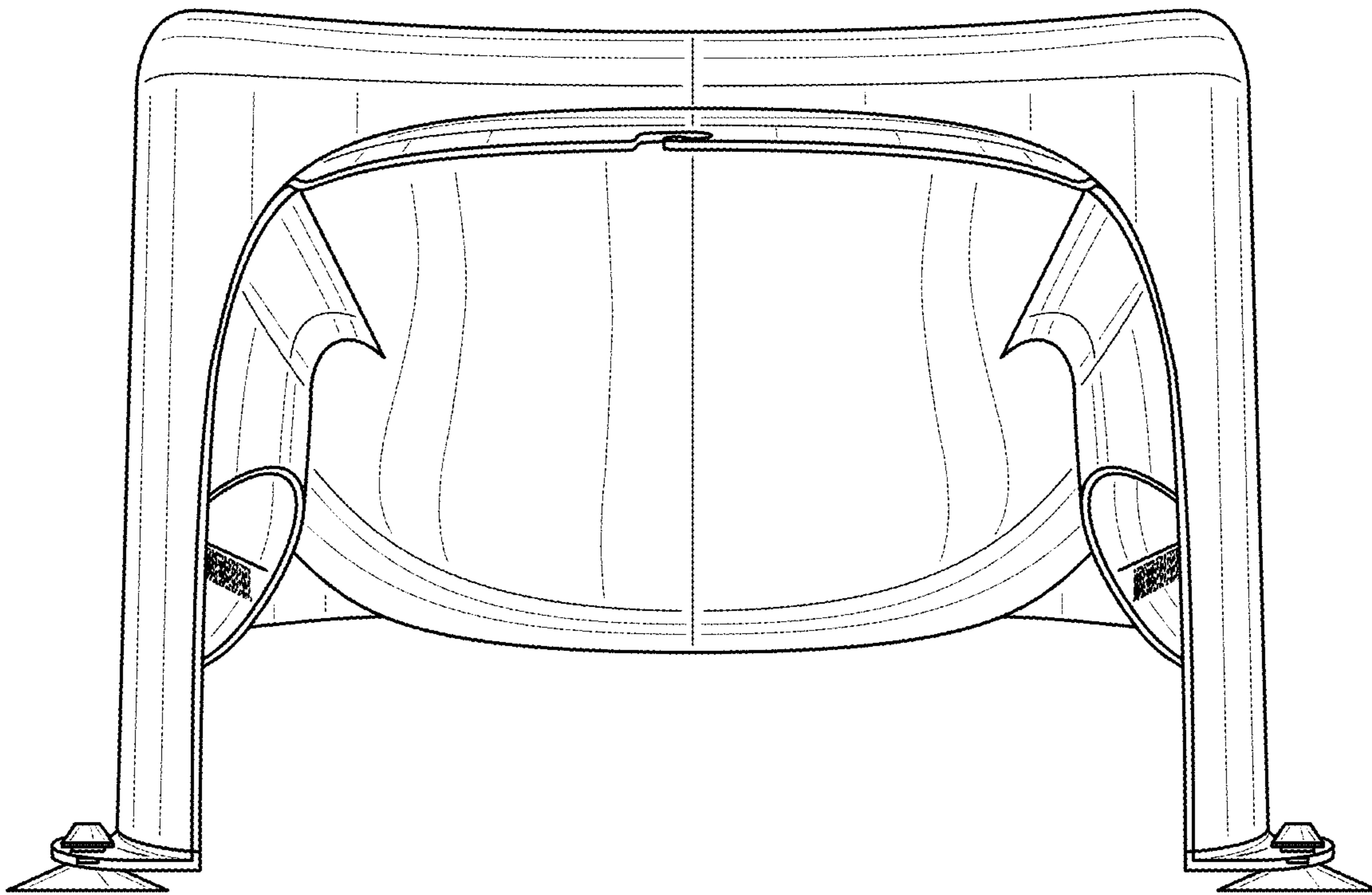

FIG. 25