



US00D795398S

(12) **United States Design Patent**
Decaria et al.

(10) **Patent No.:** **US D795,398 S**
(45) **Date of Patent:** **** Aug. 22, 2017**

(54) **CAP PIPE FITTING**

(57) **CLAIM**

(71) Applicant: **Lubrizol Advanced Materials, Inc.**,
Cleveland, OH (US)

The ornamental design for a cap pipe fitting, as shown and described.

(72) Inventors: **Domenic C. Decaria**, Brecksville, OH (US); **James A. Michalenko**, Avon Lake, OH (US); **Andrew J. Midlik**, Parma, OH (US); **Mark D. Julius**, Avon, OH (US)

DESCRIPTION

(73) Assignee: **Lubrizol Advanced Materials, Inc.**,
Cleveland, OH (US)

(**) Term: **14 Years**

FIG. 1 is a top left perspective view of a first embodiment of a cap pipe fitting having a hexagonal outer shell. FIG. 2 is a bottom right perspective view of FIG. 1; FIG. 3 is a top plan view of FIG. 1; FIG. 4 is a bottom plan view of FIG. 1; FIG. 5 is a left view of FIG. 1; FIG. 6 is a right view of FIG. 1; FIG. 7 is a front plan view of FIG. 1; and FIG. 8 is a rear plan view of FIG. 1. FIG. 9 is a top left perspective view of a second embodiment of a can pipe fitting having an octagonal outer shell. FIG. 10 is a bottom right perspective view of FIG. 9; FIG. 11 is a top plan view of FIG. 9; FIG. 12 is a bottom plan view of FIG. 9; FIG. 13 is a left view of FIG. 9; FIG. 14 is a right view of FIG. 9; FIG. 15 is a front plan view of FIG. 9; and FIG. 16 is a rear plan view of FIG. 9. FIG. 17 is a top left perspective view of a third embodiment of a cap pipe fitting having a decagonal outer shell; FIG. 18 is a bottom right perspective view of FIG. 17; FIG. 19 is a top plan view of FIG. 17; FIG. 20 is a bottom plan view of FIG. 17; FIG. 21 is a left view of FIG. 17; FIG. 22 is a right view of FIG. 17; FIG. 23 is a front plan view of FIG. 17; and FIG. 24 is a rear plan view of FIG. 17. FIG. 25 is a top left perspective view of a fourth embodiment of a cap pipe fitting having a dodecagonal outer shell; FIG. 26 is a bottom right perspective view of FIG. 25; FIG. 27 is a top plan view of FIG. 25; FIG. 28 is a bottom plan view of FIG. 25; FIG. 29 is a left view of FIG. 25; FIG. 30 is a right view of FIG. 25; FIG. 31 is a front plan view of FIG. 25; and, FIG. 32 is a rear plan view of FIG. 25.

(21) Appl. No.: **29/517,511**

(22) Filed: **Feb. 13, 2015**

(51) **LOC (10) Cl.** **23-01**

(52) **U.S. Cl.**
USPC **D23/260**

(58) **Field of Classification Search**
USPC D23/233–237, 249, 259–269, 393, 499;
D24/129; D13/149; D8/356, 382–383,
(Continued)

(56) **References Cited**

U.S. PATENT DOCUMENTS

D132,938 S 6/1942 Corley
D132,939 S 6/1942 Corley
(Continued)

FOREIGN PATENT DOCUMENTS

CN ZL201030189447.0 11/2010
MX 9159 12/1997
(Continued)

Primary Examiner — Eric Goodman
Assistant Examiner — Amy Wierenga

(74) *Attorney, Agent, or Firm* — Christopher P. Demas;
Teresan W. Gilbert

(Continued)

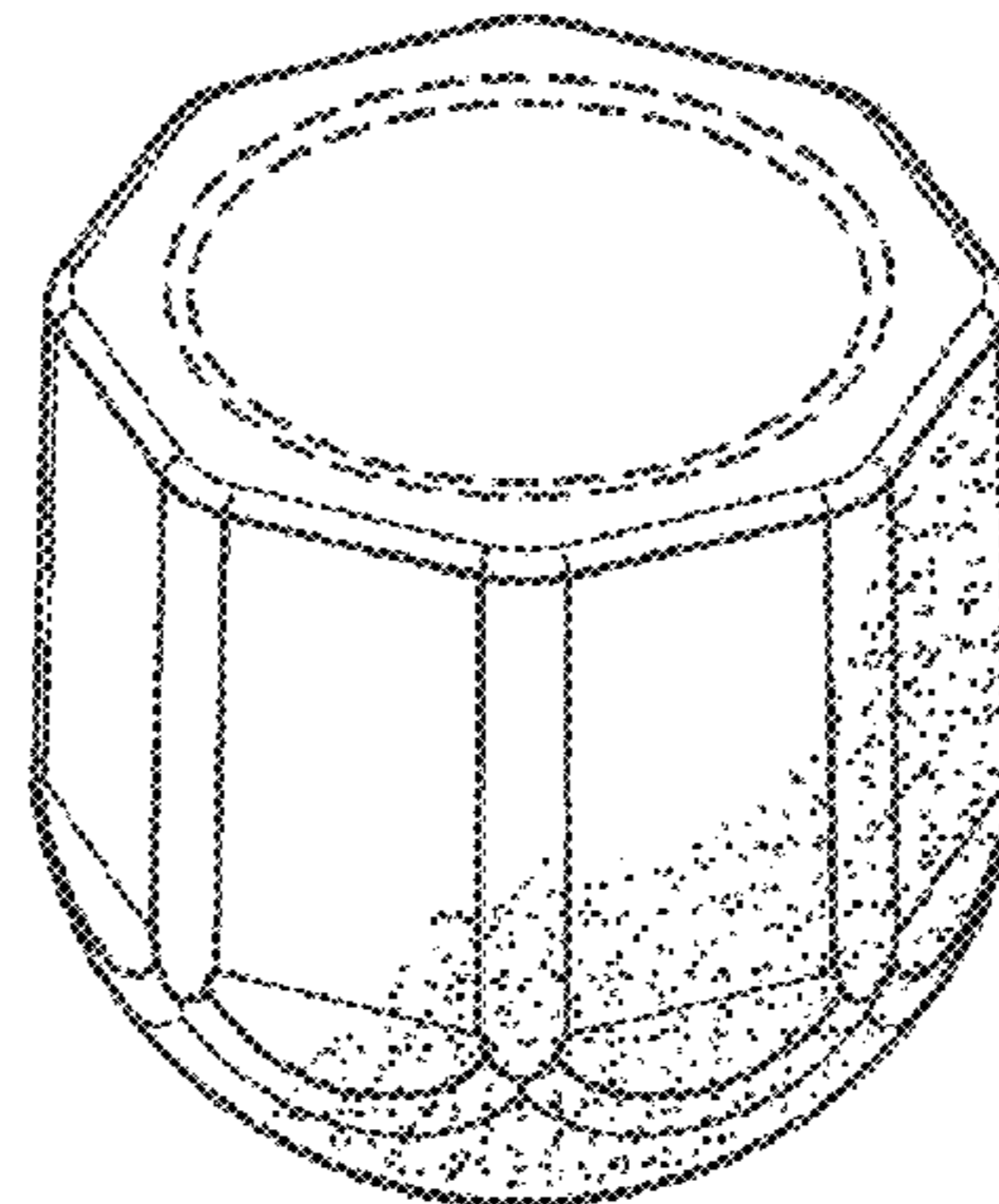
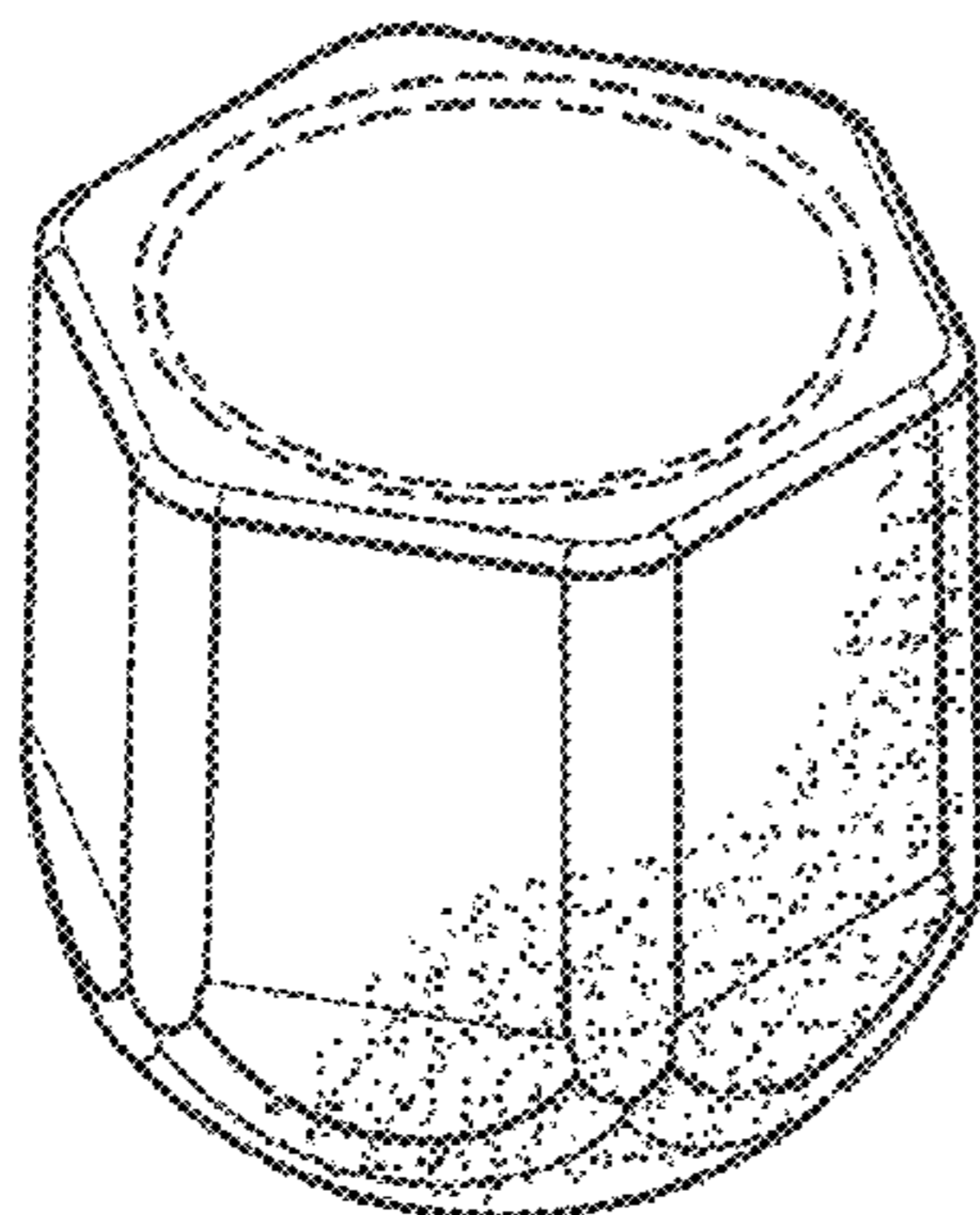

The broken lines in the drawings represent portions of the cap pipe fitting that form no part of the claim.

1 Claim, 8 Drawing Sheets

(58) Field of Classification Search

USPC D8/394, 396–397, 399; D32/25;
 D12/607; D9/435, 454, 516
 CPC F16L 43/001; F16L 19/04; F16L 19/005;
 F16L 19/0218; F16L 55/1152; F16L
 27/04; F16L 27/073; F16L 25/14; E21B
 17/042; B29C 70/345; B29C 70/462;
 H01R 4/58; F16N 21/06; F16B 39/24;
 F16B 39/26; F16B 37/02; F16B 31/02;
 D06F 58/10; A62C 3/00; H01M 6/26

See application file for complete search history.

(56) References Cited

U.S. PATENT DOCUMENTS

D137,384 S 2/1944 Corley
 2,416,829 A * 3/1947 Hartley F16L 55/1152
 138/89
 D170,408 S * 9/1953 Gries D8/397
 D179,768 S 2/1957 Giles
 2,867,143 A * 1/1959 Appleton H01R 4/58
 29/751
 3,441,292 A 4/1969 Gross
 3,844,586 A 10/1974 Olen
 D254,802 S * 4/1980 Hayes D23/262
 D434,834 S 12/2000 Goto
 D445,736 S * 7/2001 Sheu D12/607
 D462,112 S 8/2002 Koza

D533,259 S 12/2006 Lewis
 D549,804 S 8/2007 Lewis
 D552,221 S 10/2007 Beutler
 D554,237 S 10/2007 Lewis
 D564,642 S 3/2008 Pipe
 D606,853 S * 12/2009 Shapiro D8/397
 D617,428 S 6/2010 Bachmann
 D634,816 S 3/2011 Qian
 D634,820 S 3/2011 Leroyer
 D648,005 S 11/2011 Morishita
 D648,006 S 11/2011 Morishita
 D662,409 S * 6/2012 Woolstencroft D8/399
 D675,289 S 1/2013 Freudendahl
 D675,290 S 1/2013 Mitchell
 D675,291 S 1/2013 Mitchell
 D675,292 S 1/2013 Mitchell
 D675,293 S 1/2013 Mitchell
 D675,294 S 1/2013 Mitchell
 D676,941 S 2/2013 Kluss
 D704,543 S * 5/2014 Kuhmichel D8/397
 D706,126 S * 6/2014 Orow D8/397
 D712,821 S * 9/2014 Puppis D12/607
 D729,907 S * 5/2015 Castrigno D23/260
 2002/0106263 A1 * 8/2002 Winker B21K 1/70
 411/533
 2003/0049526 A1 * 3/2003 Kao H01M 6/26
 429/176
 2012/0074687 A1 3/2012 Mitchell

FOREIGN PATENT DOCUMENTS

MX 22550 4/2007
 MX 23308 8/2007
 MX 23309 8/2007
 MX 34093 8/2011
 MX 37761 2/2012
 WO DM/052171 8/2000

* cited by examiner

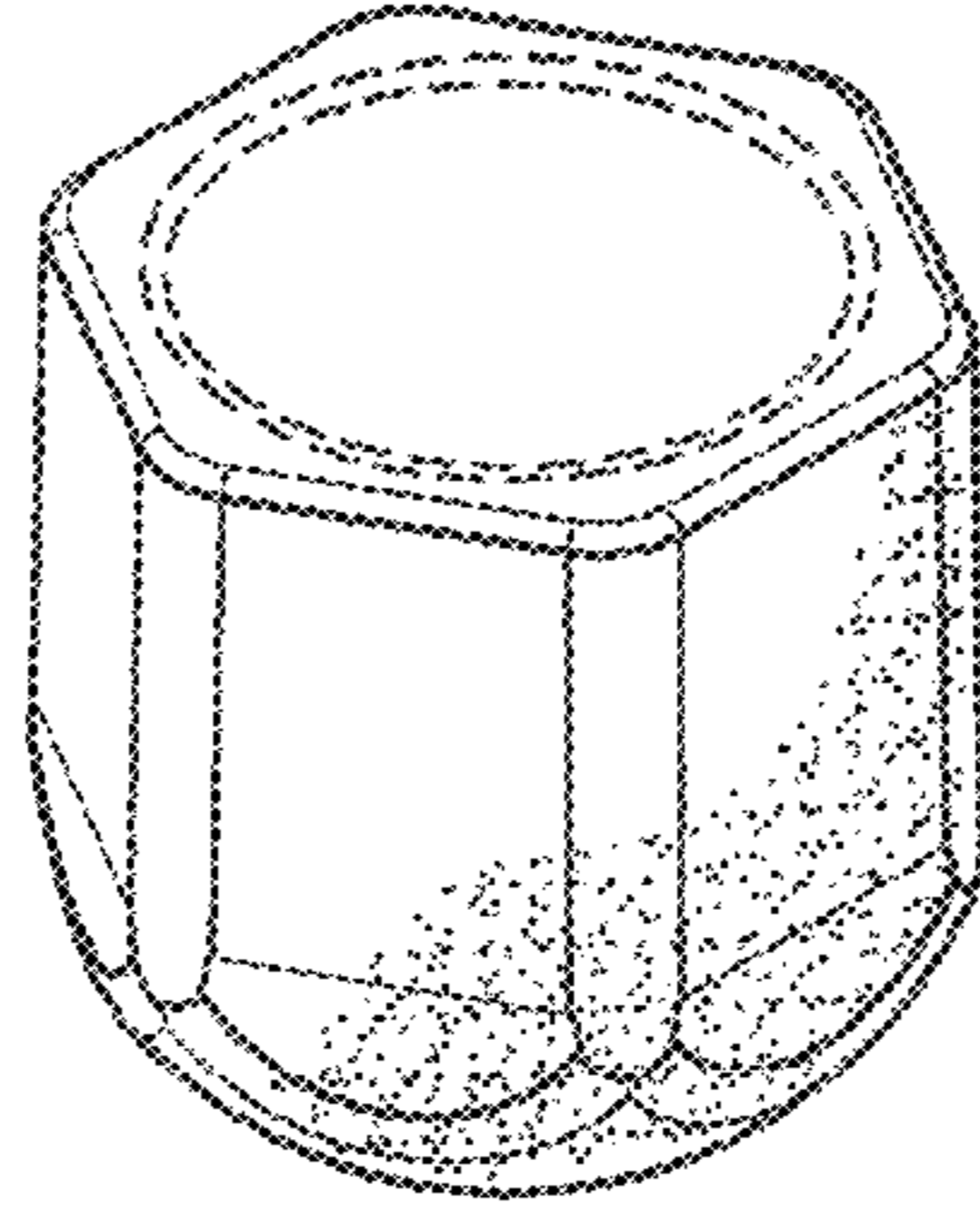

FIG. 1

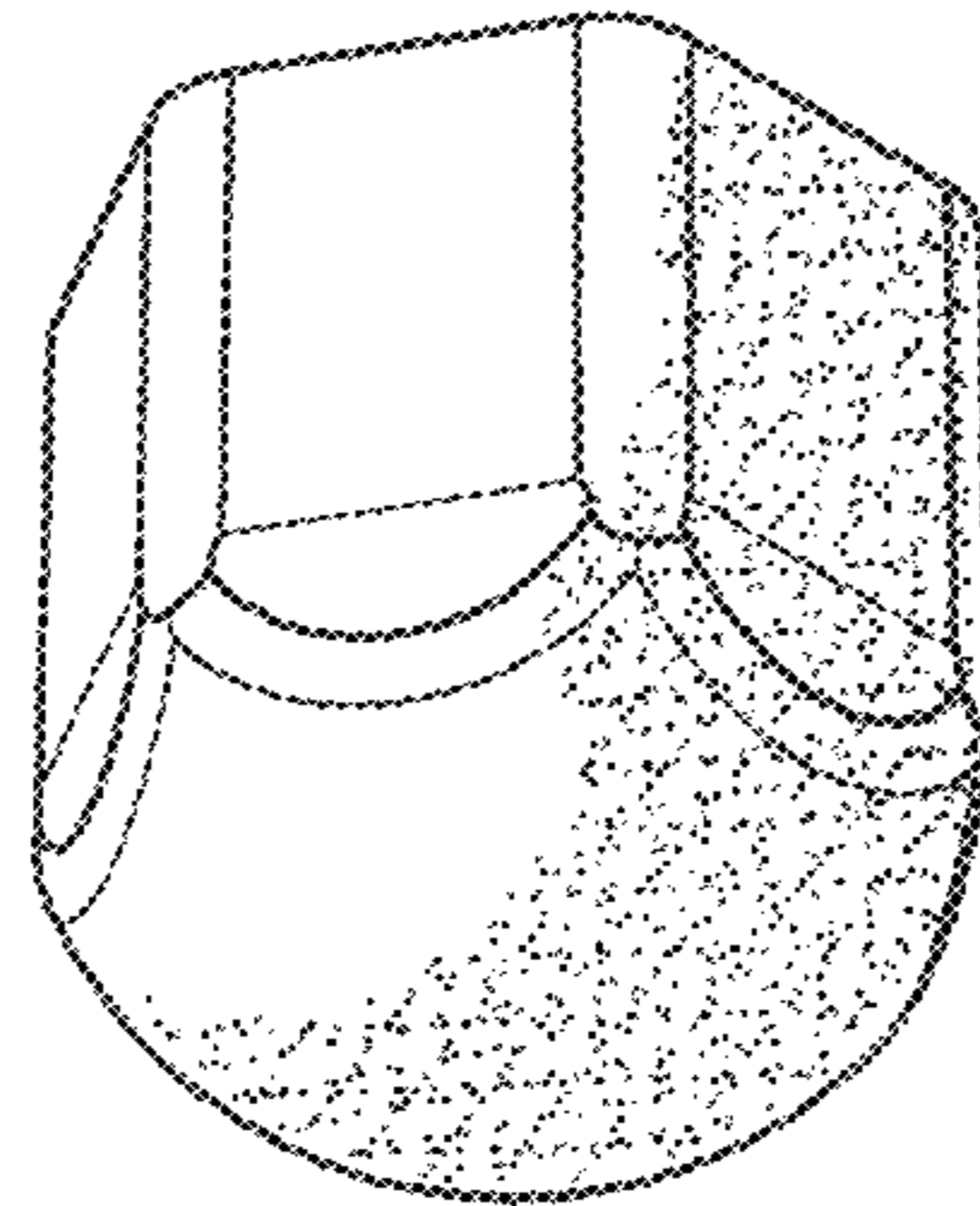

FIG. 2

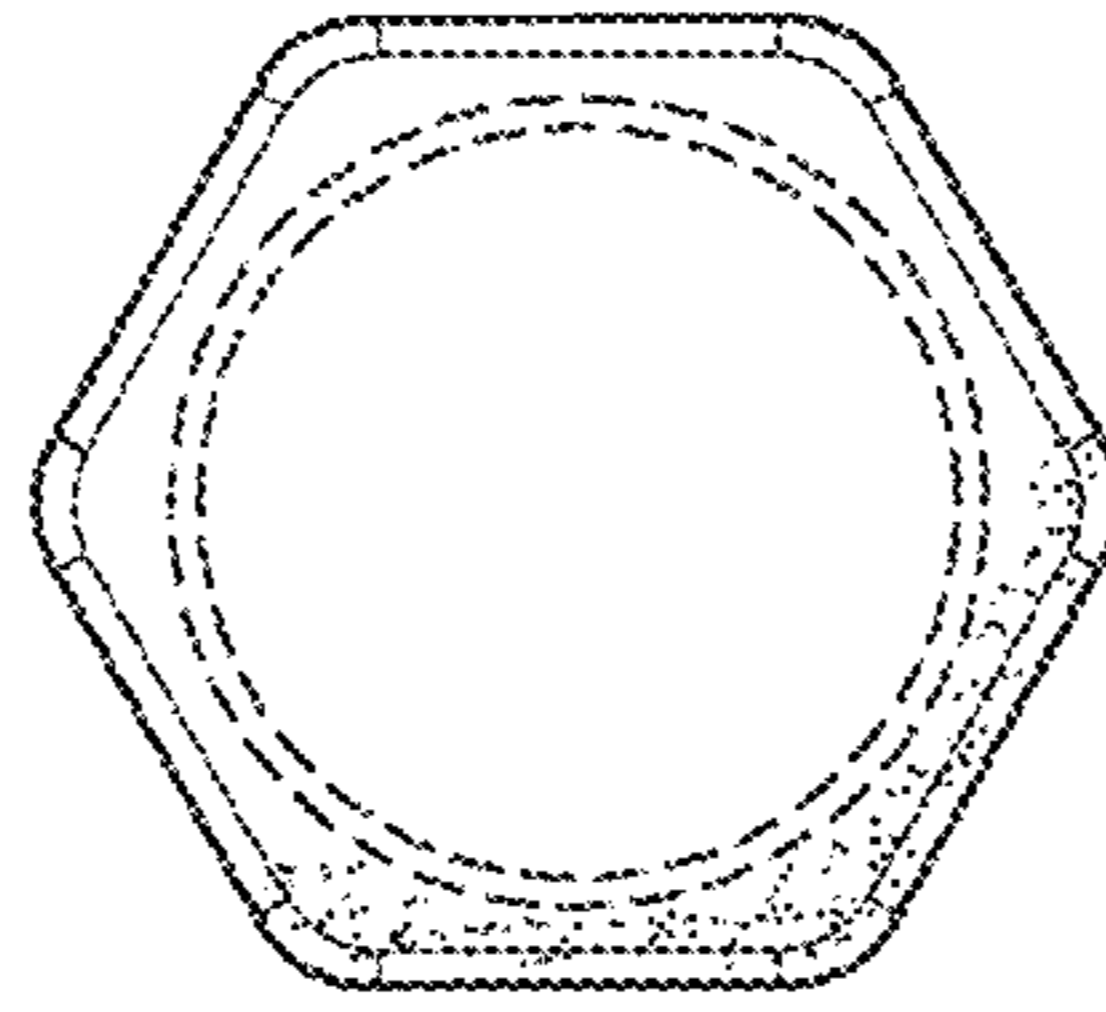

FIG. 3

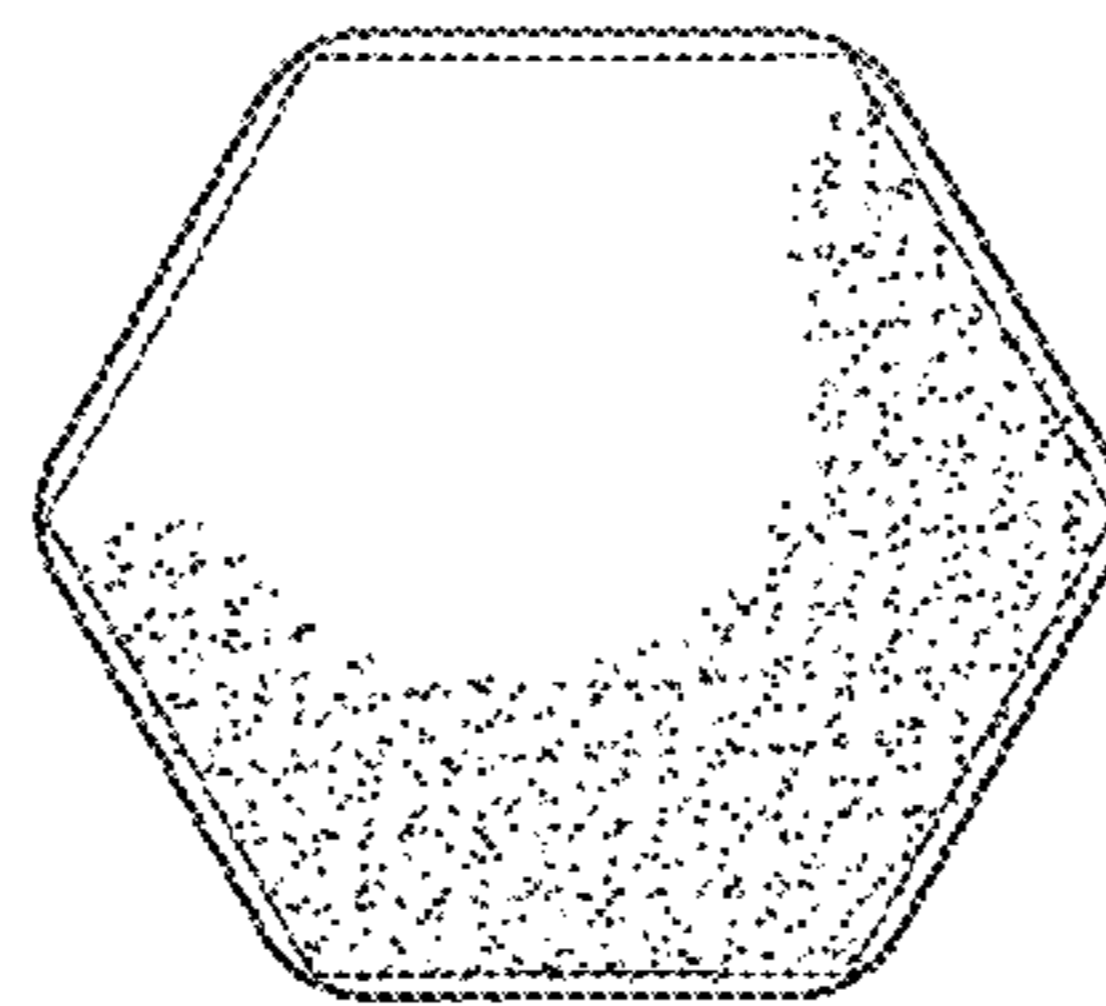

FIG. 4

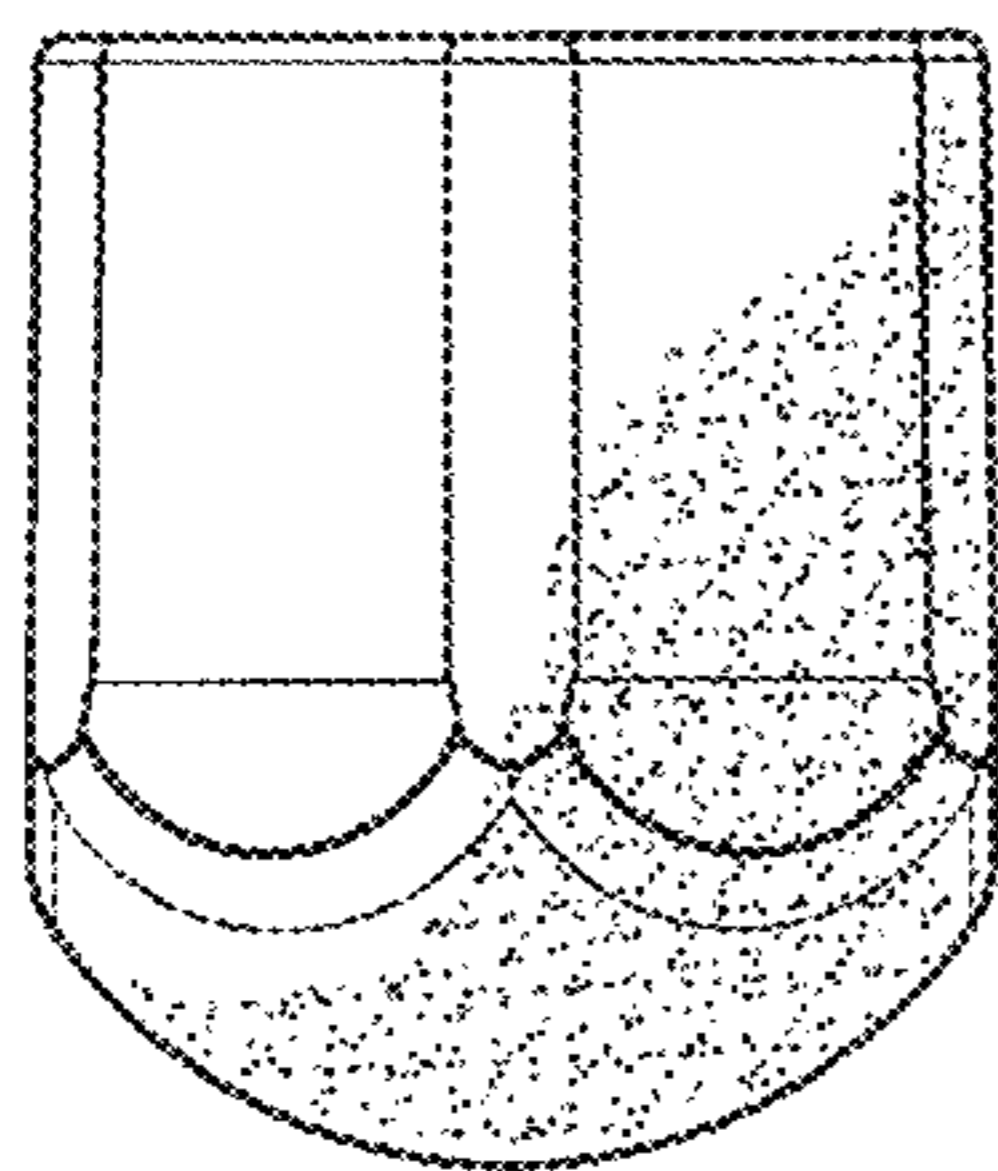

FIG. 5

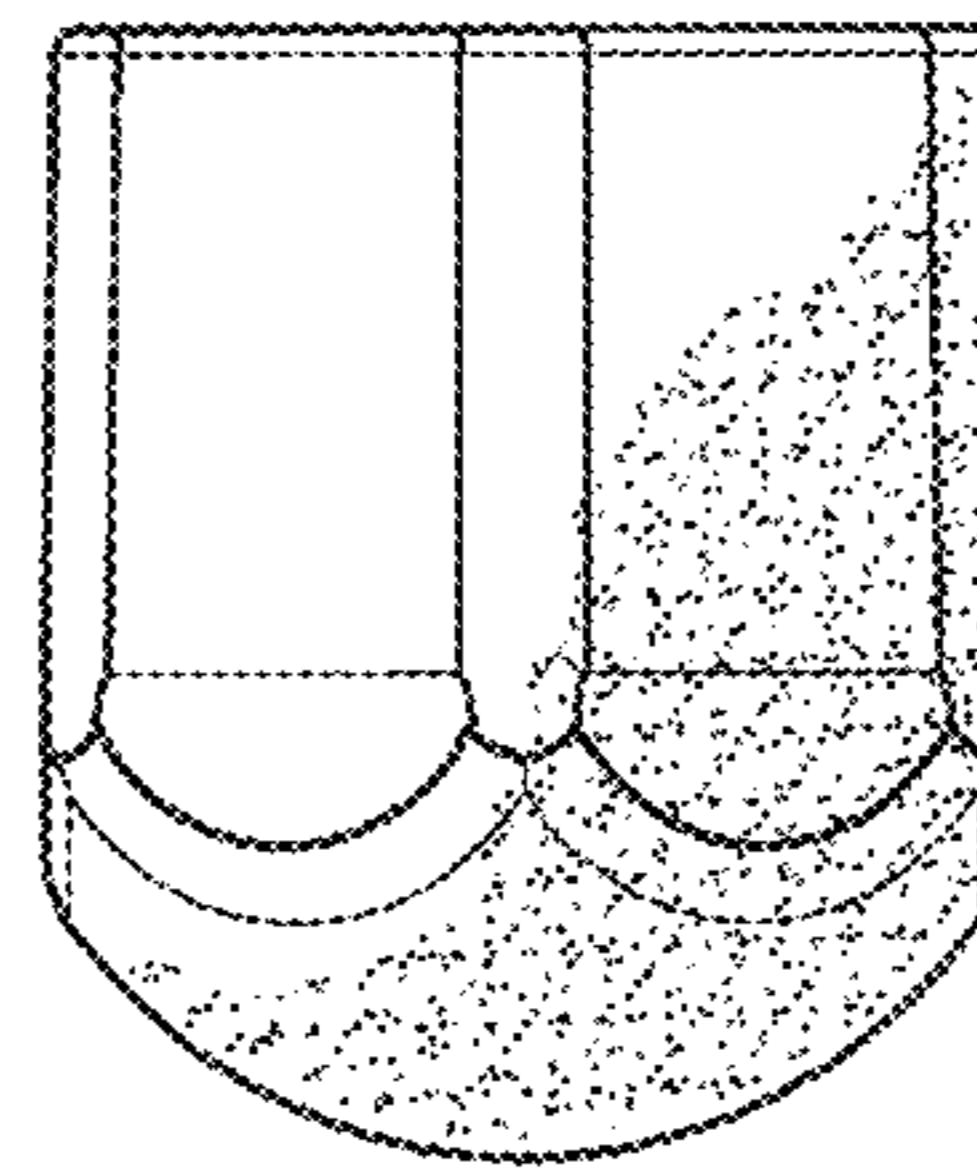

FIG. 6

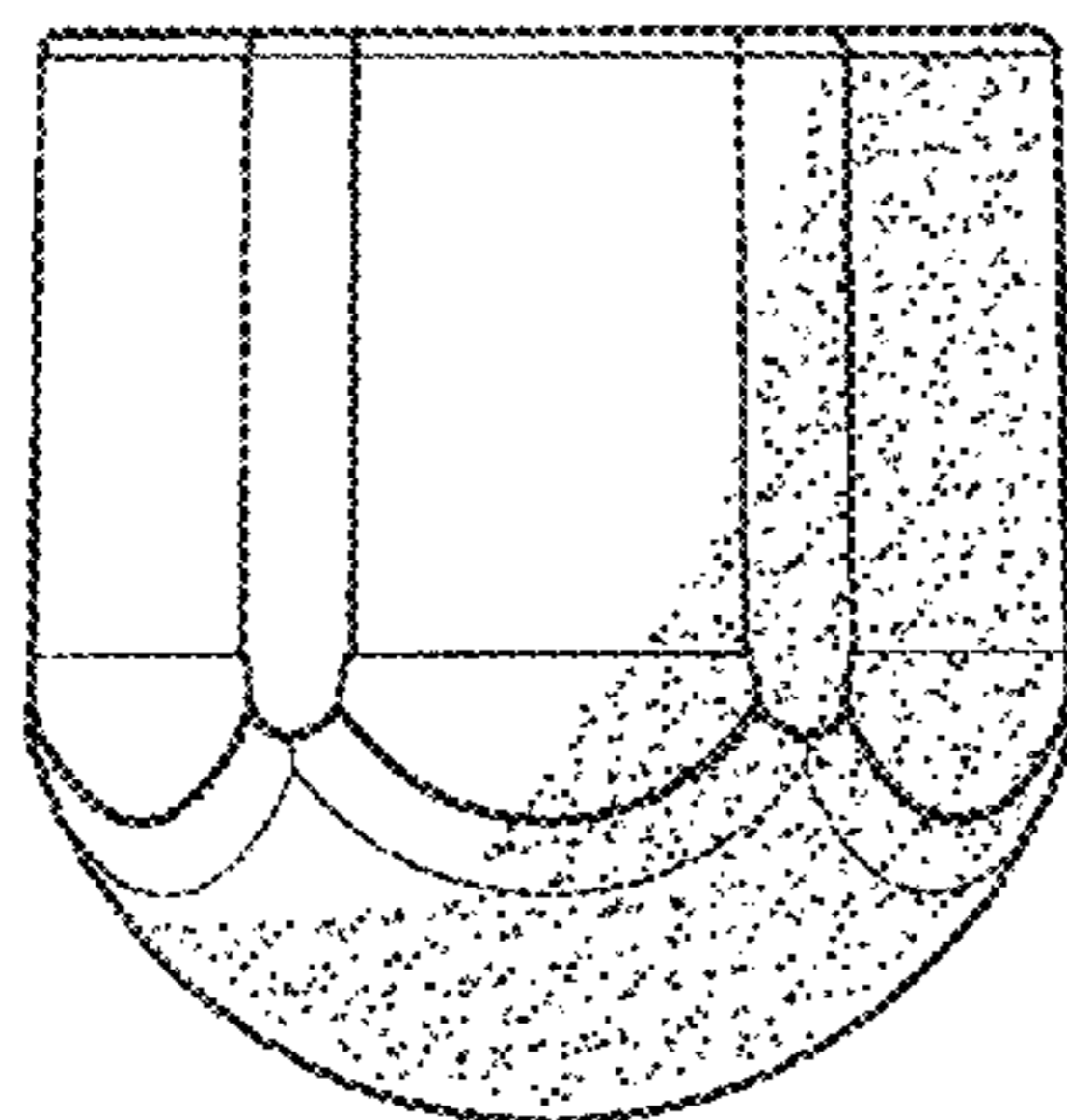

FIG. 7

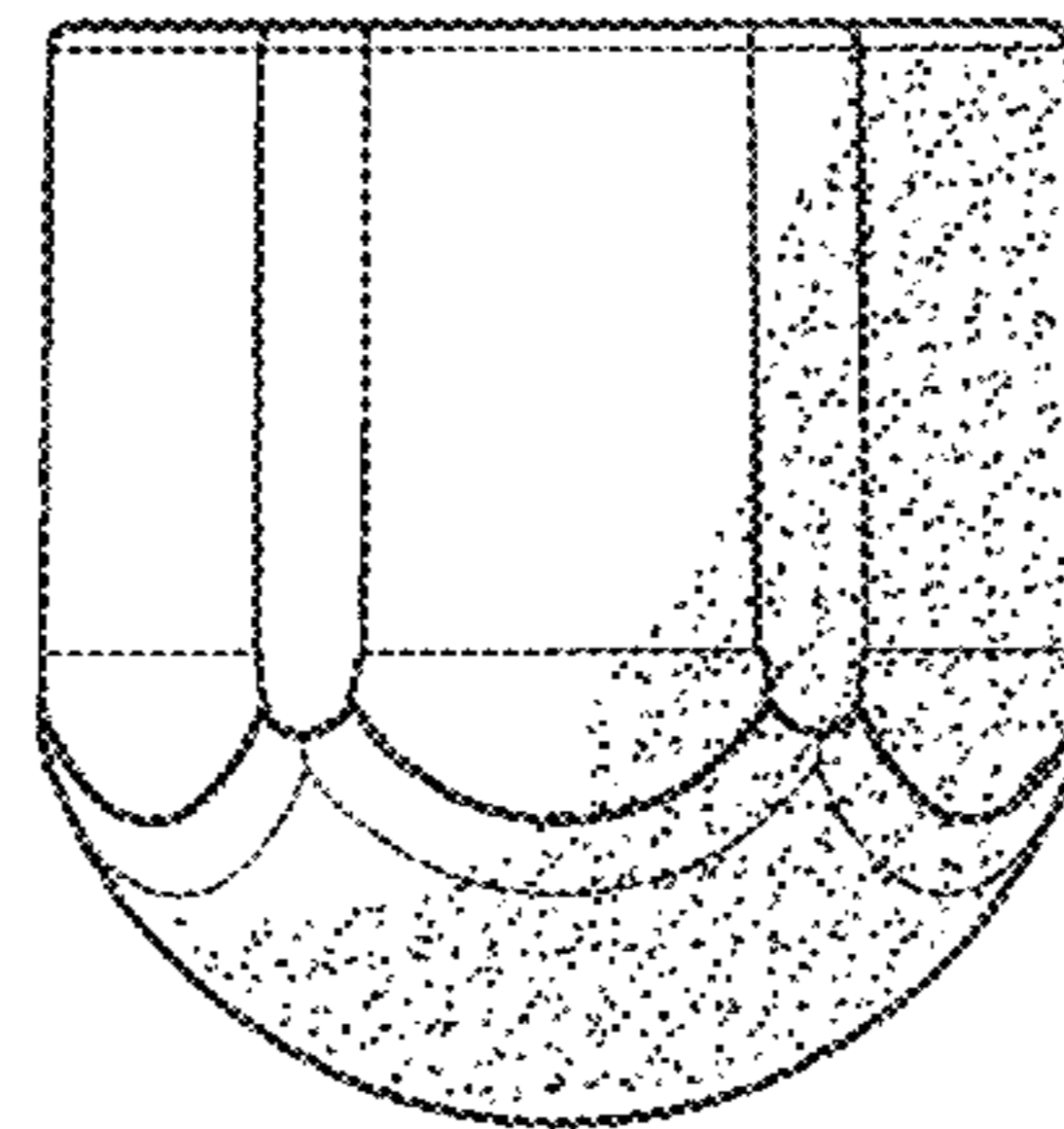

FIG. 8

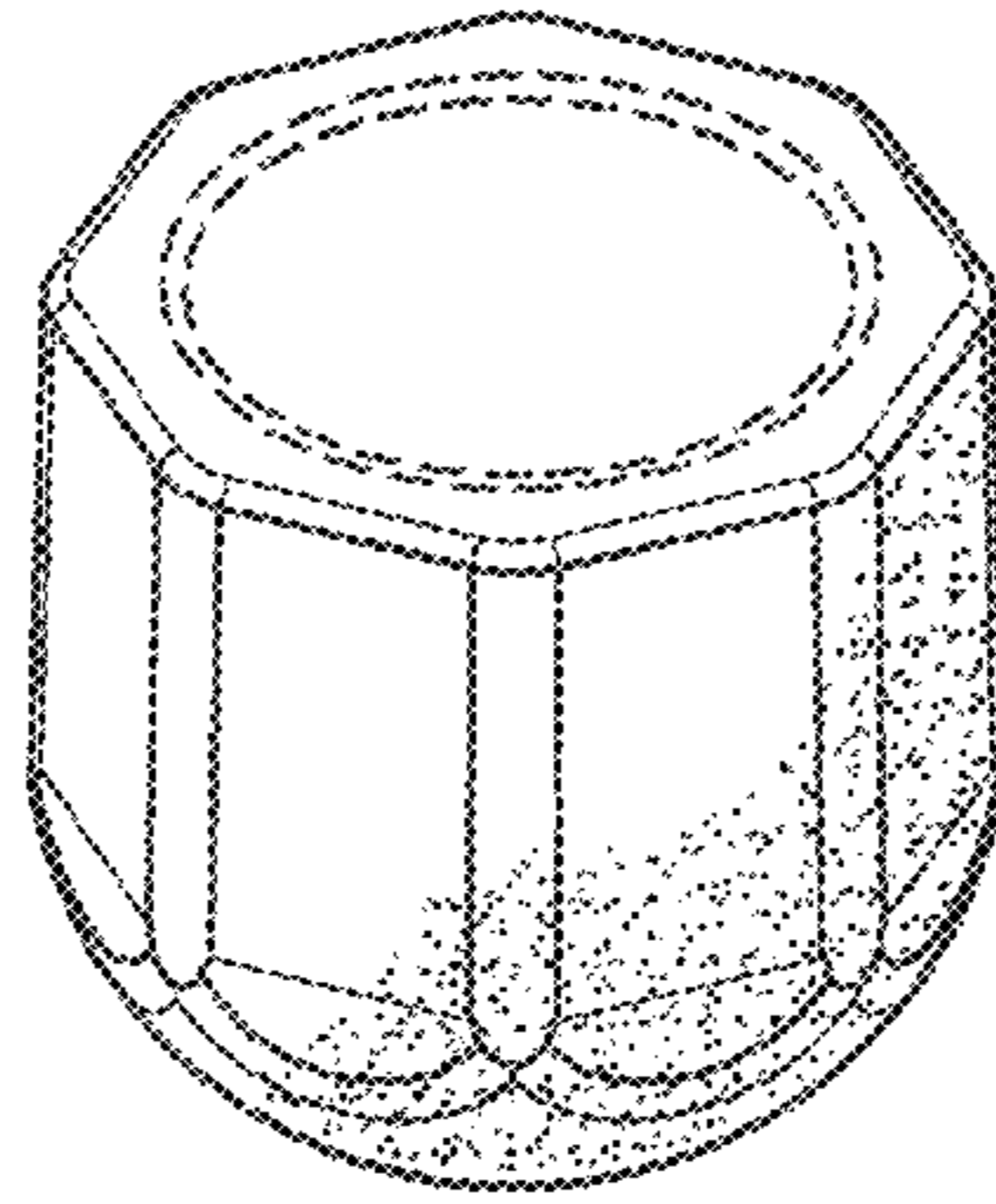

FIG. 9

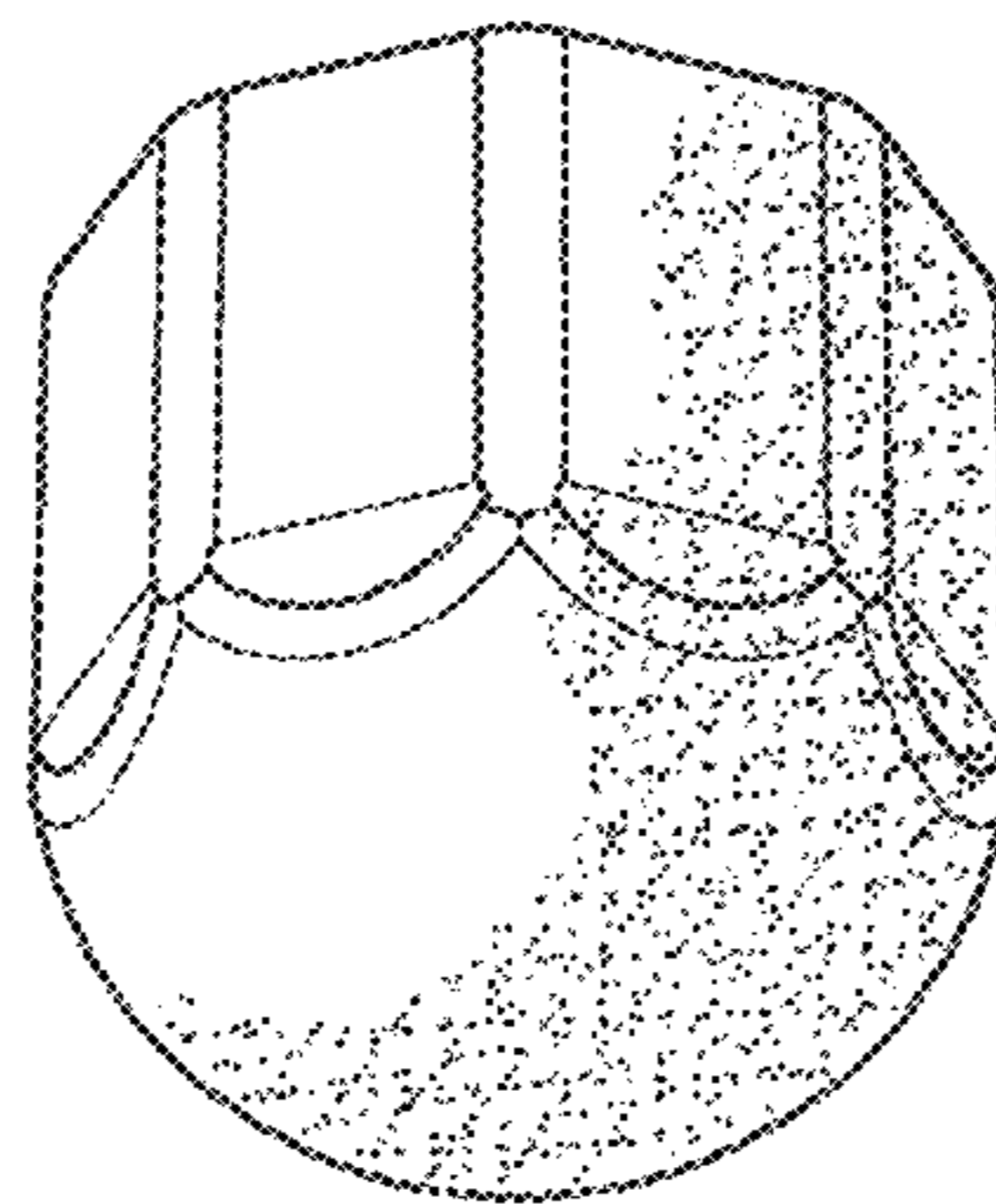

FIG. 10

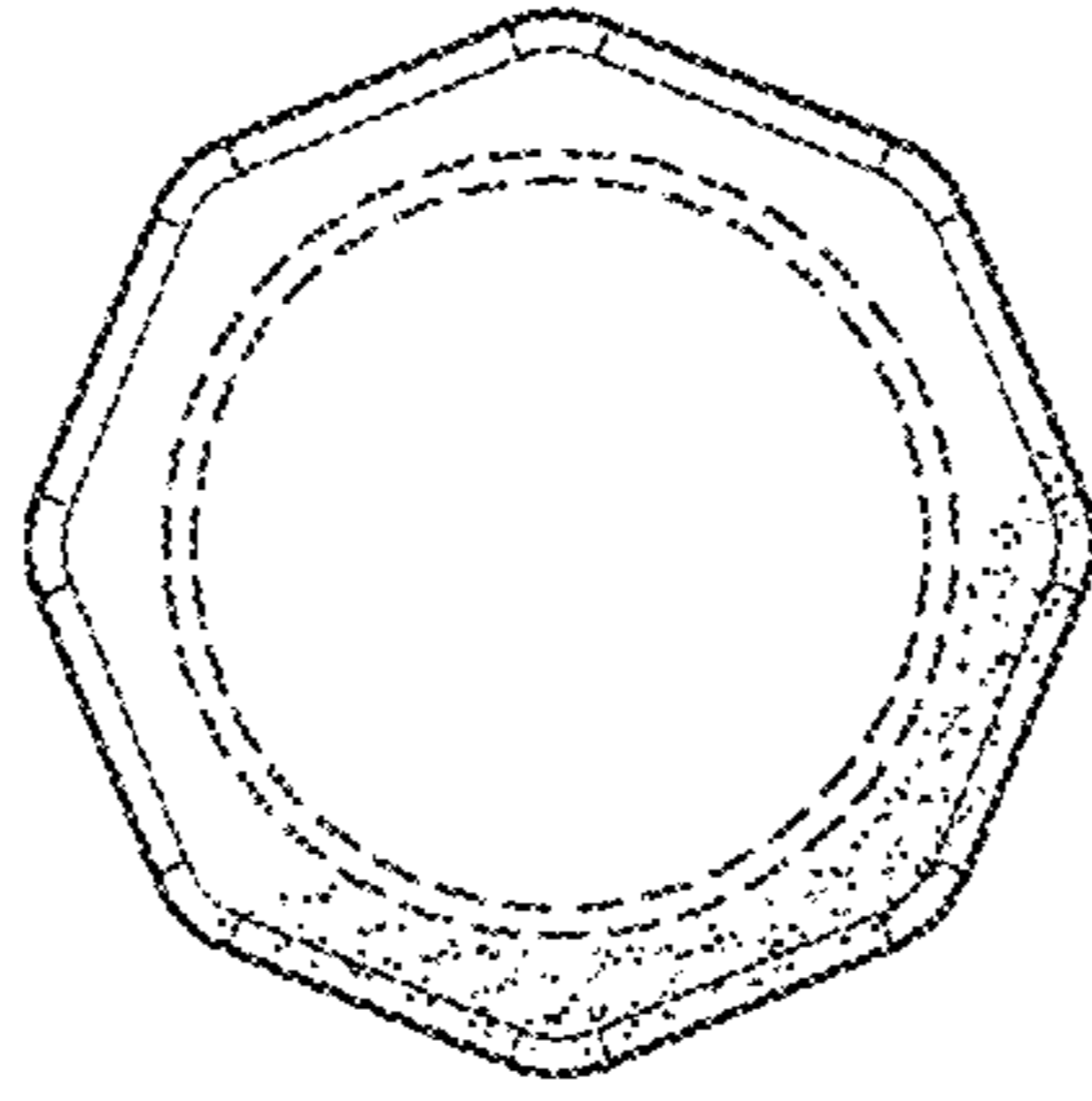

FIG. 11

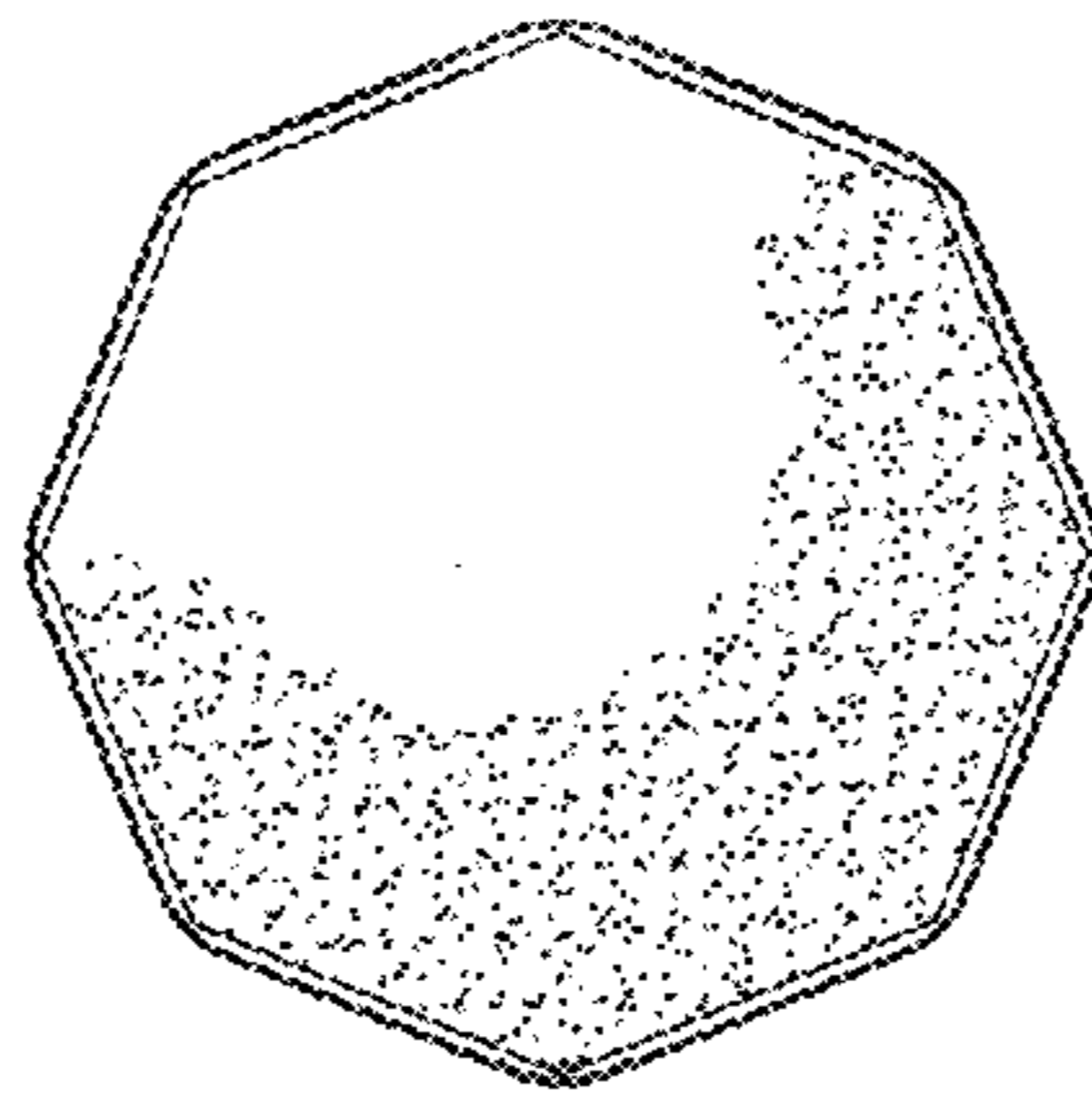

FIG. 12

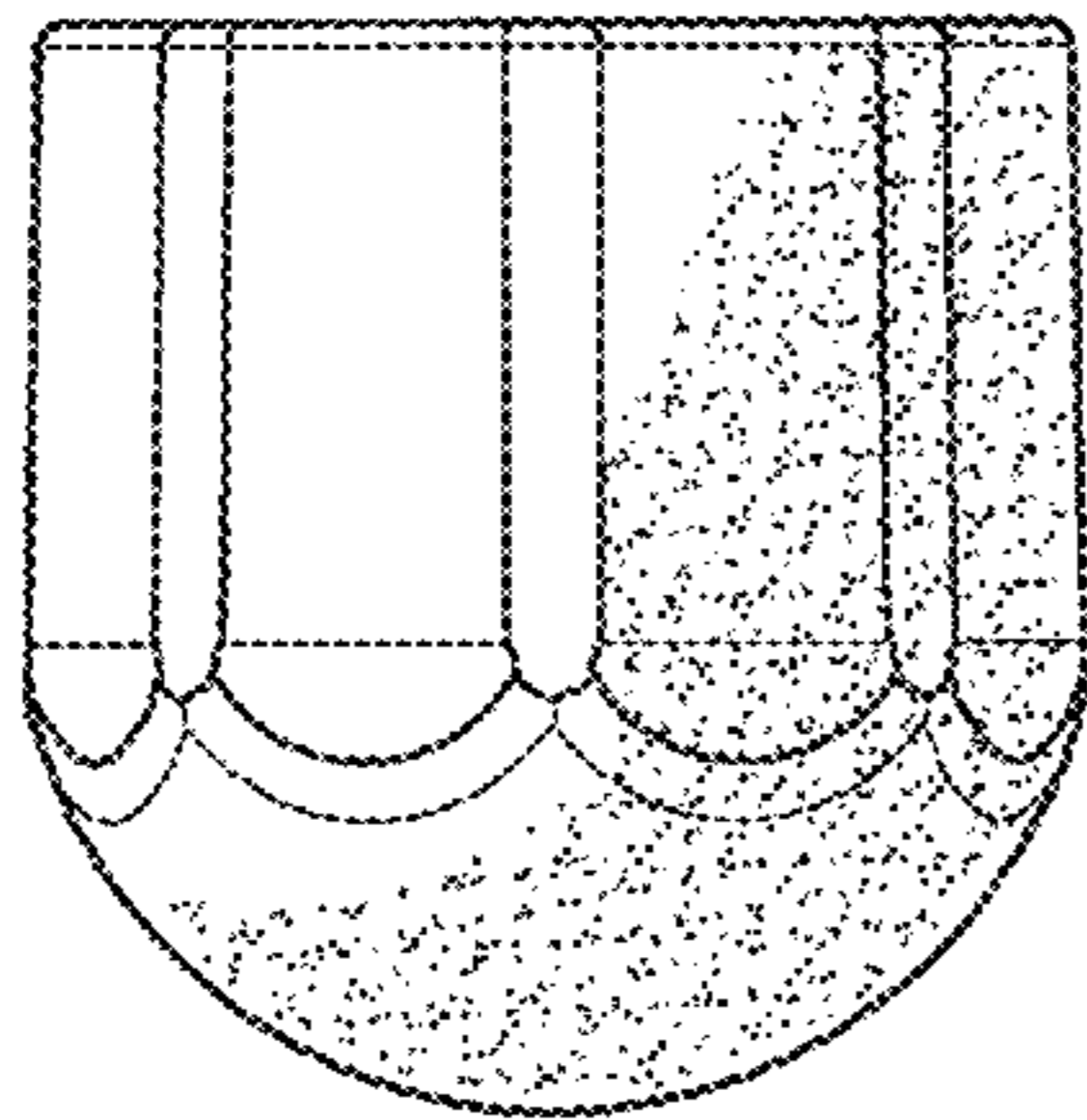

FIG. 13

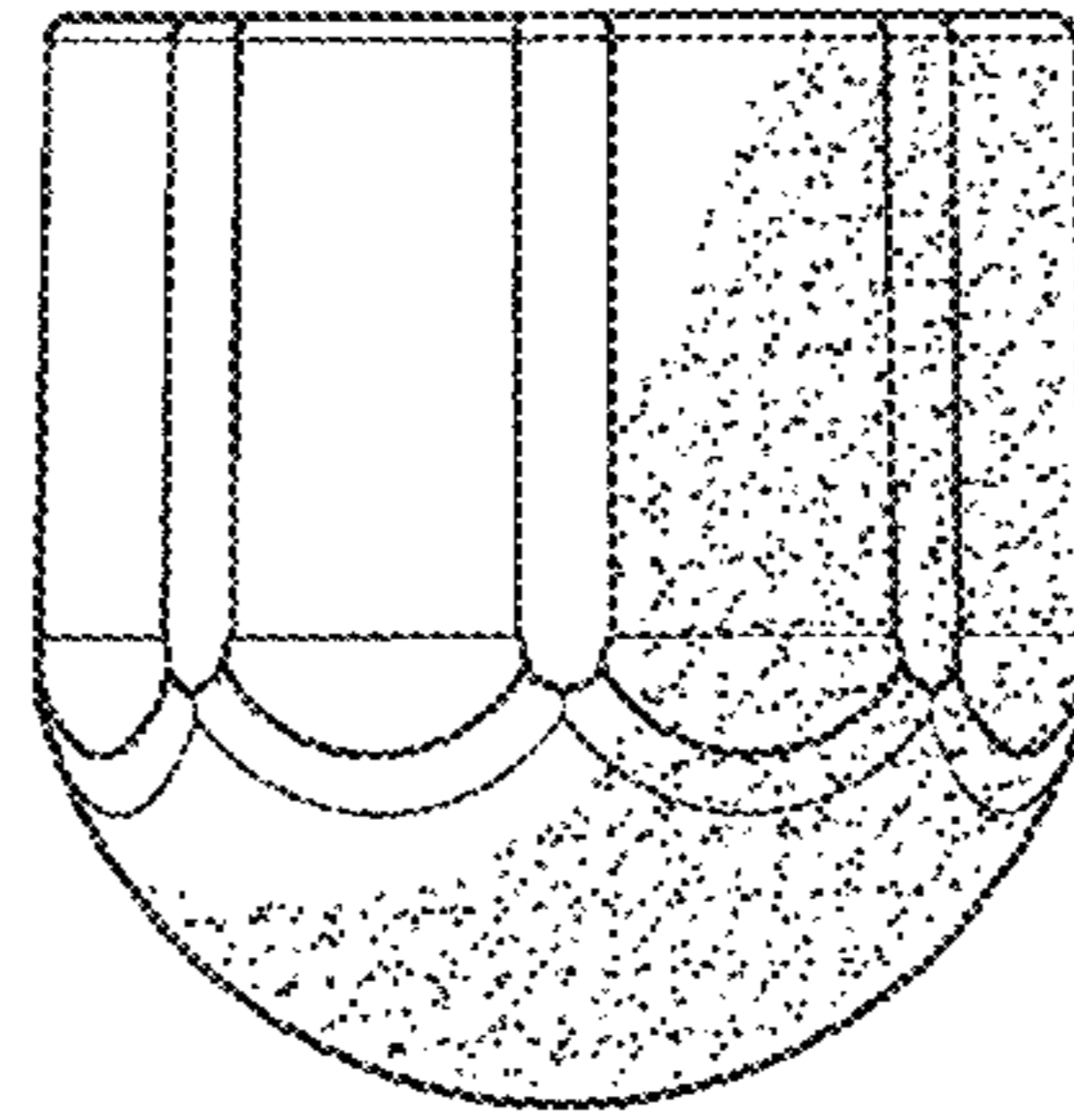

FIG. 14

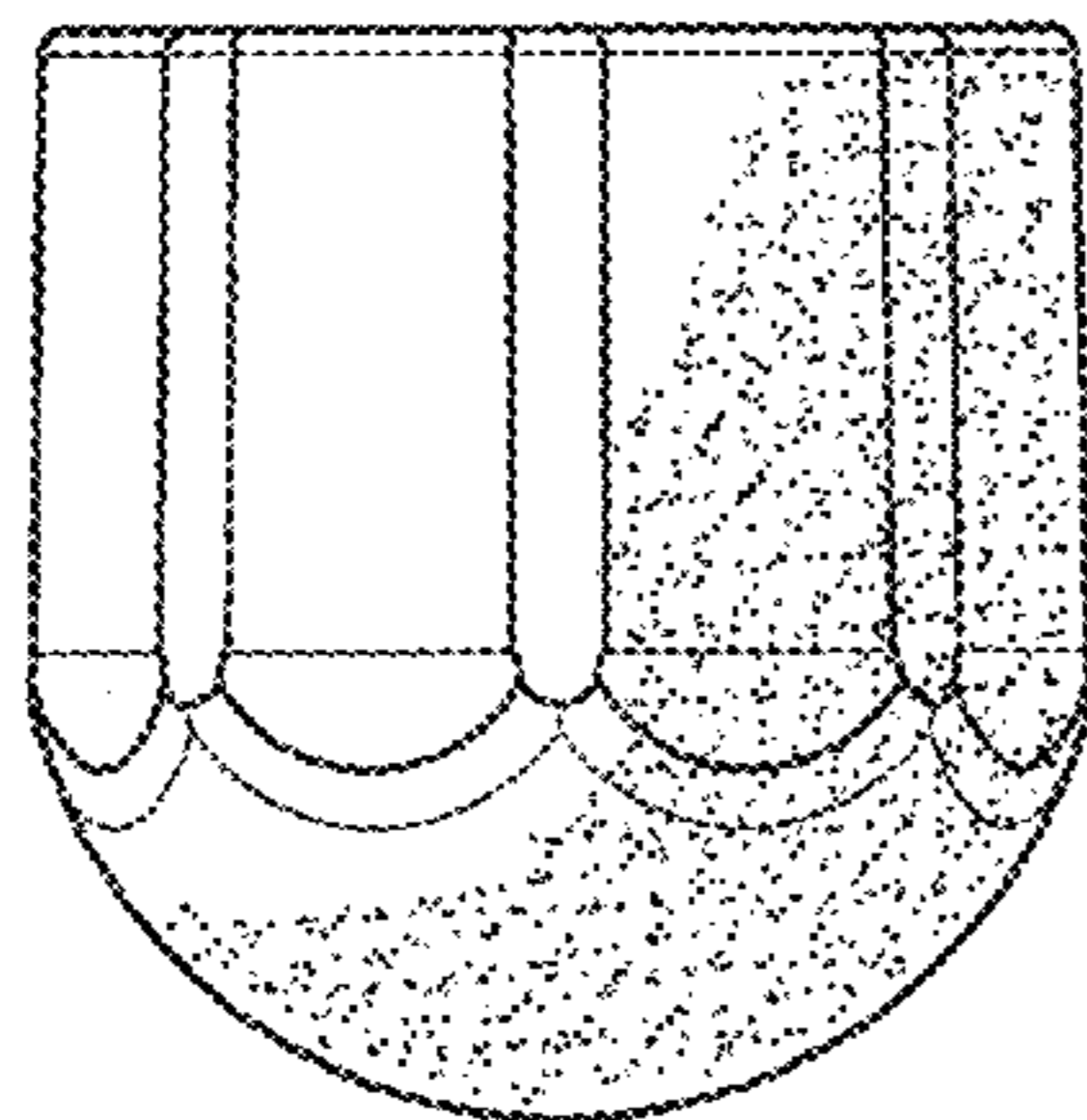

FIG. 15

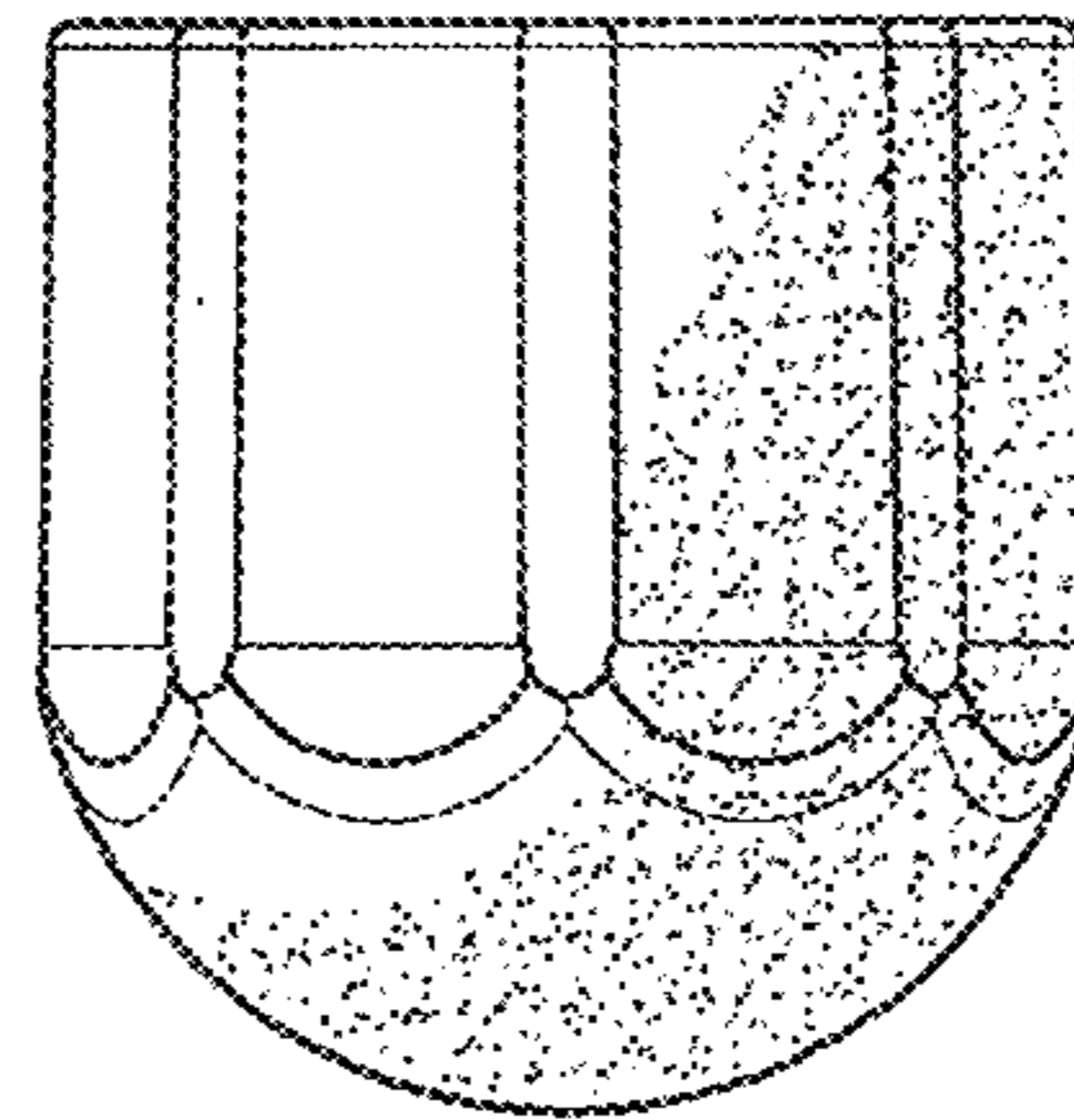

FIG. 16

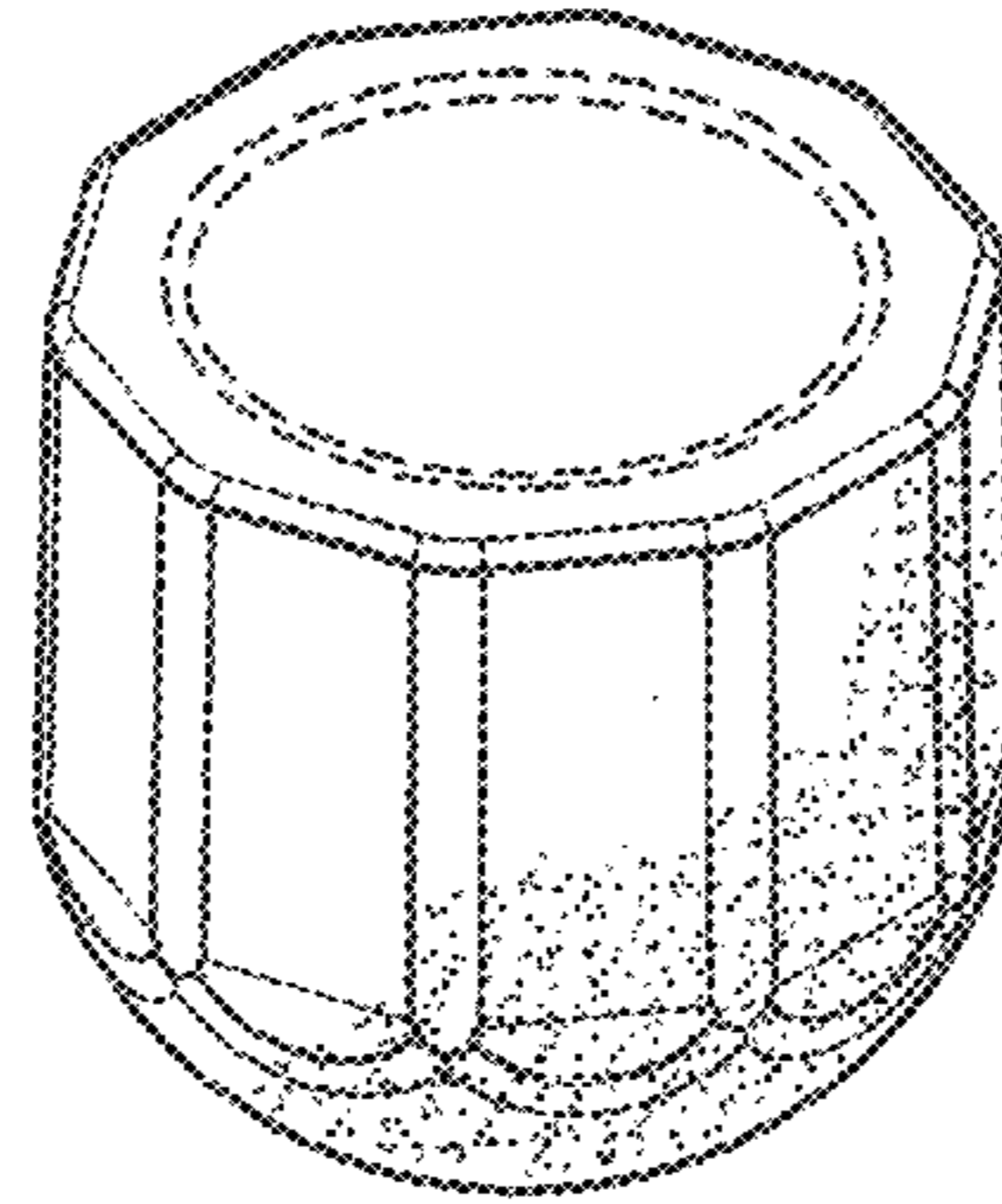

FIG. 17

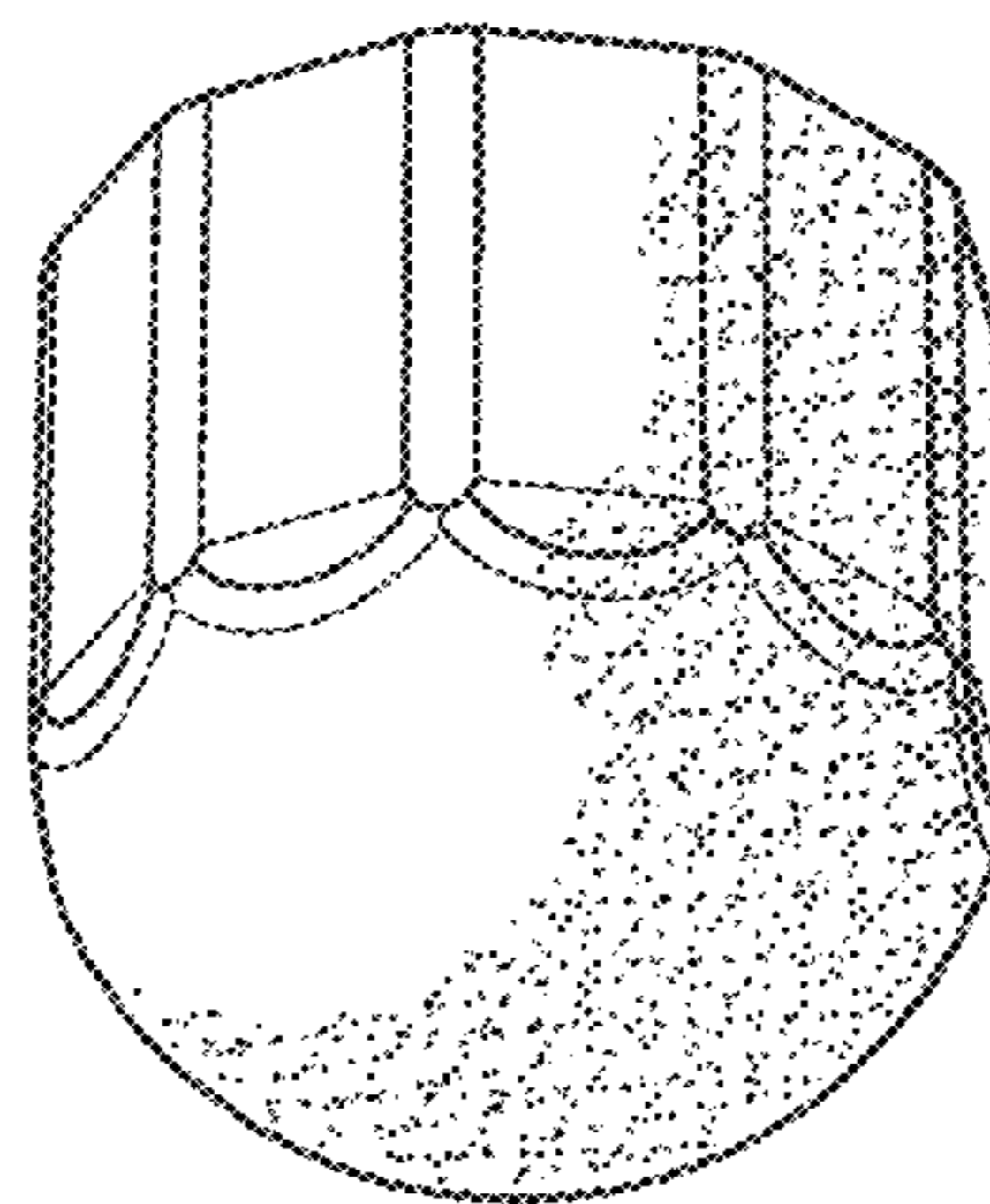

FIG. 18

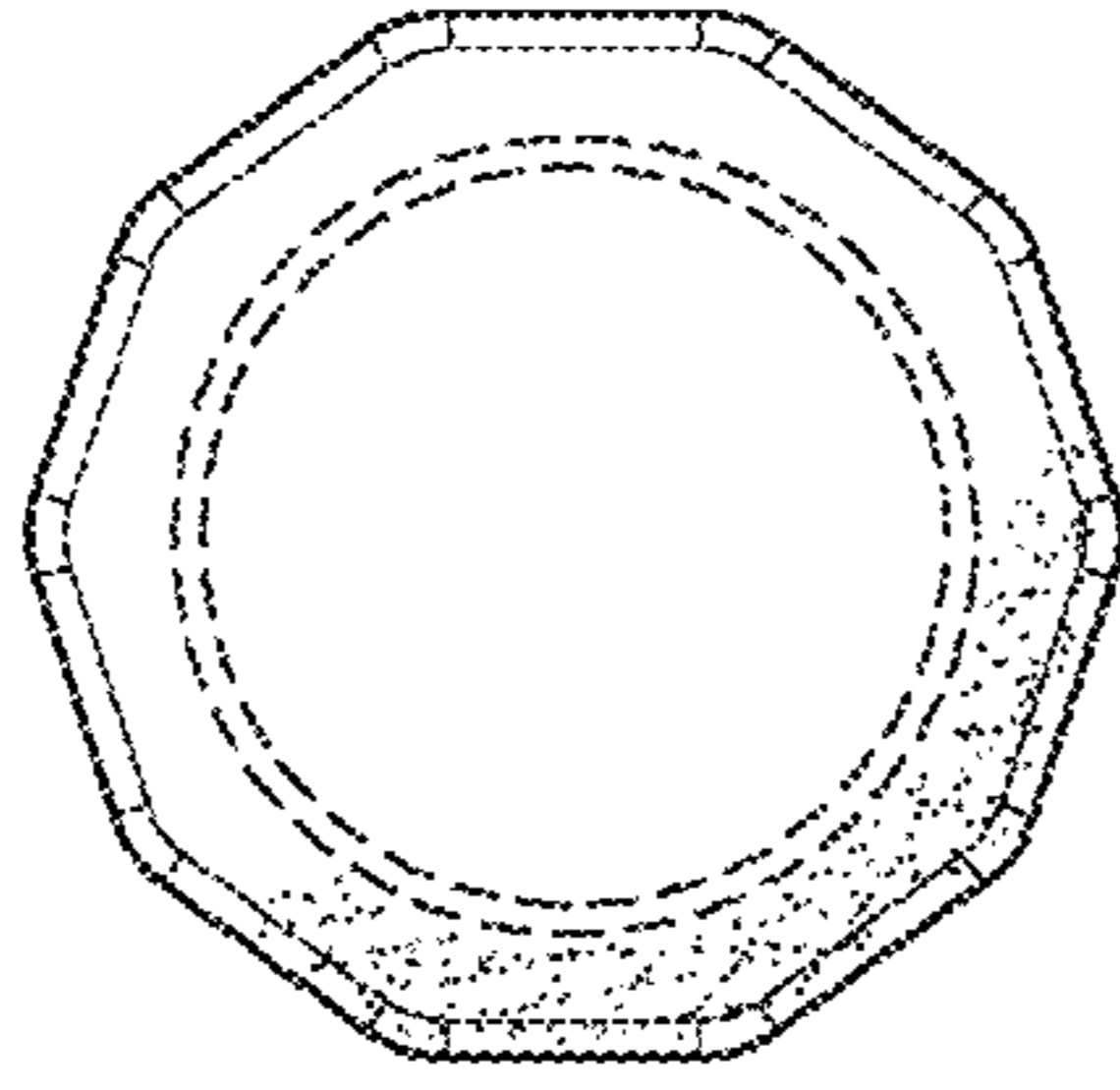

FIG. 19

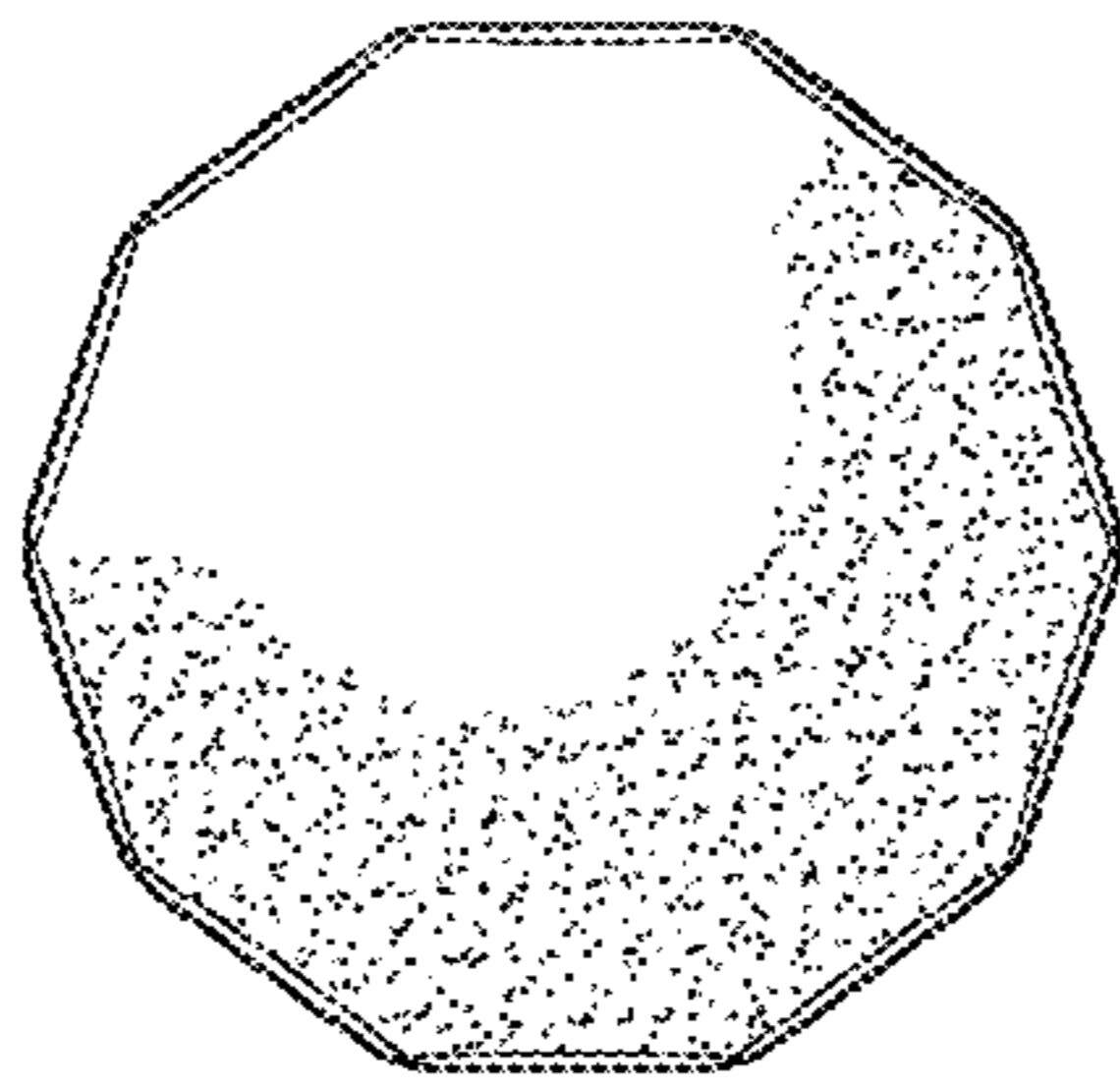

FIG. 20

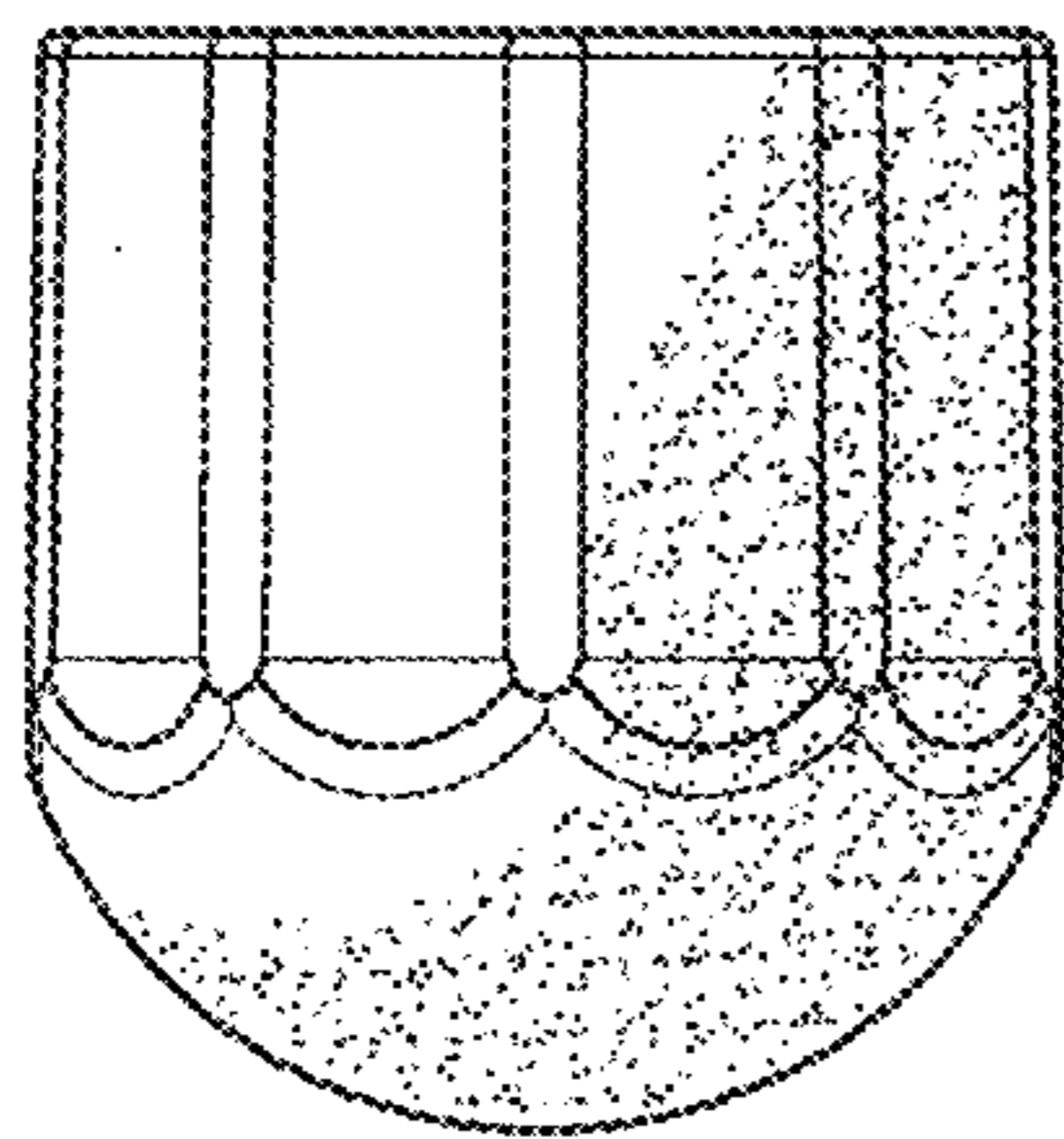

FIG. 21

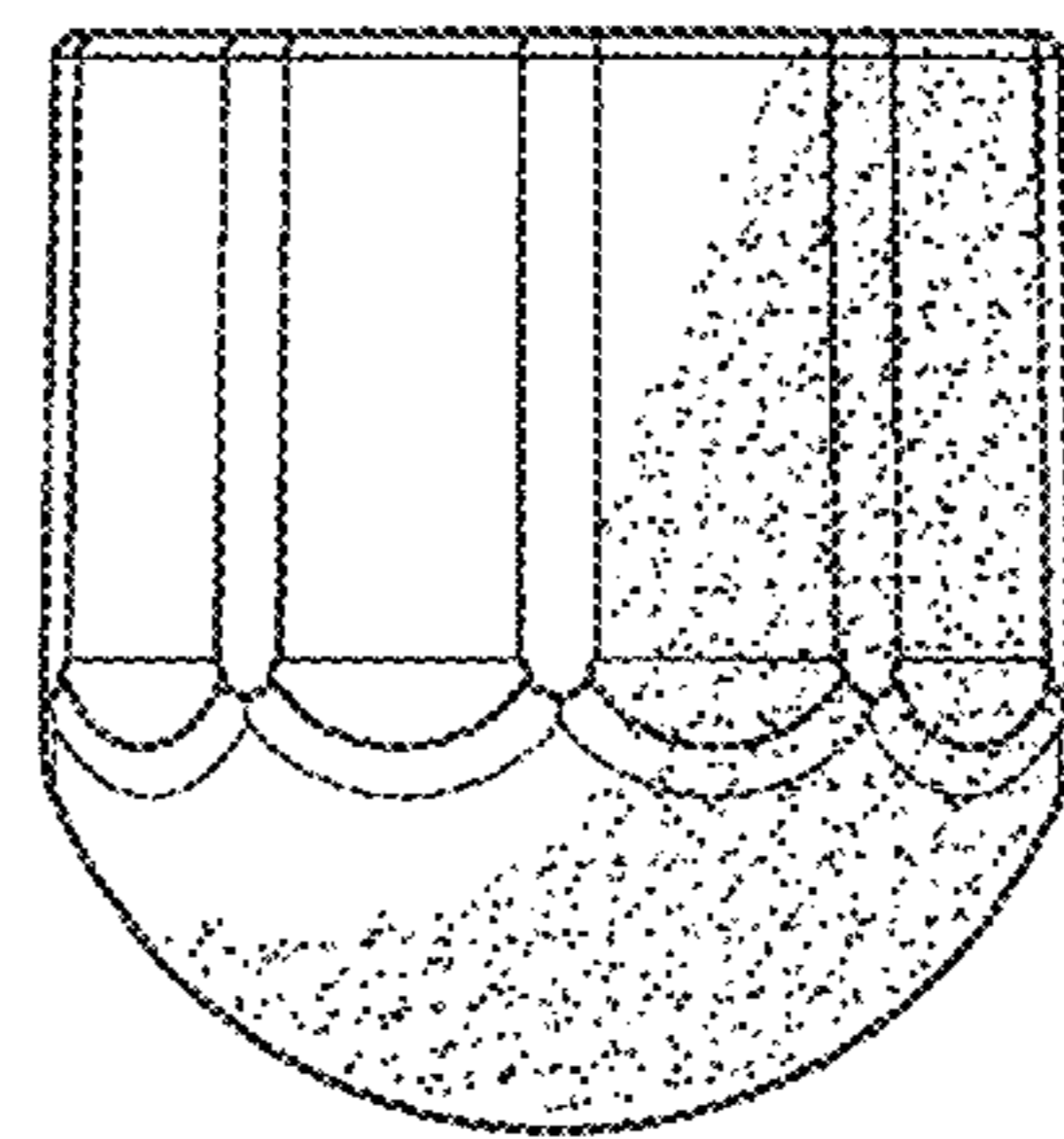

FIG. 22

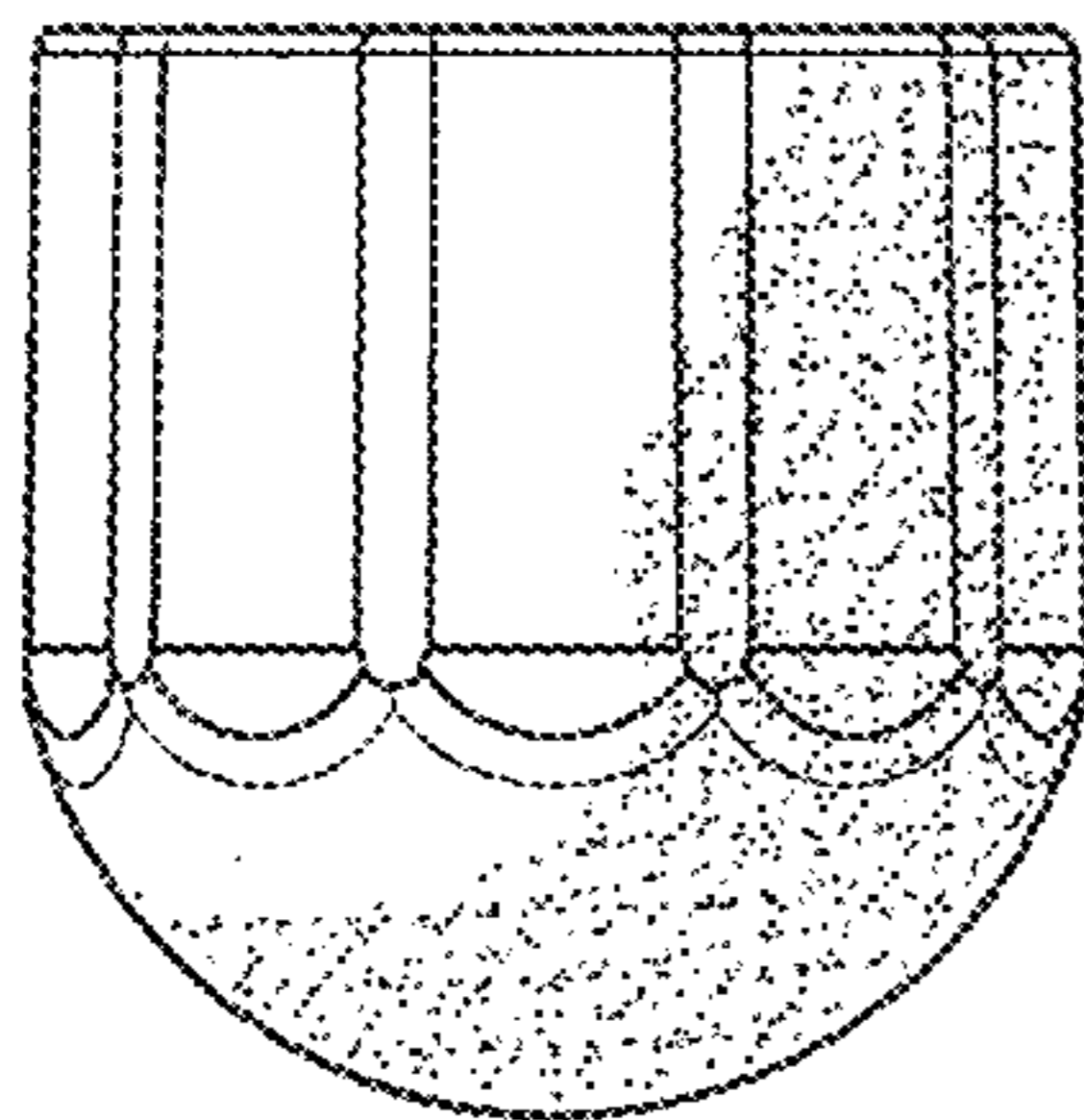

FIG. 23

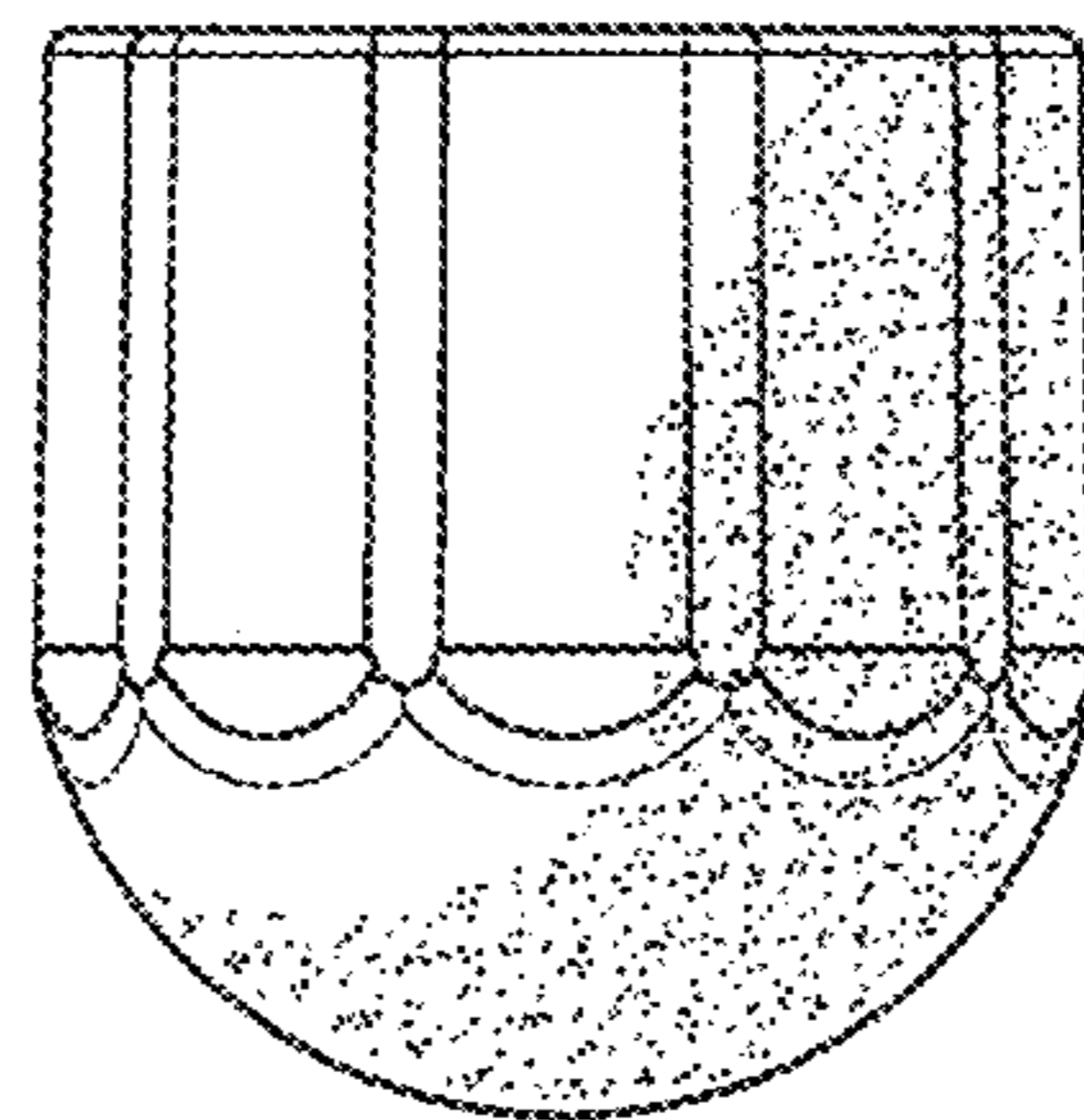

FIG. 24

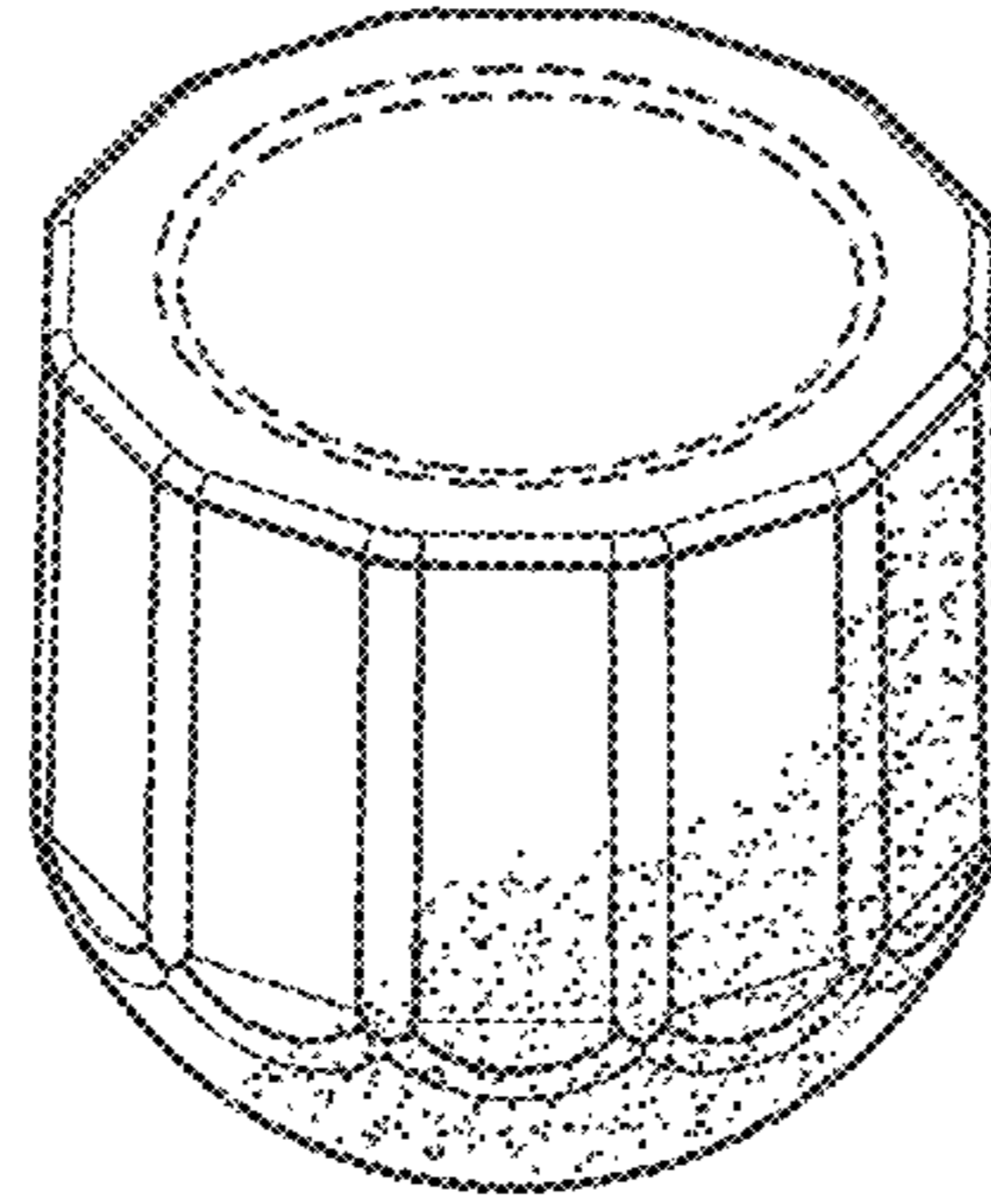

FIG. 25

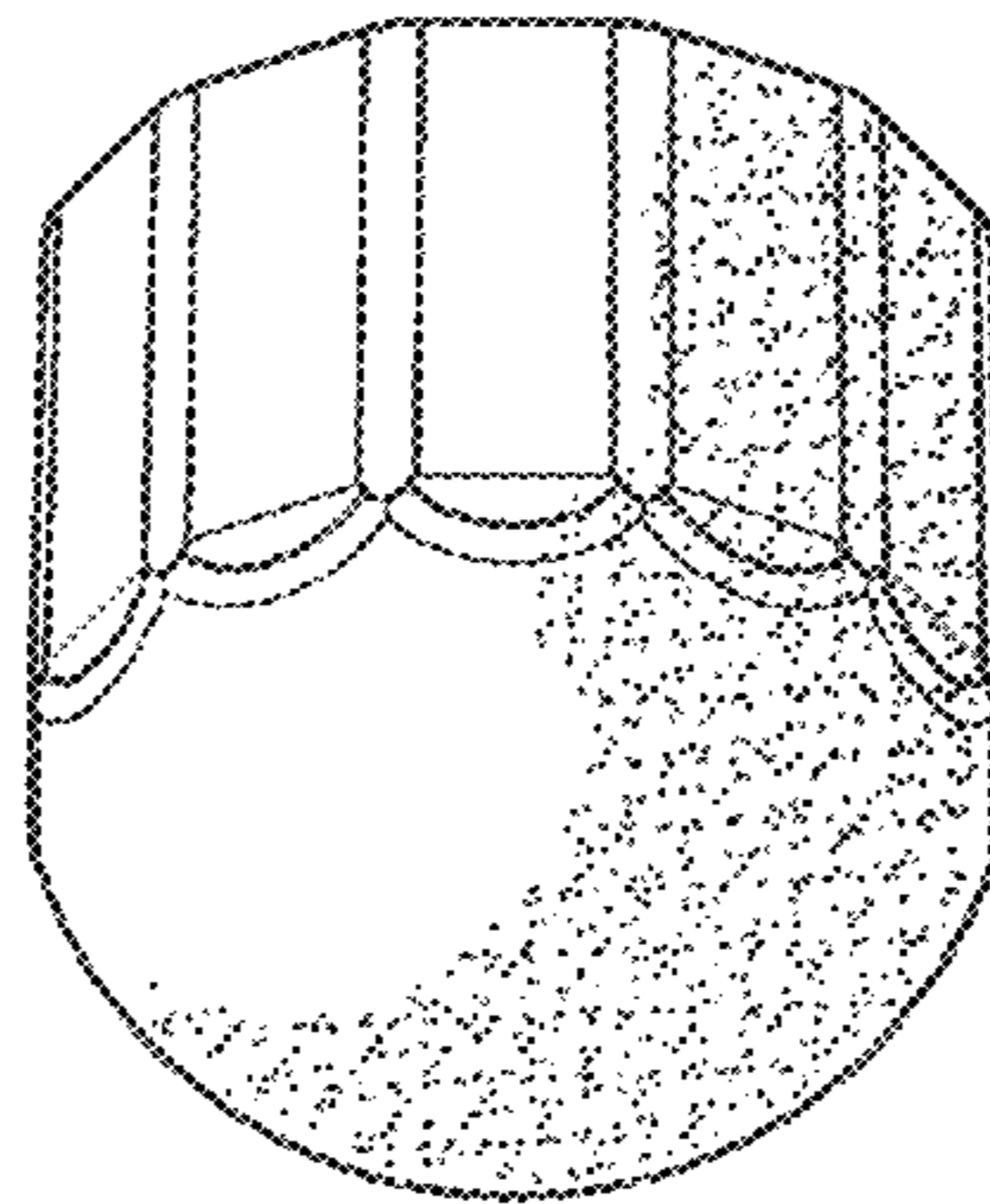

FIG. 26

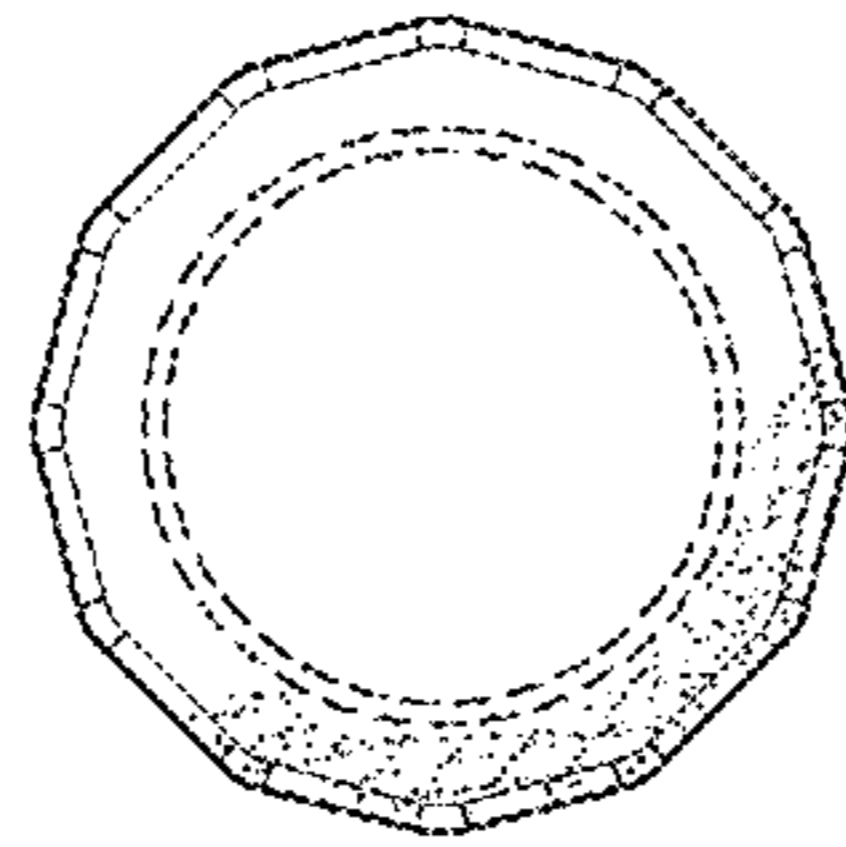

FIG. 27

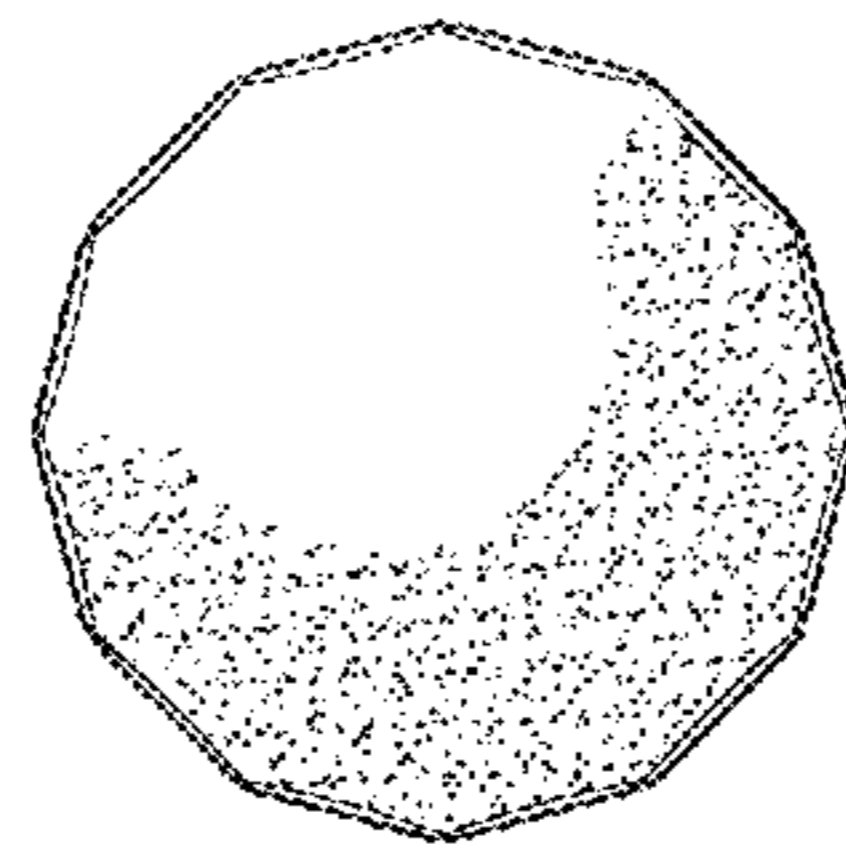

FIG. 28

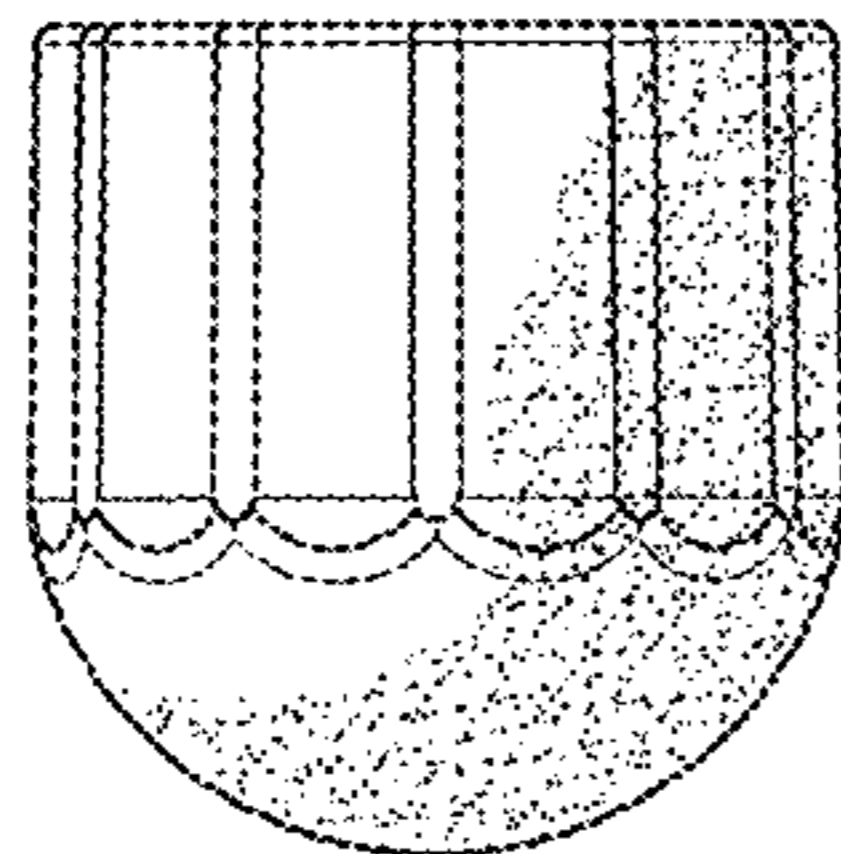

FIG. 29

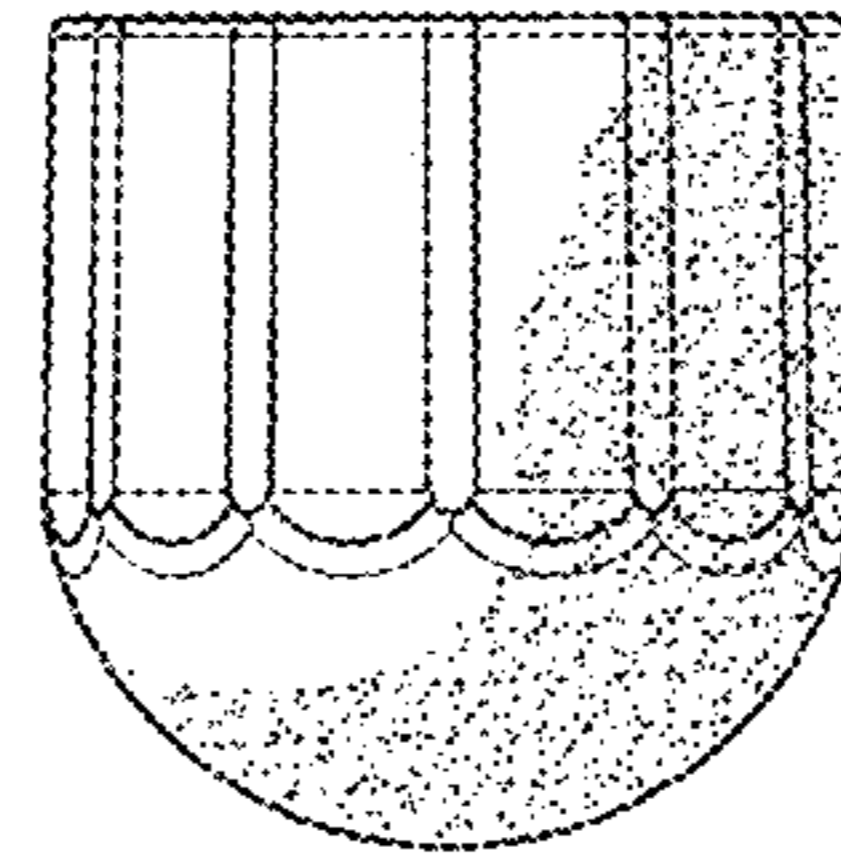

FIG. 30

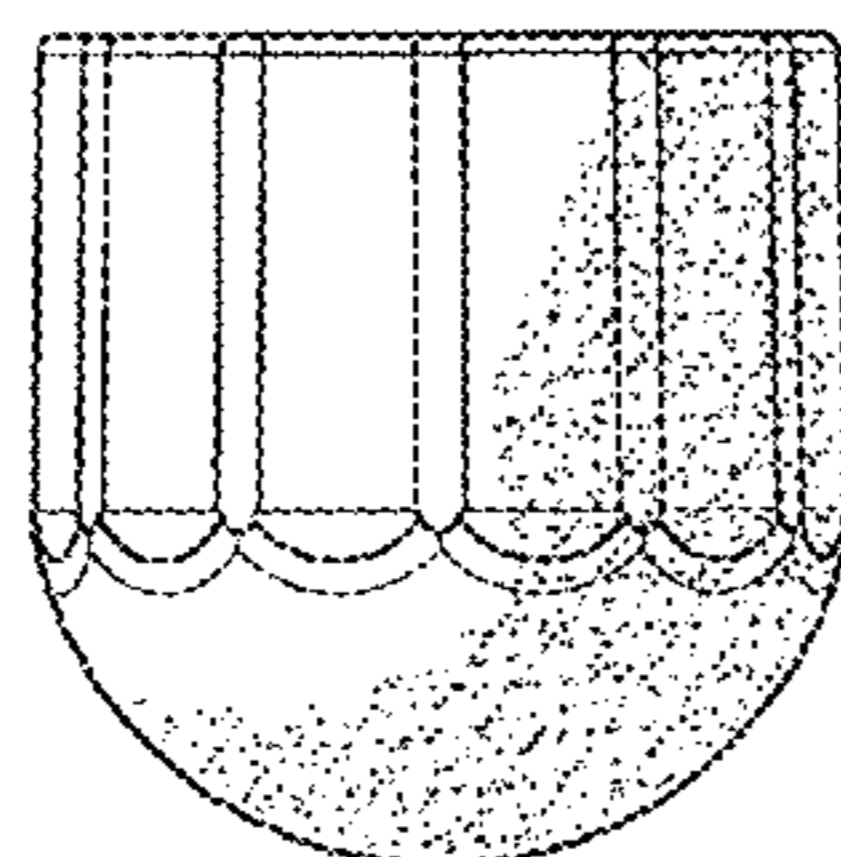

FIG. 31

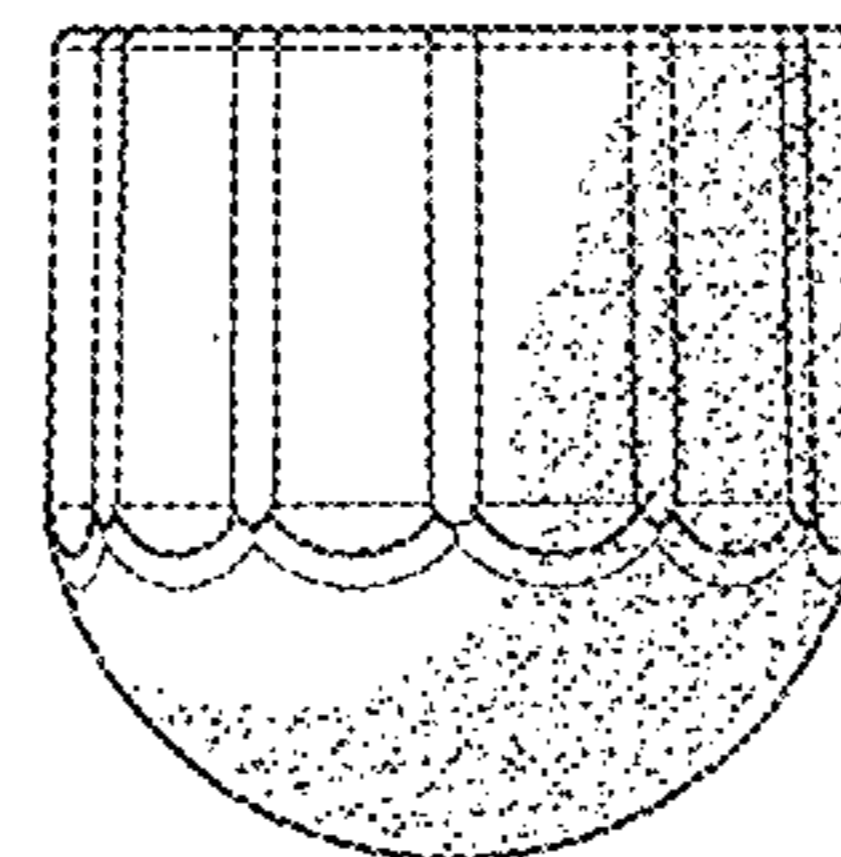

FIG. 32