



US00D795216S

(12) **United States Design Patent**  
**Poandl**

(10) **Patent No.:** **US D795,216 S**

(45) **Date of Patent:** **\*\* Aug. 22, 2017**

(54) **CLOCK RADIO WITH SLANTED SIDES**

(71) Applicant: **HTI Industries LLC**, Rahway, NJ (US)

(72) Inventor: **Mary Beth Poandl**, Red Bank, NJ (US)

(73) Assignee: **HTI Industries LLC**, Rahway, NJ (US)

(\*\*) Term: **15 Years**

(21) Appl. No.: **29/577,055**

(22) Filed: **Sep. 9, 2016**

(51) **LOC (10) Cl.** ..... **14-01**

(52) **U.S. Cl.**  
USPC ..... **D14/172; D14/170; D14/188**

(58) **Field of Classification Search**  
USPC ..... D14/137, 140, 142, 149, 155, 157, 158,  
D14/168, 170, 171, 188, 189,  
D14/203.1–203.8, 209.1, 224.1, 243, 251,  
D14/432, 447, 451, 496; 439/529, 534;  
455/90.1–90.3, 344–348, 556.1, 556.2;  
369/6–12; 370/342–344  
CPC ..... H04B 1/06; H04B 1/08; H04B 1/086;  
H04M 1/04; H04M 1/21; H04W 4/02;  
H04W 4/06; G08B 1/00; G04B 47/00  
See application file for complete search history.

(56) **References Cited**

**U.S. PATENT DOCUMENTS**

- 4,768,870 A \* 9/1988 Chen ..... B60R 1/12  
359/871
- D556,185 S \* 11/2007 Motoishi ..... D10/2

- D556,732 S \* 12/2007 Chan ..... D14/168
- D582,887 S \* 12/2008 Poandl ..... D14/172
- 7,710,831 B2 \* 5/2010 Driska ..... G04G 13/02  
368/10
- 8,036,067 B2 \* 10/2011 Stuart ..... G04G 13/026  
368/244
- D648,743 S \* 11/2011 Chang ..... D14/168
- D671,521 S \* 11/2012 Song ..... D14/168
- 8,384,527 B2 \* 2/2013 Irwin ..... G04G 13/02  
340/309.16
- D704,076 S \* 5/2014 Poandl ..... D10/15
- D726,682 S \* 4/2015 Kim ..... D14/170
- D773,431 S \* 12/2016 Holzer ..... D14/170

\* cited by examiner

*Primary Examiner* — Prabhakar Deshmukh

(74) *Attorney, Agent, or Firm* — Leason Ellis LLP

(57) **CLAIM**

The ornamental design for a clock radio with slanted sides, as shown and described.

**DESCRIPTION**

FIG. 1 is a front perspective view of a clock radio with slanted sides showing my new design;  
 FIG. 2 is a front elevational view thereof;  
 FIG. 3 is a rear elevational view thereof;  
 FIG. 4 is a left side elevational view thereof;  
 FIG. 5 is a right side elevational view thereof;  
 FIG. 6 is a top plan view thereof; and,  
 FIG. 7 is a bottom plan view thereof.  
 The broken lines illustrate unclaimed portions and form no part of the claimed design.

**1 Claim, 7 Drawing Sheets**

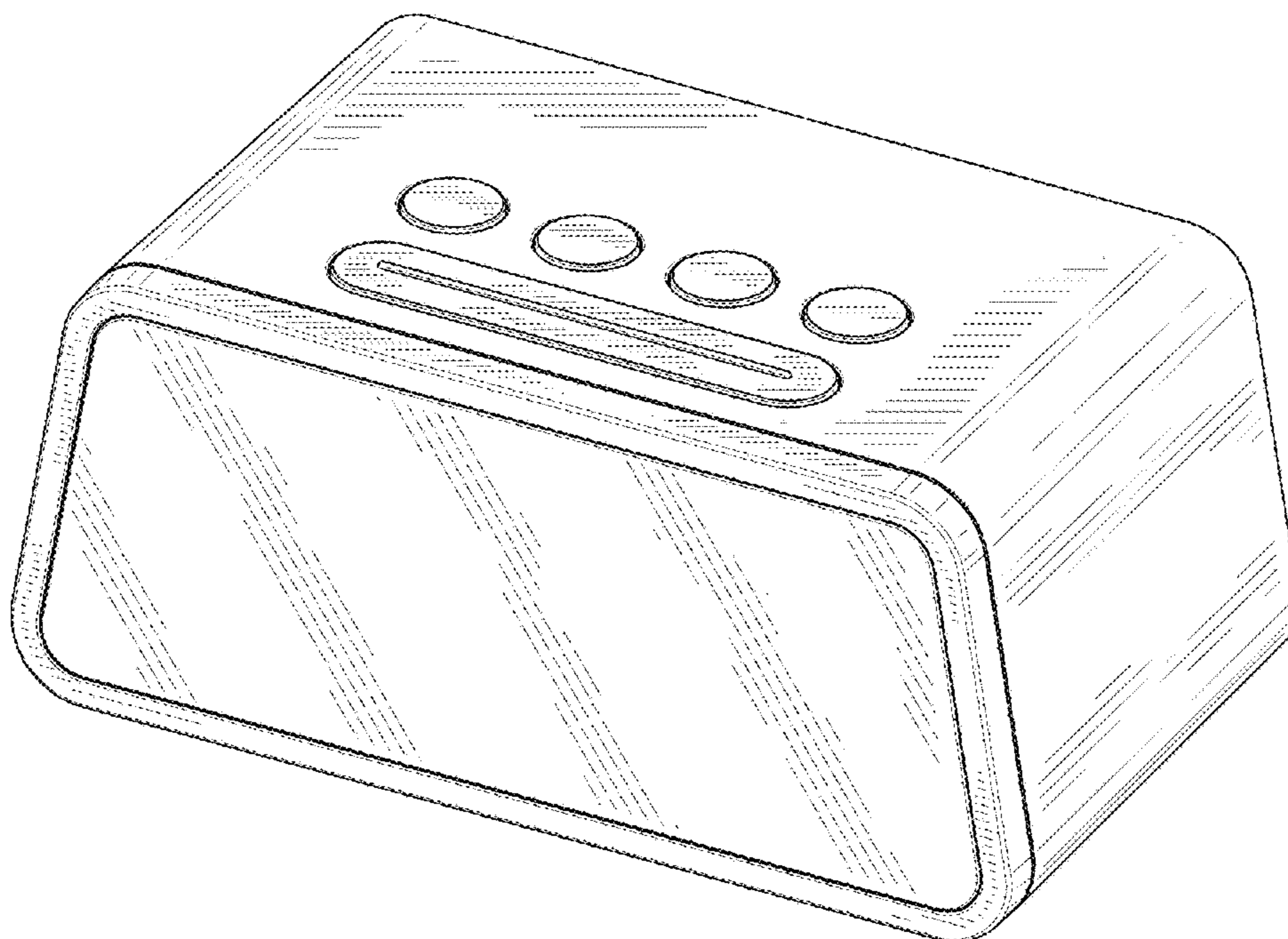

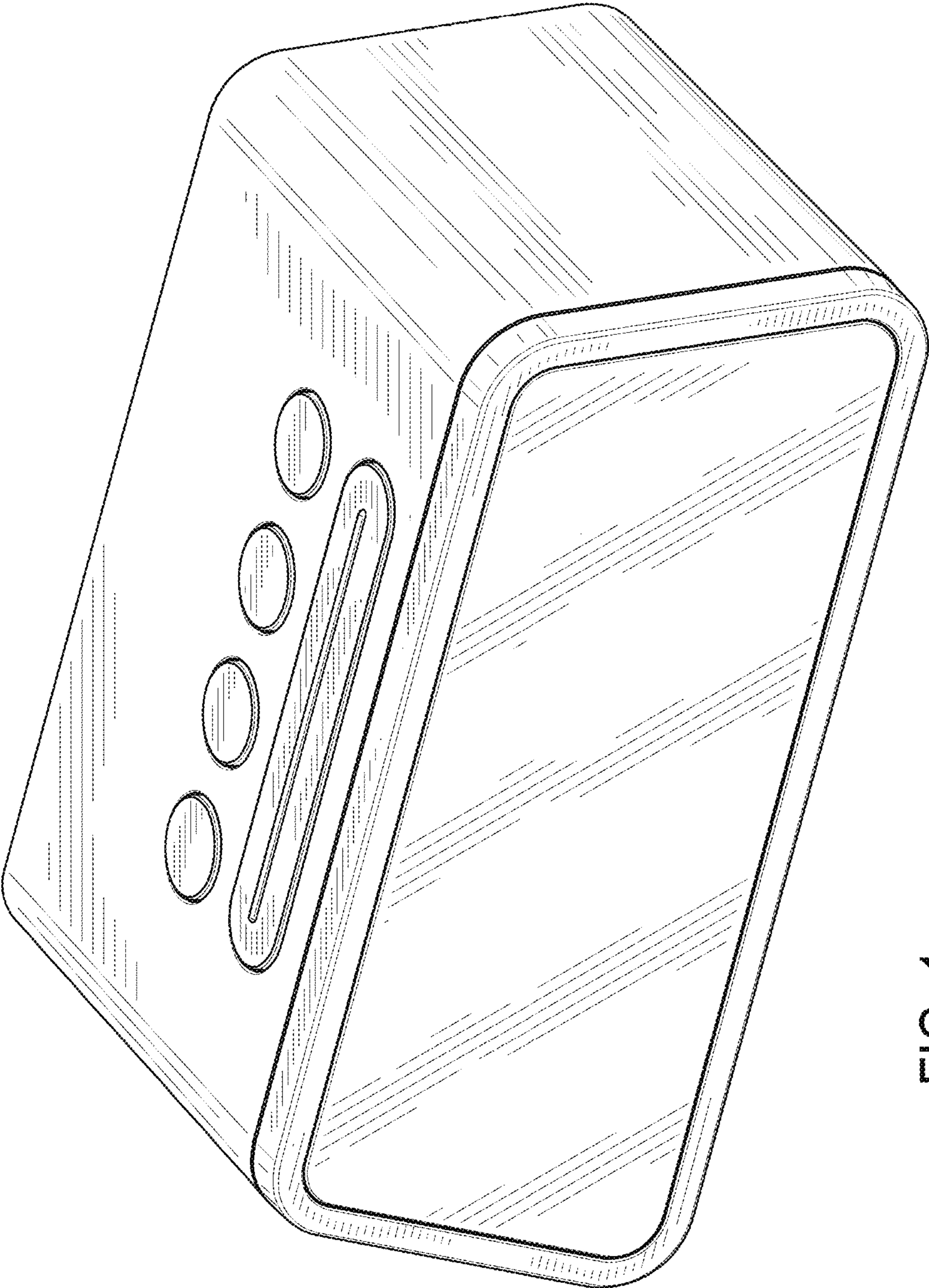

FIG. 1

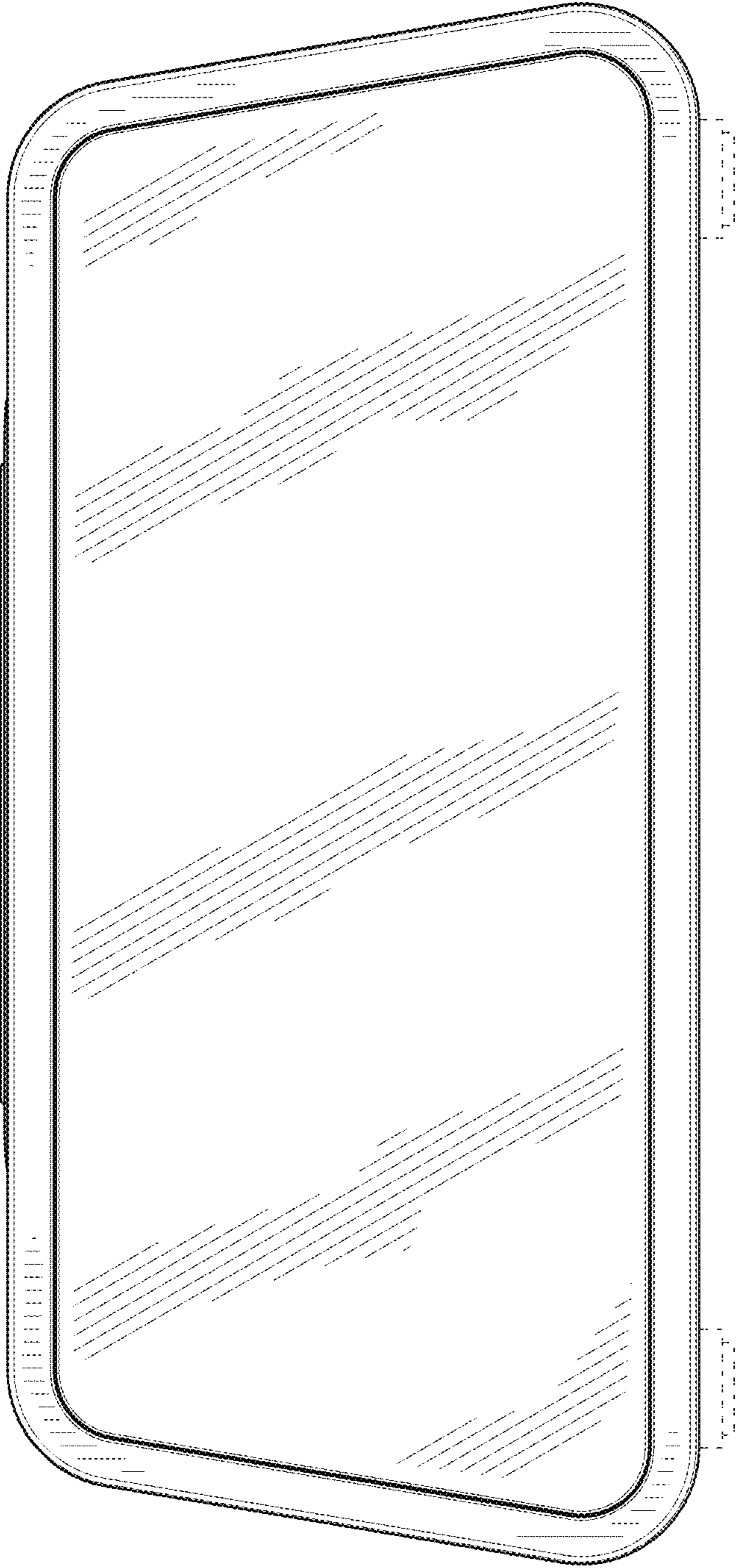

FIG. 2

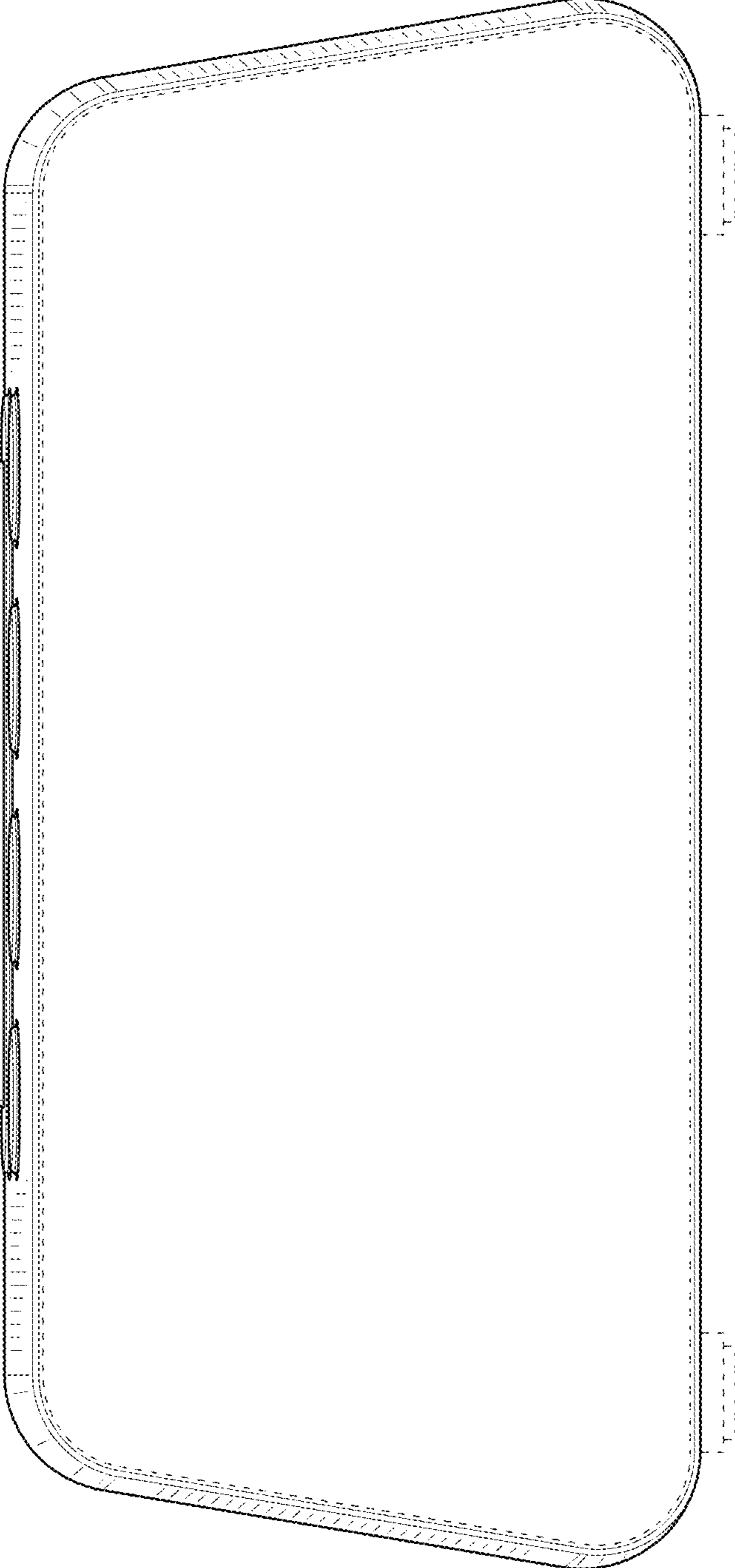

FIG. 3



FIG. 4



FIG. 5

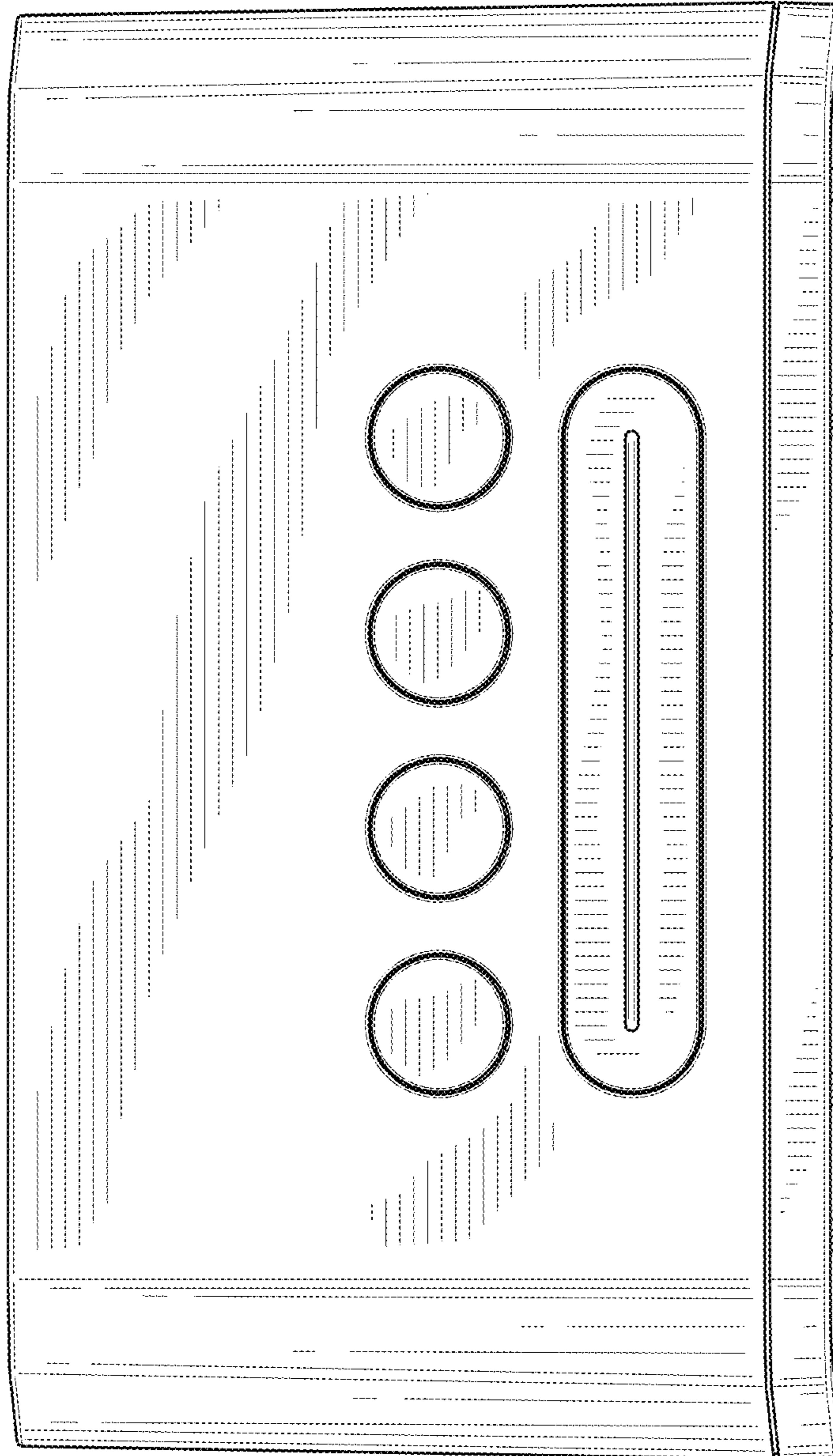

FIG. 6

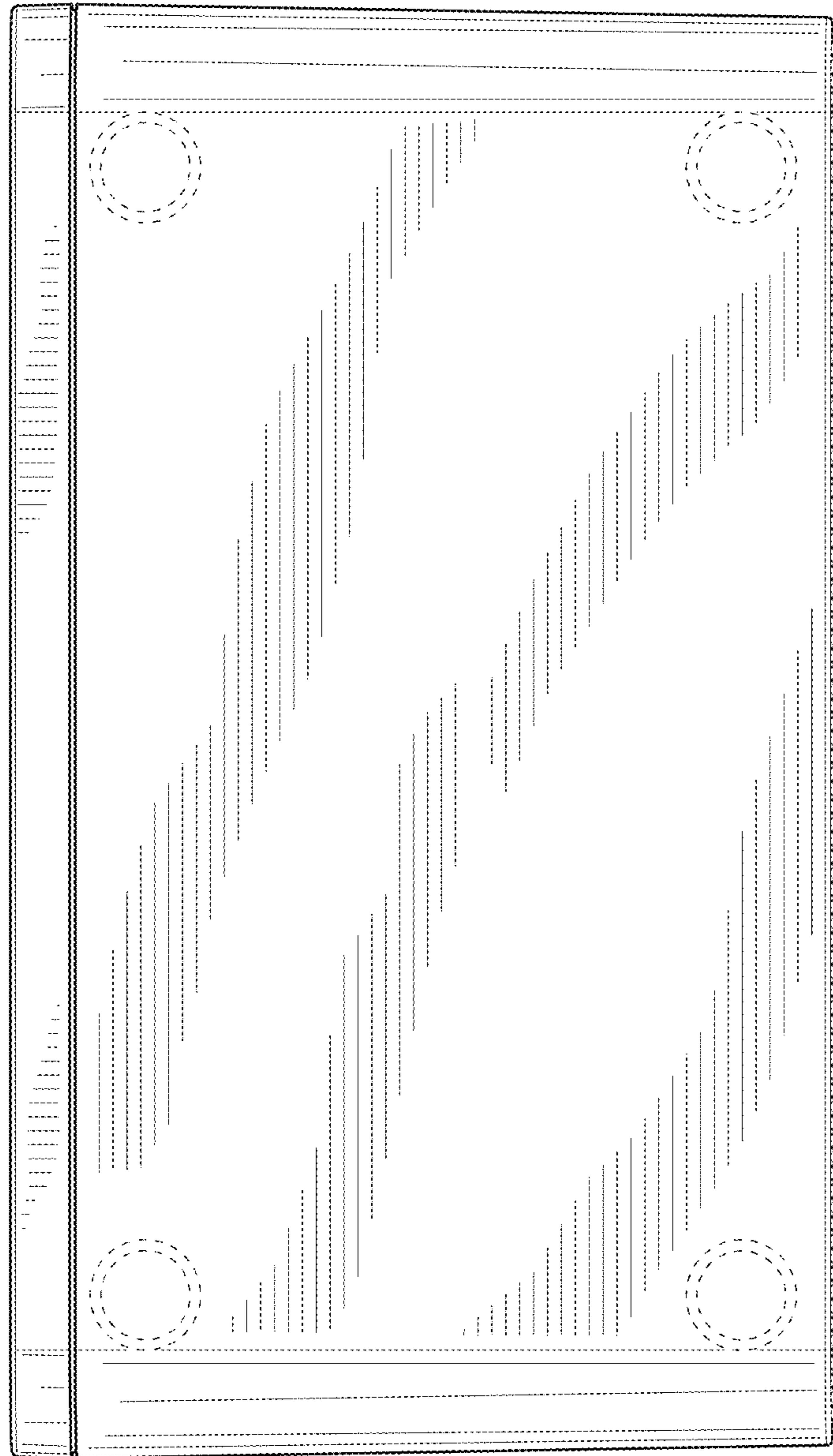

FIG. 7