



US00D795211S

(12) **United States Design Patent** (10) **Patent No.:** **US D795,211 S**
Franck et al. (45) **Date of Patent:** **** Aug. 22, 2017**

(54) **ENCLOSURE DOOR**
(71) Applicant: **Wirepath Home Systems, LLC**,
Charlotte, NC (US)
(72) Inventors: **Christopher Glenn Franck**, Fort Mill,
SC (US); **William Jacob Kozlowski,**
Jr., Waxhaw, NC (US); **Jamie Lee**
Quinlan, Charlotte, NC (US); **Matthew**
R. Shute, Huntersville, NC (US)
(73) Assignee: **WIREPATH HOME SYSTEMS,**
LLC, Charlotte, NC (US)
(**) Term: **15 Years**

(21) Appl. No.: **29/529,777**
(22) Filed: **Jun. 10, 2015**
(51) **LOC (10) Cl.** **13-03**
(52) **U.S. Cl.**
USPC **D13/184**
(58) **Field of Classification Search**
USPC D13/133, 139.3, 139.4, 152, 156, 155,
D13/158, 160, 162, 184, 199
CPC ... H04W 4/008; H04W 12/06; H04W 76/023;
H04W 12/08; H04W 24/02; H04W 64/00;
H04W 88/06; H04W 4/001; H04W
52/0216; H04W 84/045; H04W 84/12;
H04W 12/04; H04W 28/16; H04W 36/30;
H04W 4/00; H04W 4/005; H04W 4/02;
H04W 4/021; H04W 60/00; H04W 72/04;
H04W 72/0446; H04W 72/0453; H04W
76/021; H04W 76/028; H04W 12/02;
H04W 24/10; H04W 28/08; H04W 28/24;
H04W 36/0016; H04W 36/0055; H04W
36/0088; H04W 36/08; H04W 36/14;
H04W 36/22; H04W 36/32; H04W
(Continued)

(56) **References Cited**
U.S. PATENT DOCUMENTS
5,907,127 A * 5/1999 Daoud H02G 3/14
174/57
D437,586 S * 2/2001 Sonntag D13/184
(Continued)

Primary Examiner — Ian Simmons
Assistant Examiner — Khawaja Anwar
(74) *Attorney, Agent, or Firm* — Myers Bigel, P.A.

(57) **CLAIM**

The ornamental design for an enclosure door, as shown and described.

DESCRIPTION

FIG. 1 is a front perspective view illustrating an enclosure door;
FIG. 2 is a front view thereof;
FIG. 3 is a back view thereof;
FIG. 4 is a side view thereof;
FIG. 5 is an opposing side view thereof;
FIG. 6 is a top view thereof;
FIG. 7 is a bottom view thereof;
FIG. 8 is a front perspective view illustrating another embodiment of an enclosure door;
FIG. 9 is a front view thereof;
FIG. 10 is a back view thereof;
FIG. 11 is a side view thereof;
FIG. 12 is an opposing side view thereof;
FIG. 13 is a top view thereof;
FIG. 14 is a bottom view thereof;
FIG. 15 is a front perspective view illustrating another embodiment of an enclosure door;
FIG. 16 is a front view thereof;
FIG. 17 is a back view thereof;
FIG. 18 is a side view thereof;
FIG. 19 is an opposing side view thereof;
FIG. 20 is a top view thereof; and
FIG. 21 is a bottom view thereof.

The broken lines shown herein are for illustrative purposes only and form no part of the claimed design.

1 Claim, 15 Drawing Sheets

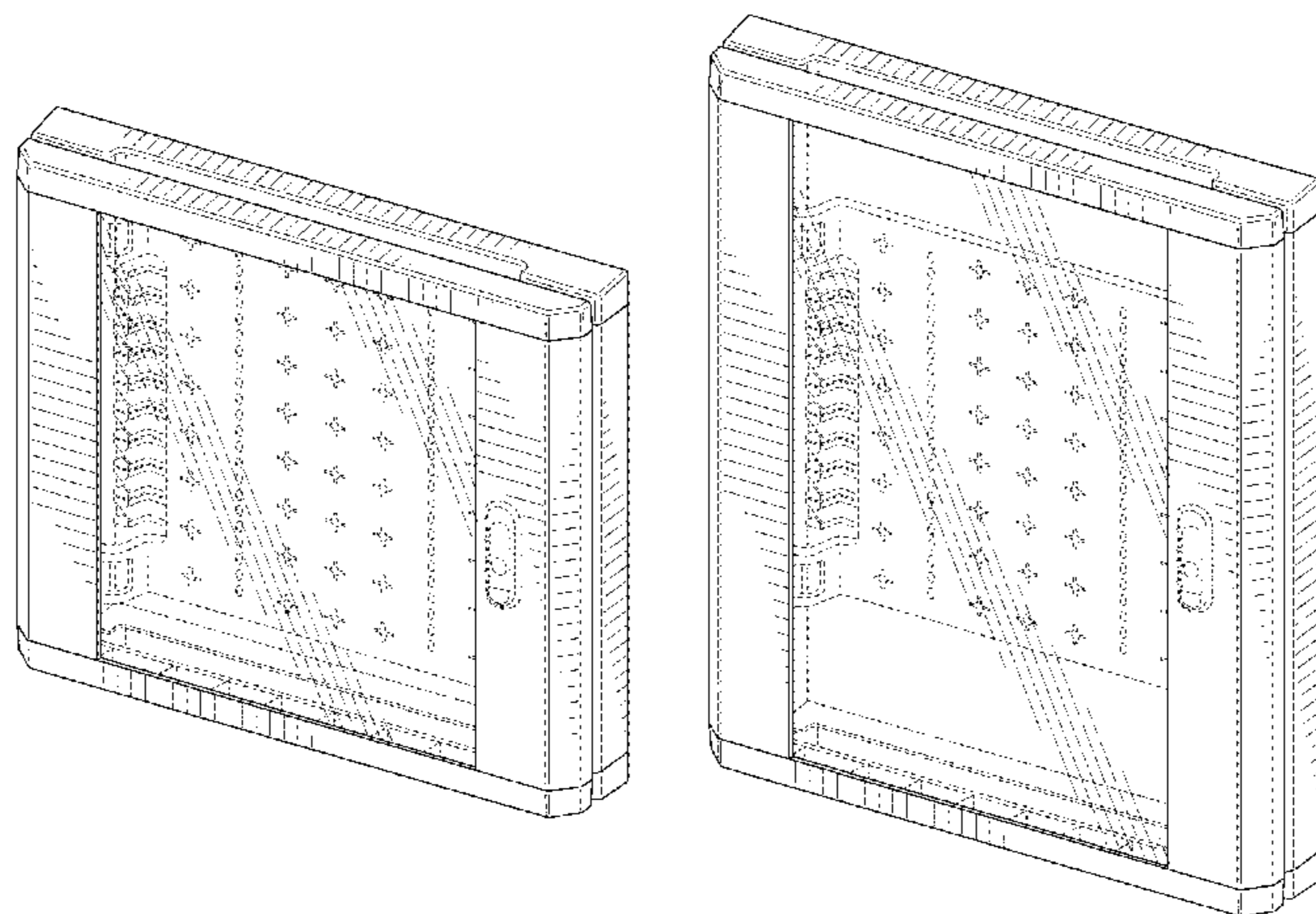

(58) **Field of Classification Search**

CPC . 52/0274; H04W 52/22; H04W 52/28; H04W
52/34; H04W 52/365; H04W 56/001;
H04W 56/004; H04W 56/0065; H04W
60/04; H04W 60/06; H04W 64/003;
H04W 64/006; H04W 72/005; H04W
72/0406; H04W 72/12; H04W 72/1252;
H04W 72/126

See application file for complete search history.

(56) **References Cited**

U.S. PATENT DOCUMENTS

6,467,640 B1 * 10/2002 Hung E05D 7/1011
174/50
D709,043 S * 7/2014 Isaacks D13/184
2002/0195261 A1 * 12/2002 Harrison H02B 1/44
174/50
2006/0233355 A1 * 10/2006 Markiewicz H04M 1/0293
379/413.04
2008/0197129 A1 * 8/2008 Gosche H05K 7/186
220/4.02
2009/0205864 A1 * 8/2009 McCarthy H02G 3/081
174/481

* cited by examiner

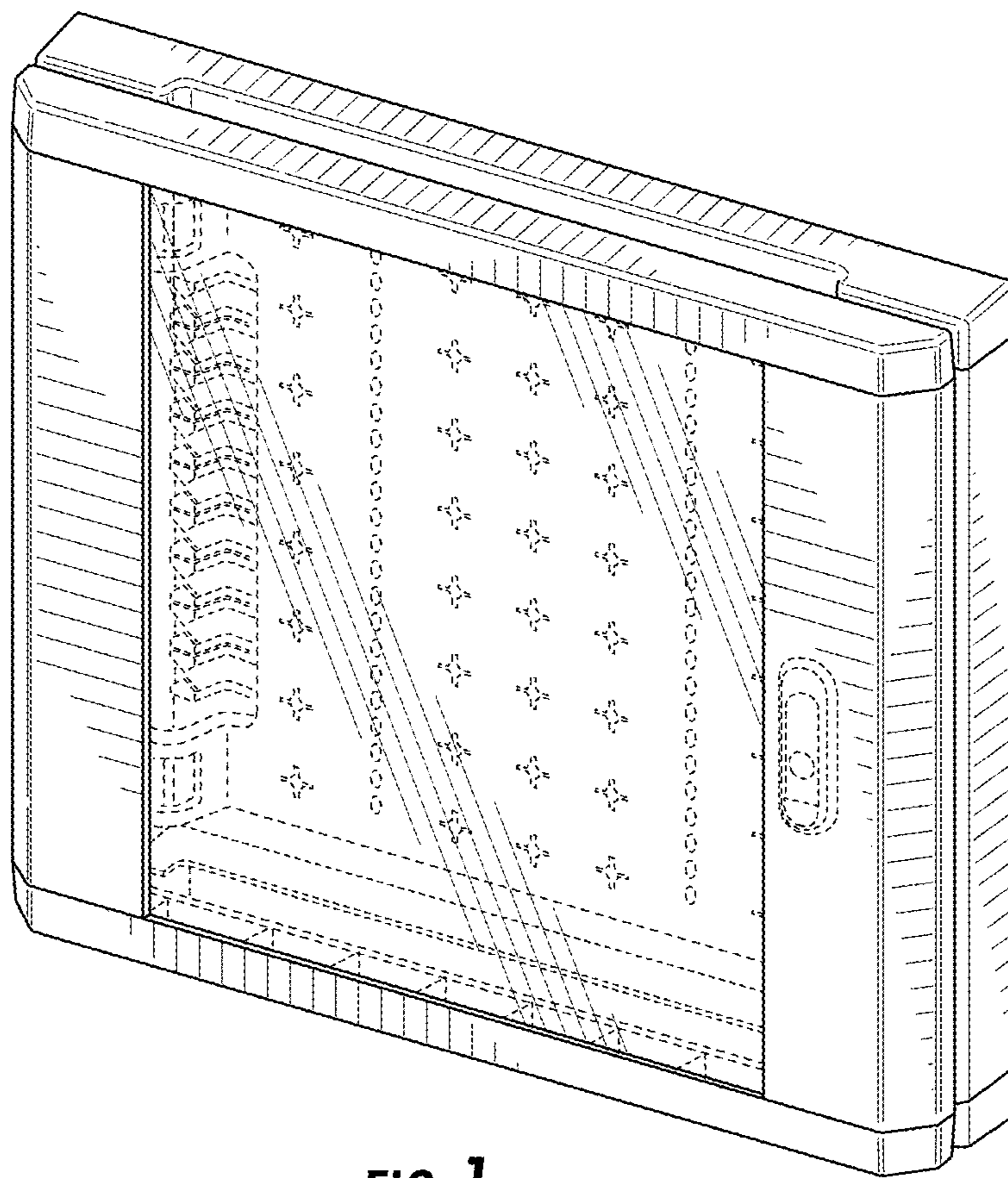

FIG. 1

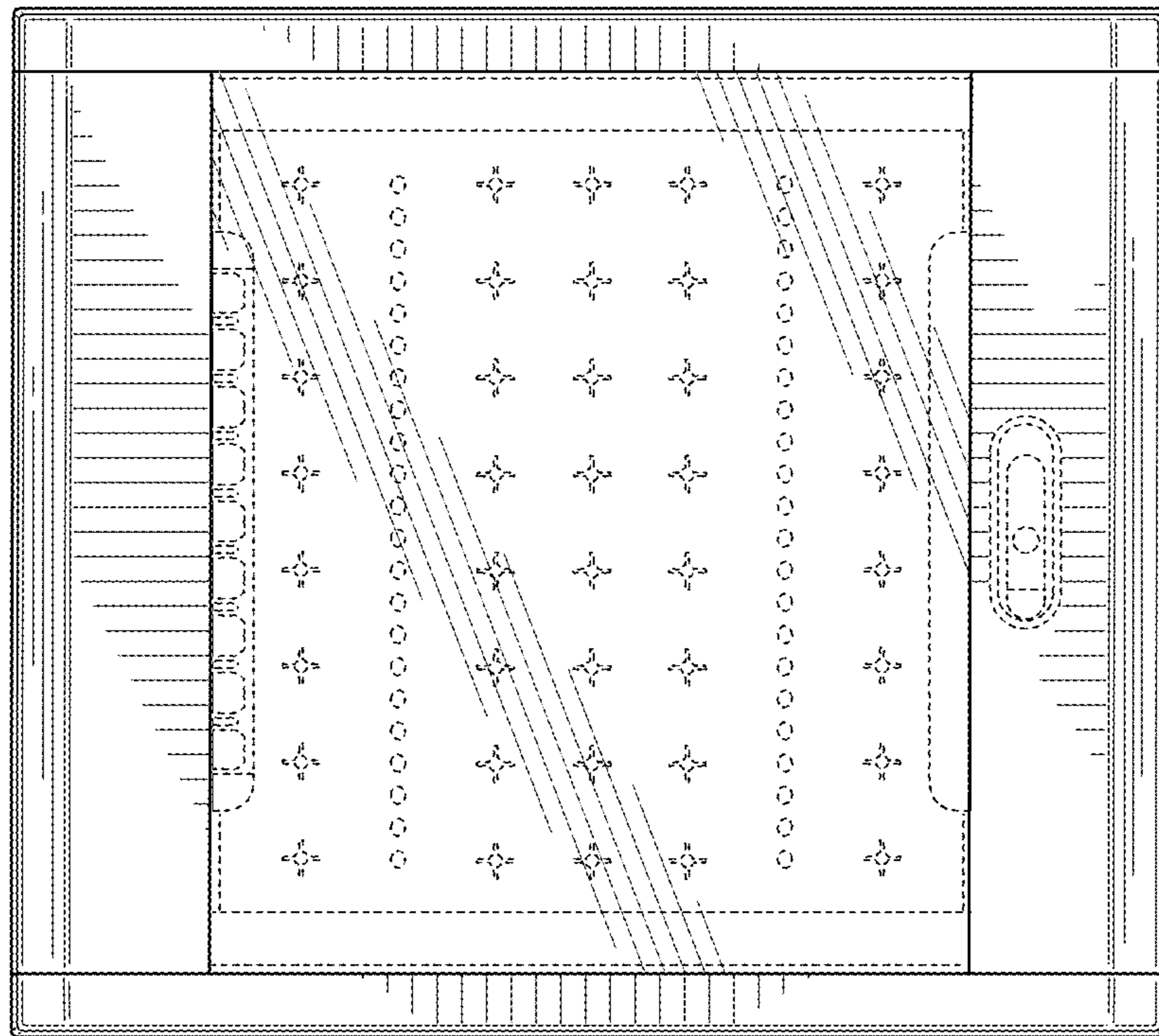

FIG. 2

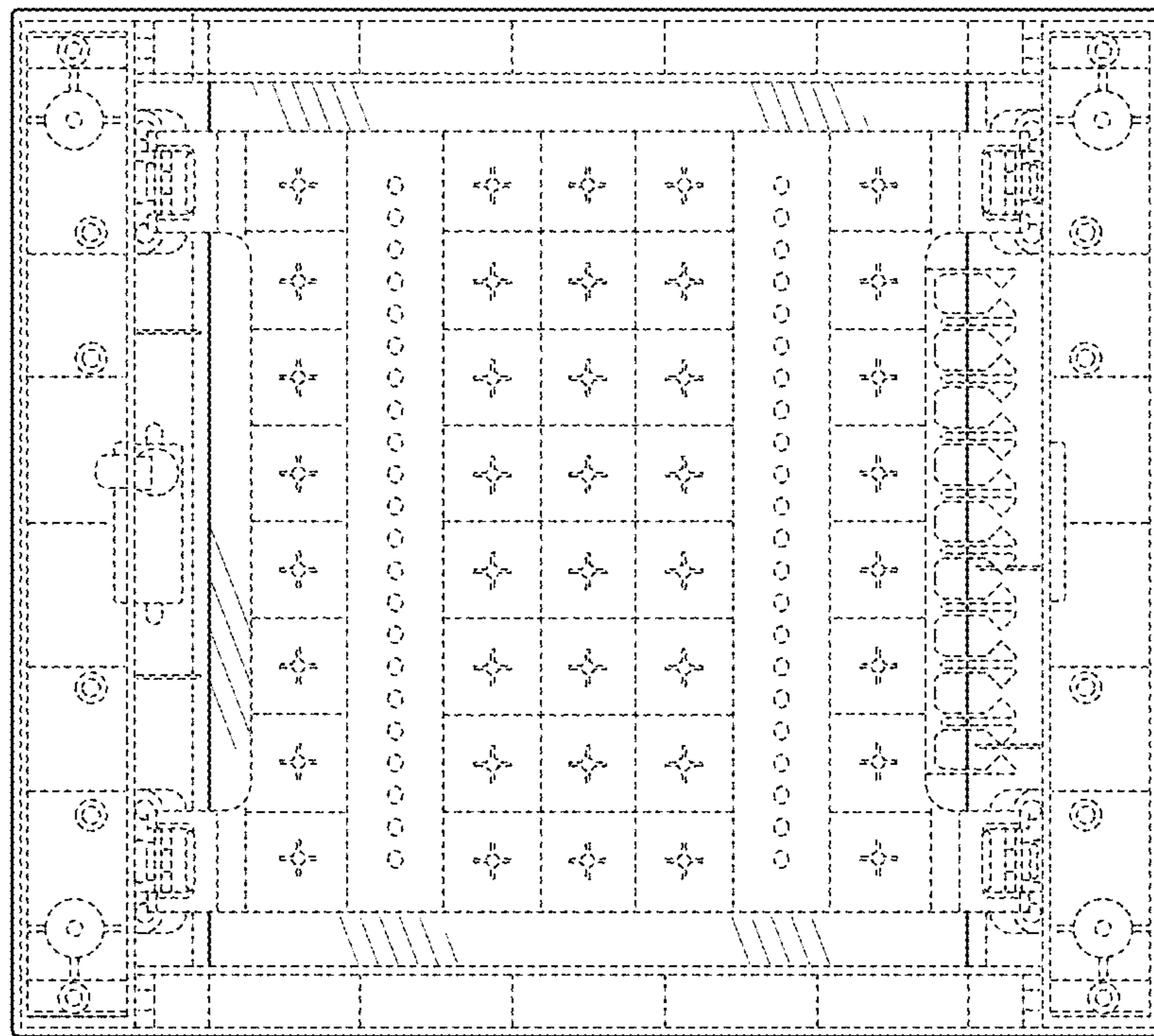

FIG. 3

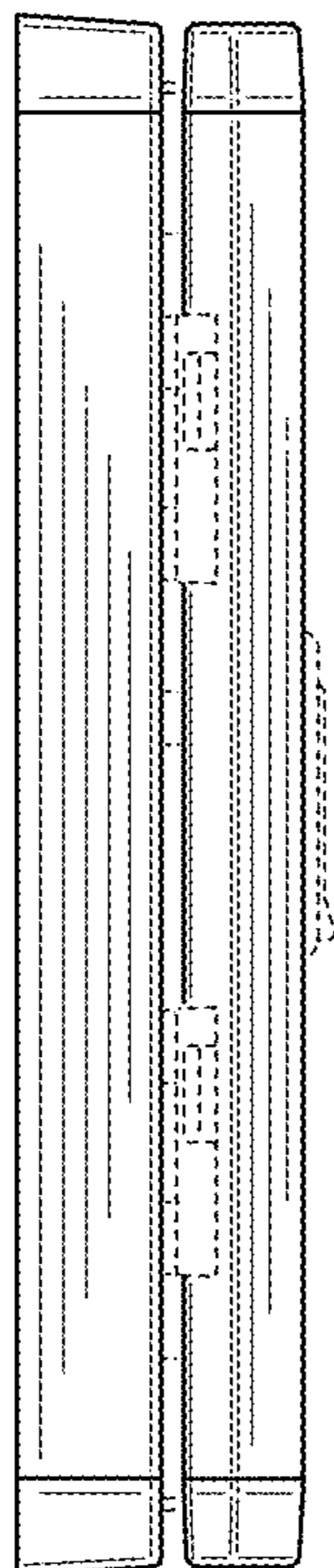

FIG. 4

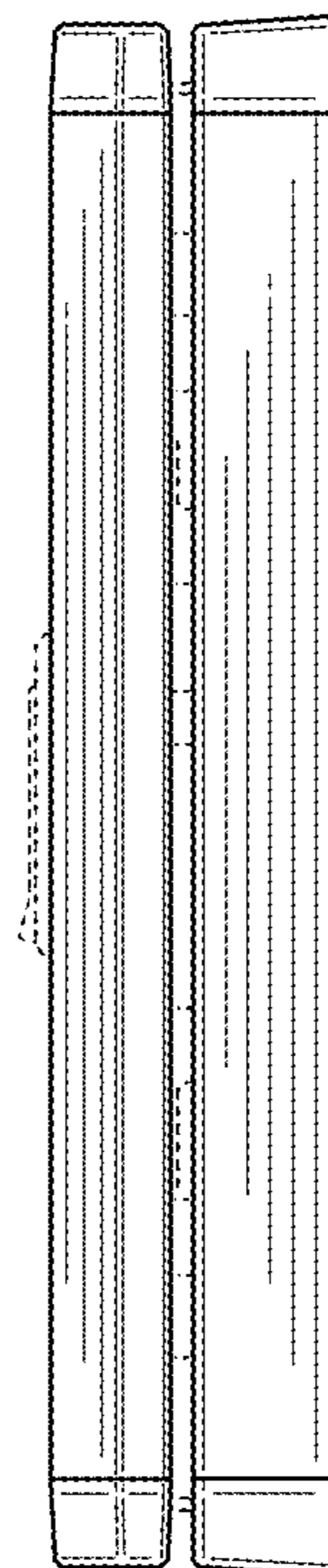

FIG. 5

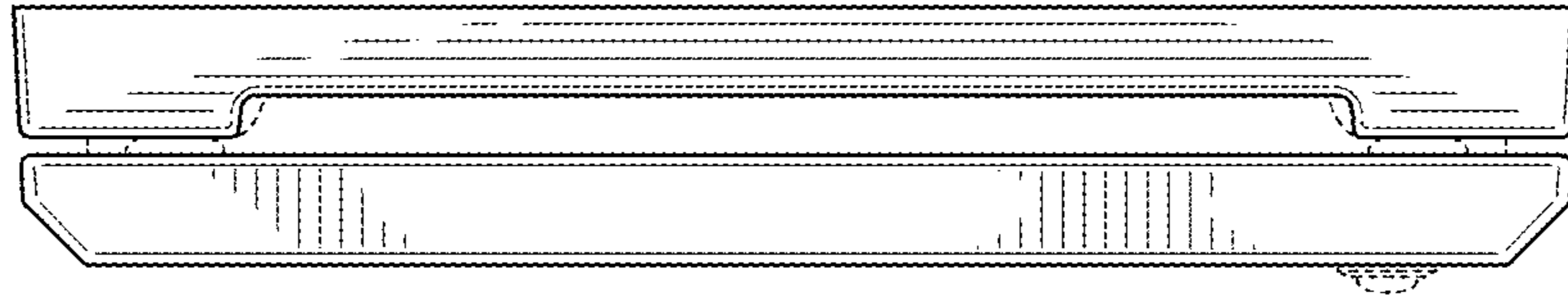

FIG. 6

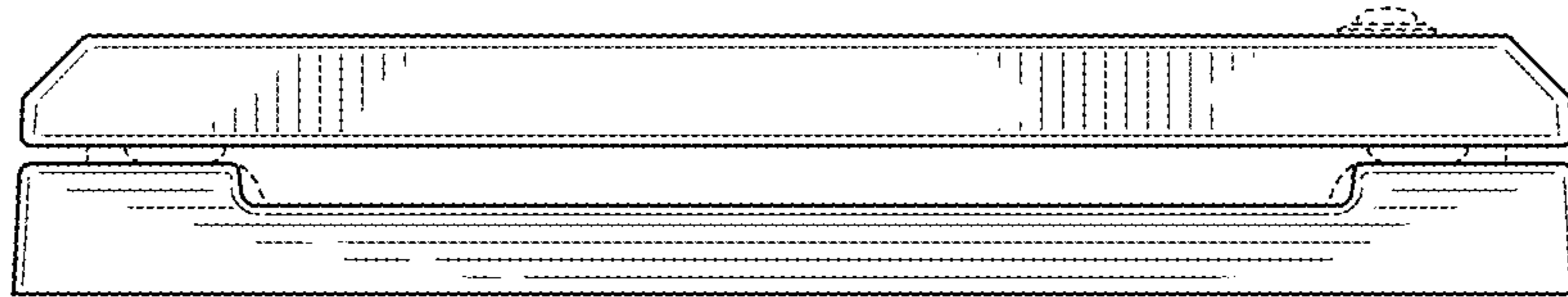

FIG. 7

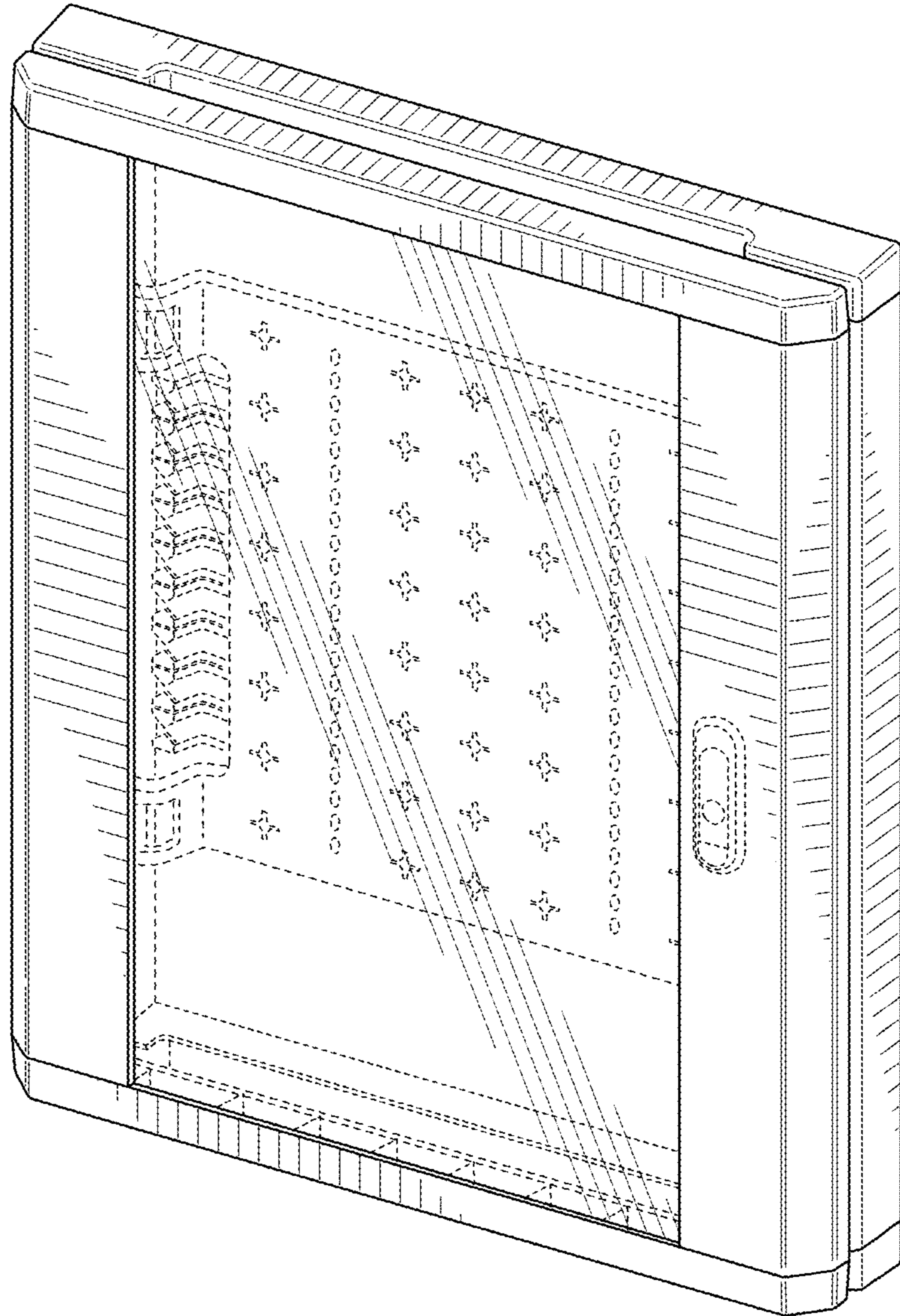

FIG. 8

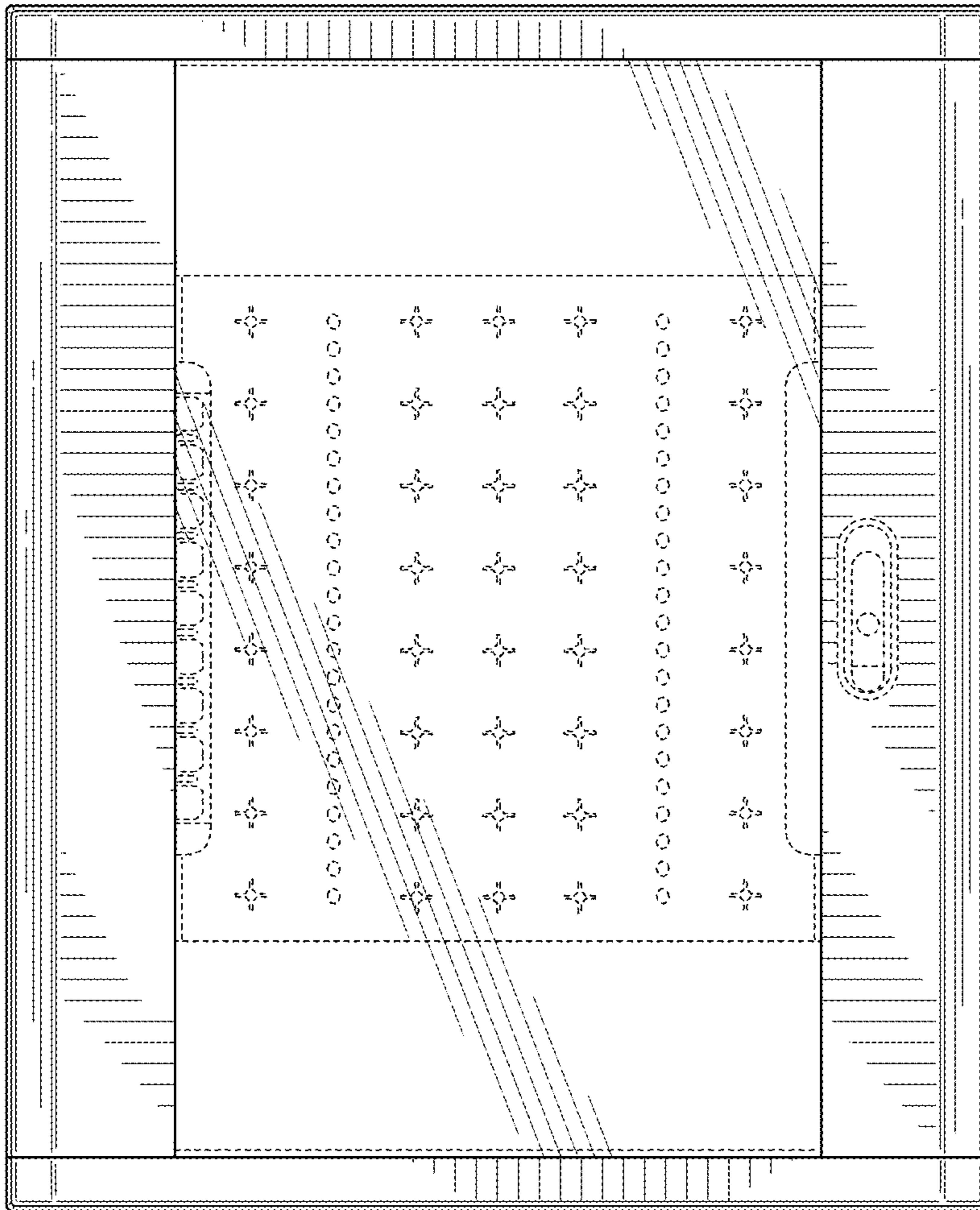

FIG. 9

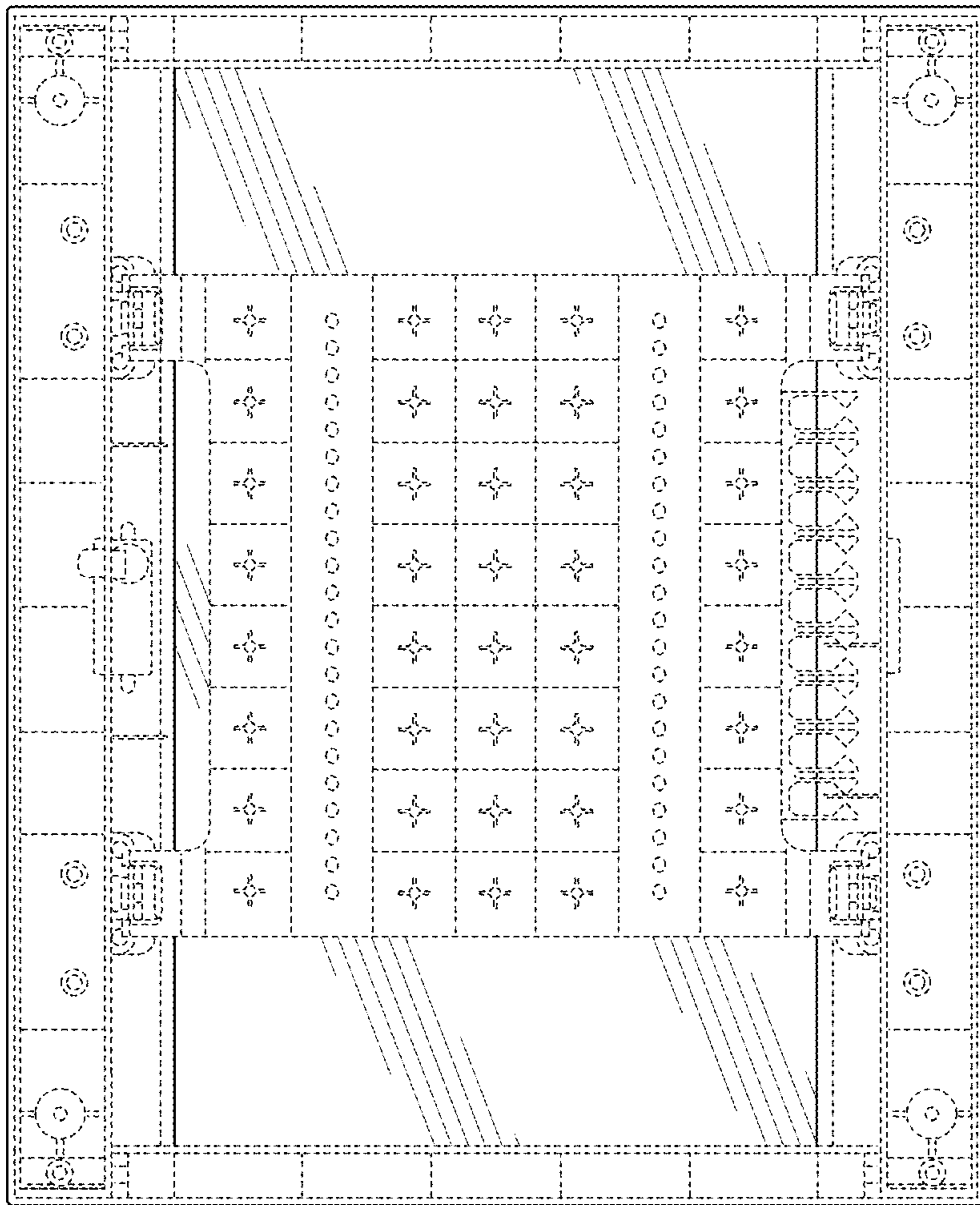

FIG. 10

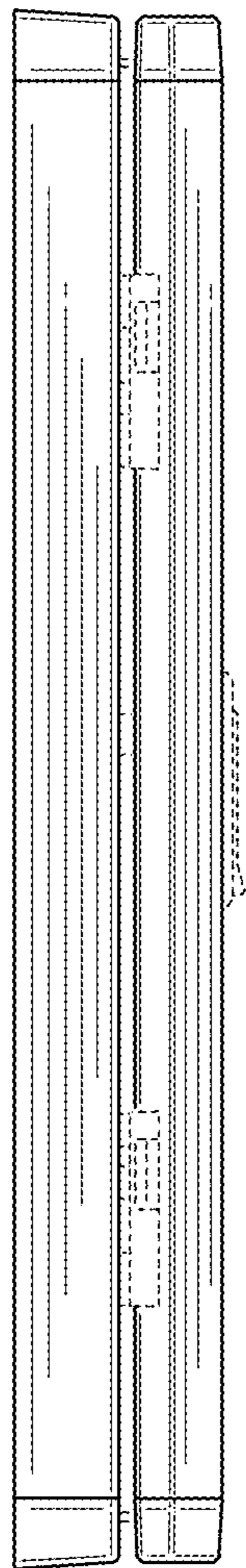

FIG. 11

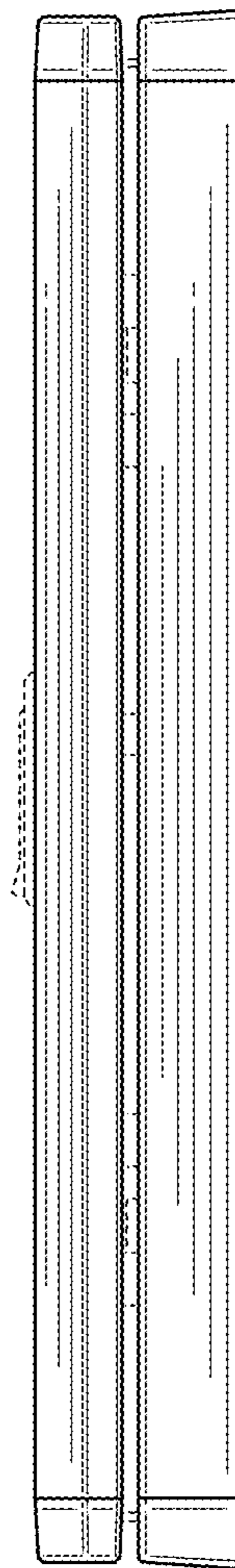

FIG. 12

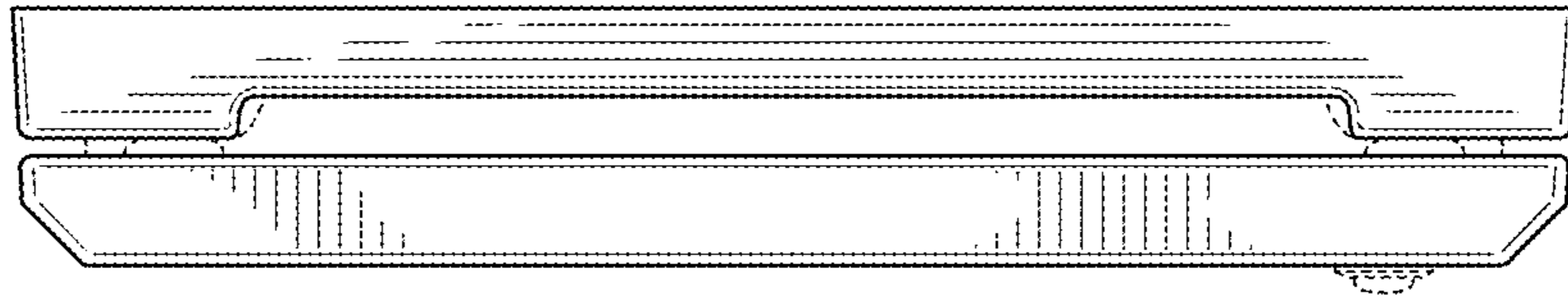

FIG. 13

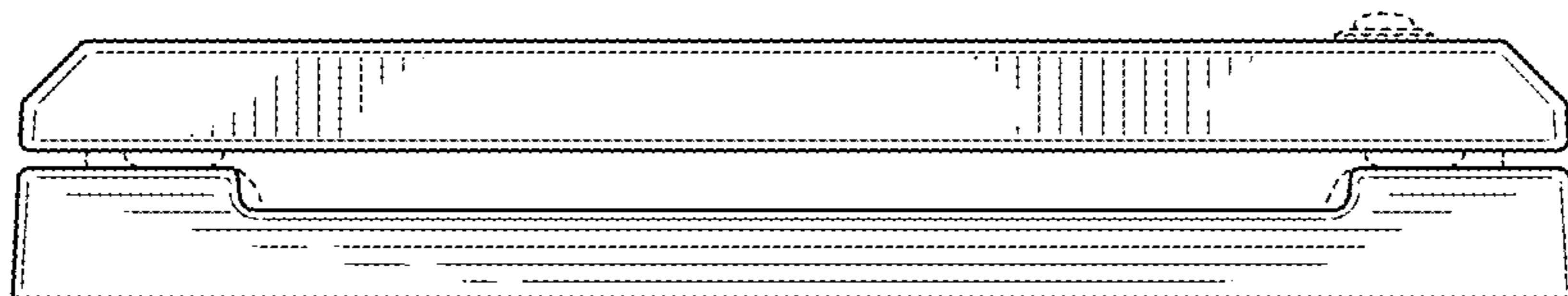

FIG. 14

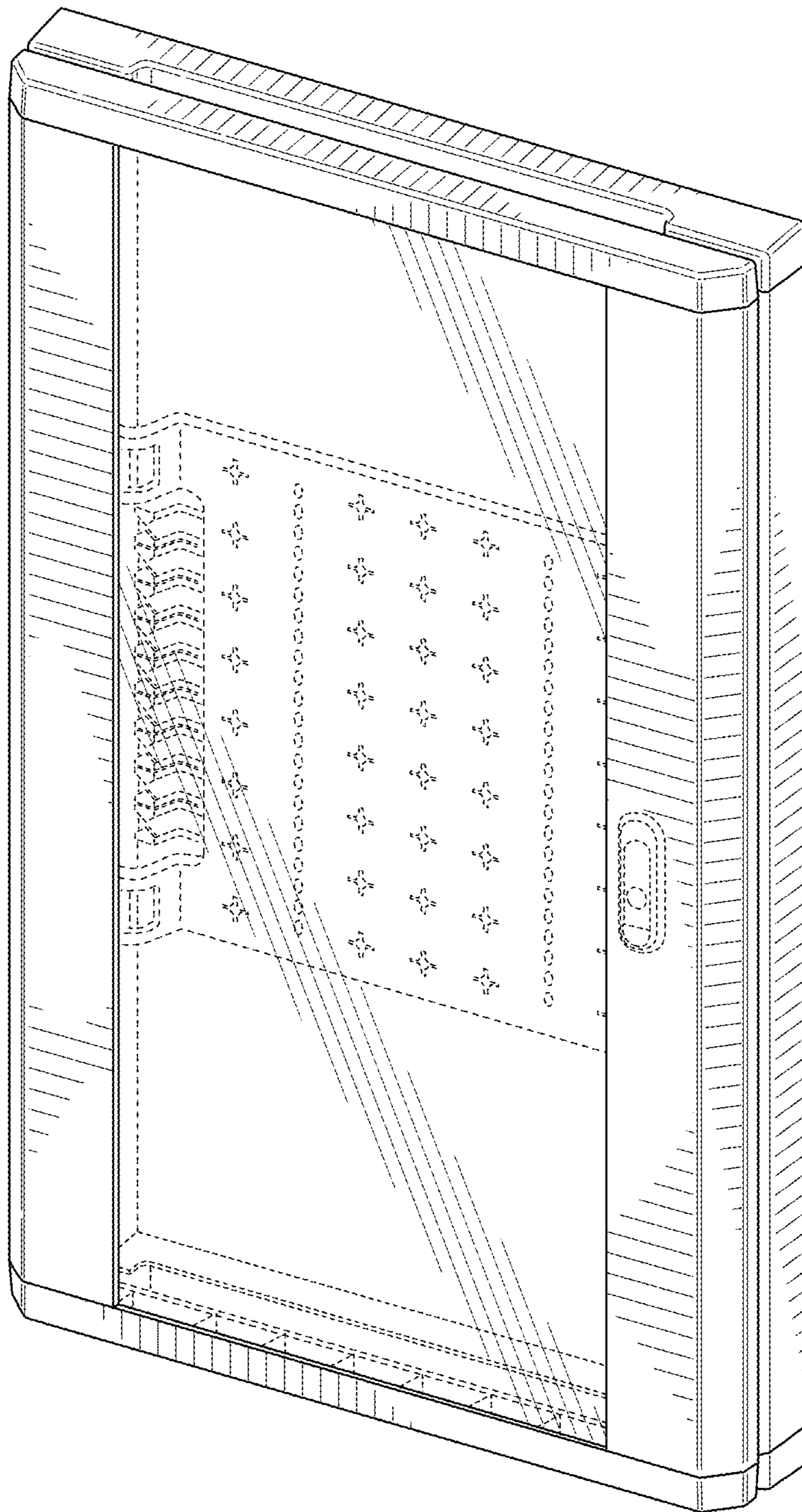

FIG. 15

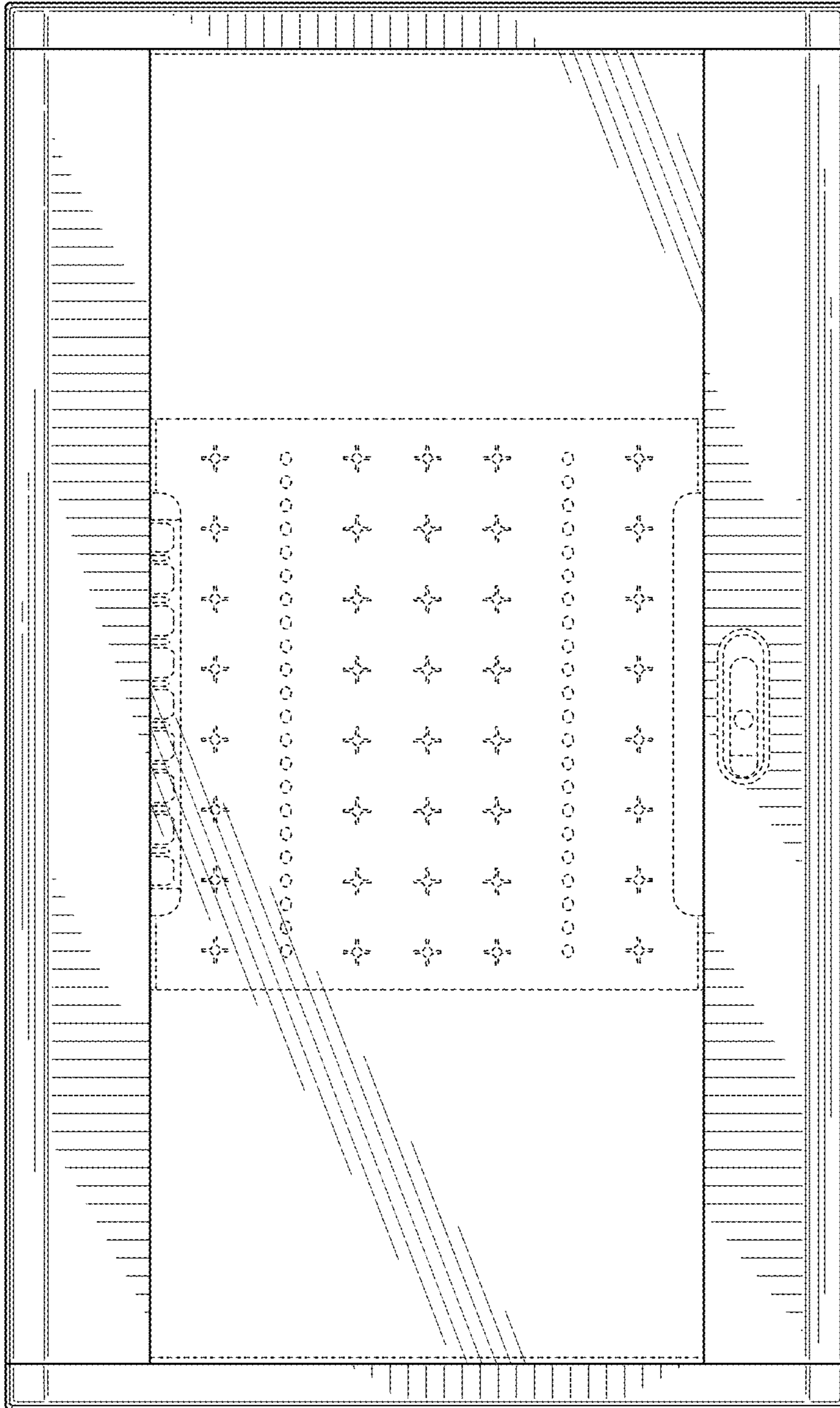

FIG. 16

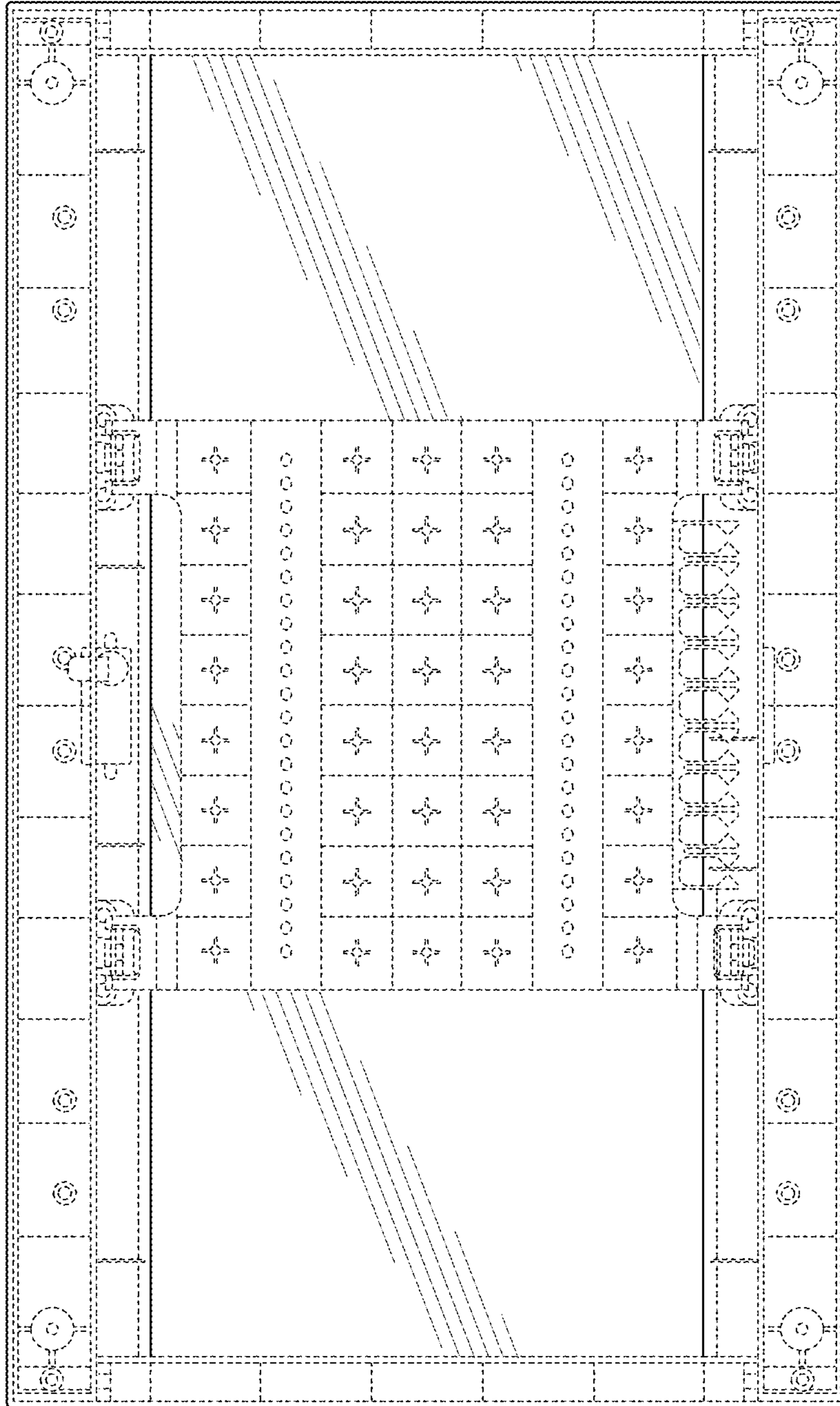

FIG. 17

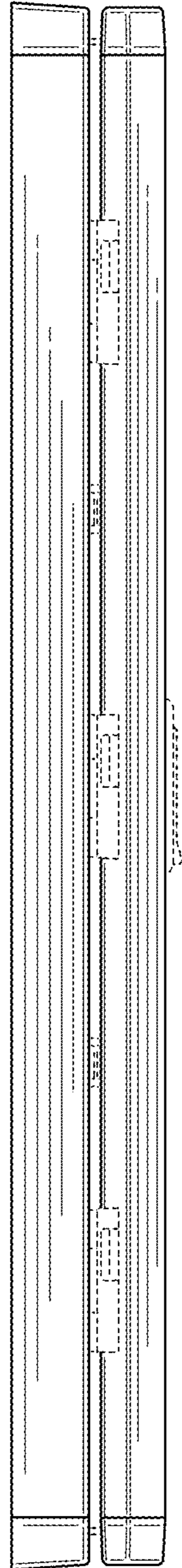

FIG. 18

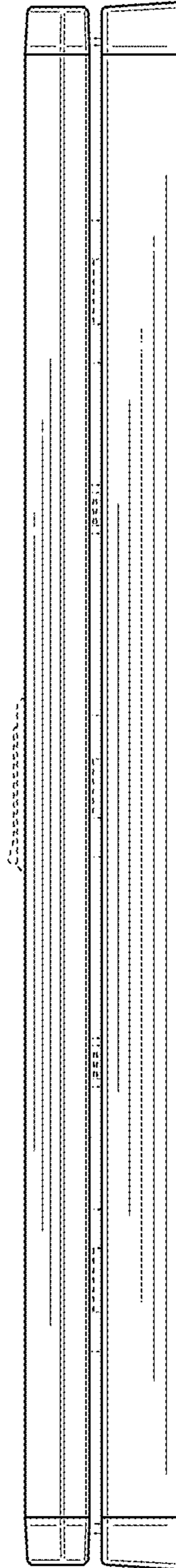

FIG. 19

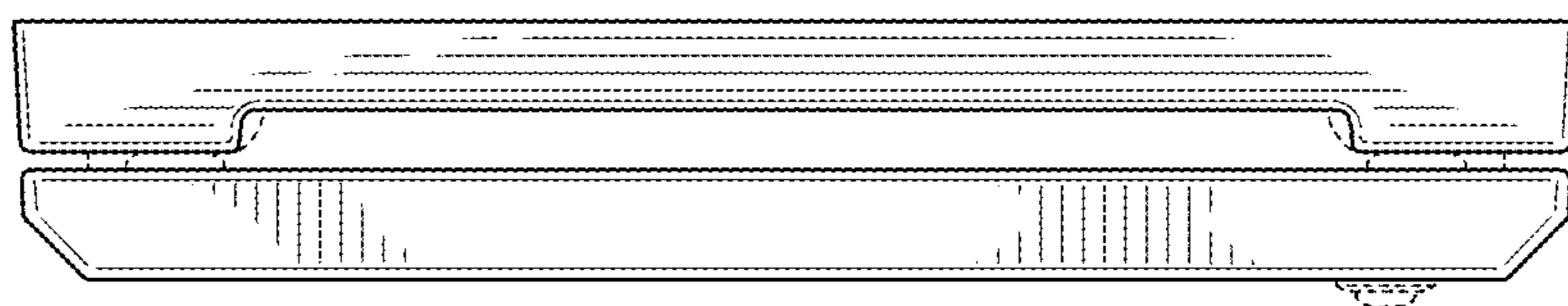

FIG. 20

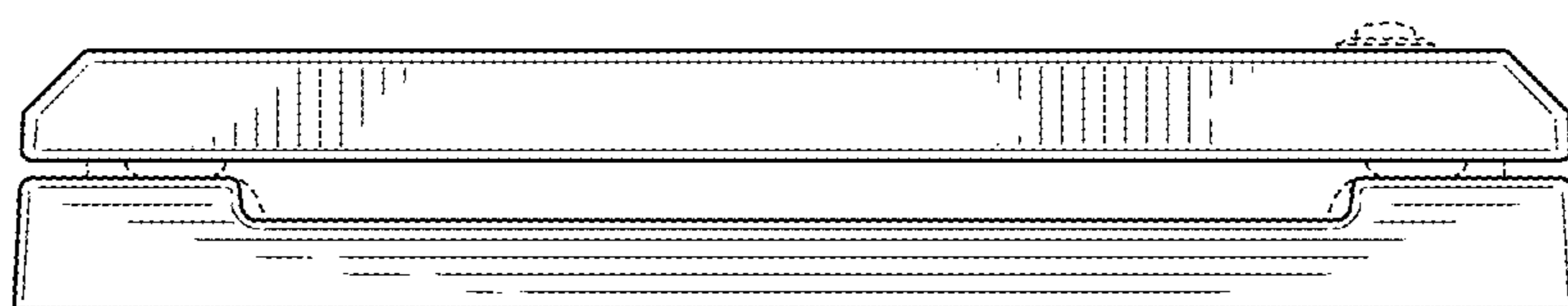

FIG. 21