



US00D795083S

(12) **United States Design Patent**
Safiullin

(10) **Patent No.:** **US D795,083 S**

(45) **Date of Patent:** **** Aug. 22, 2017**

- (54) **DUAL CHAMBER PACKAGING**
- (71) Applicant: **Sergei Safiullin**, Izhevsk (RU)
- (72) Inventor: **Sergei Safiullin**, Izhevsk (RU)
- (73) Assignee: **Sergei Safiullin**, Izhevsk (RU)
- (**) Term: **14 Years**
- (21) Appl. No.: **29/523,198**
- (22) Filed: **Apr. 7, 2015**
- (51) **LOC (10) Cl.** **09-03**
- (52) **U.S. Cl.**
USPC **D9/756**
- (58) **Field of Classification Search**
USPC D9/762, 757, 737, 761, 420-426, 432,
D9/418, 415, 501, 72, 739, 742, 753, 756,
D9/741, 414, 416; D7/611, 550.1, 605,
D7/701, 553.1, 553.2, 614; D3/313, 304,
D3/311, 314, 315, 294, 20, 201,
D3/203.1-203.3, 203.5, 203.6, 203.8, 205,
D3/206, 218, 269, 273, 274, 295;
D24/227; D28/64.1-64.7, 76-84;
206/139, 201-203, 427, 265, 504, 518,
206/519, 524.1, 557, 561, 564, 565, 703,
206/704, 705, 523, 586, 515, 581, 823,
206/216, 223, 532; 220/4.26, 4.21, 4.23,
220/836-839, 810, 244; 229/103.2,
229/120.02, 120.03, 123.1, 123.2, 123.3,
229/87.01, 87.06, 87.12-87.19, 92.7, 406;
426/119, 112, 298, 614; 273/153 R,
273/157 R
CPC B65D 5/5495; B65D 85/1072; B65D
5/5253; B65D 85/1063; B65D 5/0085;
(Continued)

437,042 A * 9/1890 Peck B65D 5/5253
206/256

(Continued)

OTHER PUBLICATIONS

“Left, Right, Thumbs”, available Apr. 9, 2012, [online], [site visited Nov. 29, 2016]. Available from internet, <URL: <https://mexicoandback.wordpress.com/2012/04/09/left-right-thumbs/>>.*

Primary Examiner — Cathron Brooks
Assistant Examiner — Teddy Falloway
(74) *Attorney, Agent, or Firm* — Eliezer IP

(57) **CLAIM**

The ornamental design for a dual chamber packaging, as shown and described.

DESCRIPTION

This application is related to co-filed application for design patent, entitled Dual Chamber Packaging having Ser. No. 29/523,192, invented by the same inventor and filed on even date herewith.

FIG. 1 is a perspective view of a dual chamber packaging showing my new design, with end flaps shown in an open position;

FIG. 2 is a perspective view of thereof, with end flaps shown in a closed position;

FIG. 3 is a right side view thereof;

FIG. 4 is a left side view thereof;

FIG. 5 is a top view thereof; and

FIG. 6 is a bottom view thereof.

FIG. 7 is a front view thereof

FIG. 8 is a back view thereof; and,

FIG. 9 is a perspective view of the design in FIG. 1, but with the compartments shown in an unfolded configuration.

The broken lines illustrate portions of the dual chamber packaging that do not form a part of the claimed design.

(56) **References Cited**

U.S. PATENT DOCUMENTS

276,171 A * 4/1883 Fraser B65D 5/5253
206/256

1 Claim, 4 Drawing Sheets

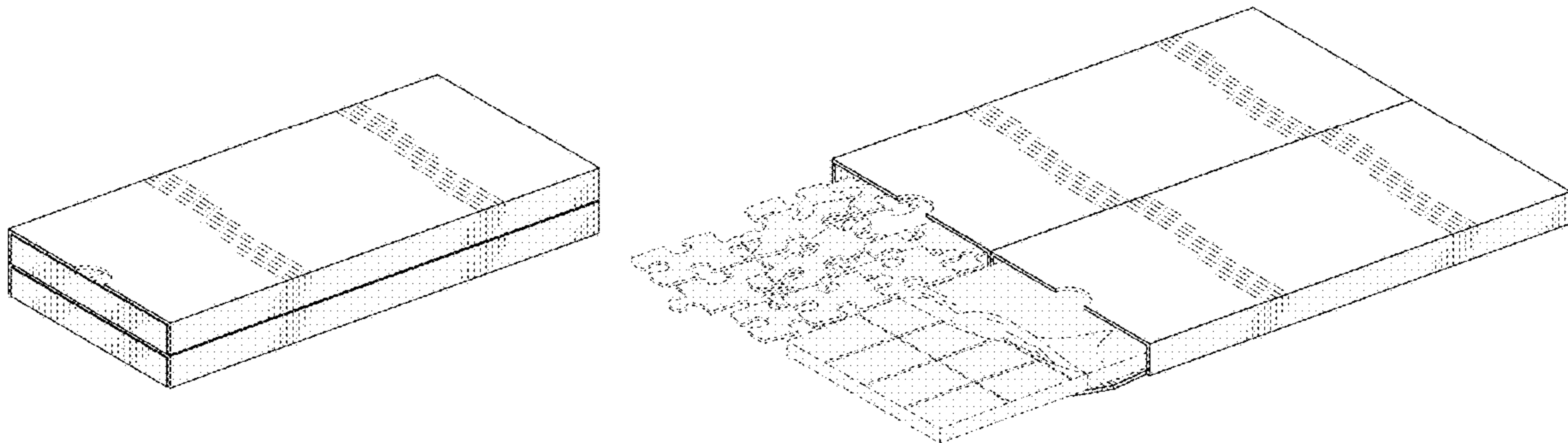

(58) **Field of Classification Search**
 CPC B65D 21/0204; B65D 5/427; B65D
 21/0201; B65D 5/009; B65D 77/006;
 B65D 85/324; B65D 85/32; B65D 71/70;
 B65D 85/322
 See application file for complete search history.

(56) **References Cited**

U.S. PATENT DOCUMENTS

1,046,337 A * 12/1912 Schoettle B65D 5/5253
 229/120.012
 1,863,190 A * 6/1932 Coulapides B65D 5/5495
 206/256
 1,987,496 A * 1/1935 Springborn A63F 9/1044
 273/157 R
 2,046,484 A * 7/1936 Ringler B65D 5/5495
 206/256
 2,162,094 A * 6/1939 Mahone B65D 5/0085
 206/472
 3,357,543 A * 12/1967 Taggart B65D 5/5253
 206/747
 4,294,353 A * 10/1981 Focke B65D 85/1063
 206/273
 4,377,237 A * 3/1983 Pawlowski B65D 5/5495
 229/120.011
 4,928,817 A * 5/1990 Focke B65D 71/0085
 206/242
 4,932,534 A * 6/1990 Focke B65D 85/1072
 206/273
 5,044,494 A * 9/1991 Tamura A61B 42/40
 206/299
 D328,390 S * 8/1992 MacDonald D3/270
 5,148,916 A * 9/1992 Tillyer, Sr. A45D 27/24
 206/228
 5,174,443 A * 12/1992 Chance B65D 5/5495
 206/256
 5,178,268 A * 1/1993 Talley B65D 5/5495
 206/256
 5,180,056 A * 1/1993 Adams B65D 5/5495
 206/256
 5,261,533 A * 11/1993 Adams B65D 85/1072
 206/261

5,344,008 A * 9/1994 DeBlasio B65D 85/1072
 206/256
 5,871,142 A * 2/1999 Josephson A45C 3/02
 229/120.09
 D458,128 S * 6/2002 Gray D9/432
 D521,862 S * 5/2006 Siethoff D9/432
 D537,561 S * 2/2007 Counts D27/189
 D591,899 S * 5/2009 Bray D27/189
 D591,902 S * 5/2009 Bray D27/189
 D594,742 S * 6/2009 Meier D9/432
 D639,563 S * 6/2011 Chilewich D3/313
 8,074,429 B2 * 12/2011 Hodges B65B 19/12
 206/268
 8,141,707 B2 * 3/2012 Robbins B65D 5/545
 206/447
 8,413,805 B2 * 4/2013 Bray B65D 5/009
 206/257
 D699,561 S * 2/2014 Buchanan D9/416
 D702,116 S * 4/2014 Buchanan D9/416
 8,763,890 B2 * 7/2014 Clark B32B 3/085
 206/813
 8,893,955 B2 * 11/2014 Clark B65D 5/0085
 229/120.09
 8,950,659 B2 * 2/2015 Markovic B65D 5/5445
 206/257
 D726,819 S * 4/2015 Botha D19/75
 D748,978 S * 2/2016 Glass D9/432
 D758,851 S * 6/2016 Binder D9/432
 D762,487 S * 8/2016 Safiullin D9/756
 D766,108 S * 9/2016 Brown D9/721
 9,469,455 B2 * 10/2016 Clough B65D 75/56
 D772,559 S * 11/2016 Binder D3/203.6
 2005/0150788 A1 * 7/2005 Feusner B65D 85/18
 206/278
 2007/0063005 A1 * 3/2007 Gomes B65D 5/18
 229/120.09
 2010/0187145 A1 * 7/2010 Mezzini B65D 5/50
 206/460
 2010/0206757 A1 * 8/2010 Kesselman A24D 1/02
 206/494
 2012/0241512 A1 * 9/2012 Markovic B65D 5/5445
 229/120.02

* cited by examiner

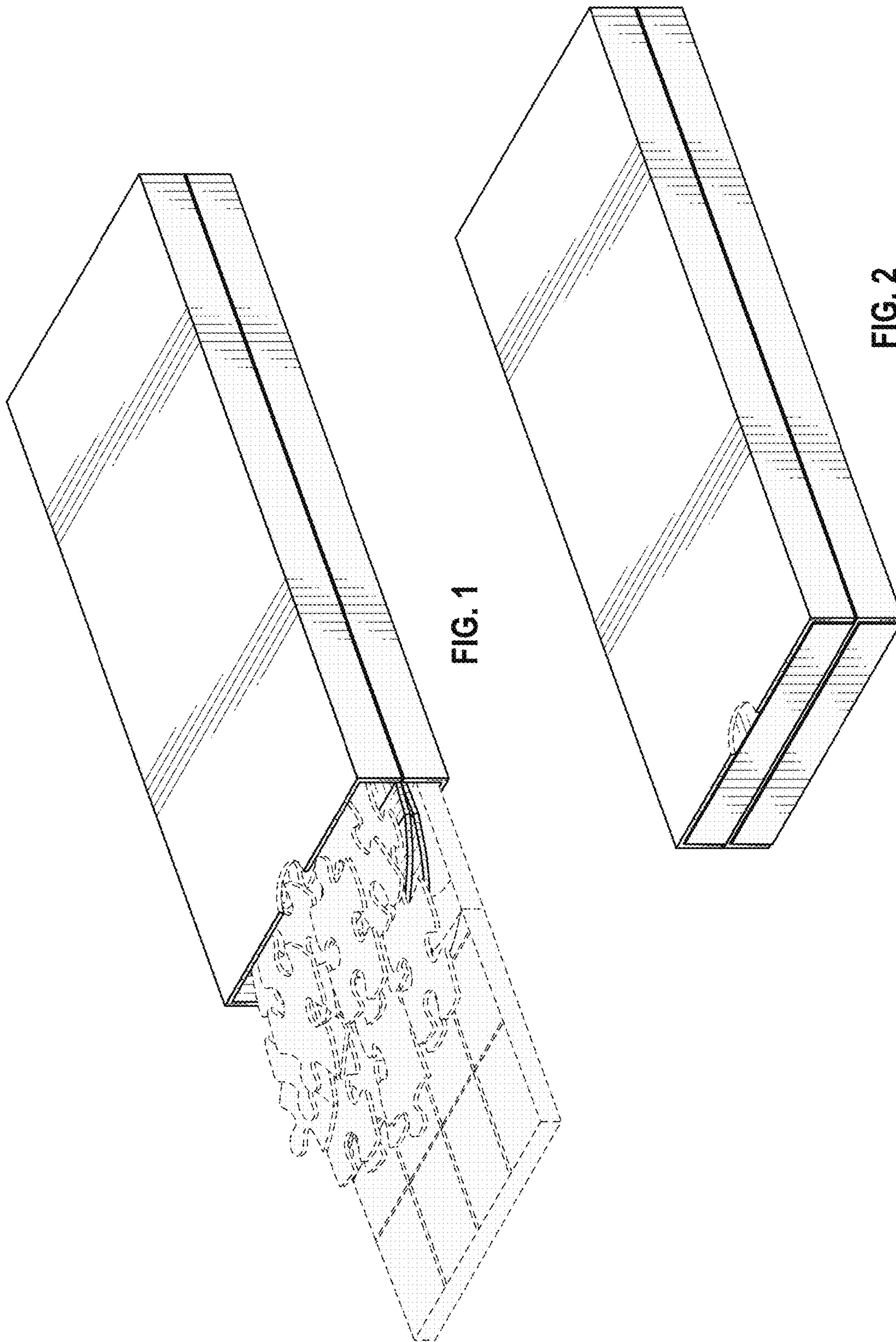

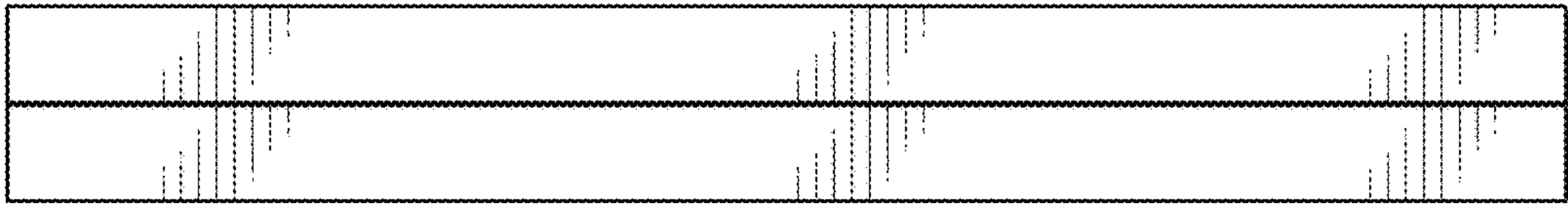

FIG. 3

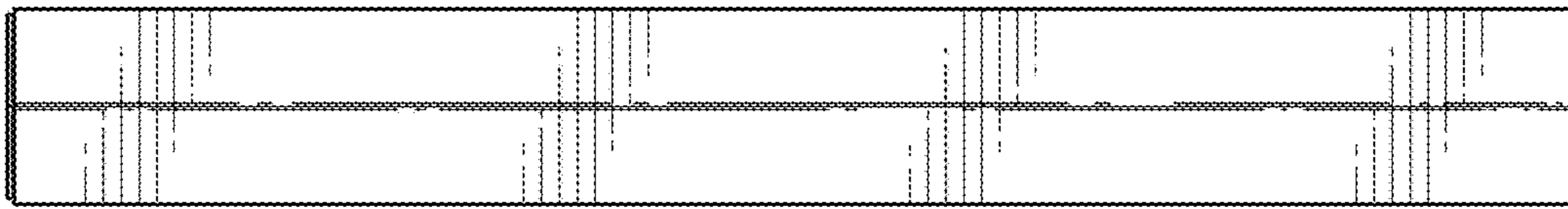

FIG. 4

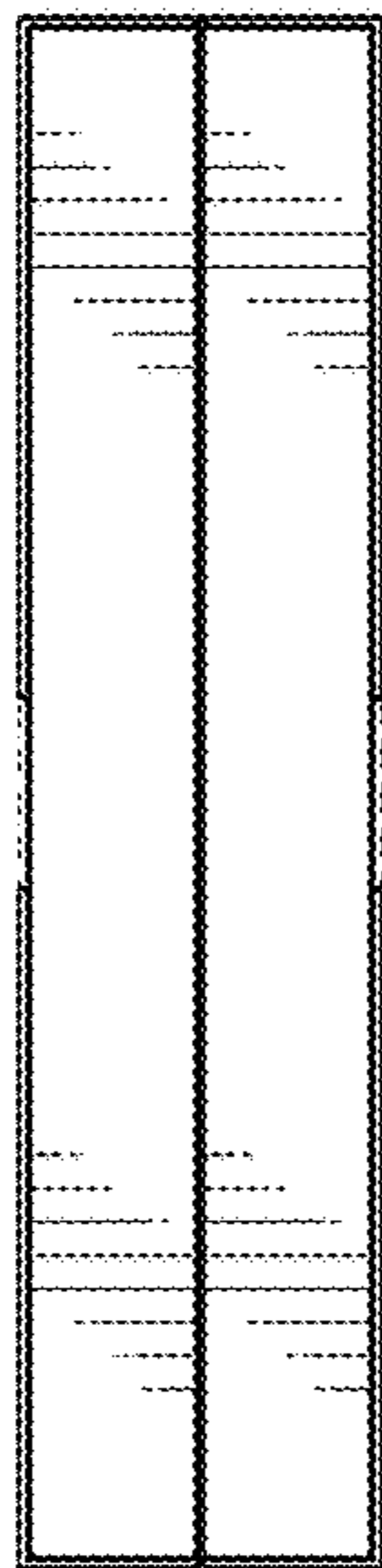

FIG. 5

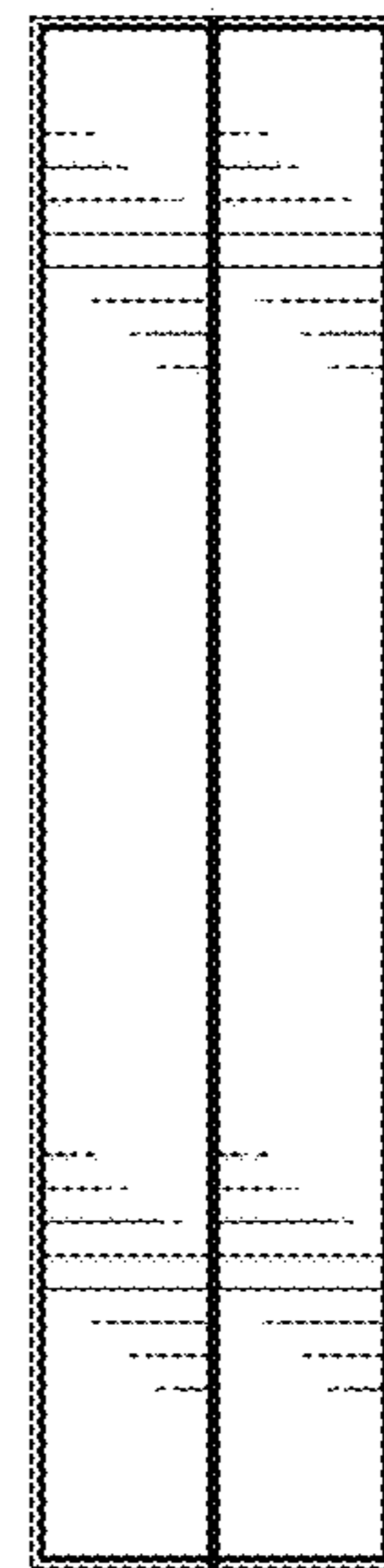

FIG. 6

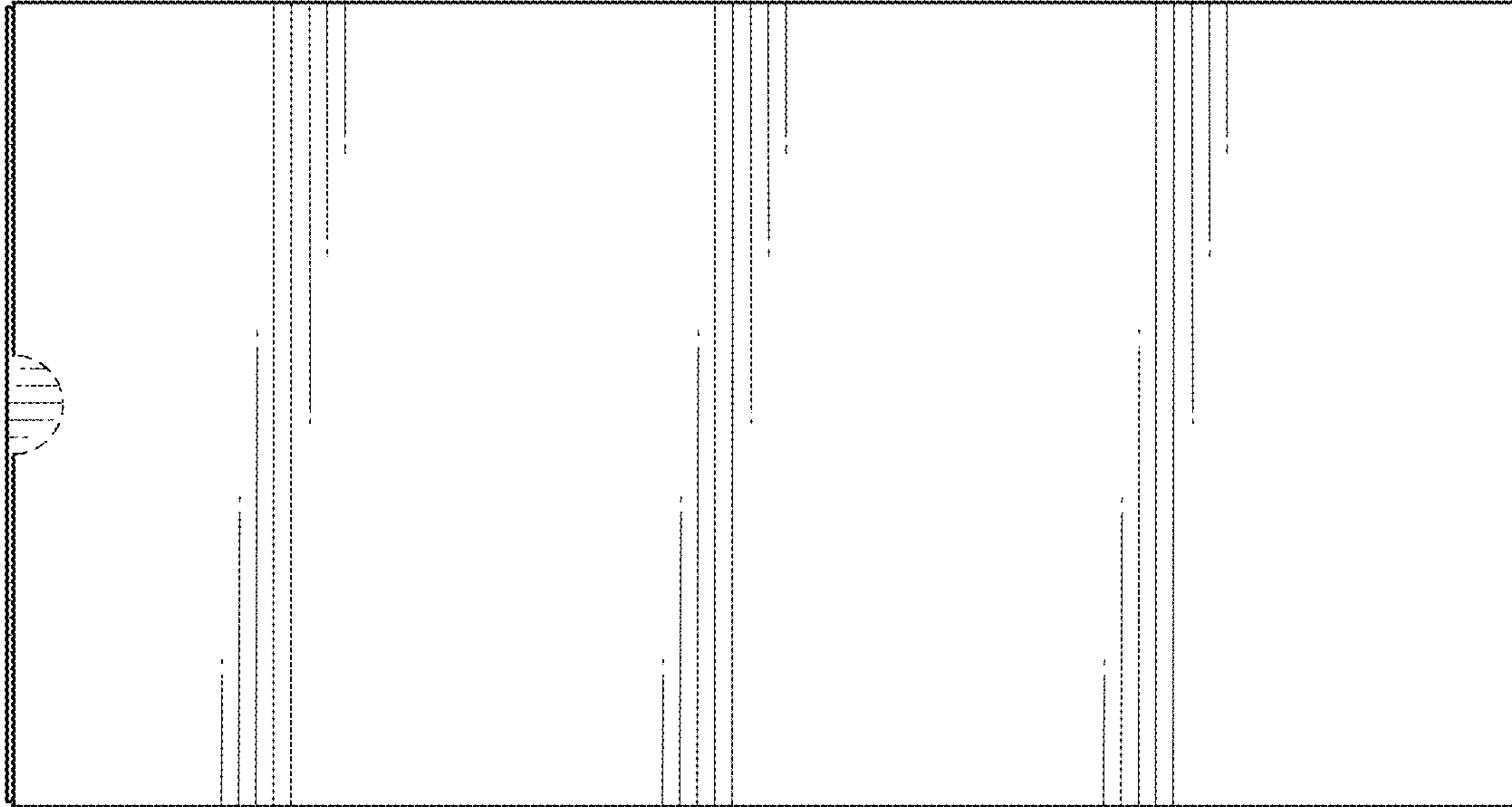

FIG. 7

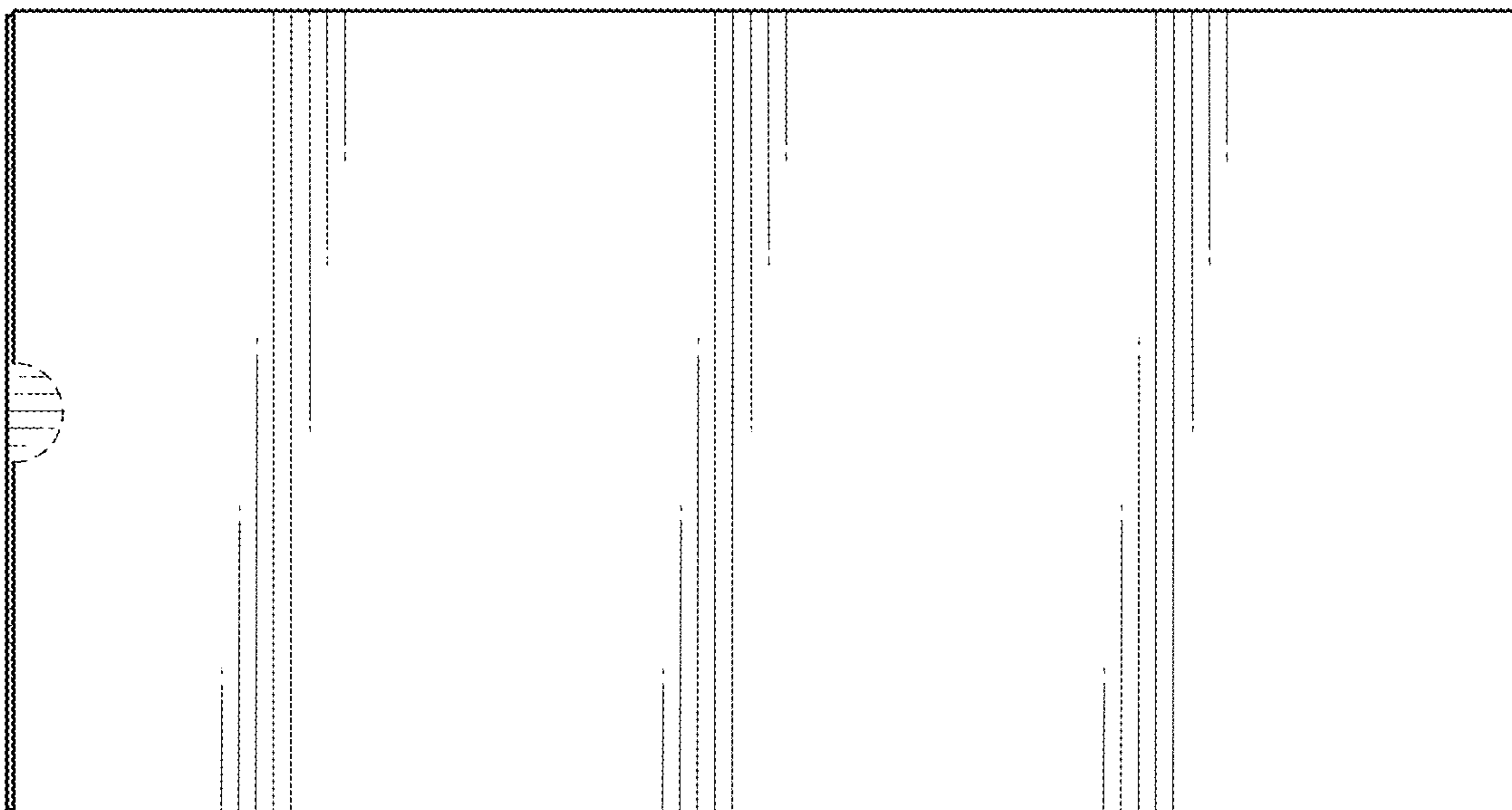

FIG. 8

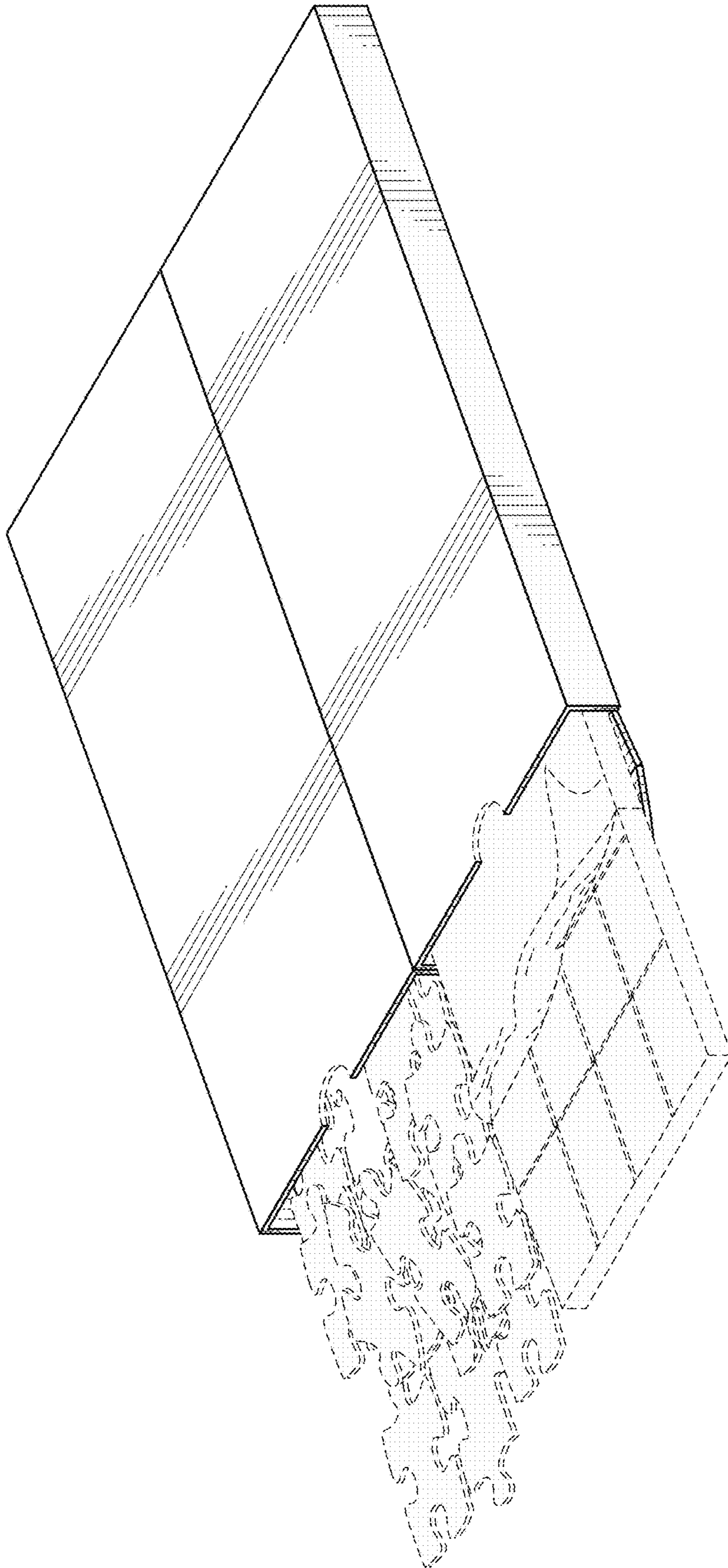

FIG. 9