



US00D795056S

(12) **United States Design Patent** (10) **Patent No.:** **US D795,056 S**  
**Zeitlin et al.** (45) **Date of Patent:** **\*\* \*Aug. 22, 2017**

(54) **CLAMSHELL CONTAINER**

(71) Applicants: **Gavriel Zeitlin**, Beit Shemesh (IL);  
**David Rubli**, Revava (IL); **Uzi Malimovka**, Givat Shmuel (IL)

(72) Inventors: **Gavriel Zeitlin**, Beit Shemesh (IL);  
**David Rubli**, Revava (IL); **Uzi Malimovka**, Givat Shmuel (IL)

(73) Assignee: **ALTRIA CLIENT SERVICES LLC**,  
Richmond, VA (US)

(\*) Notice: This patent is subject to a terminal disclaimer.

(\*\*) Term: **15 Years**

(21) Appl. No.: **29/548,425**

(22) Filed: **Dec. 14, 2015**

**Related U.S. Application Data**

(63) Continuation-in-part of application No. 29/542,286,  
filed on Oct. 13, 2015.

(51) **LOC (10) Cl.** ..... **09-03**

(52) **U.S. Cl.**  
USPC ..... **D9/420**; D3/294

(58) **Field of Classification Search**  
USPC ..... D3/202, 212, 318, 294; D7/602;  
D9/414, 420, 423, 425, 426, 430-434,  
D9/455-457, 499

(Continued)

(56) **References Cited**

**U.S. PATENT DOCUMENTS**

D48,897 S \* 4/1916 Hubbard ..... D9/423  
D182,654 S \* 4/1958 Glaberson ..... D9/420

(Continued)

**OTHER PUBLICATIONS**

E-cigarette reviewed. Green Smoke Review. Jan. 2, 2016 [earliest online date], [site visited Nov. 15, 2016]. Available from Internet, <URL:http://ecigarettereviwed.com/green-smoke-reviews>.\*

(Continued)

*Primary Examiner* — Robert M Spear  
*Assistant Examiner* — Darcey E Heflin

(74) *Attorney, Agent, or Firm* — Harness, Dickey & Pierce, PLC

(57) **CLAIM**

The ornamental design for a clamshell container, as shown and described.

**DESCRIPTION**

FIG. 1 illustrates a front left perspective view of a clamshell container;

FIG. 2 illustrates a front right perspective view of the clamshell container of FIG. 1;

FIG. 3 illustrates a front elevation view of the clamshell container of FIG. 1;

FIG. 4 illustrates a rear elevation view of the clamshell container of FIG. 1;

FIG. 5 illustrates a left side elevation view of the clamshell container of FIG. 1;

FIG. 6 illustrates a right side elevation view of the clamshell container of FIG. 1;

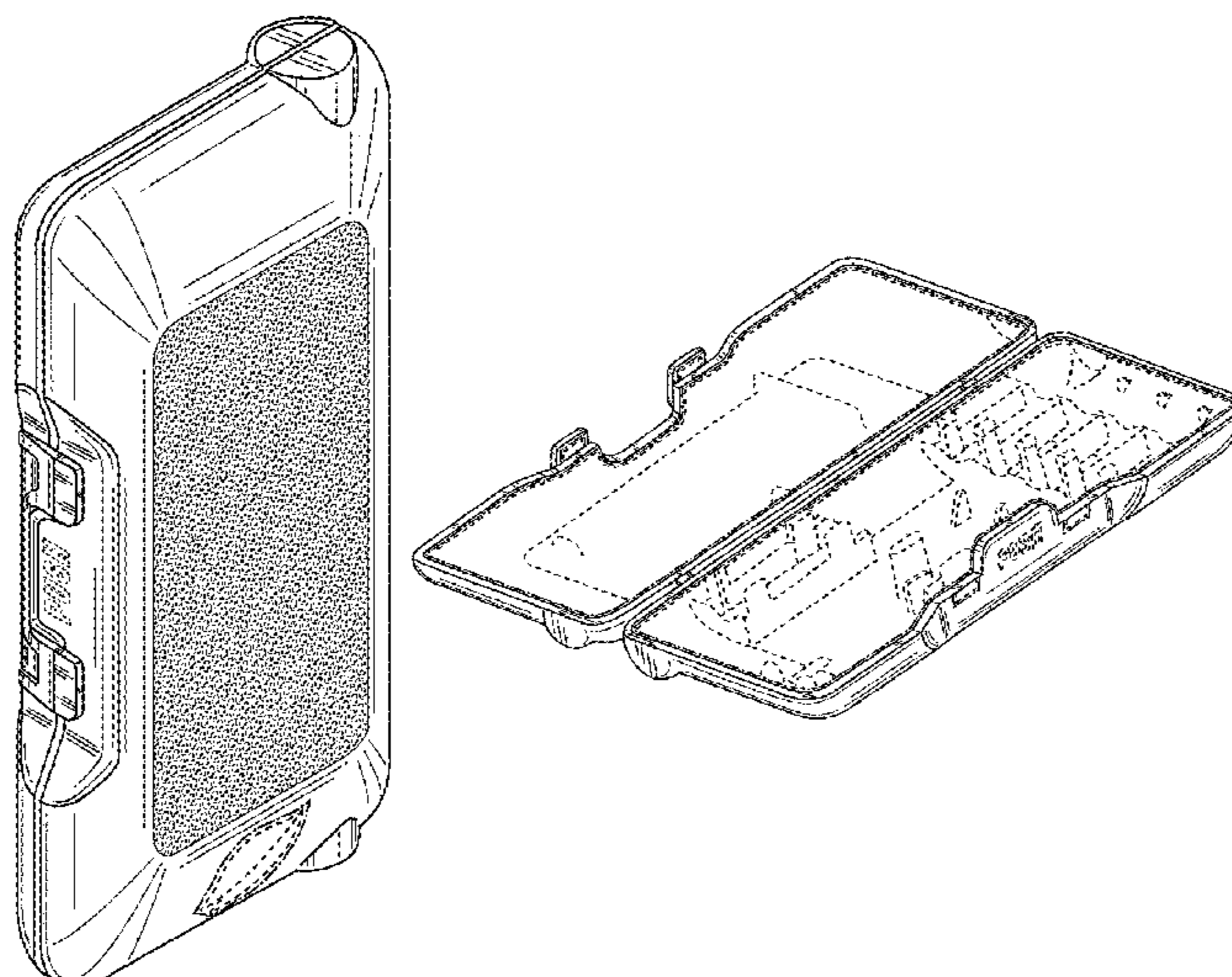
FIG. 7 illustrates a top plan view of the clamshell container of FIG. 1;

FIG. 8 illustrates a bottom plan view of the clamshell container of FIG. 1; and,

FIG. 9 illustrates a perspective view of an alternate configuration of the clamshell container of FIG. 1.

It In the drawings, the broken line showing portions of the clamshell container depicts environment and forms no part of the claim. Alternating dashed-dot lines are boundary lines, the area within which is unclaimed and represented by dashed lines.

**1 Claim, 9 Drawing Sheets**



(58) **Field of Classification Search**

CPC ..... B65D 77/00  
See application file for complete search history.

(56) **References Cited**

U.S. PATENT DOCUMENTS

D245,762	S	*	9/1977	Takacs	.....	D9/420
D278,412	S	*	4/1985	Yeung	.....	D9/420
D337,049	S	*	7/1993	Morgan	.....	D9/420
D386,308	S	*	11/1997	Chen	.....	D3/276
D458,127	S	*	6/2002	de Groote	.....	D3/294
D482,609	S	*	11/2003	Weinstock	.....	D9/414
D592,399	S	*	5/2009	Sage	.....	D3/295
D623,050	S	*	9/2010	Giraud	.....	D9/420
D672,952	S	*	12/2012	Yang	.....	D3/247
D675,434	S	*	2/2013	Vernall	.....	D3/294
D735,476	S	*	8/2015	Duvigneau	.....	D3/294
D746,671	S	*	1/2016	Fohner	.....	D9/414
D758,805	S	*	6/2016	Myoung	.....	D7/629

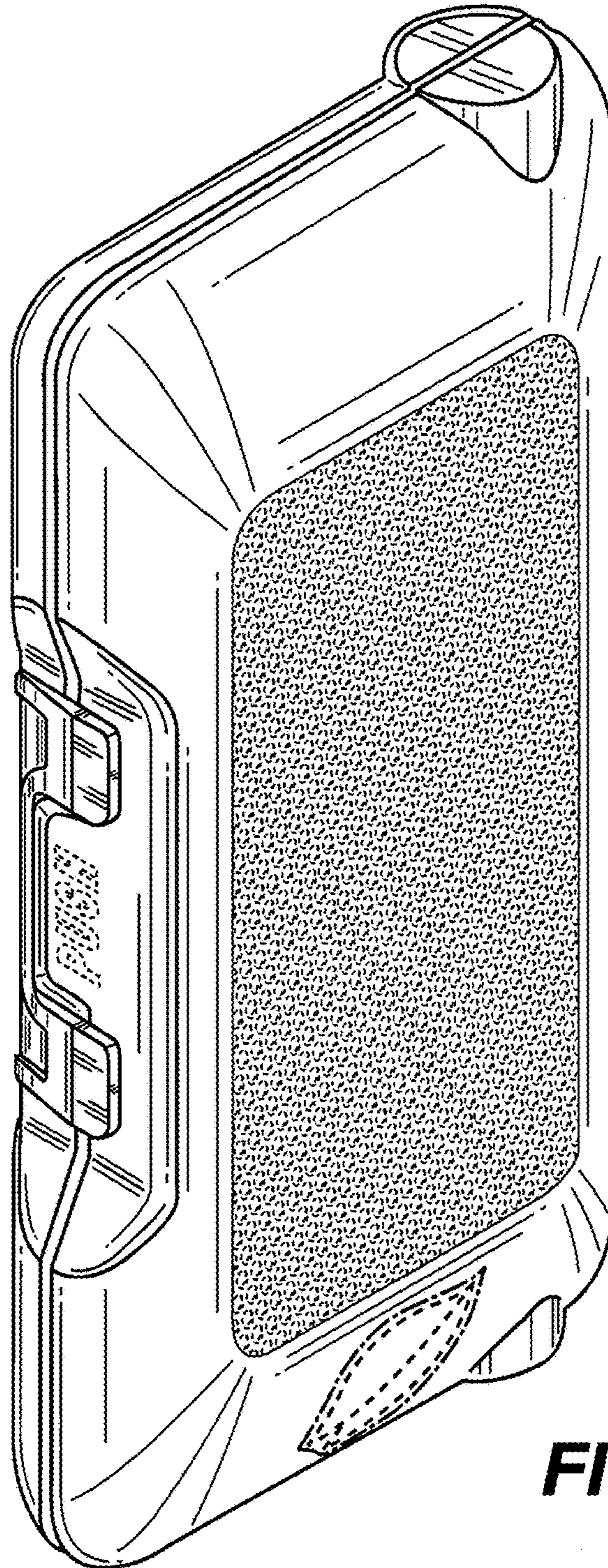
OTHER PUBLICATIONS

The Gadgeteer. White Cloud Cirrus E-Cigarette Review. Oct. 6, 2009 [earliest online date], [site visited Nov. 15, 2016]. Available from Internet, <URL:<http://the-gadgeteer.com/2009/10/06/white-cloud-cirrus-e-cigarette-review/>>.\*

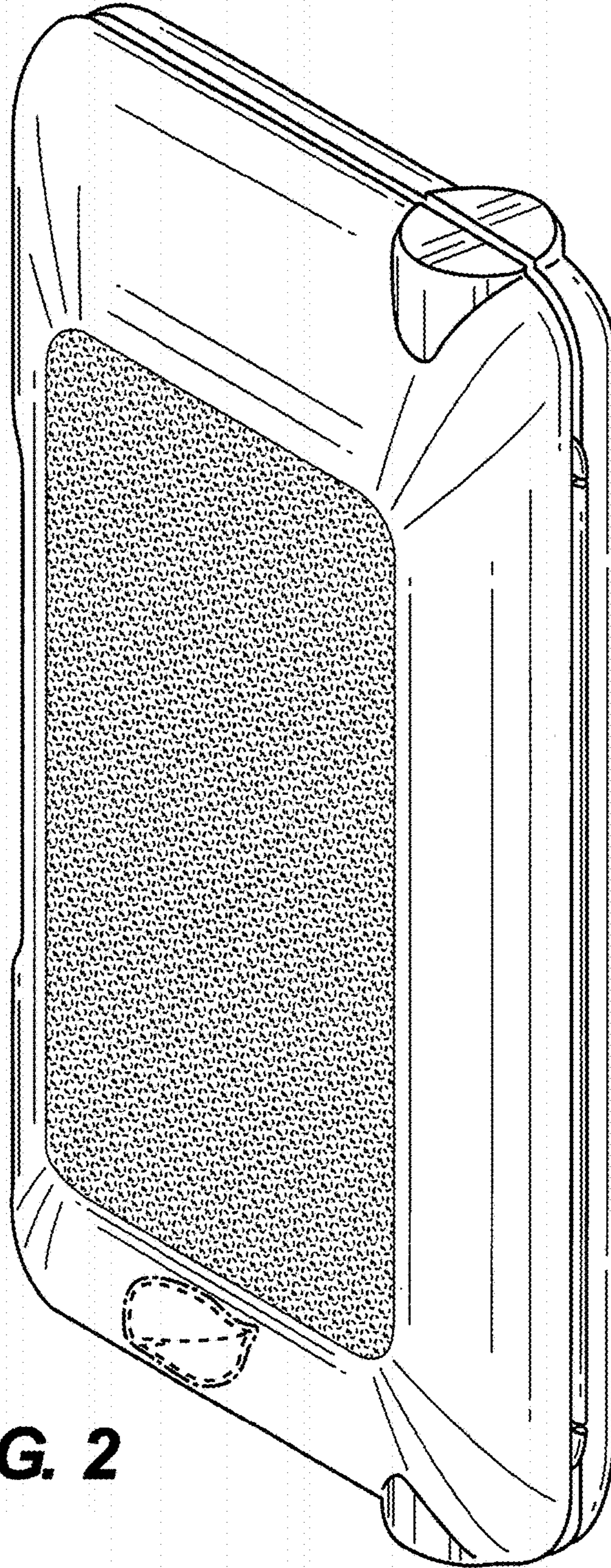
U.S. Office Action dated Dec. 16, 2016 issued in related U.S. Appl. No. 29/542,286.

\* cited by examiner



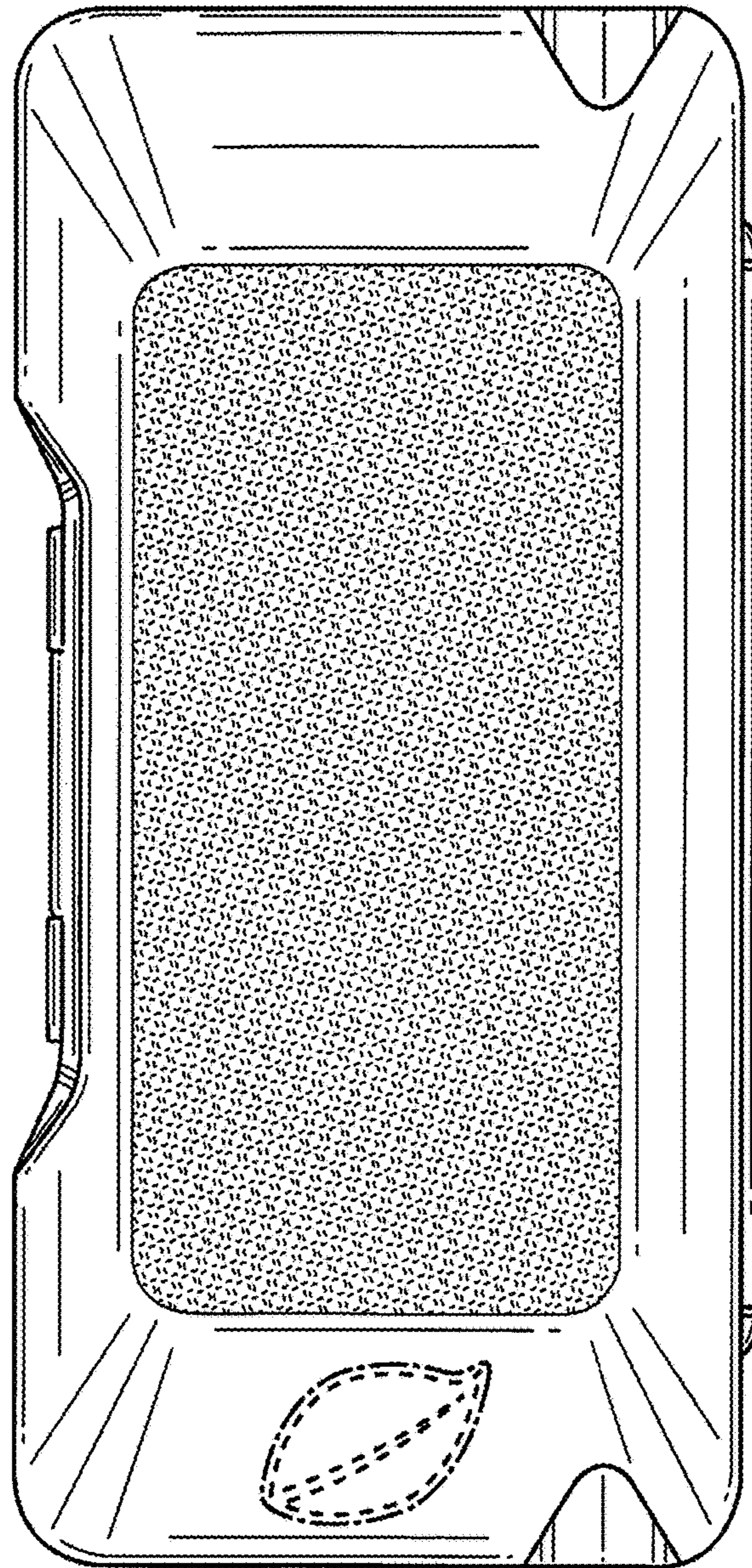


**FIG. 1**

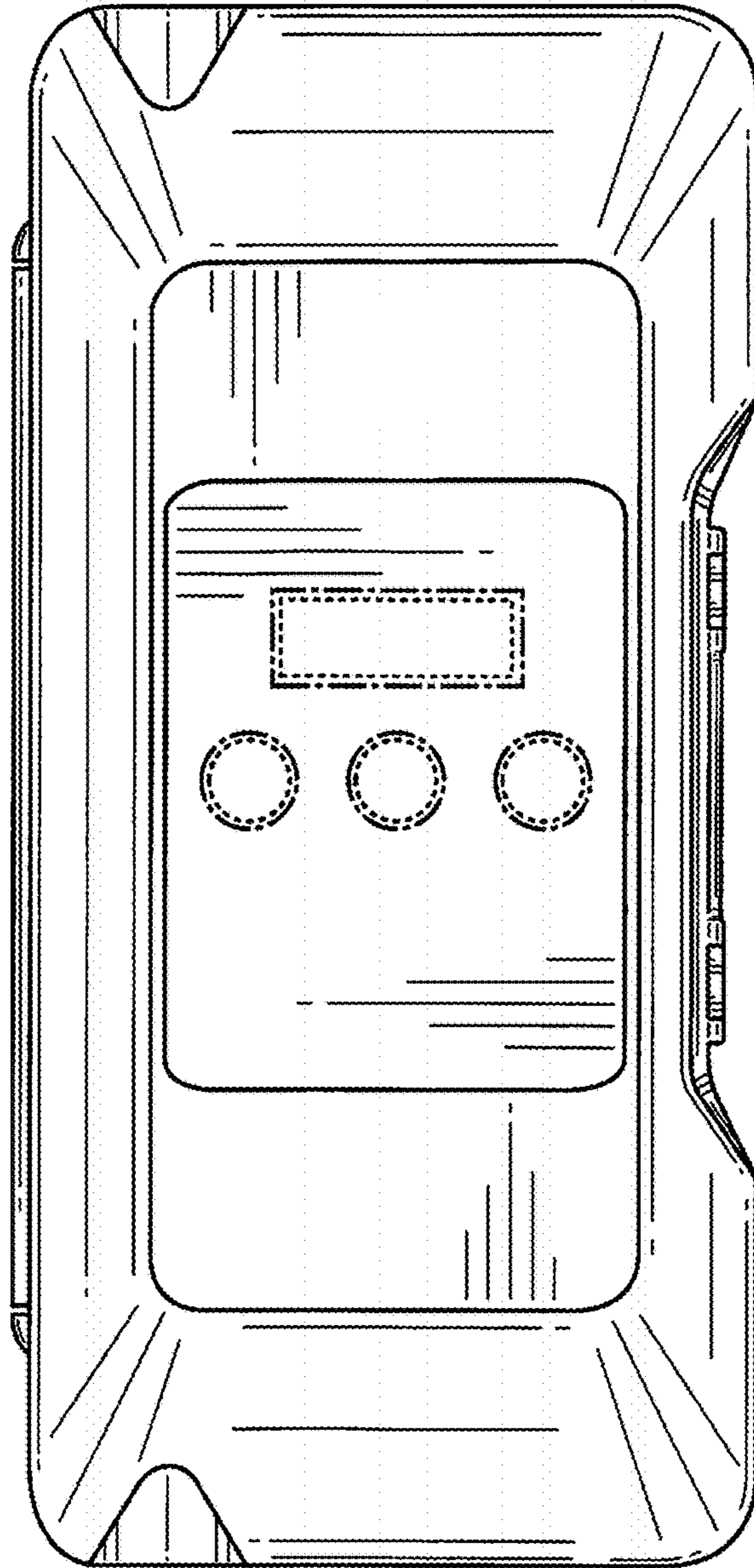


**FIG. 2**

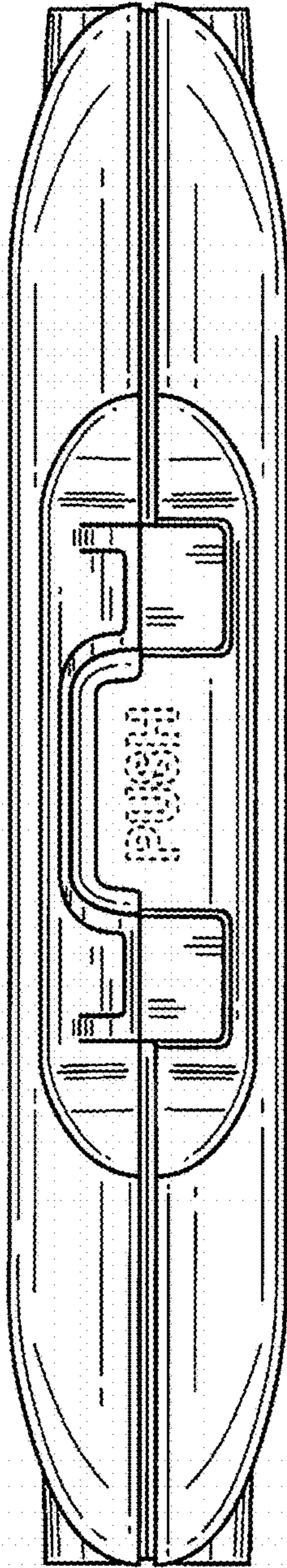




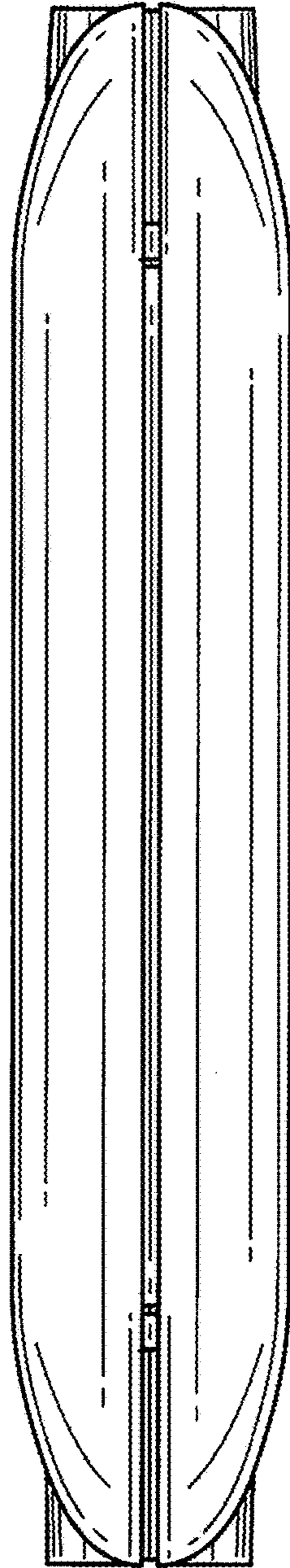
**FIG. 3**



**FIG. 4**

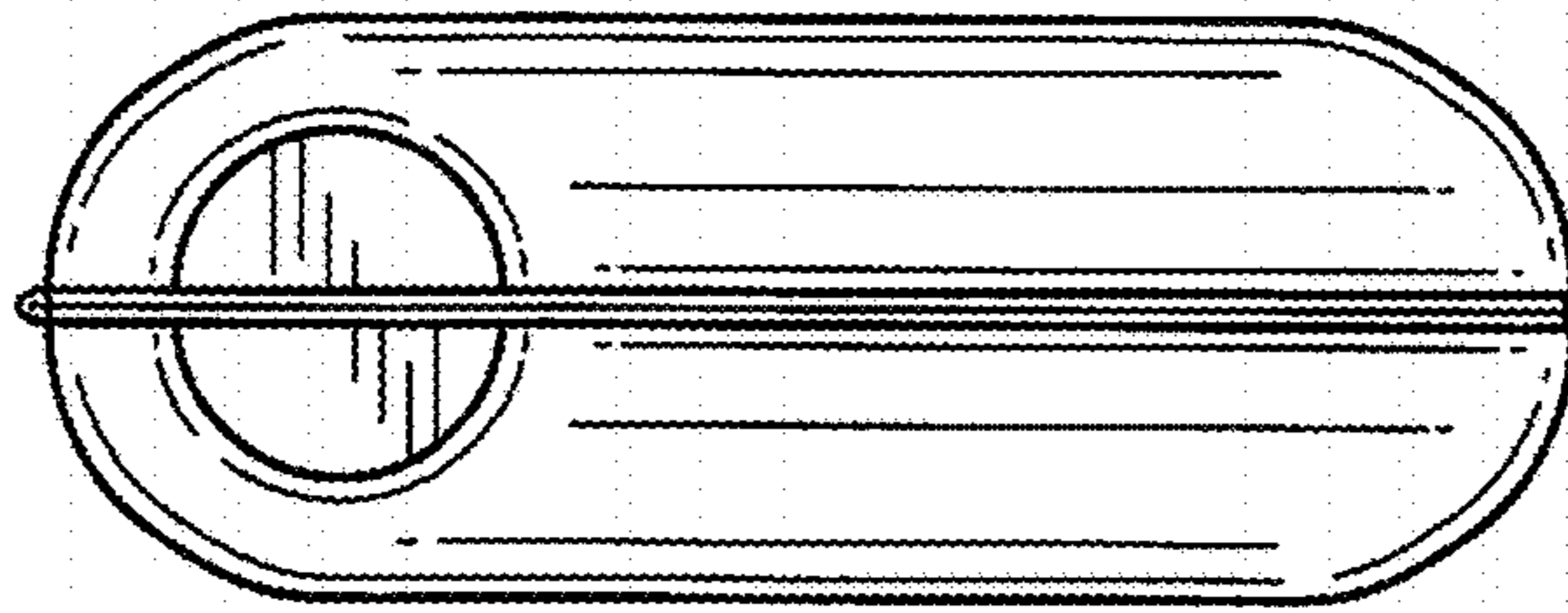


**FIG. 5**

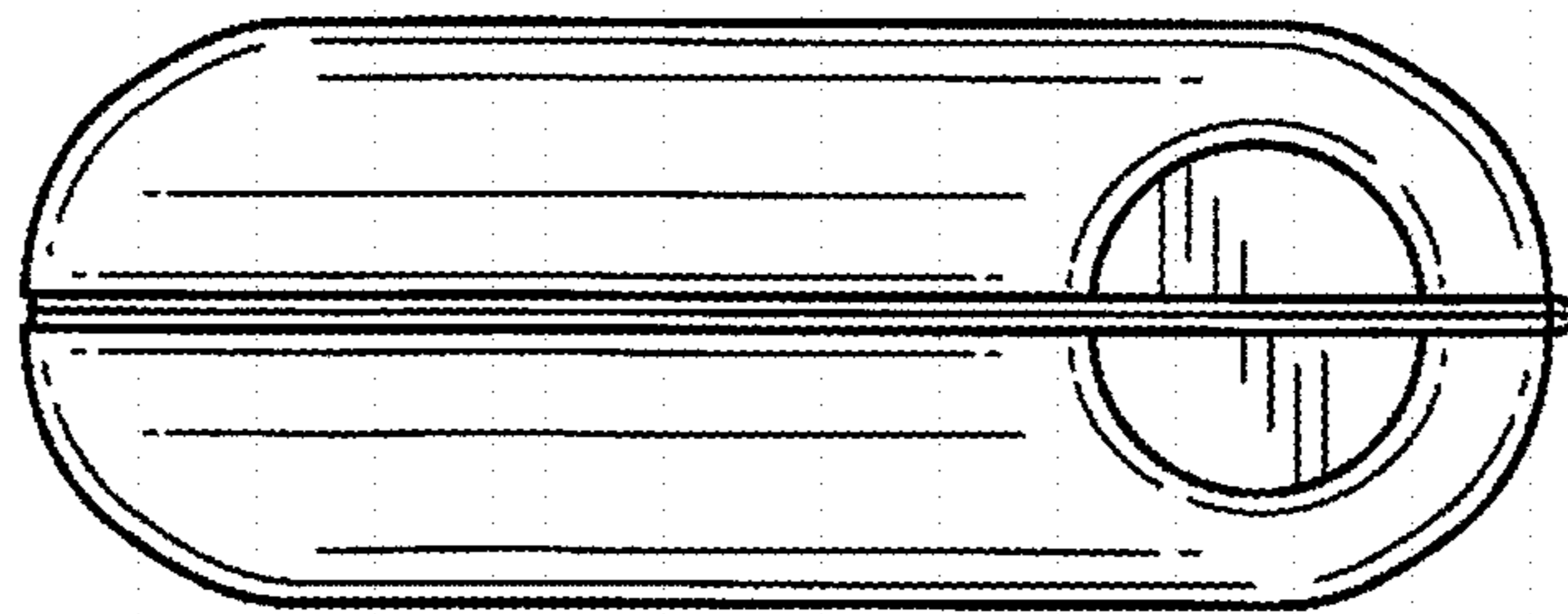


**FIG. 6**





**FIG. 7**



**FIG. 8**

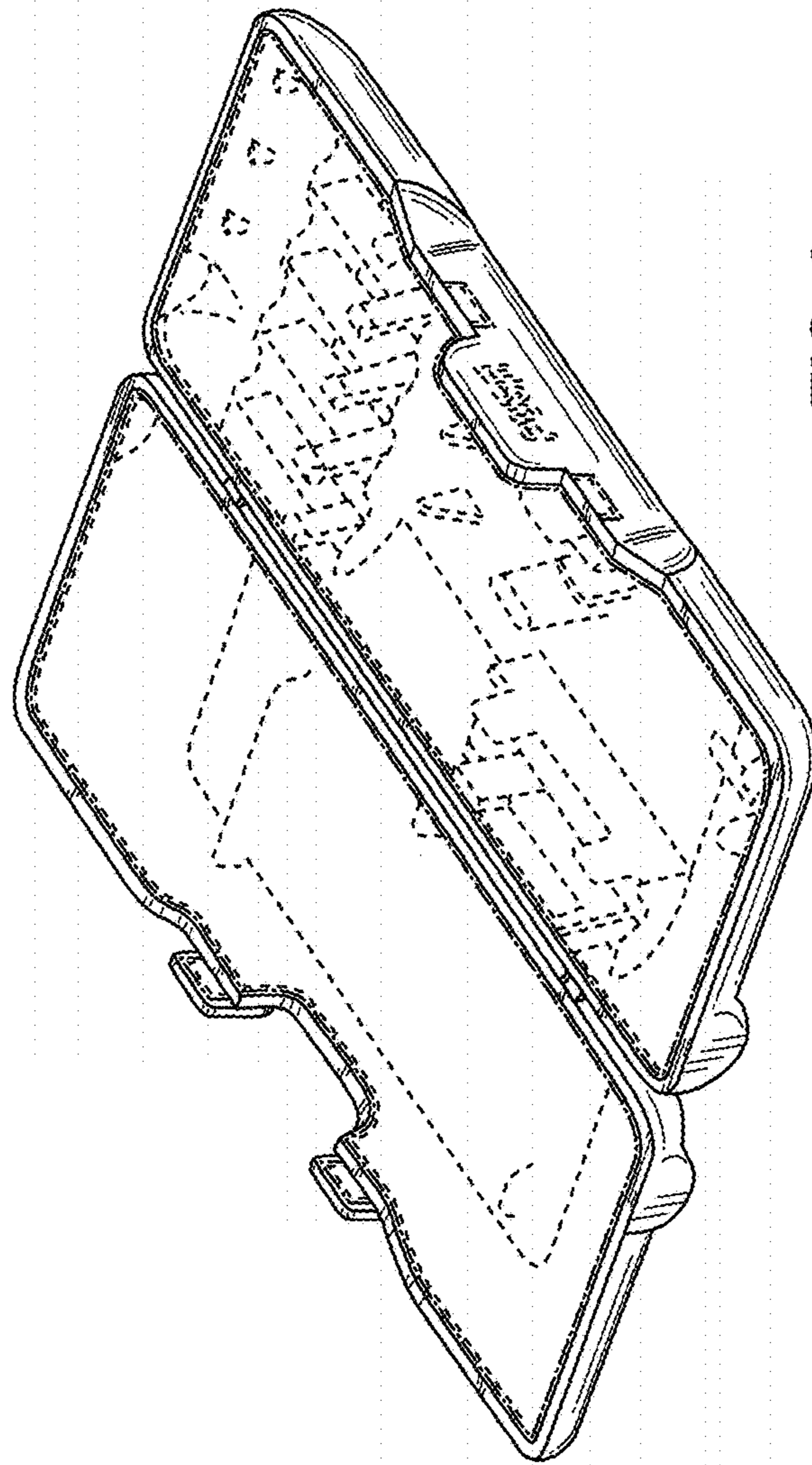


FIG. 9