



US00D794998S

(12) **United States Design Patent** (10) **Patent No.:** **US D794,998 S**
Cho et al. (45) **Date of Patent:** **** *Aug. 22, 2017**

(54) **ELECTRIC OVEN RANGE**

F24C 15/02; F24C 15/04; F24C 15/10;
F24C 15/102; F24C 15/107; F24C 15/325

See application file for complete search history.

(71) Applicant: **LG ELECTRONICS INC.**, Seoul
(KR)

(56) **References Cited**

(72) Inventors: **Sangwoog Cho**, Seoul (KR); **Sooyeon Kim**, Seoul (KR); **Jaehun Chung**, Seoul (KR)

U.S. PATENT DOCUMENTS

(73) Assignee: **LG ELECTRONICS INC.**, Seoul
(KR)

D375,867 S *	11/1996	Sparks	D7/340
D464,229 S *	10/2002	Baldwin	D7/340
D511,925 S *	11/2005	Baldwin	D7/340
D530,152 S *	10/2006	Pryor	D7/405
D530,971 S *	10/2006	Kim	D7/340
D536,208 S *	2/2007	Ostlund	D7/340
D542,079 S *	5/2007	Kim	D7/340
D564,281 S *	3/2008	Kim	D7/340
D564,836 S *	3/2008	Crookshanks	D7/405
D612,678 S *	3/2010	Baker	D7/405
D642,007 S *	7/2011	Lee	D7/340
D670,527 S *	11/2012	Kim	D7/340
2010/0006085 A1 *	1/2010	Thomas	F24C 15/325 126/21 A

(*) Notice: This patent is subject to a terminal disclaimer.

(**) Term: **15 Years**

* cited by examiner

(21) Appl. No.: **29/534,908**

Primary Examiner — Ricky Pham

(22) Filed: **Jul. 31, 2015**

(74) *Attorney, Agent, or Firm* — Birch, Stewart, Kolasch & Birch, LLP

(30) **Foreign Application Priority Data**

Feb. 3, 2015 (KR) 30-2015-0005912

(57) **CLAIM**

(51) **LOC (10) Cl.** **07-02**

We claim the ornamental design for an electric oven range, as shown and described.

(52) **U.S. Cl.**
USPC **D7/340**

(58) **Field of Classification Search**

USPC D7/323, 328-330, 339-349, 390,
D7/402-406; D8/300-306
CPC ... A21B 2/00; A47J 27/04; A47J 37/00; A47J
37/06; A47J 37/0611; A47J 37/08; A47J
37/0807; A47J 37/0814; A47J 37/0835;
A47J 37/0842; A47J 37/085; A47J
37/0864; A47J 37/0878; A47J 37/0885;
A47J 37/0892; F24B 1/02; F24C 7/00;
F24C 7/002; F24C 7/046; F24C 7/067;

DESCRIPTION

FIG. 1 is a perspective view of an electric oven range showing our new design;
FIG. 2 is a front elevation view thereof;
FIG. 3 is a rear elevation view thereof;
FIG. 4 is a left-side elevation view thereof;
FIG. 5 is a right-side elevation view thereof;
FIG. 6 is a top plan view thereof; and,
FIG. 7 is a bottom plan view thereof.

(Continued)

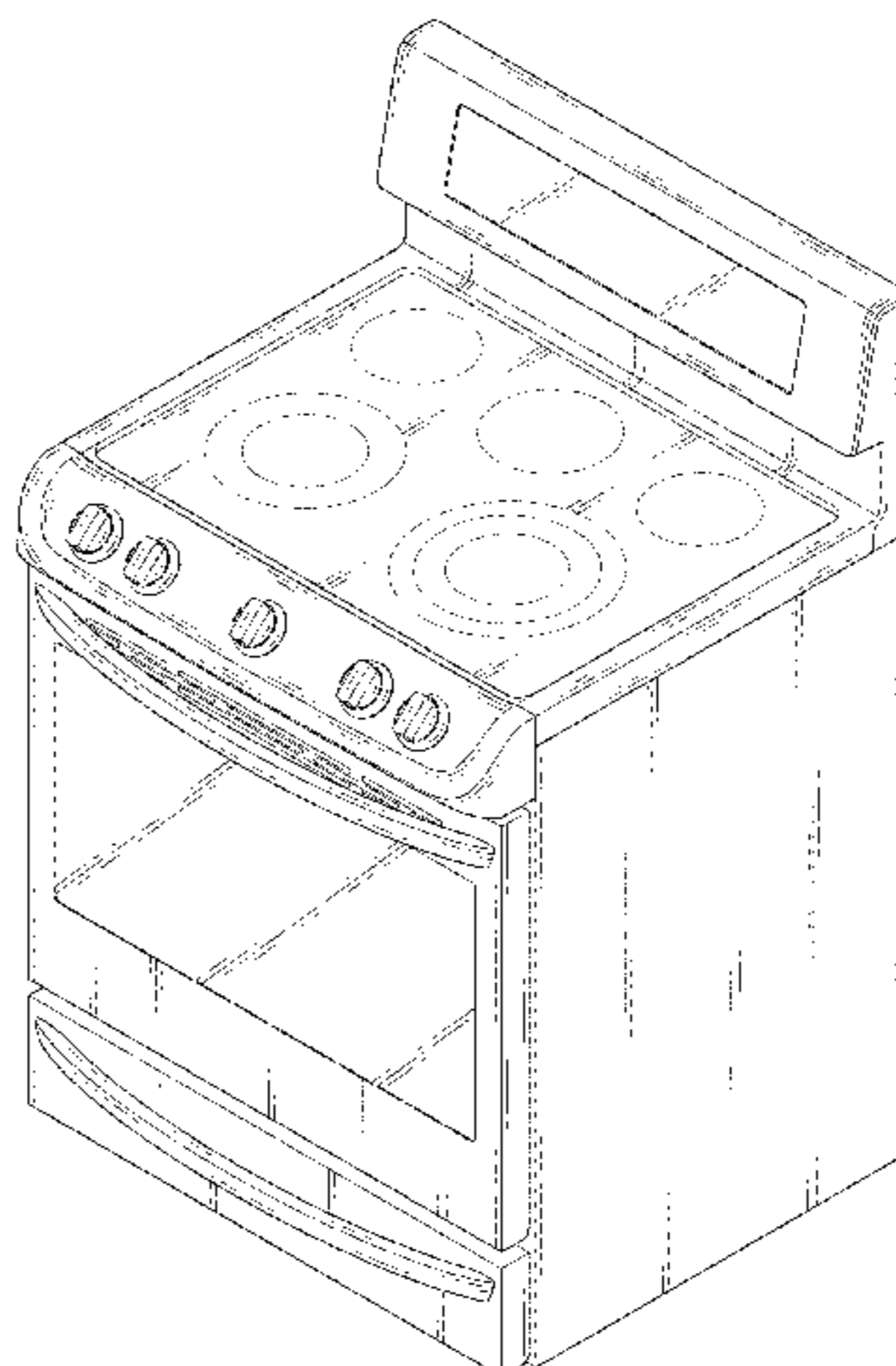

The broken lines in the drawing figures are included for the purpose of illustrating environment and form no part of the claimed design.

1 Claim, 6 Drawing Sheets

FIG. 1

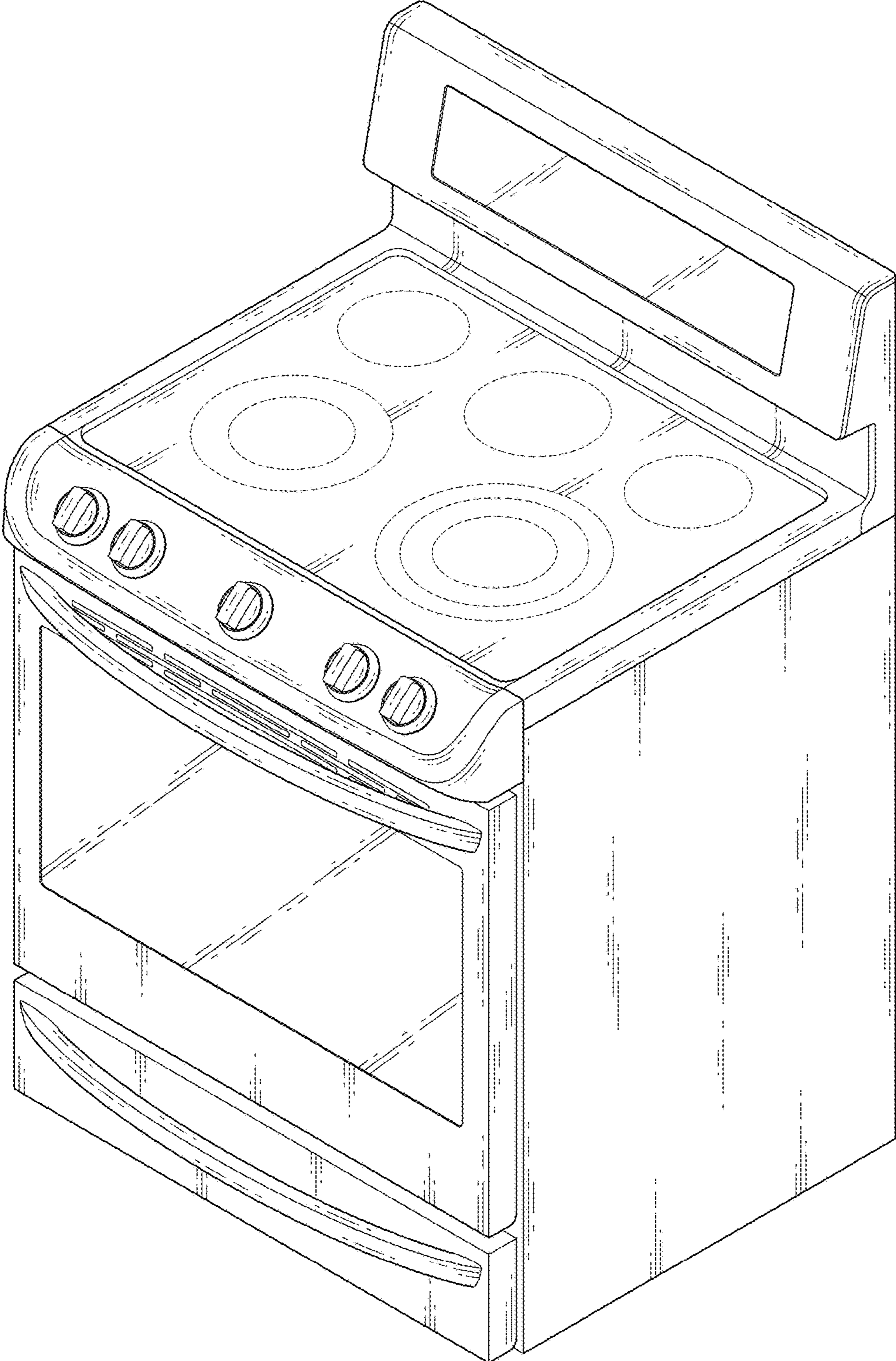

FIG. 2

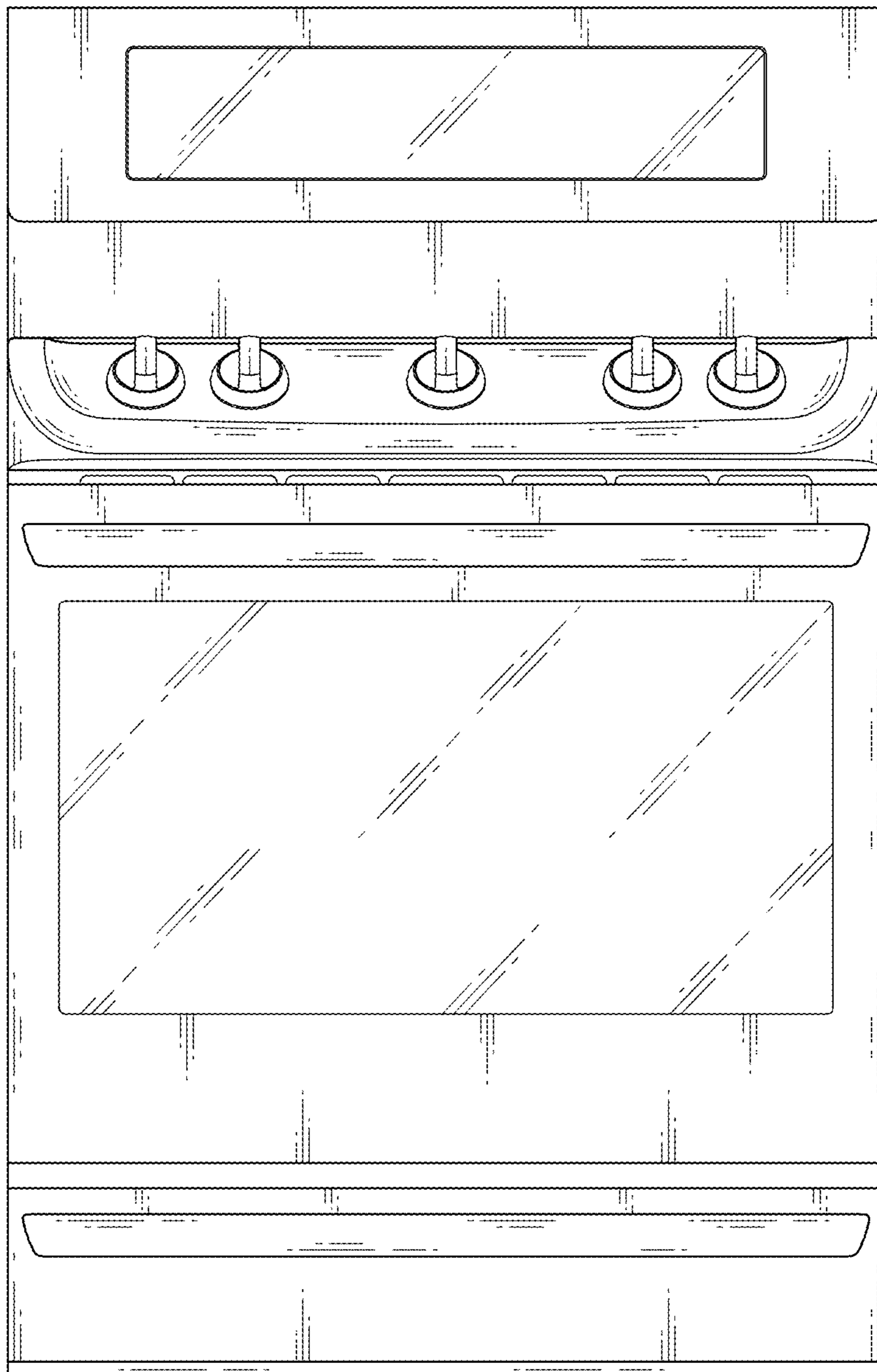

FIG. 3

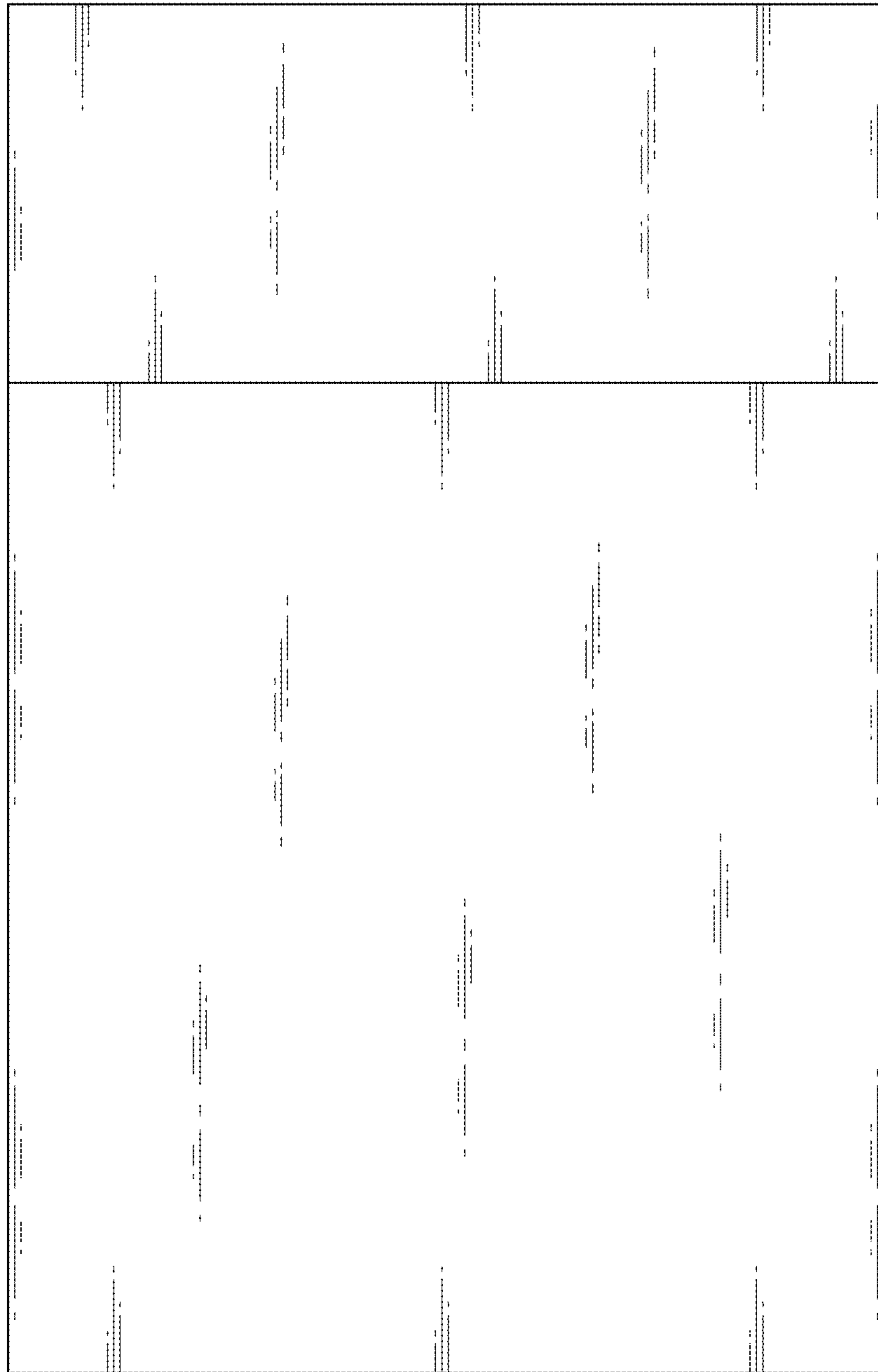

FIG. 4

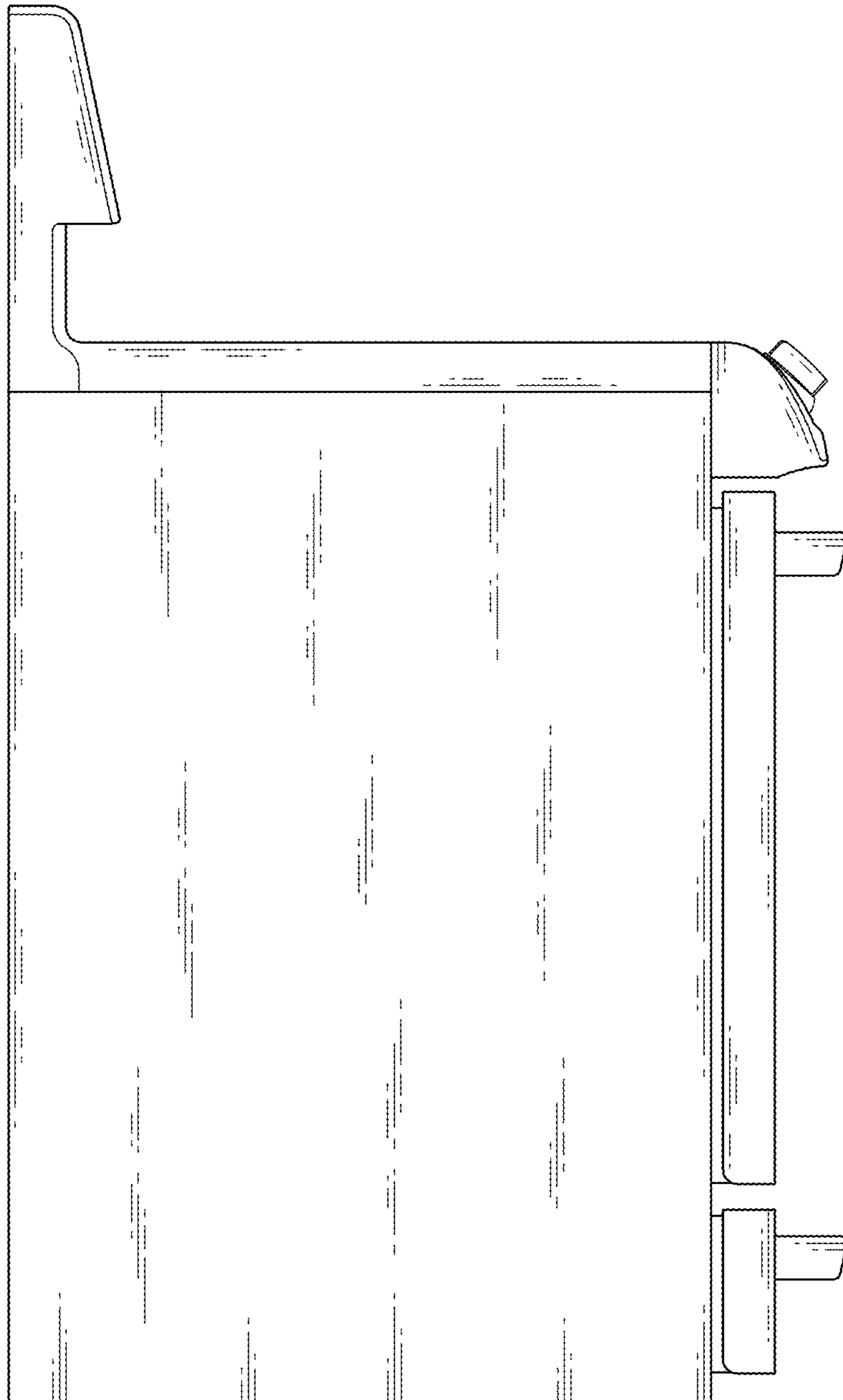

FIG. 5

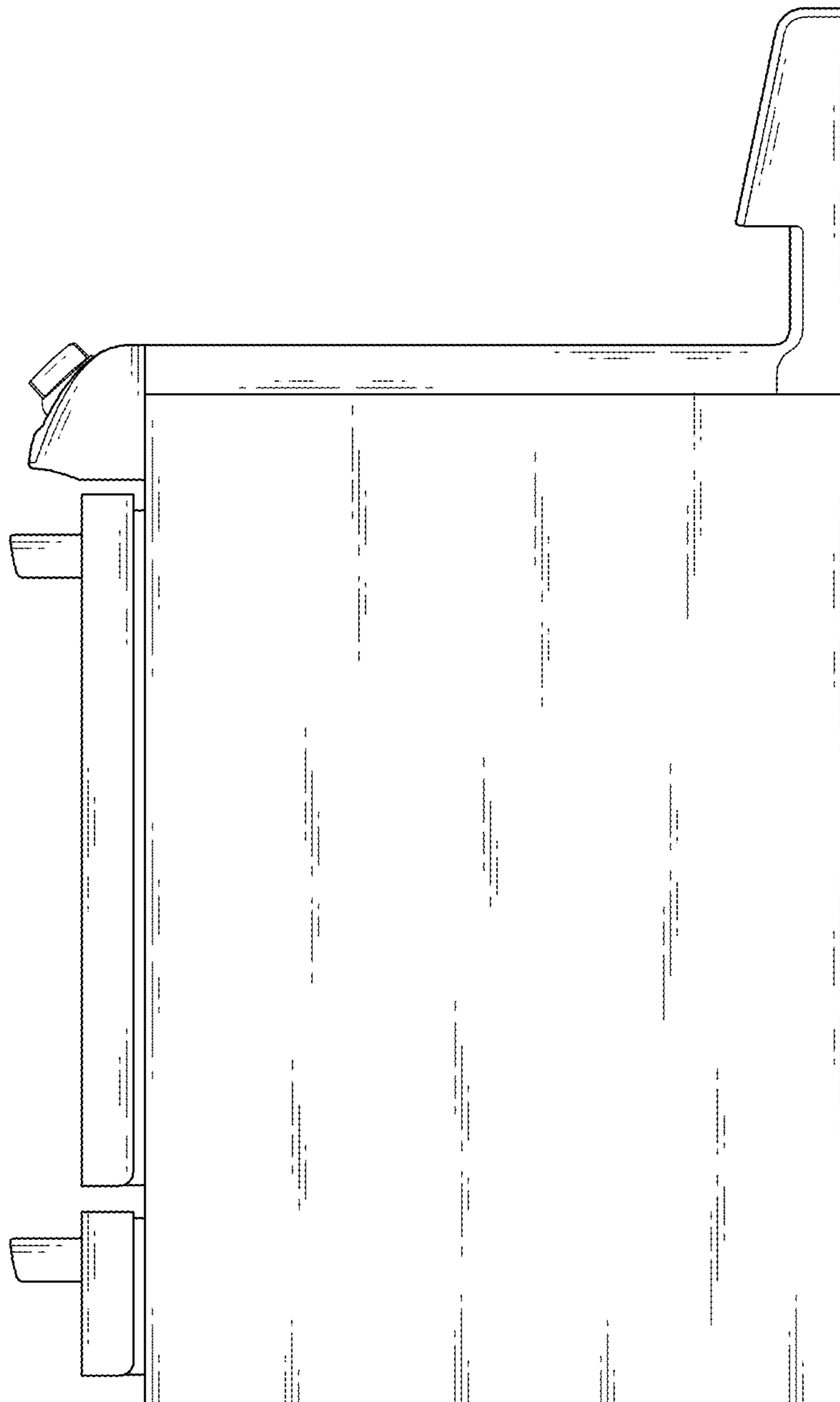

FIG. 6

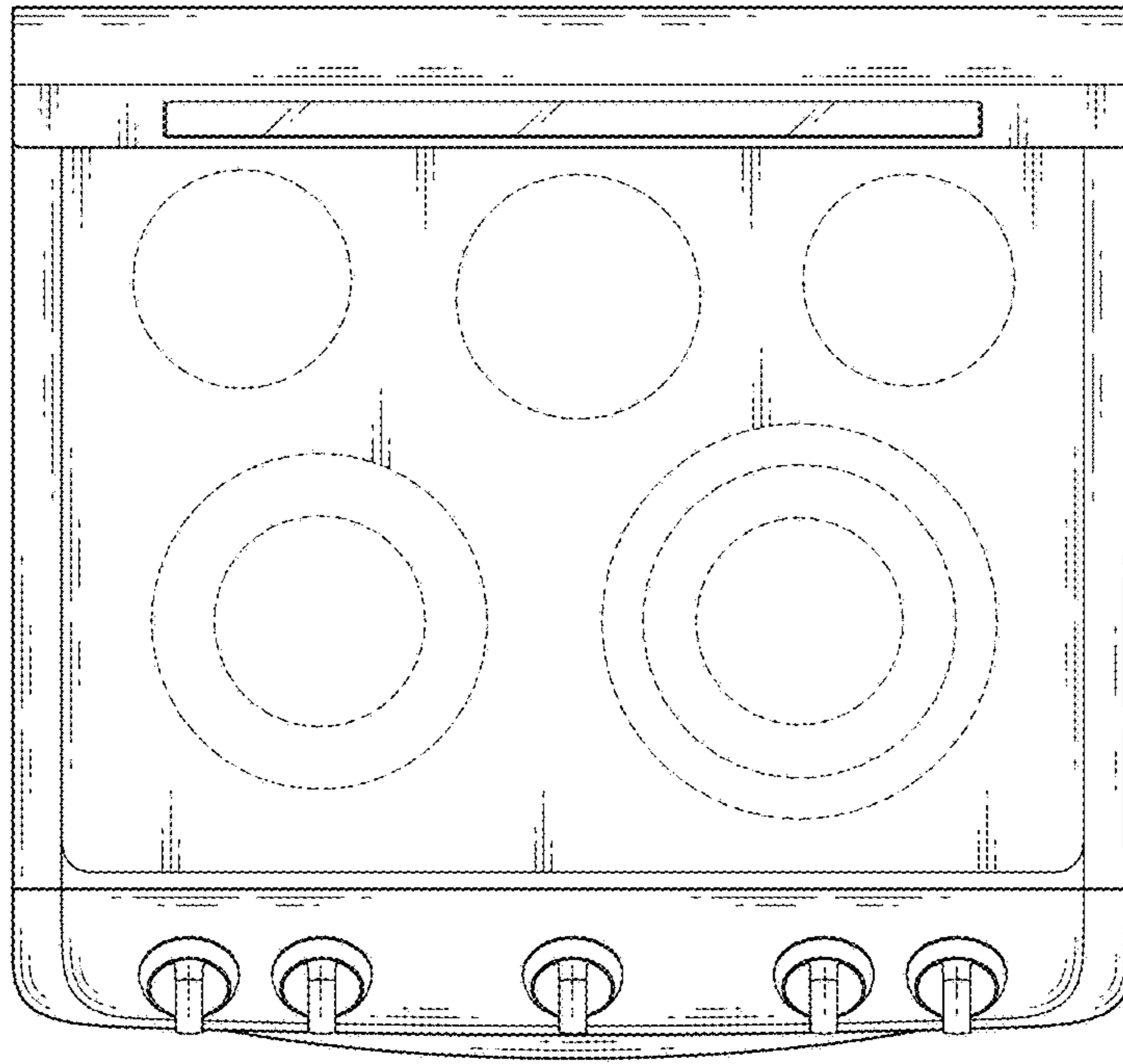

FIG. 7

