



US00D794995S

(12) **United States Design Patent**
Bond et al.

(10) **Patent No.:** **US D794,995 S**

(45) **Date of Patent:** **** Aug. 22, 2017**

(54) **TOASTER**

(71) Applicant: **Nostalgia Products LLC**, Green Bay, WI (US)

(72) Inventors: **Gregg Bond**, Beverly Hills, CA (US);
Edward E. Boughton, III, Ventura, CA (US)

(73) Assignee: **NOSTALGIA PRODUCTS LLC**, Green Bay, WI (US)

(**) Term: **15 Years**

(21) Appl. No.: **29/544,203**

(22) Filed: **Oct. 30, 2015**

(51) **LOC (10) Cl.** **07-02**

(52) **U.S. Cl.**
USPC **D7/330**

(58) **Field of Classification Search**
USPC D7/323, 328-330, 390
CPC ... A21B 2/00; A47J 37/00; A47J 37/06; A47J 37/0611; A47J 37/08; A47J 37/0807; A47J 37/0814; A47J 37/0835; A47J 37/0842; A47J 37/085; A47J 37/0864; A47J 37/0878; A47J 37/0885; A47J 37/0892; F24C 15/10; F24C 15/102
See application file for complete search history.

(56) **References Cited**

U.S. PATENT DOCUMENTS

D509,702 S	*	9/2005	Picozza	D7/330
D520,801 S	*	5/2006	Cuffaro	D7/330
D527,568 S	*	9/2006	Page	D7/330
D567,570 S	*	4/2008	O'Loughlin	D7/330
D593,357 S	*	6/2009	Picozza	D7/330
D622,092 S	*	8/2010	Picozza	D7/330
D688,509 S	*	8/2013	Carlson	D7/330
D701,720 S	*	4/2014	Palermo	D7/330
D724,885 S	*	3/2015	Kunz	D7/330

D746,093 S	*	12/2015	Bazzicalupo	D7/330
D746,624 S	*	1/2016	Sun	D7/330
D761,610 S	*	7/2016	Carpenter	D7/330
D765,456 S	*	9/2016	Lee	D7/330

* cited by examiner

Primary Examiner — Ricky Pham

(74) *Attorney, Agent, or Firm* — Blakely Sokoloff Taylor & Zafman LLP

(57) **CLAIM**

The ornamental design for toaster, as shown and described.

DESCRIPTION

FIG. 1 is a perspective view illustrating our new design.
 FIG. 2 is a right side elevation view thereof.
 FIG. 3 is a left side elevation view thereof.
 FIG. 4 is a front elevation view thereof.
 FIG. 5 is a rear elevation view thereof.
 FIG. 6 is a top plan view thereof.
 FIG. 7 is a bottom plan view thereof.
 FIG. 8 is a perspective view of a first alternate embodiment of our new design.
 FIG. 9 is a right side elevation view thereof.
 FIG. 10 is a left side elevation view thereof.
 FIG. 11 is a front elevation view thereof.
 FIG. 12 is a rear elevation view thereof.
 FIG. 13 is a top plan view thereof.
 FIG. 14 is a bottom plan view thereof.
 FIG. 15 is a perspective view of a second alternate embodiment of our new design.
 FIG. 16 is a right side elevation view thereof.
 FIG. 17 is a left side elevation view thereof.
 FIG. 18 is a front elevation view thereof.
 FIG. 19 is a rear elevation view thereof.
 FIG. 20 is a top plan view thereof; and,
 FIG. 21 is a bottom plan view thereof.
 The broken lines shown in the drawings are for illustrative purposes only and form no part of the claimed design.

1 Claim, 21 Drawing Sheets

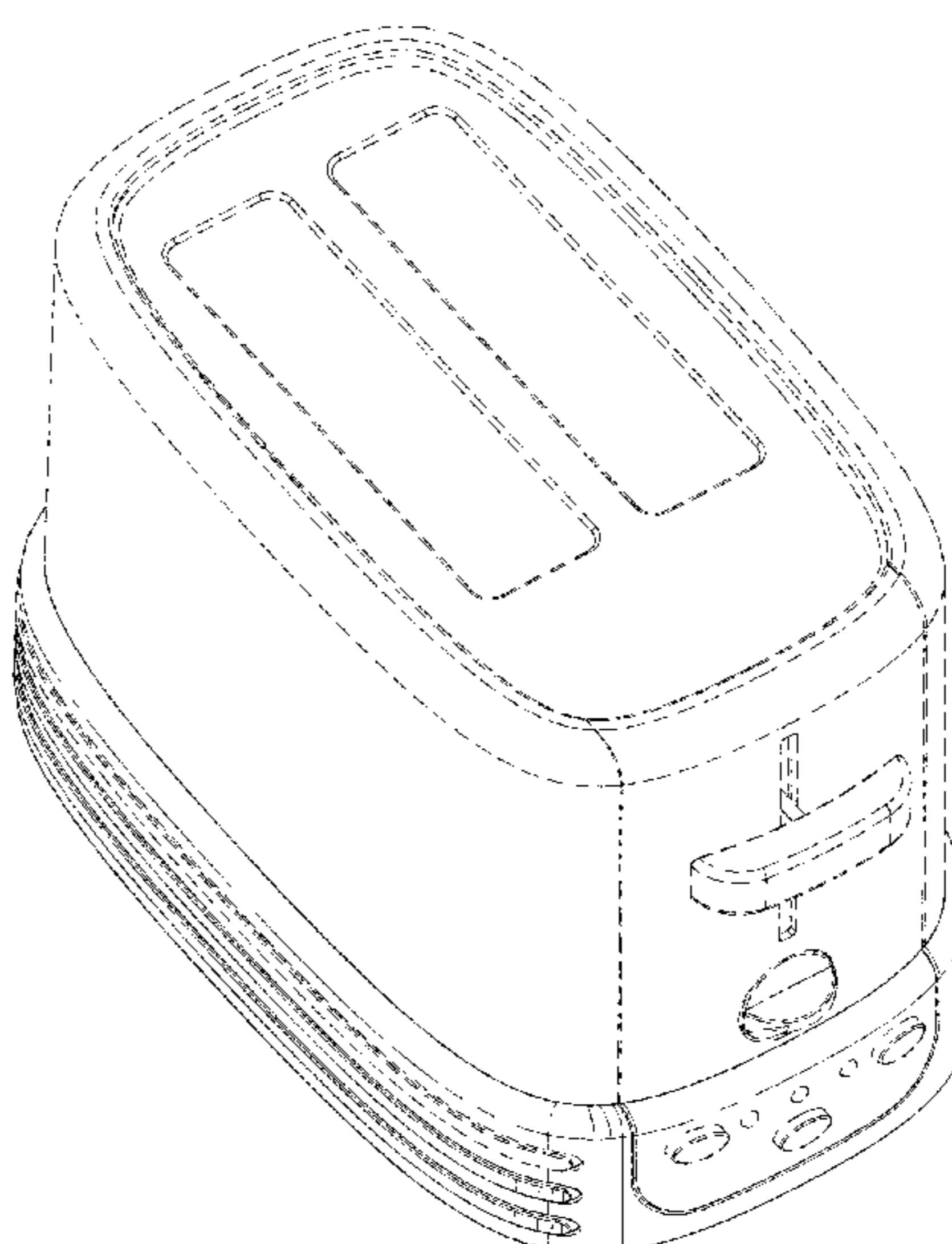
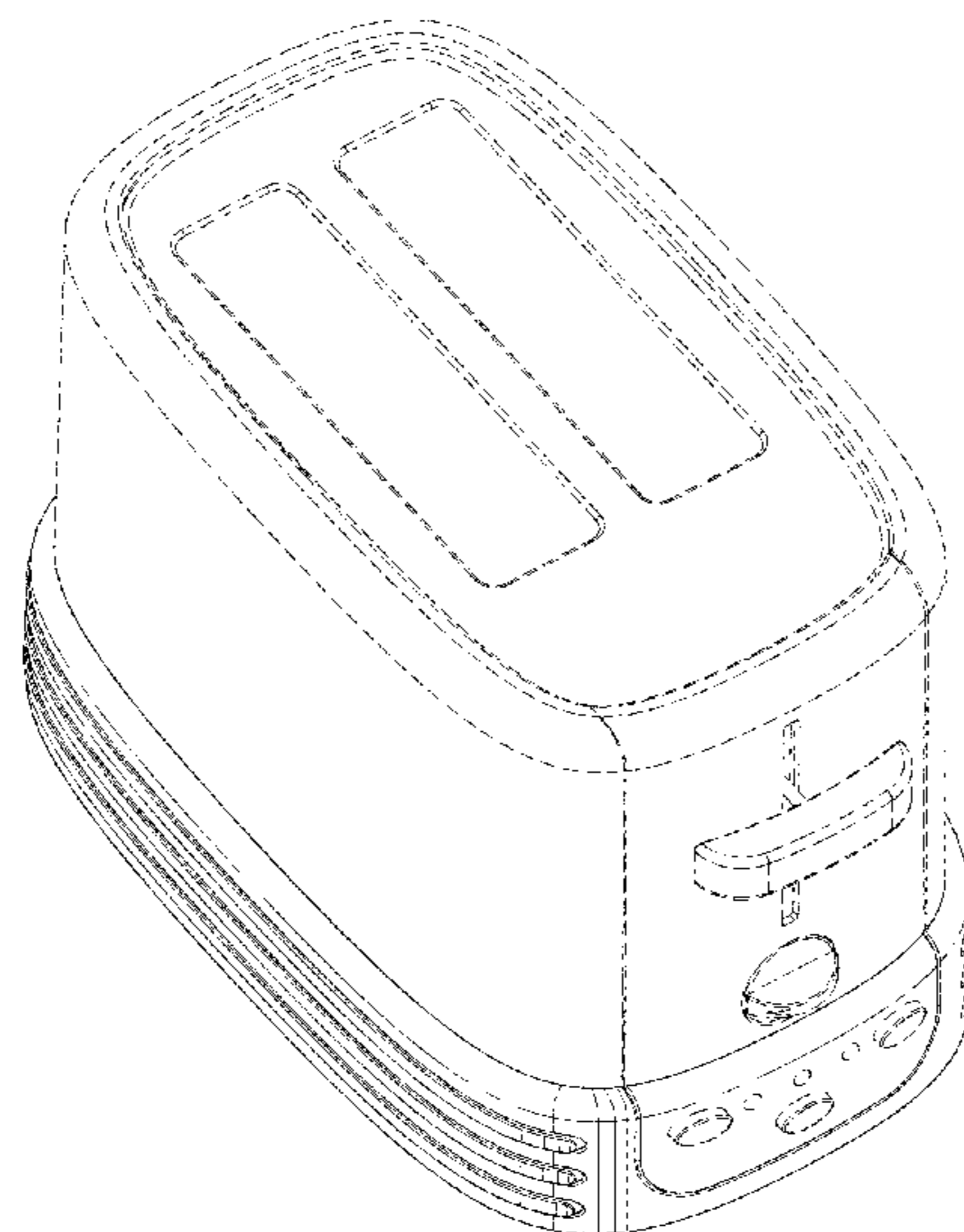

FIG. 1

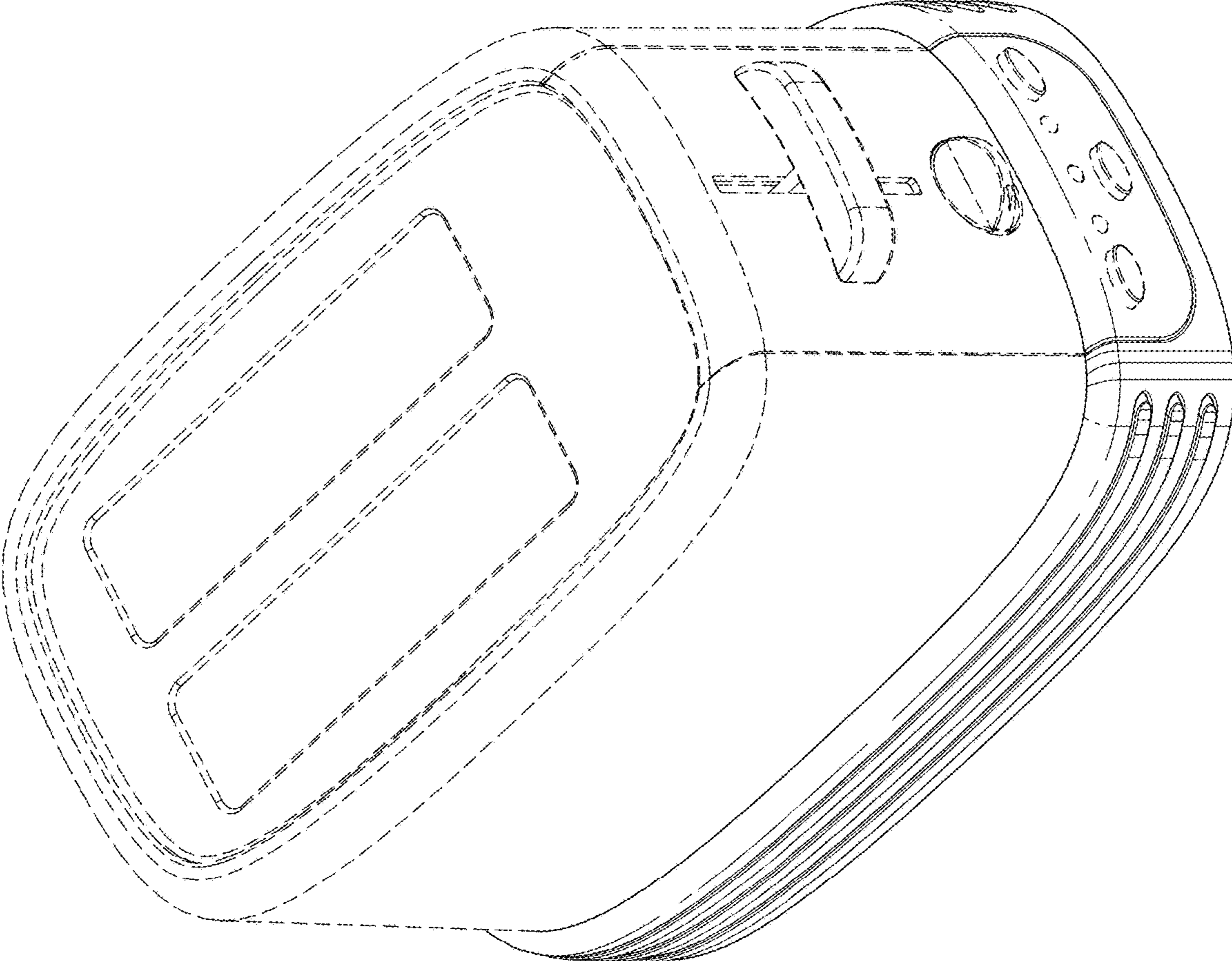

FIG. 2

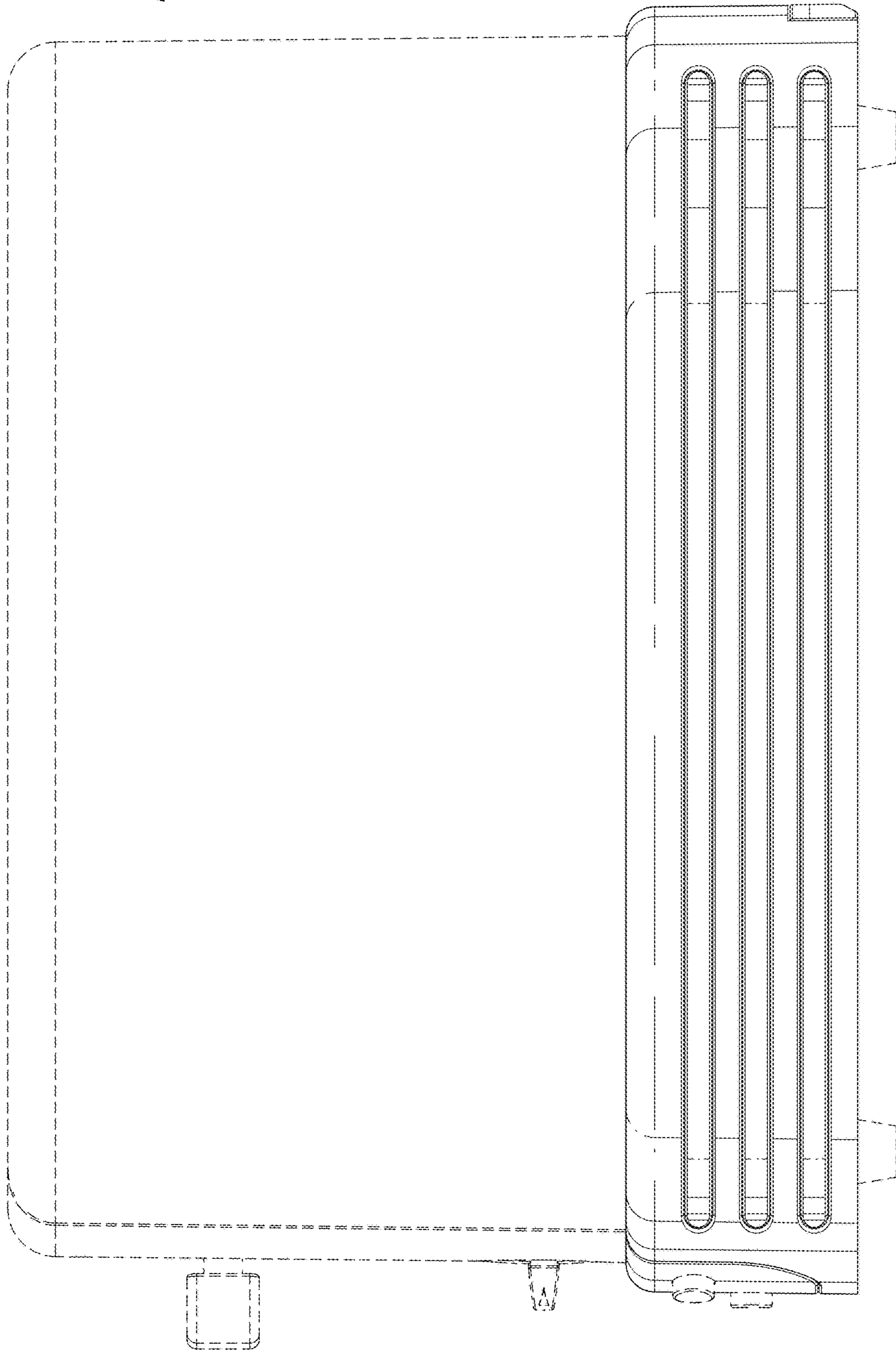
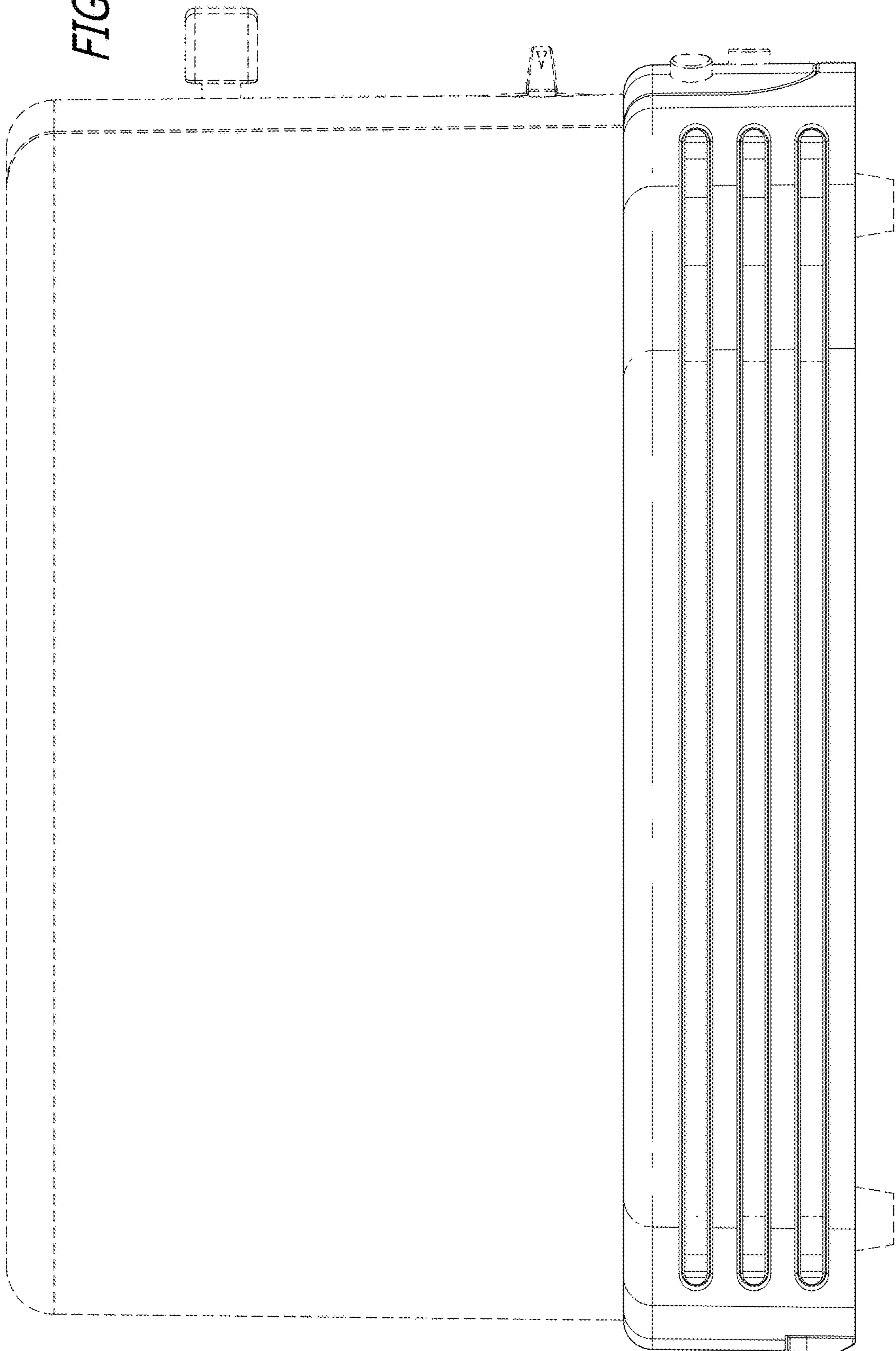

FIG. 3



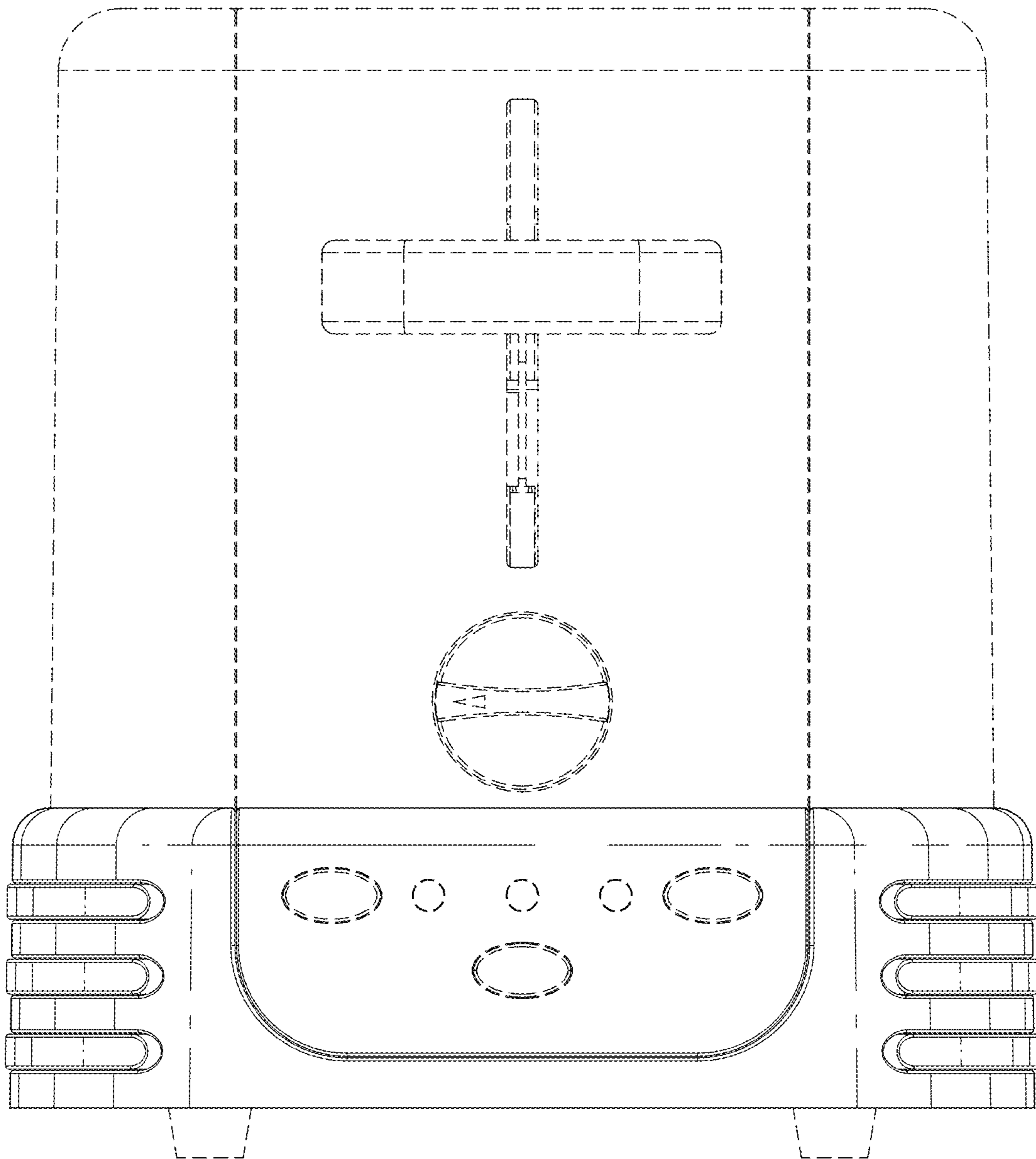

FIG. 4

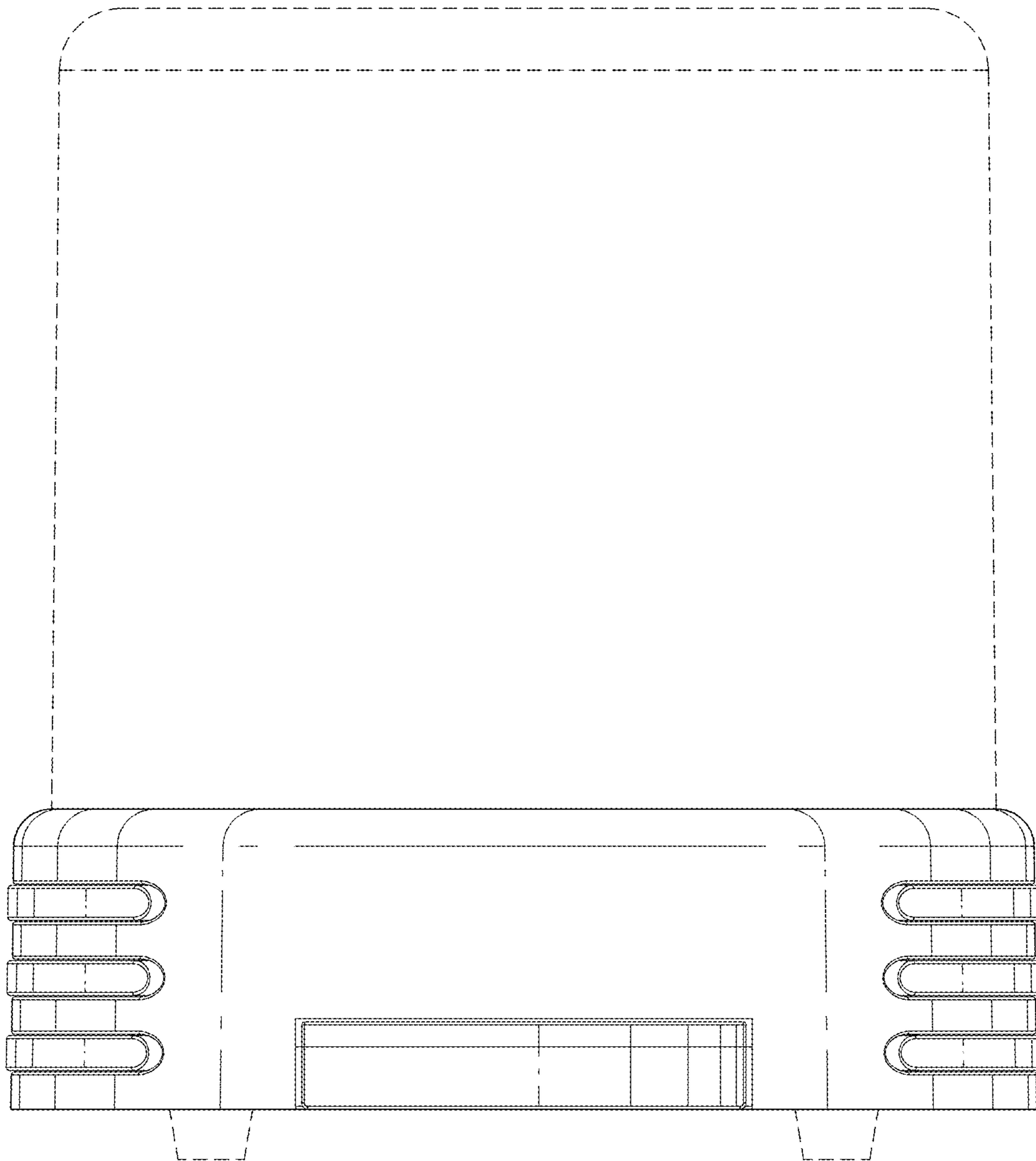

FIG. 5

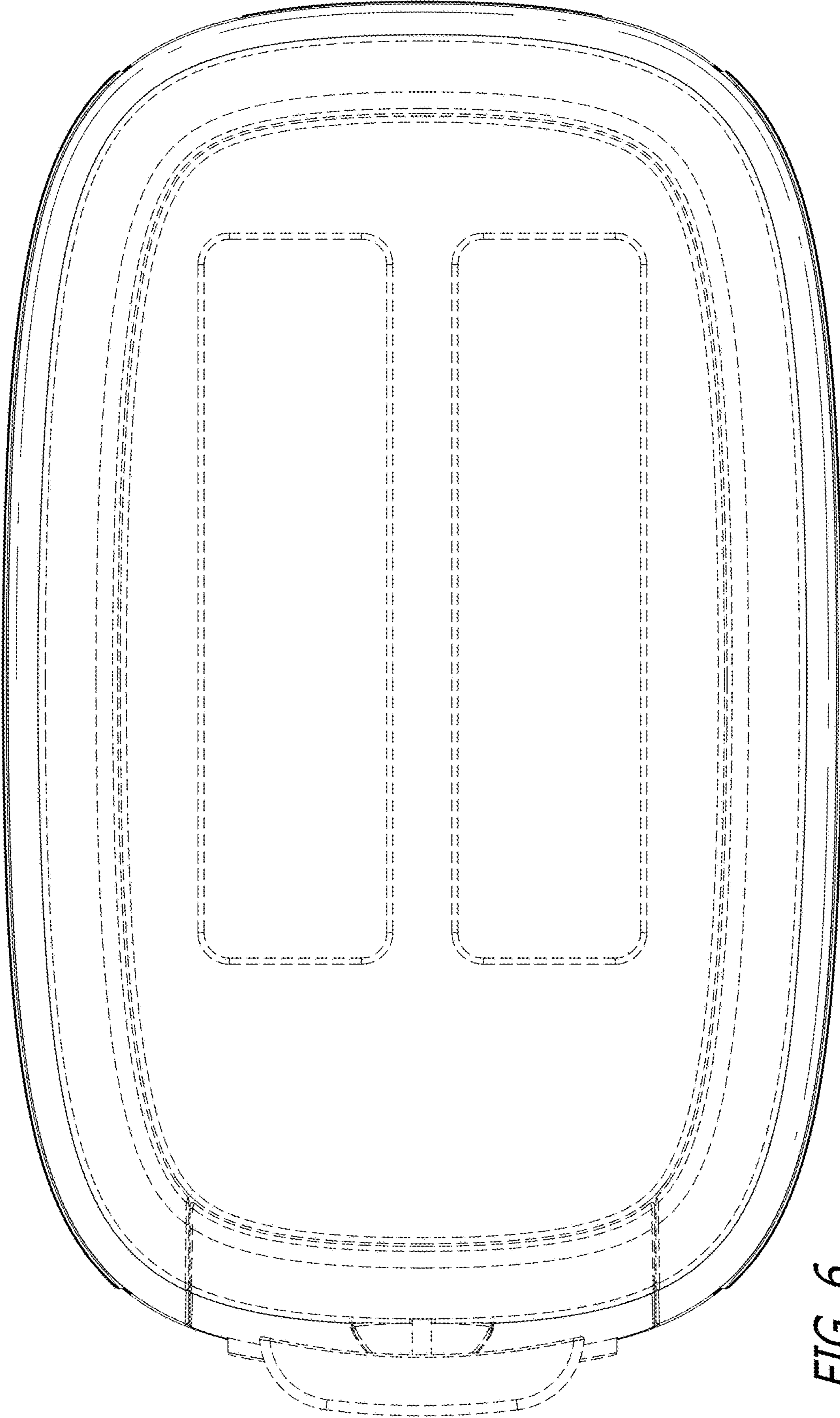

FIG. 6

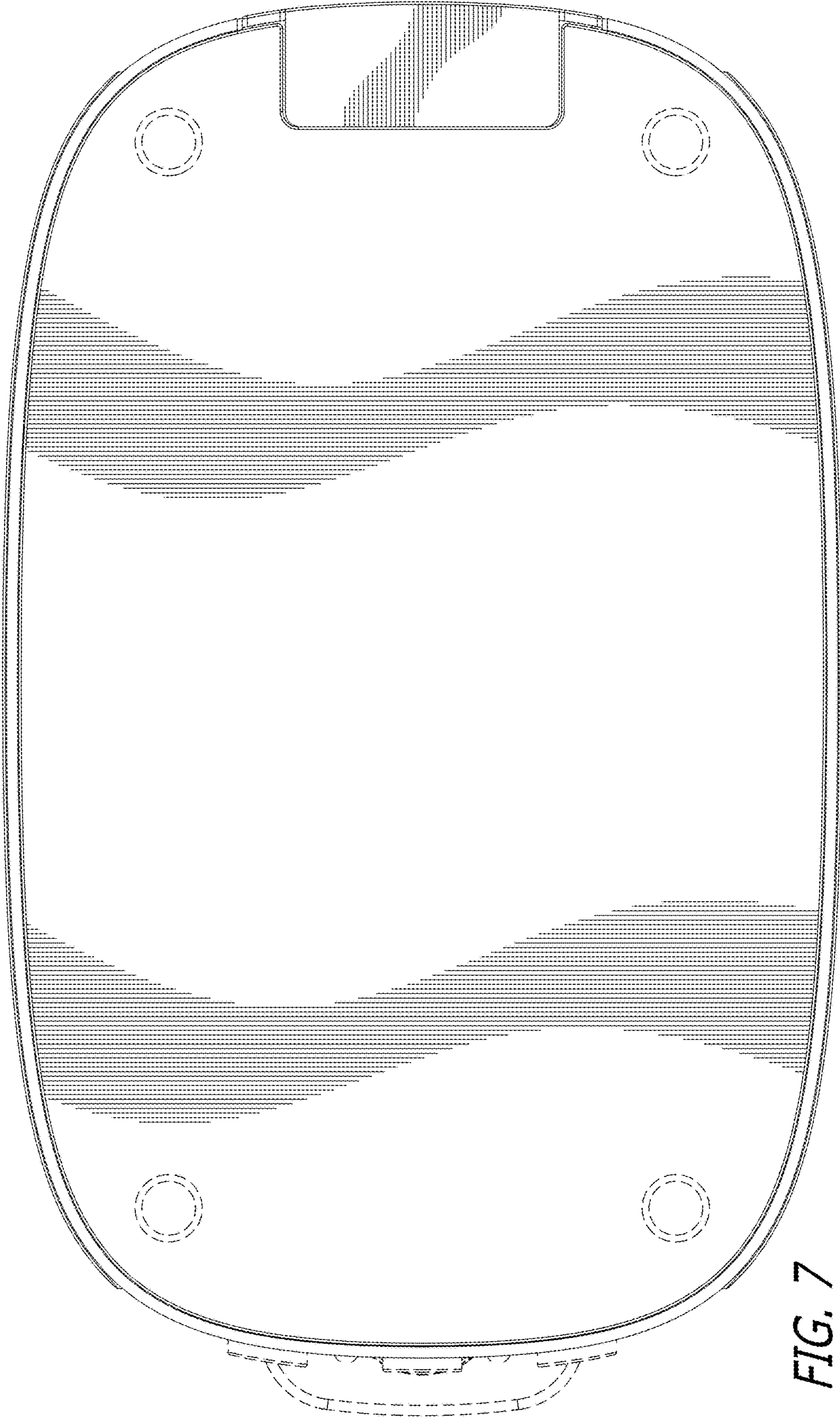

FIG. 7

FIG. 8

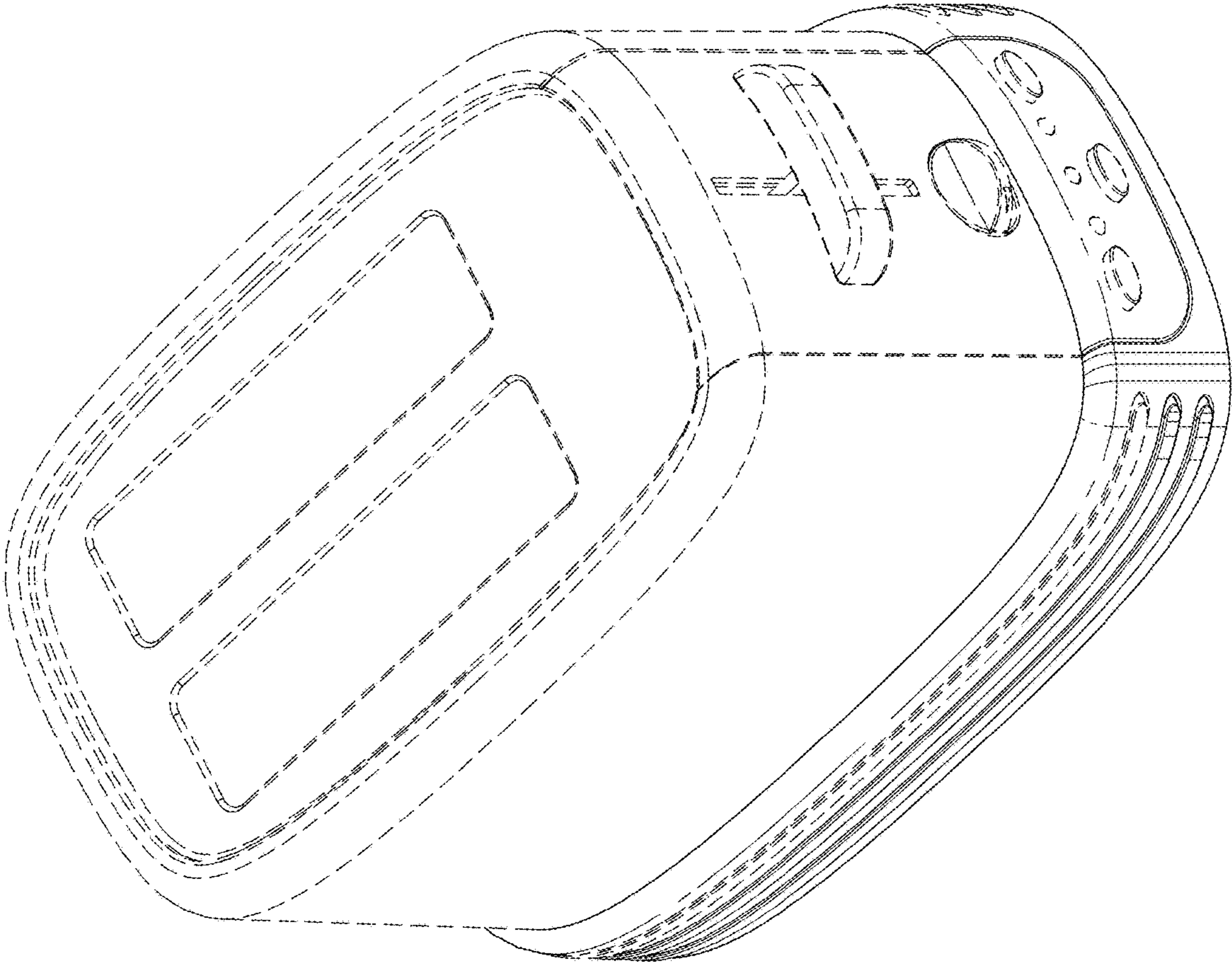

FIG. 9

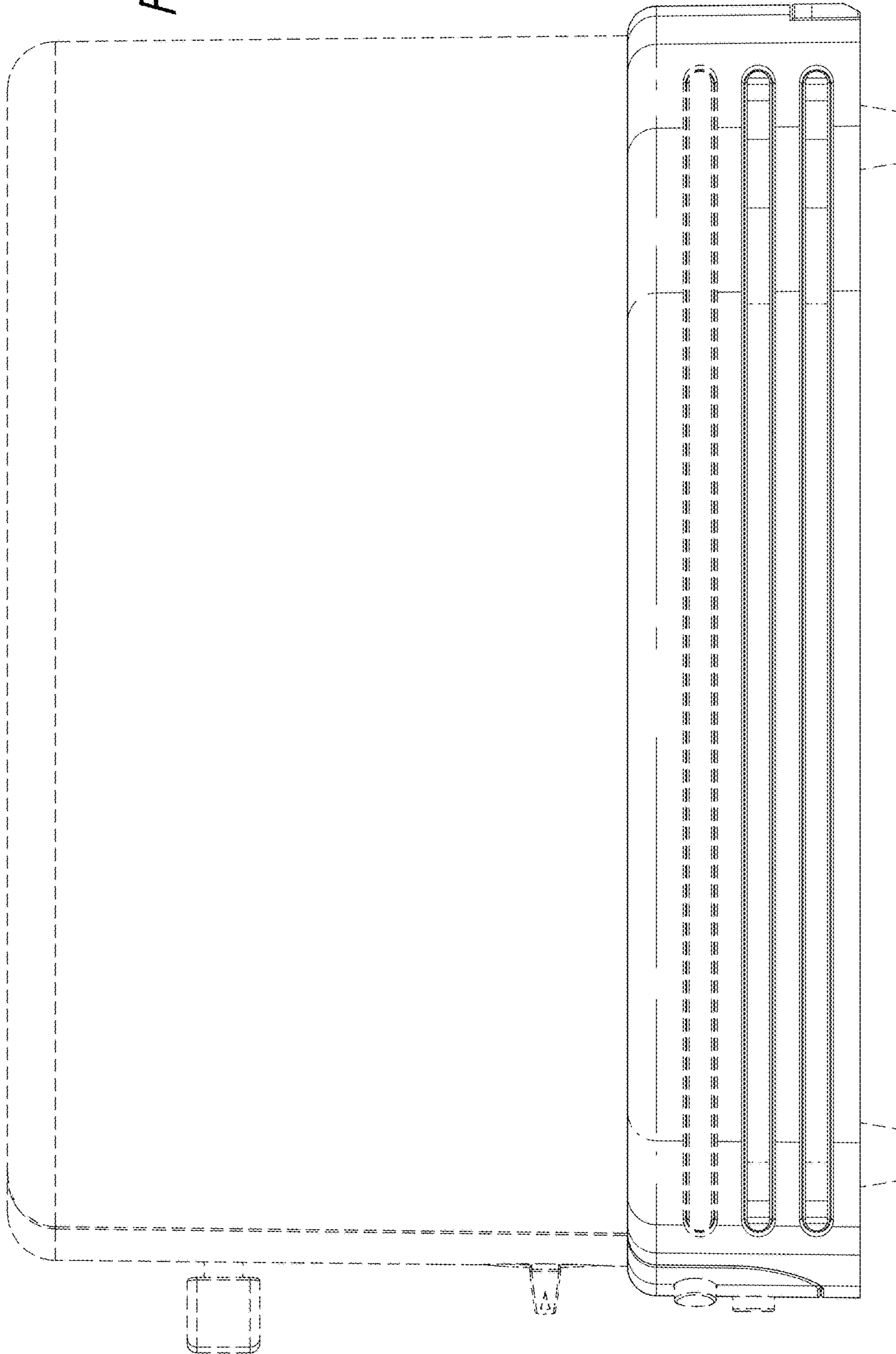
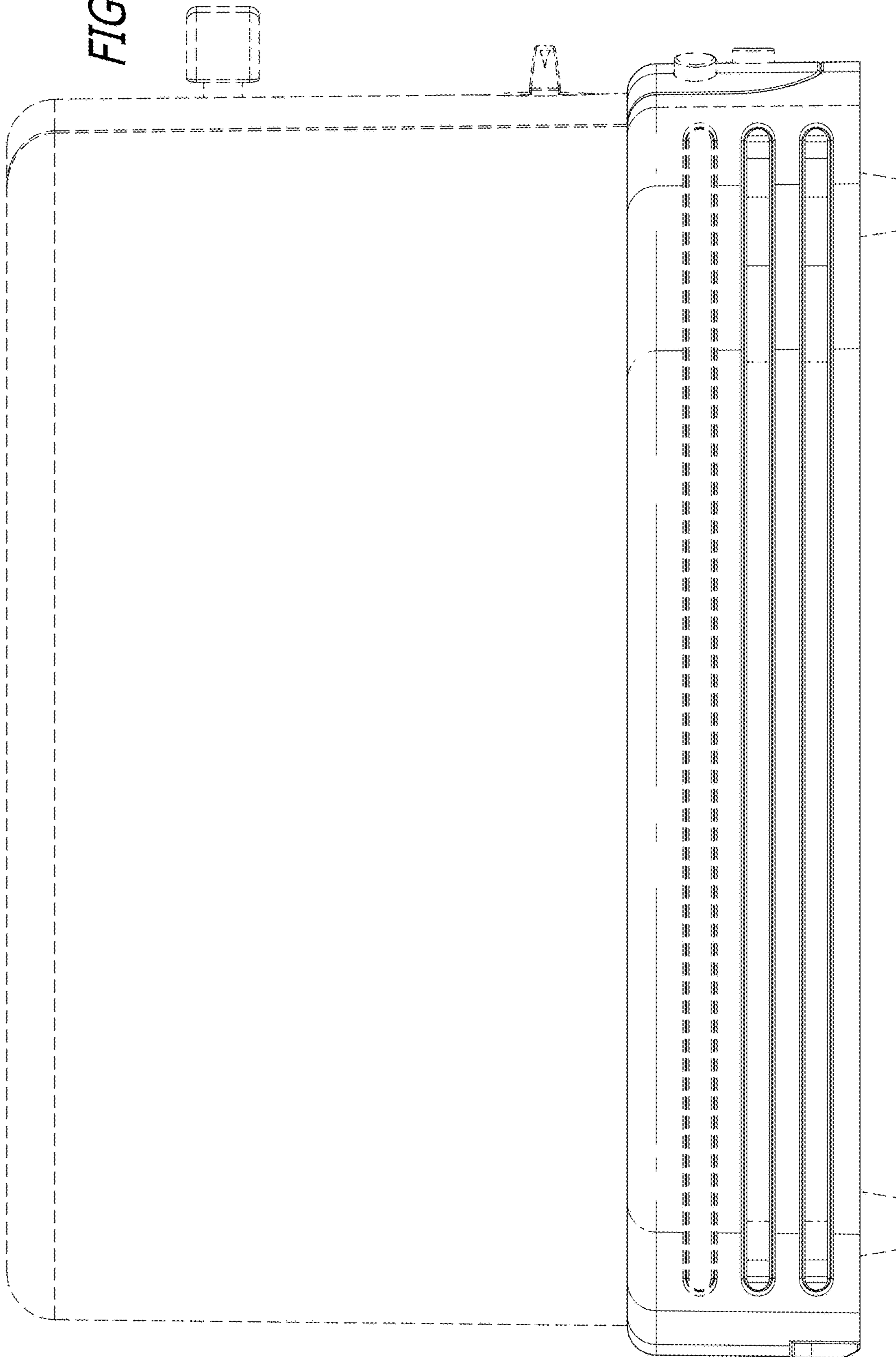

FIG. 10



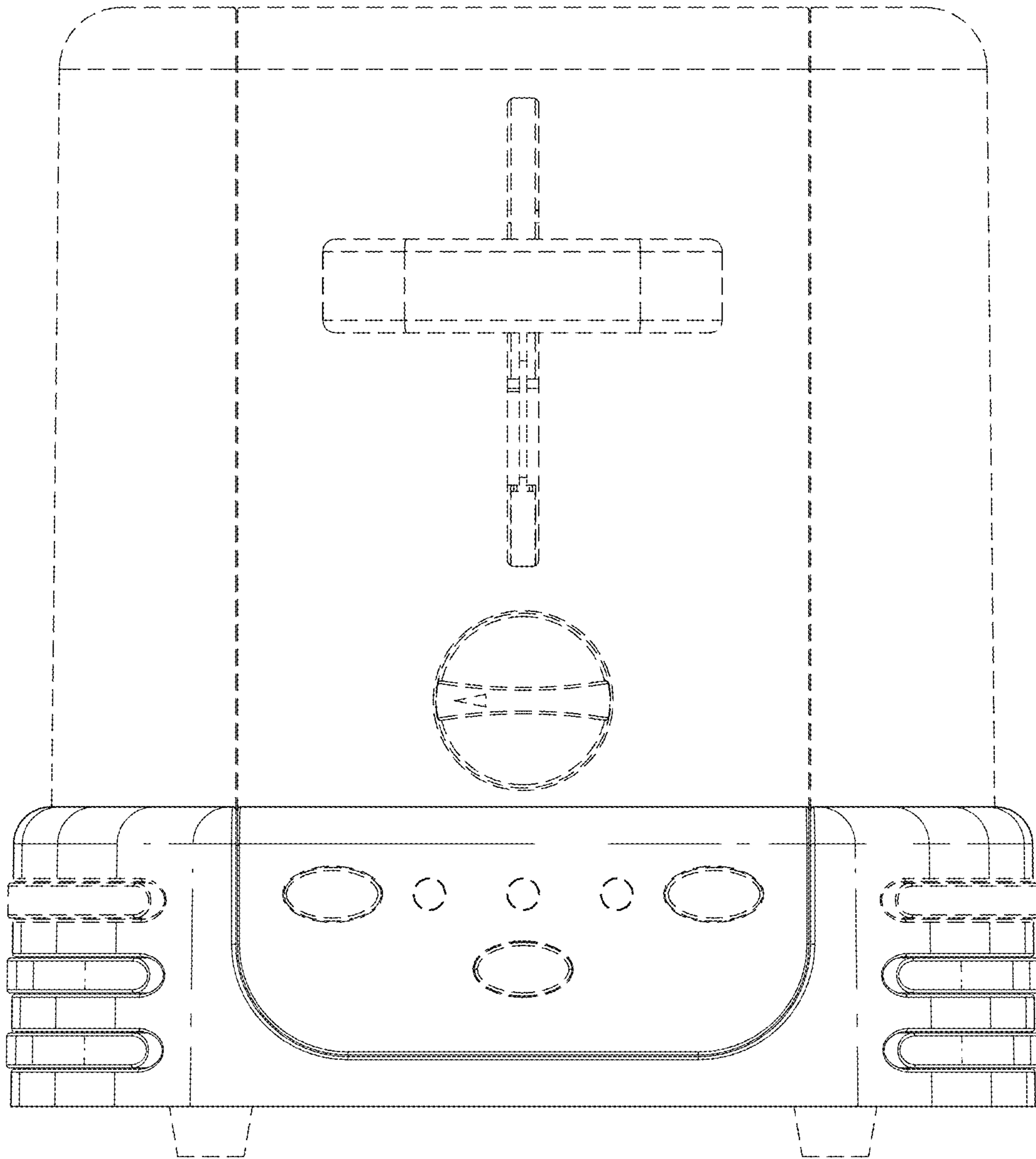

FIG. 11

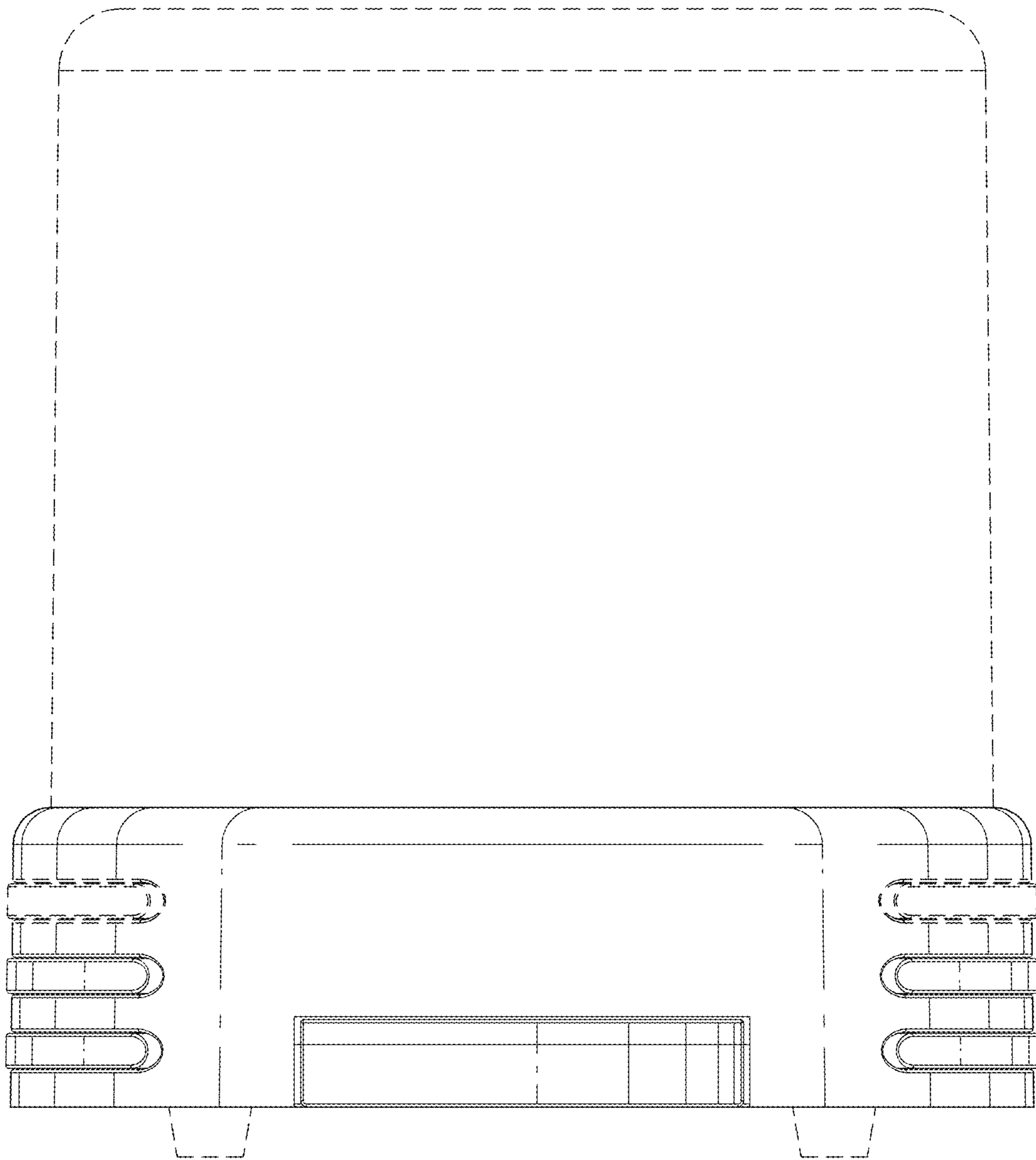

FIG. 12

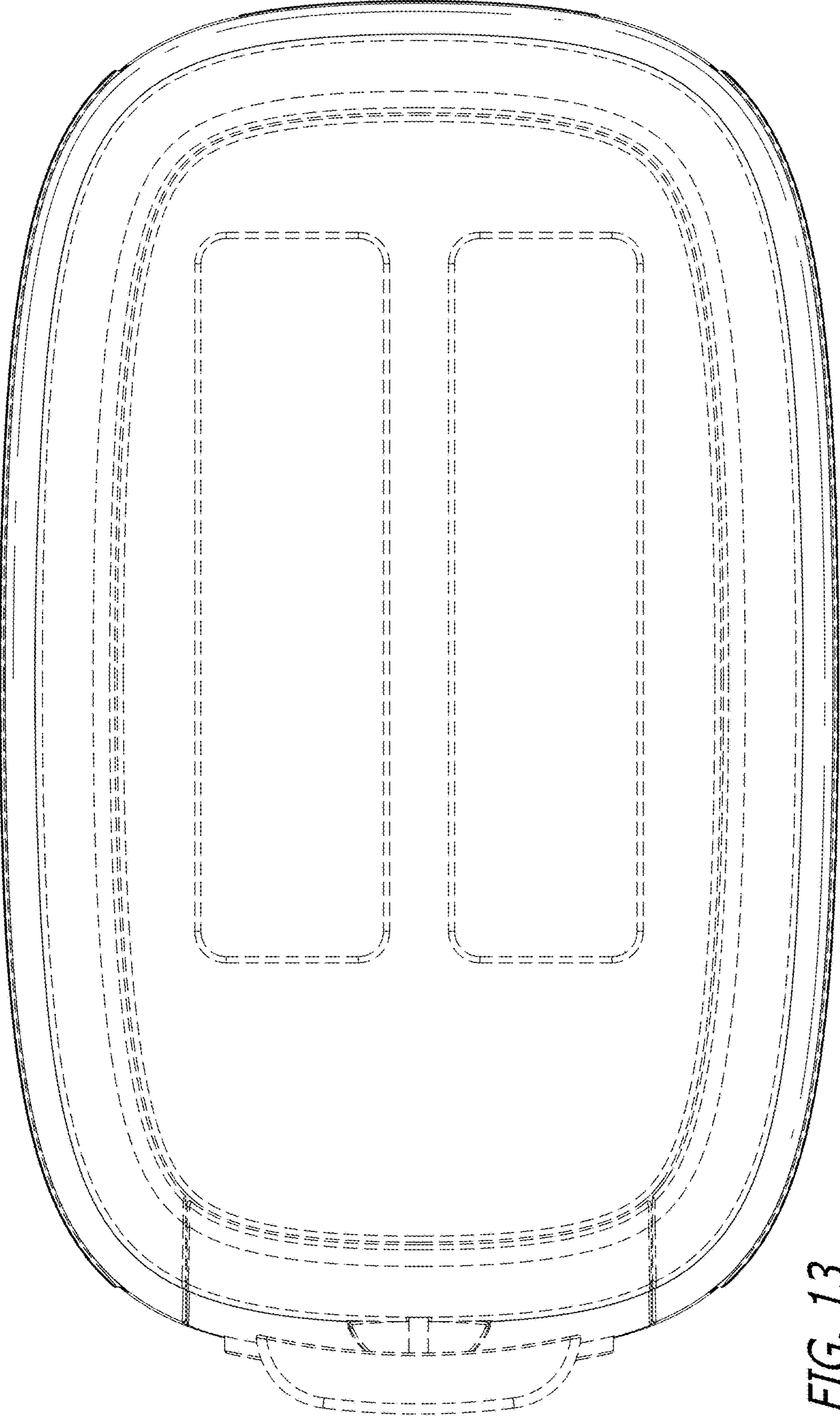

FIG. 13

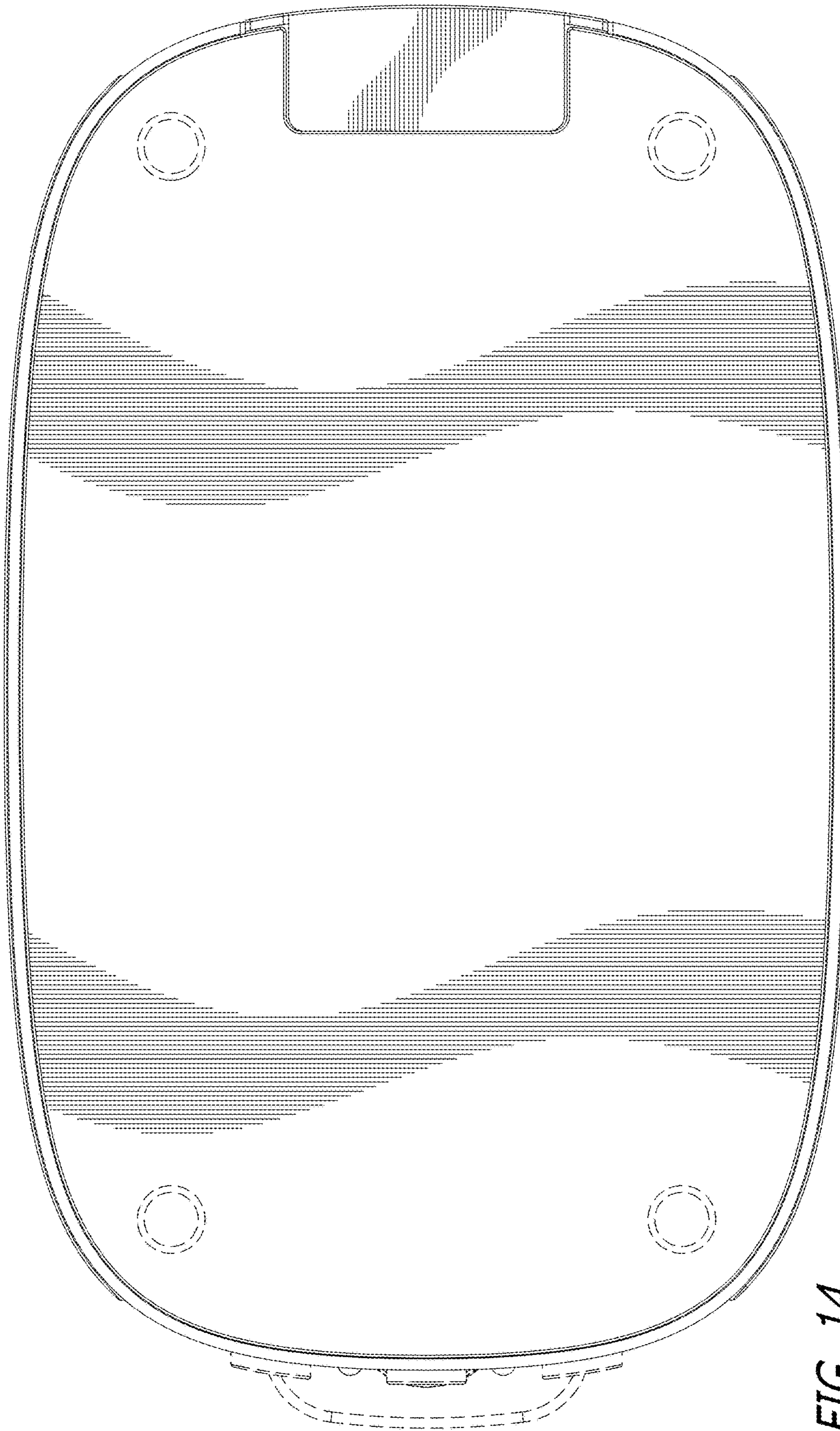
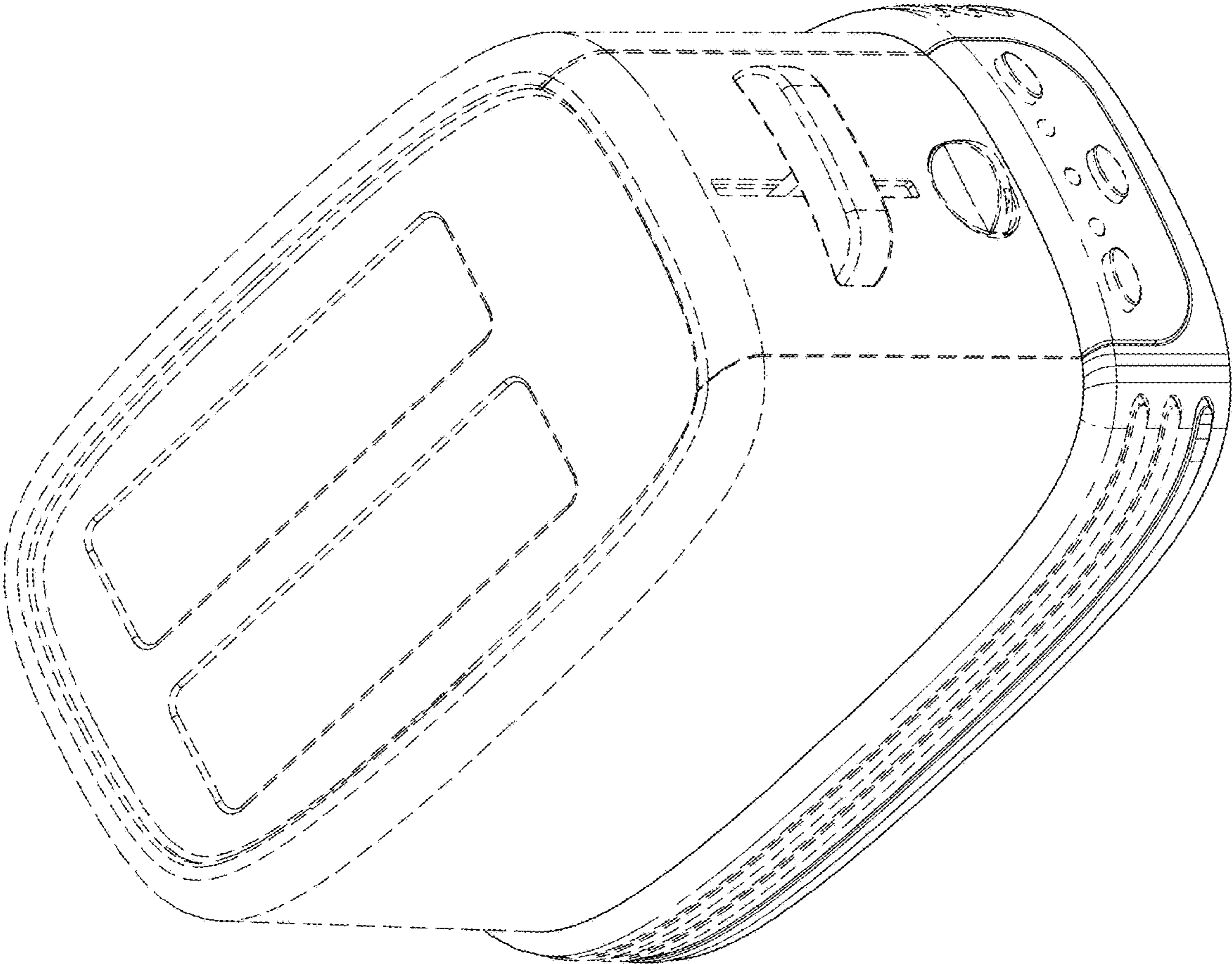

FIG. 14

FIG. 15



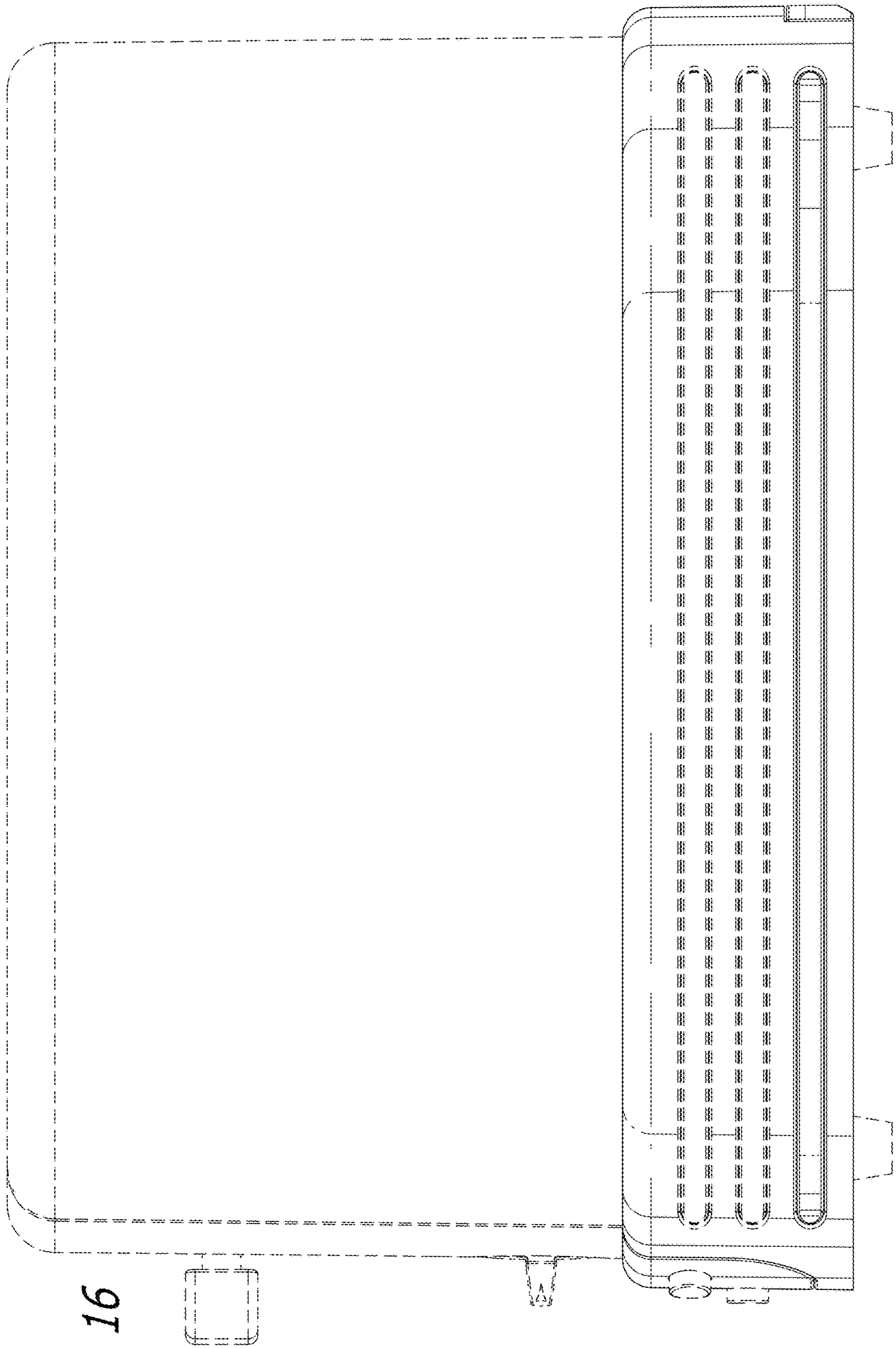
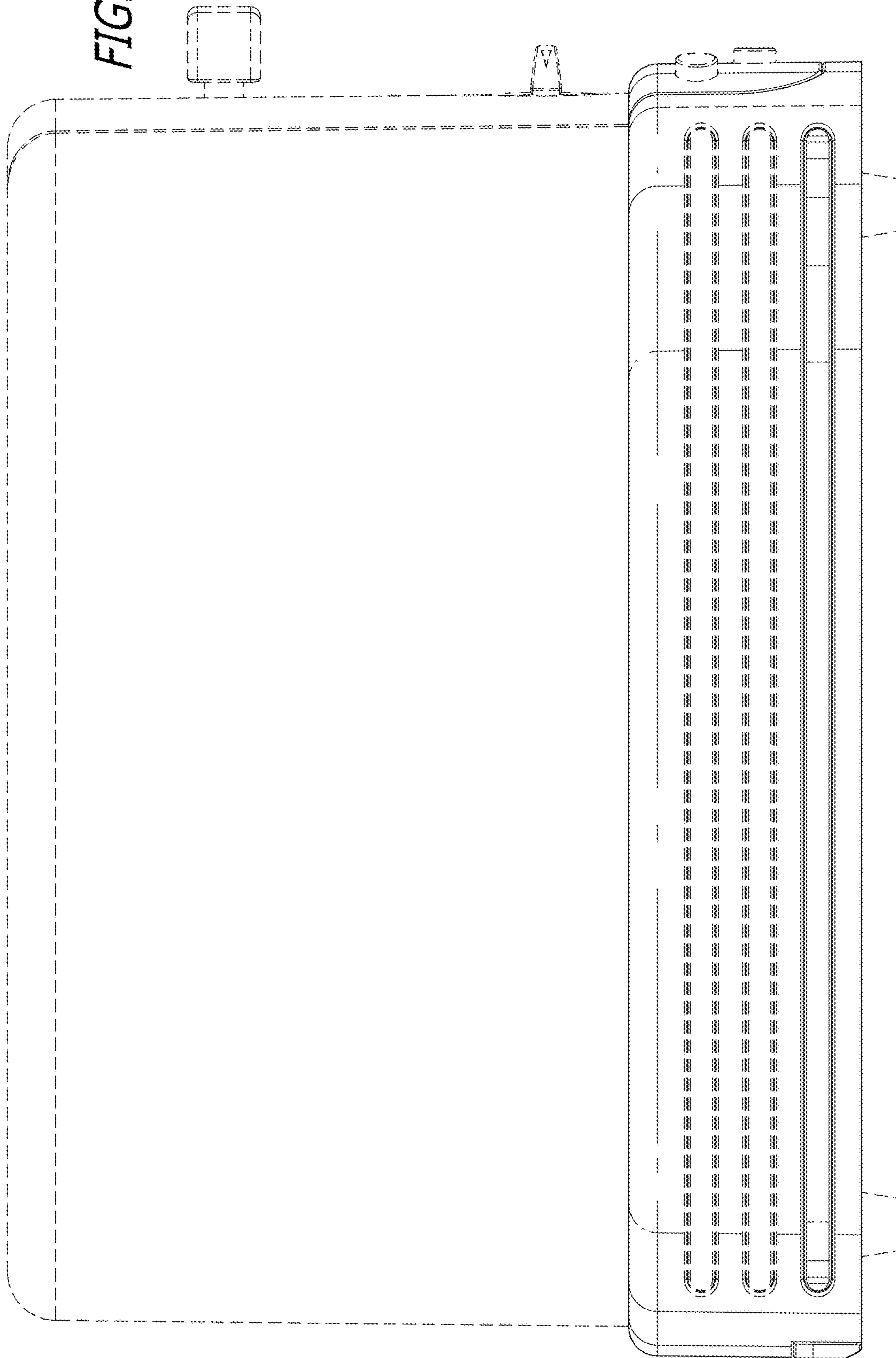

FIG. 16

FIG. 17



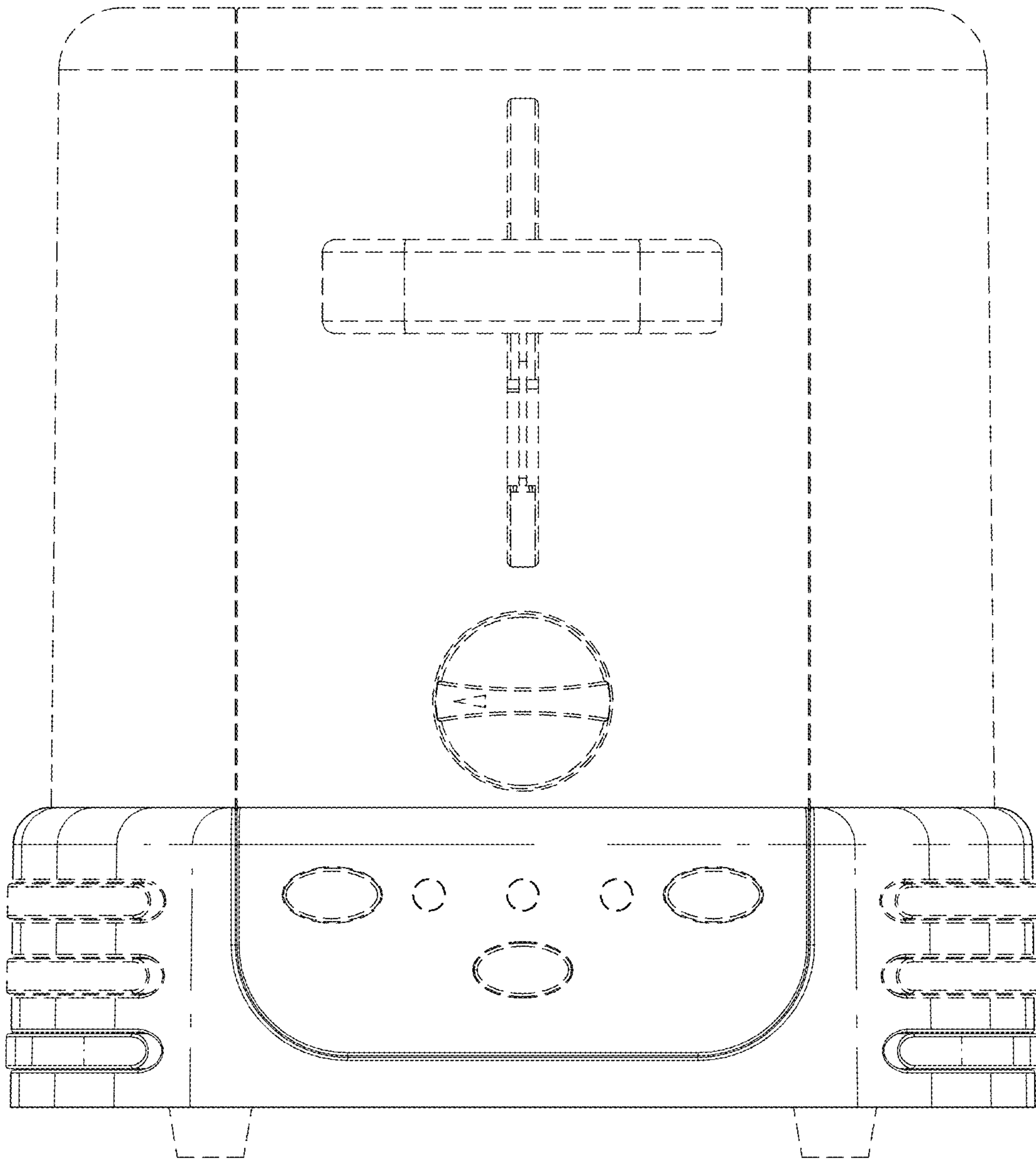

FIG. 18

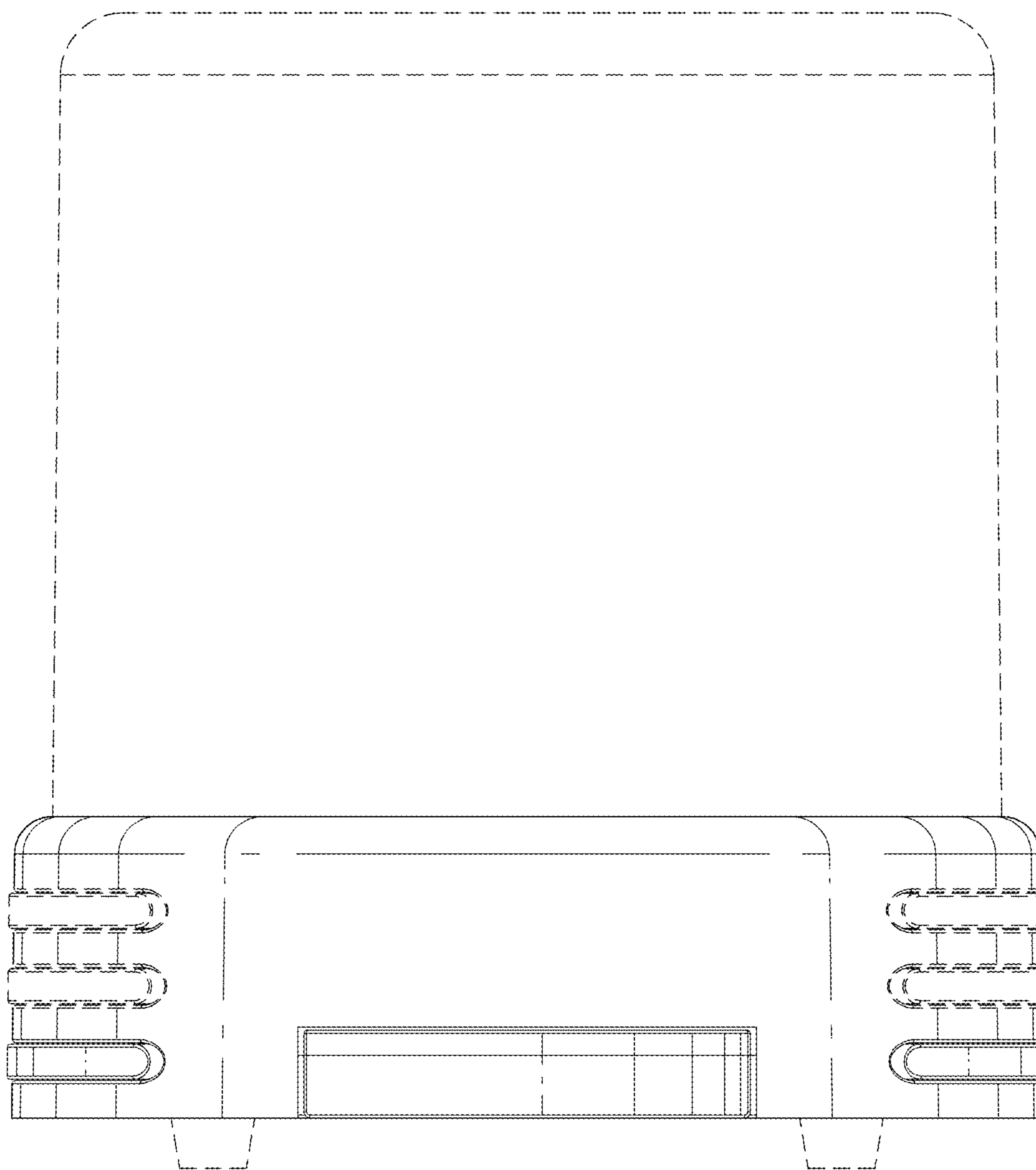

FIG. 19

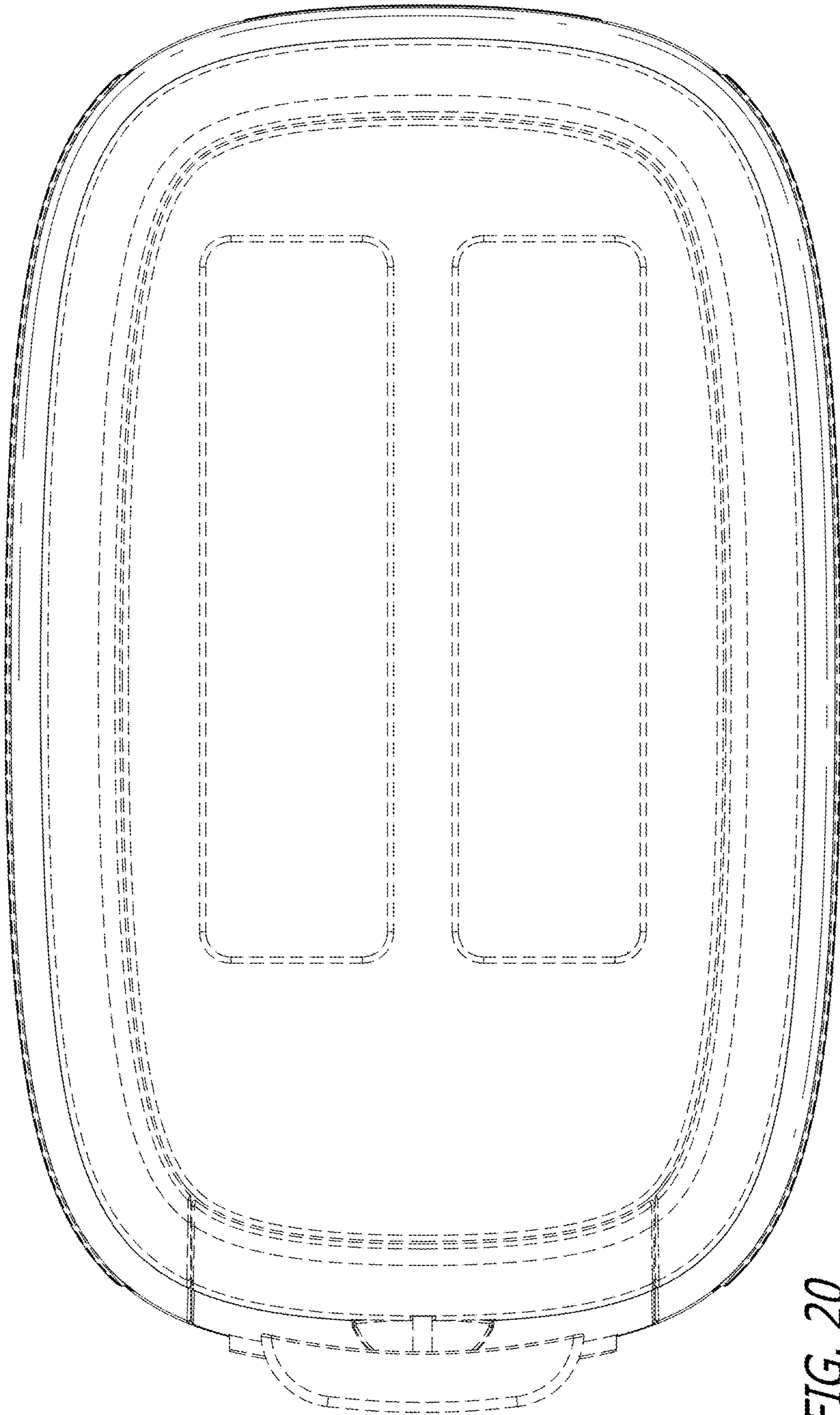

FIG. 20

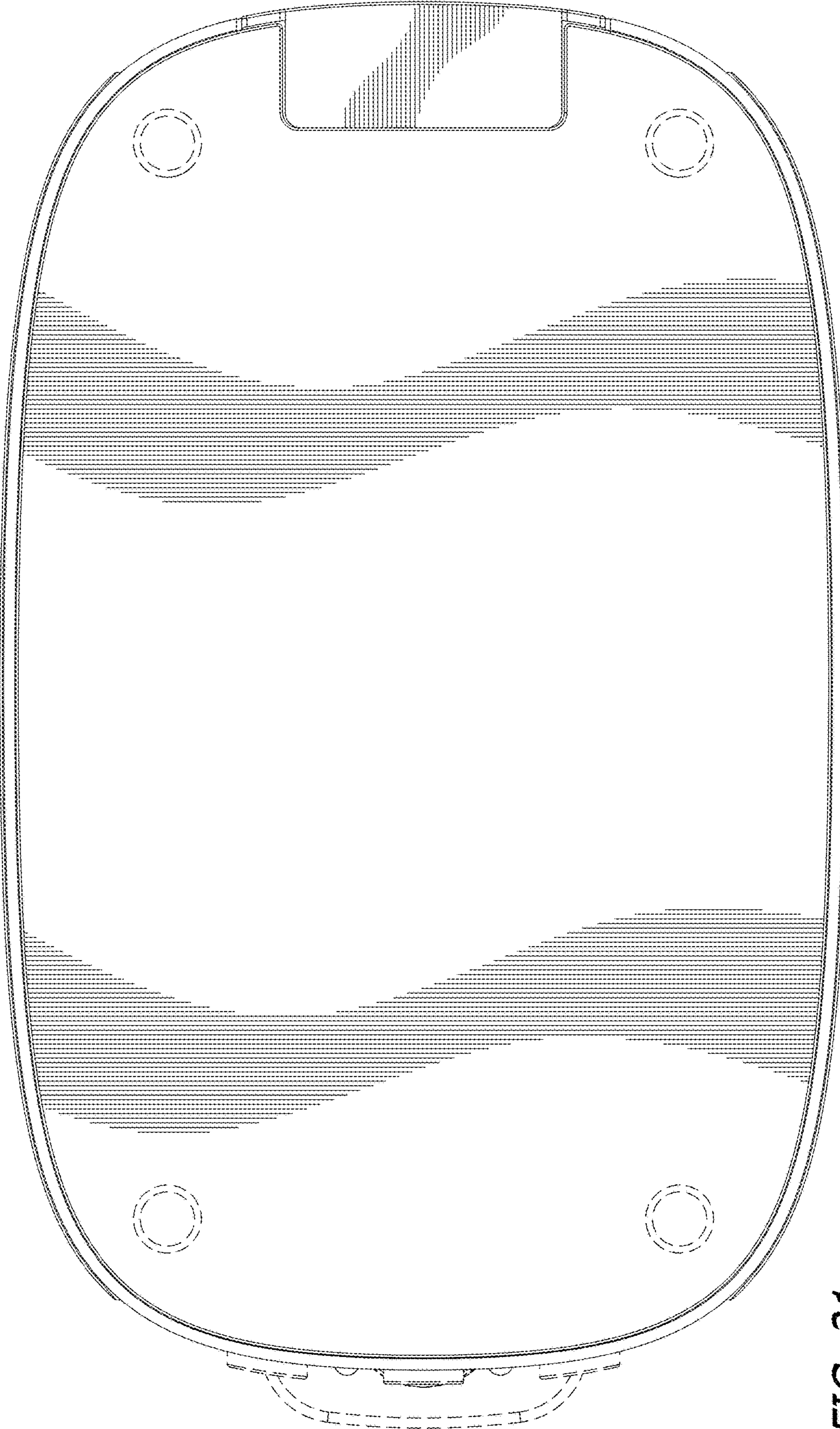

FIG. 21