



US00D794983S

(12) **United States Design Patent** (10) **Patent No.:** **US D794,983 S**  
**Peota et al.** (45) **Date of Patent:** **\*\* Aug. 22, 2017**

(54) **DISPLAY UNIT**

(71) Applicant: **Target Brands, Inc.**, Minneapolis, MN (US)

(72) Inventors: **Robert D. Peota**, Minneapolis, MN (US); **Robert P. Stoltz**, Edina, MN (US)

(73) Assignee: **Target Brands, Inc.**, Minneapolis, MN (US)

(\*\*) Term: **15 Years**

(21) Appl. No.: **29/559,622**

(22) Filed: **Mar. 30, 2016**

(51) **LOC (10) Cl.** ..... **20-02**

(52) **U.S. Cl.**  
USPC ..... **D6/675.1**

(58) **Field of Classification Search**  
USPC ..... D6/675-675.3; D19/91  
CPC ..... A47F 3/004; A47F 3/02  
See application file for complete search history.

(56) **References Cited**

**U.S. PATENT DOCUMENTS**

D153,909	S	*	5/1949	Wais	108/91
5,613,448	A	*	3/1997	Petty	A47B 7/02
					108/91
D401,790	S	*	12/1998	Buell	D6/687
D447,891	S	*	9/2001	Wood	D6/687
D686,438	S	*	7/2013	Denby	D6/687
D755,546	S	*	5/2016	Johnson	D6/675.3
D766,625	S	*	9/2016	Johnson	D6/675.3
D768,417	S	*	10/2016	Johnson	D6/687
D777,481	S	*	1/2017	Denby	D6/675.3

**OTHER PUBLICATIONS**

Design U.S. Appl. No. 29/515,778, filed Jan. 27, 2015, 9 pages.  
Design U.S. Appl. No. 29/515,782, filed Jan. 27, 2015, 10 pages.  
Design U.S. Appl. No. 29/526,339, filed May 8, 2015, 5 pages.

\* cited by examiner

*Primary Examiner* — John Windmuller

*Assistant Examiner* — Melvin L Davis

(74) *Attorney, Agent, or Firm* — Leanne Taveggia Farrell; Westman, Champlin & Koehler, P.A.

(57) **CLAIM**

The ornamental design for a display unit, as shown and described.

**DESCRIPTION**

FIG. 1 is a perspective view of a first embodiment of a display unit showing our new design;  
FIG. 2 is a front view thereof;  
FIG. 3 is a back view thereof;  
FIG. 4 is a right side view thereof;  
FIG. 5 is a left side view thereof;  
FIG. 6 is a top view thereof;  
FIG. 7 is a perspective view of a second embodiment thereof;  
FIG. 8 is a front view of FIG. 7;  
FIG. 9 is a back view of FIG. 7;  
FIG. 10 is a right side view of FIG. 7;  
FIG. 11 is a left side view of FIG. 7; and,  
FIG. 12 is a top view of FIG. 7.

The broken lines shown in the drawings are included for purposes of illustrating portions of the display unit and form no part of the claimed design.

**1 Claim, 10 Drawing Sheets**

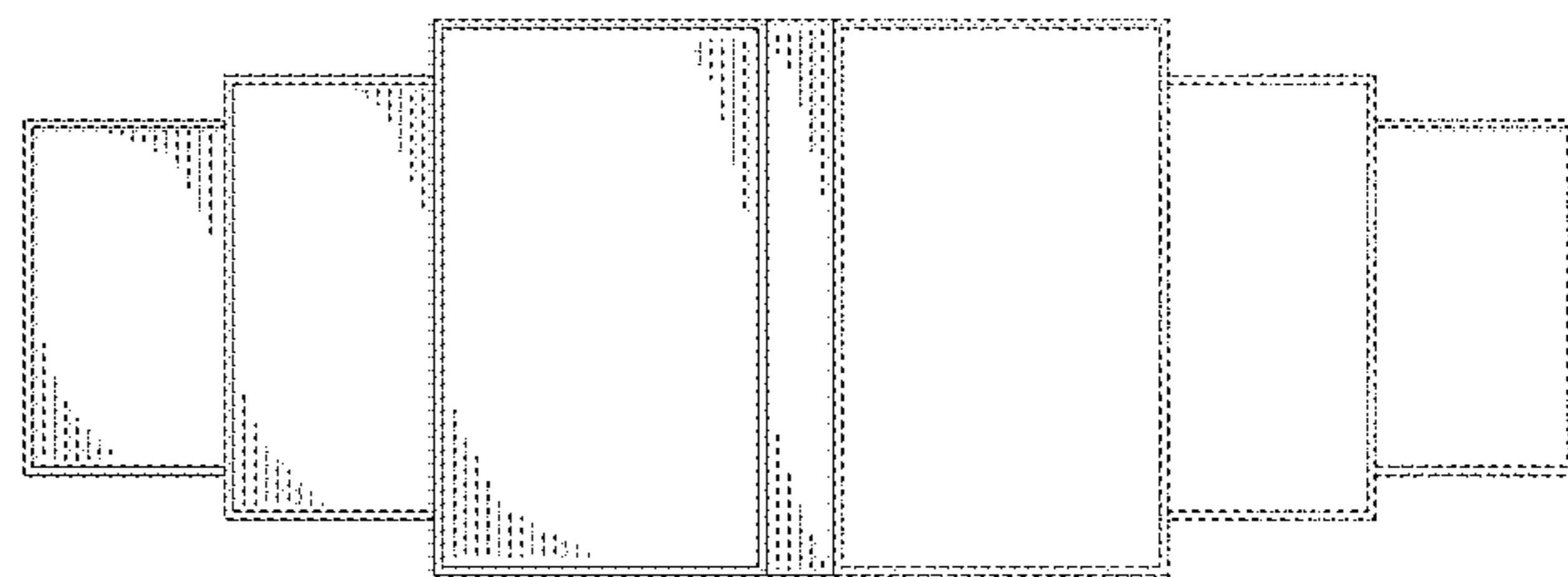
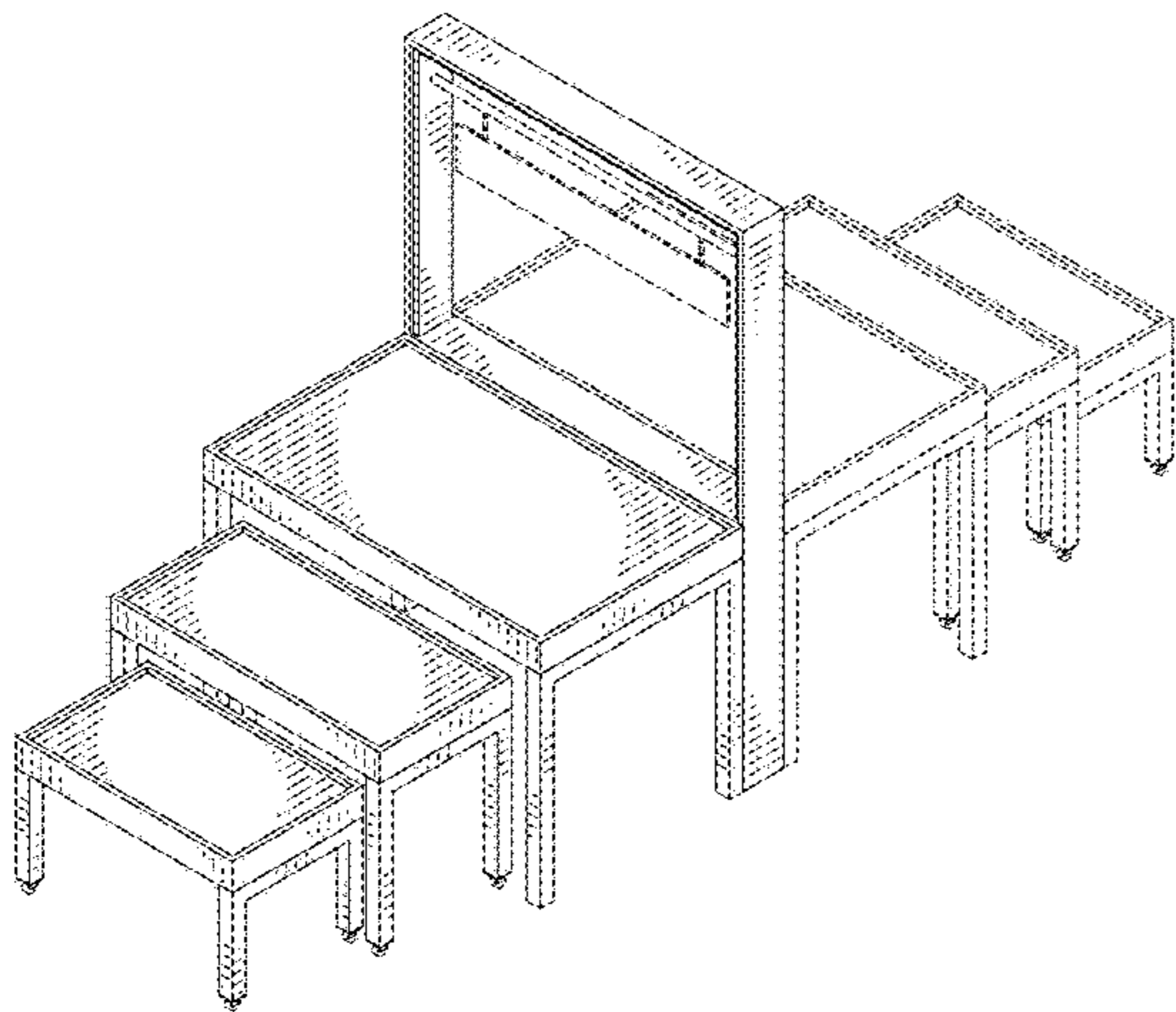

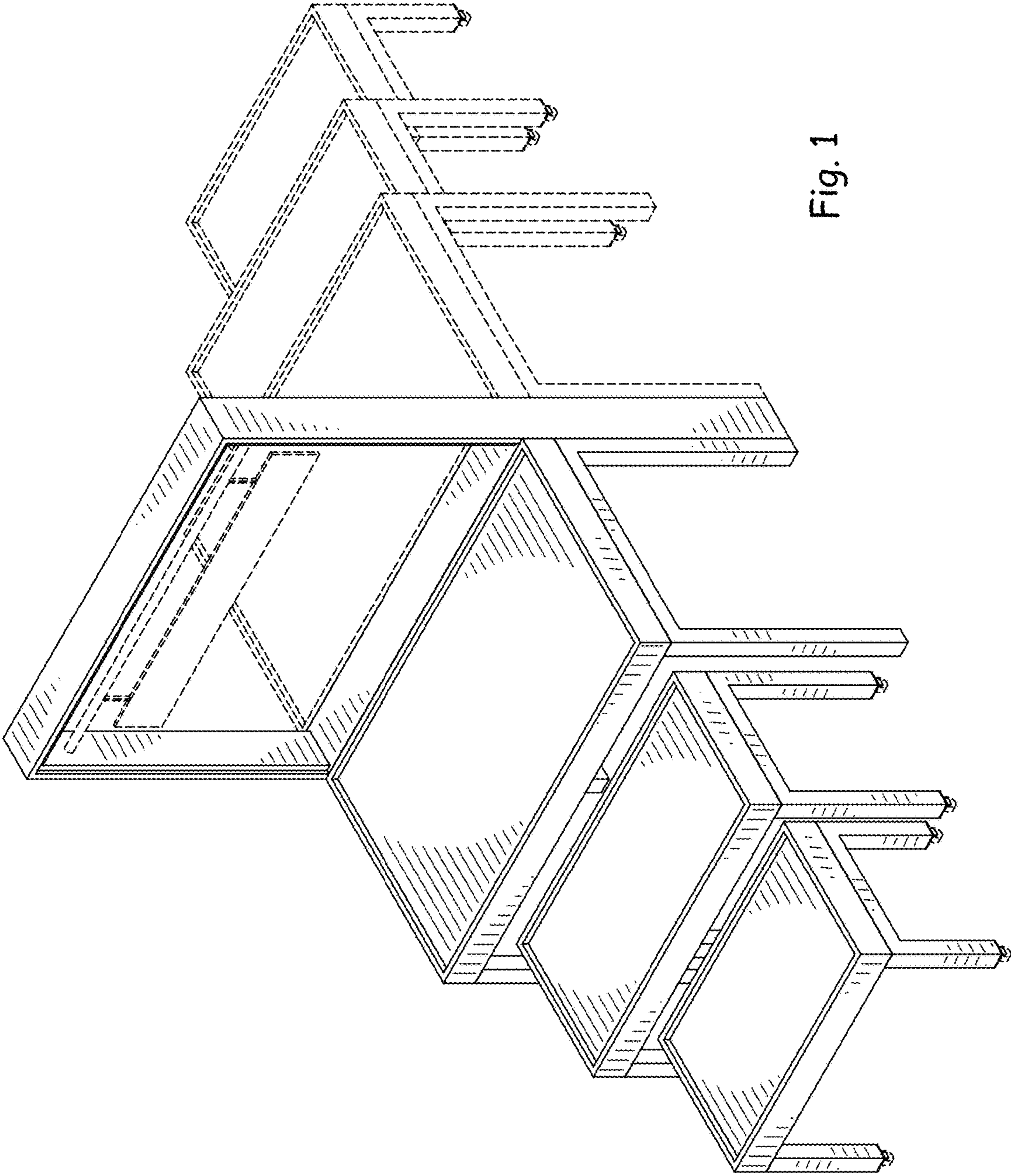

Fig. 1

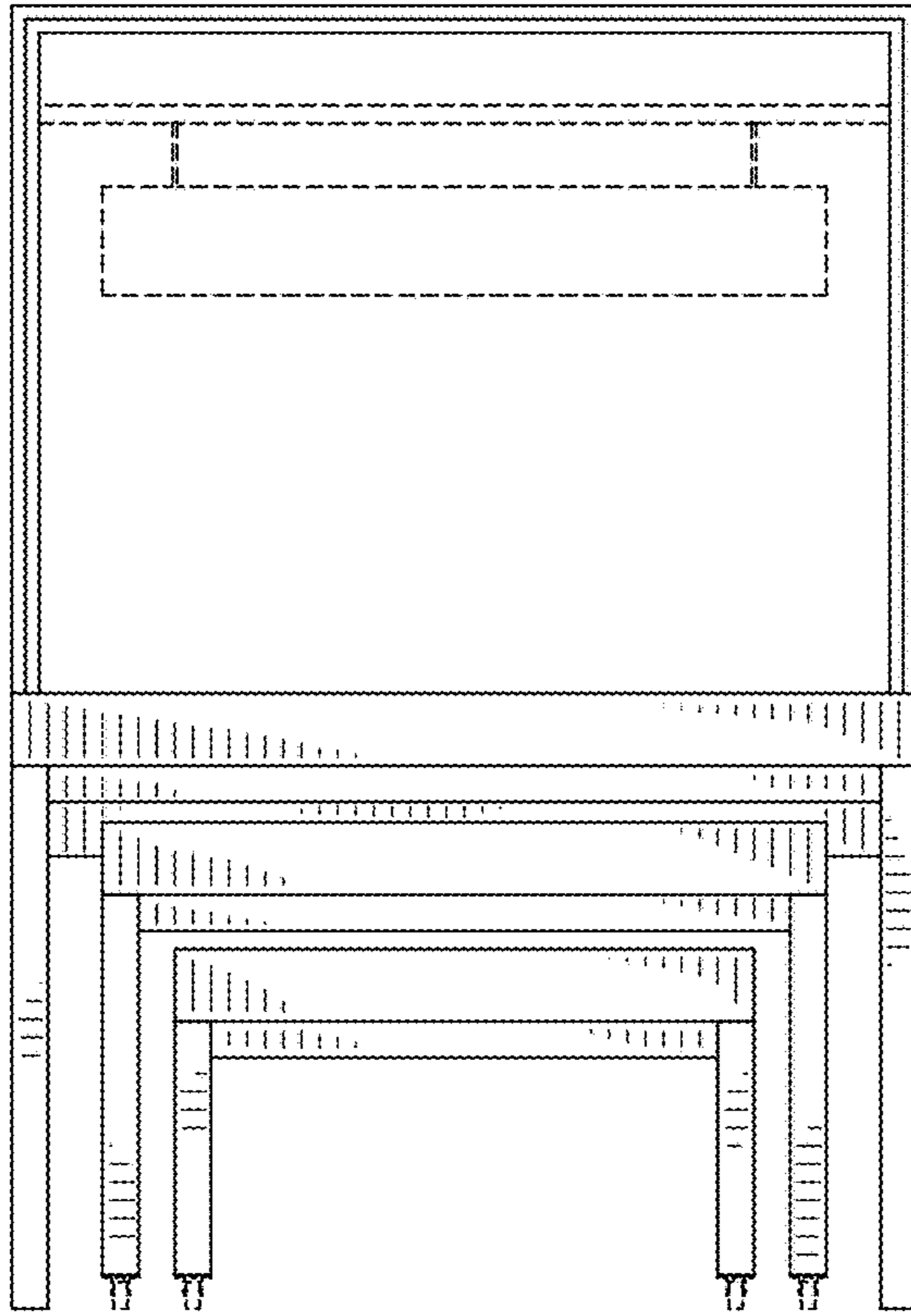

Fig. 2

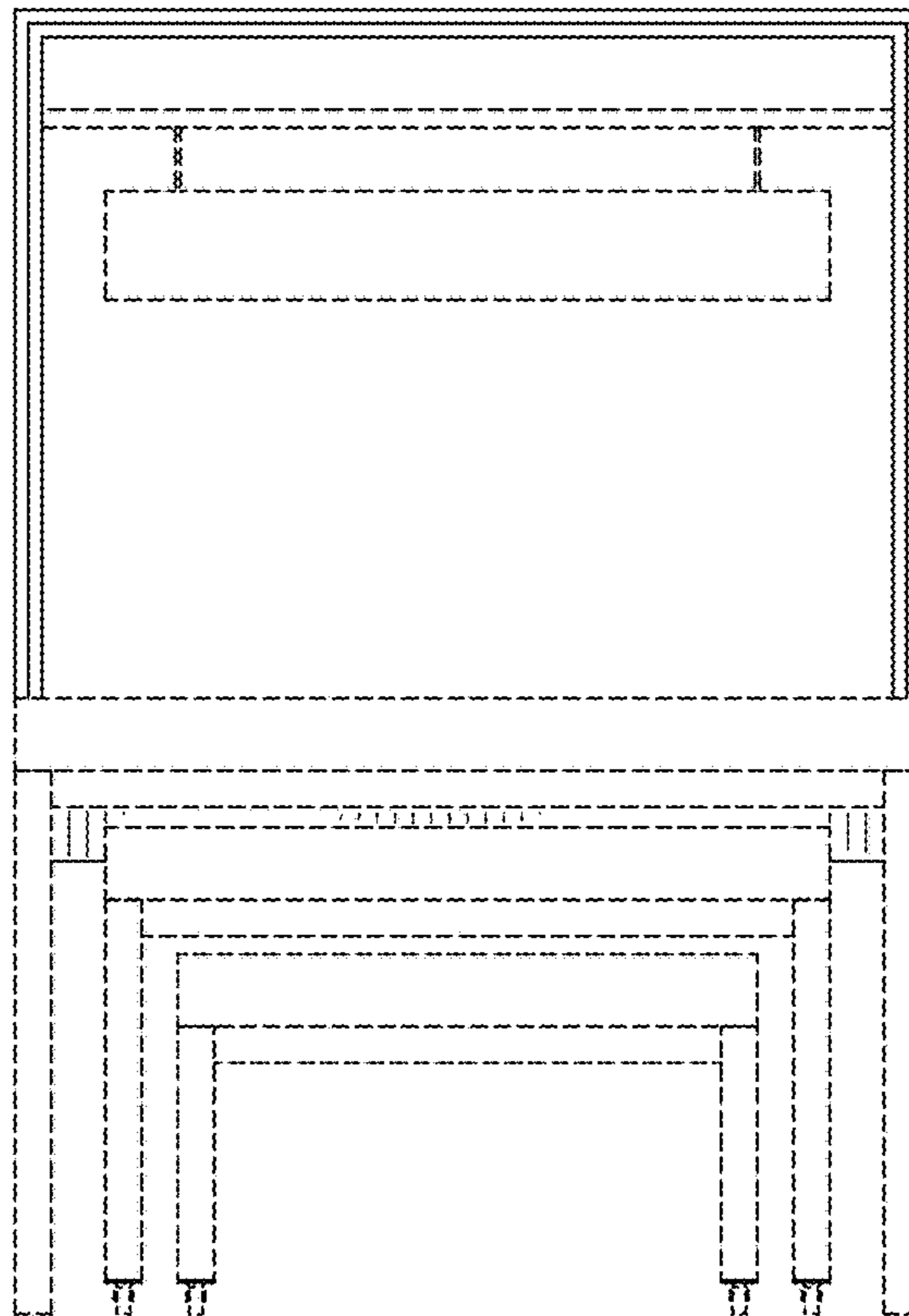

Fig. 3

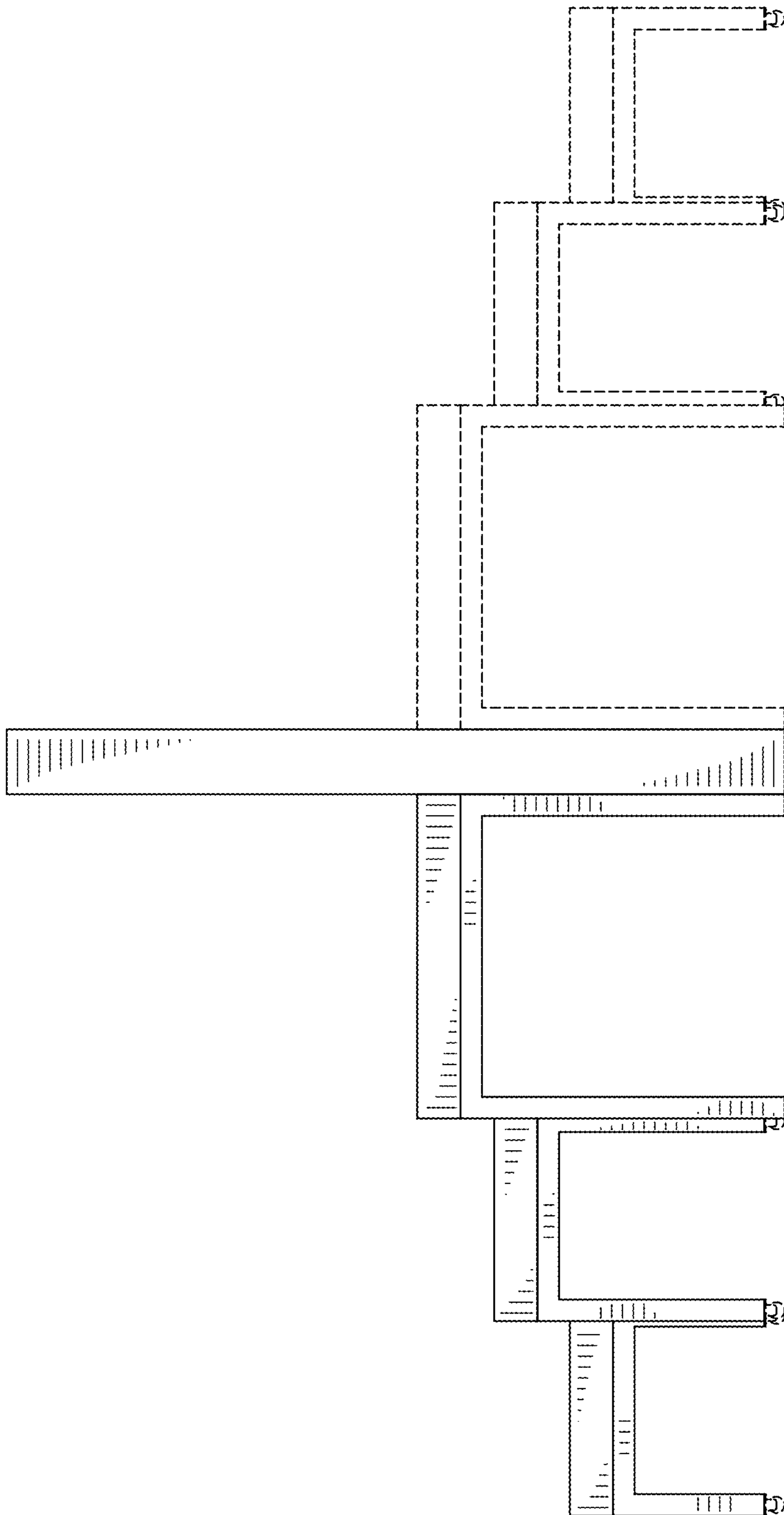

Fig. 4

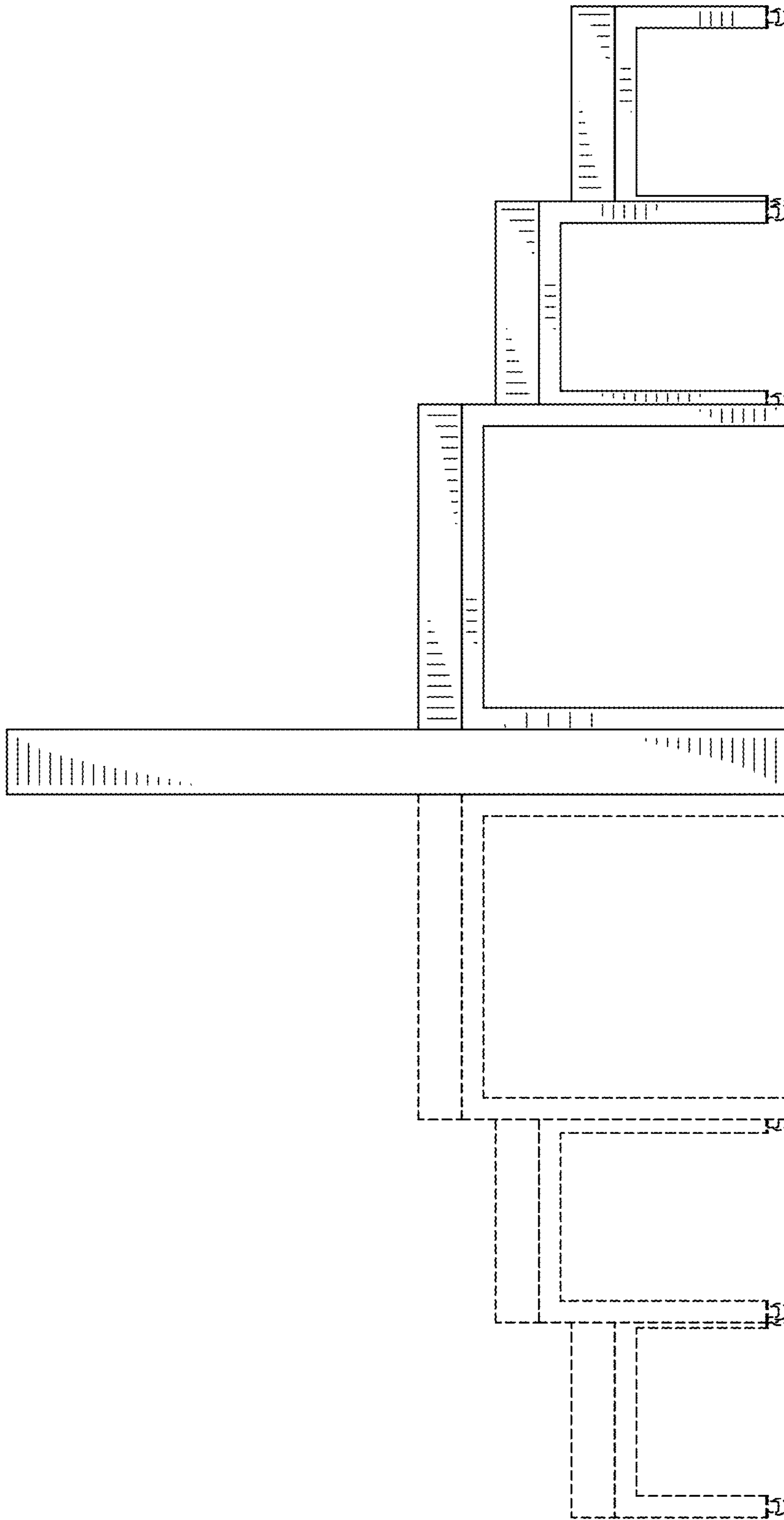

Fig. 5

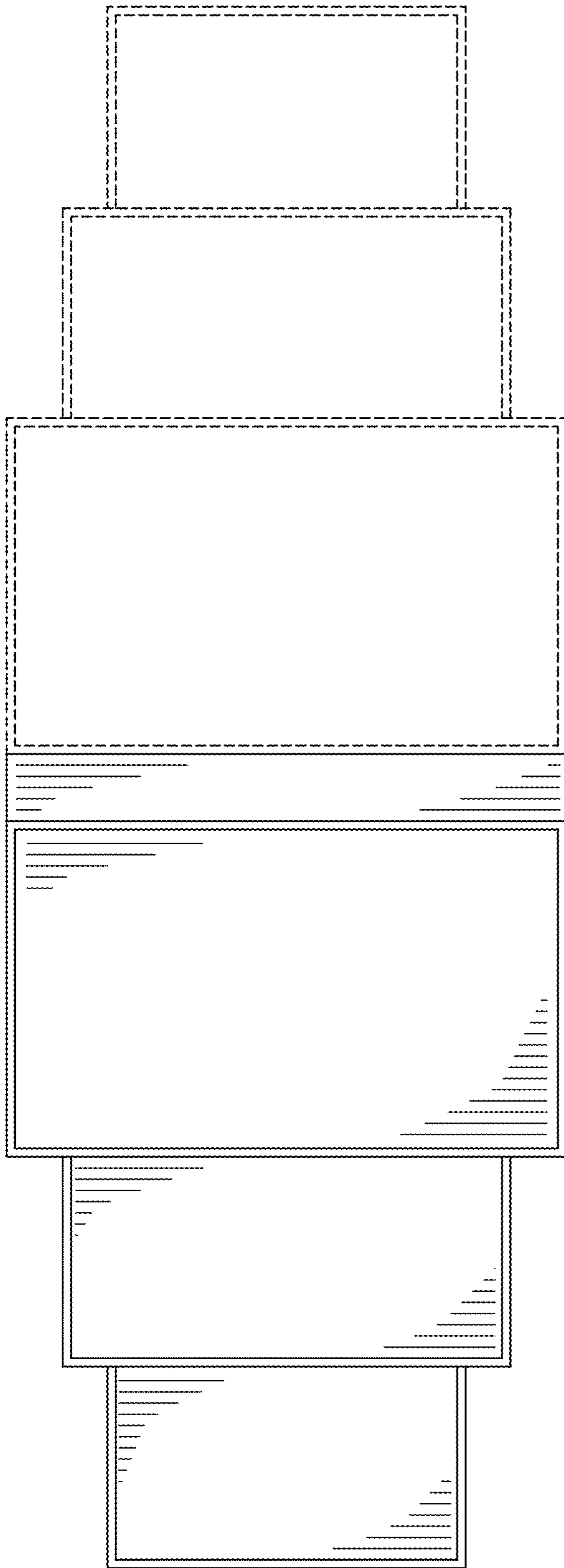

Fig. 6

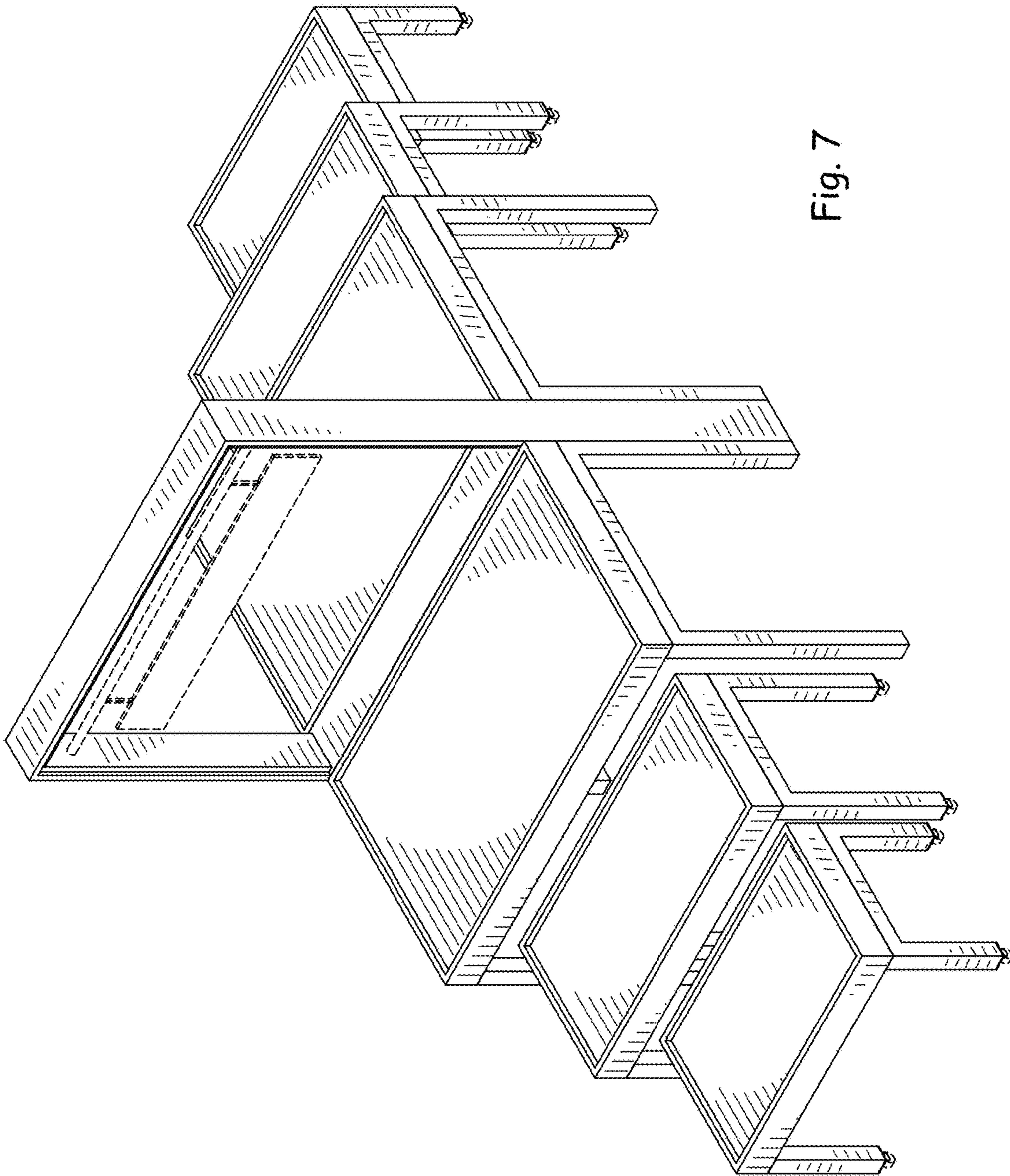

Fig. 7

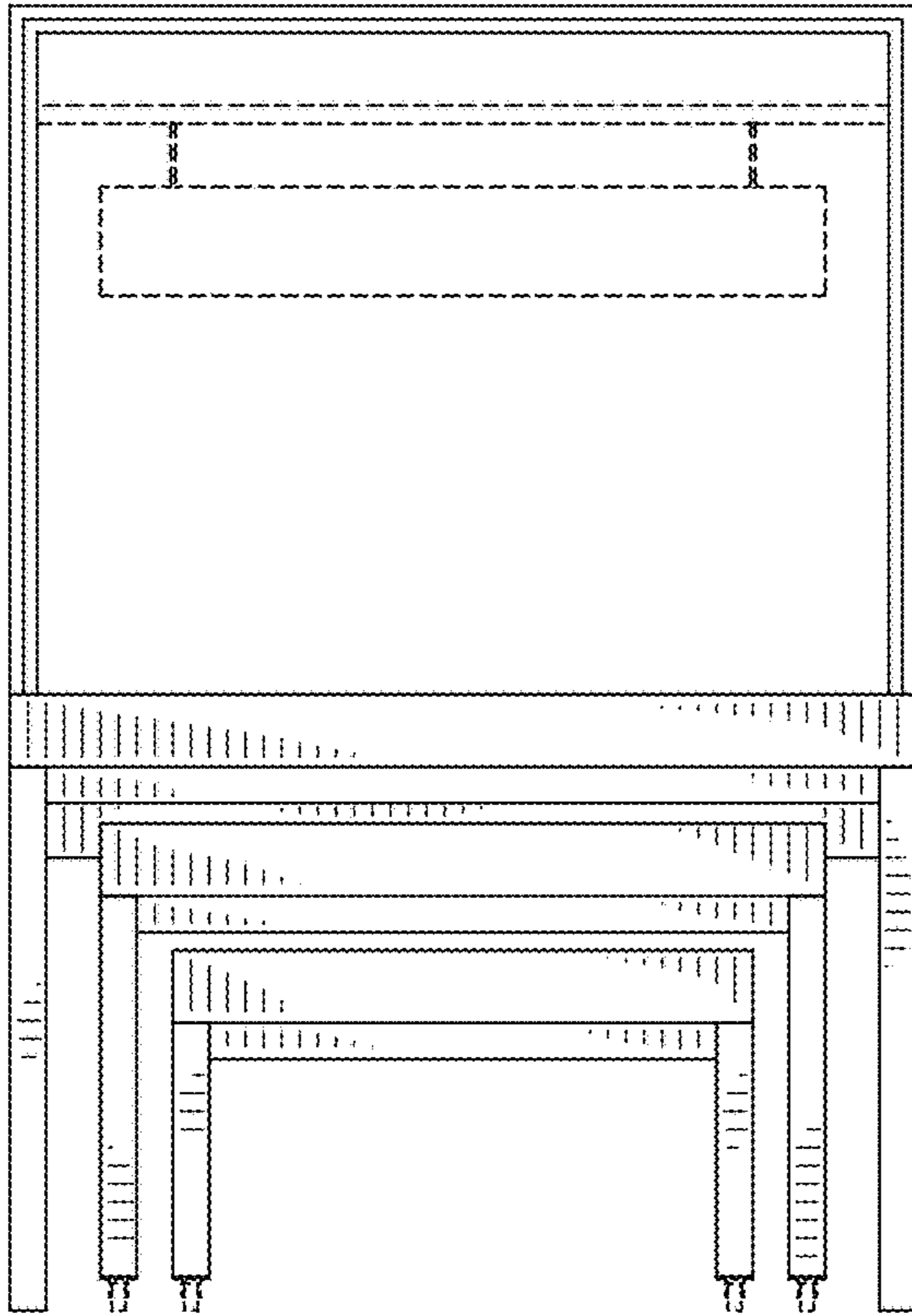

Fig. 8

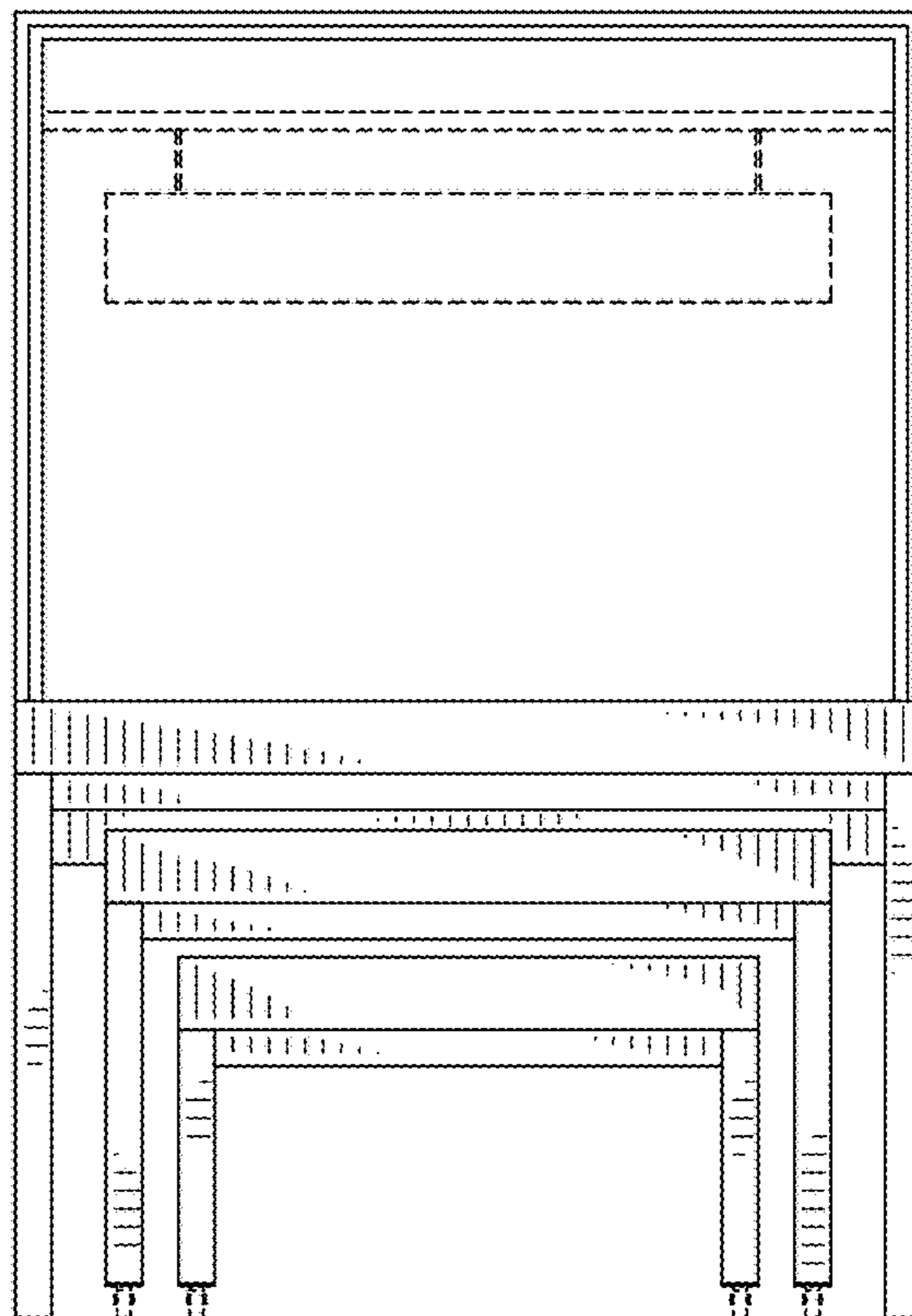

Fig. 9



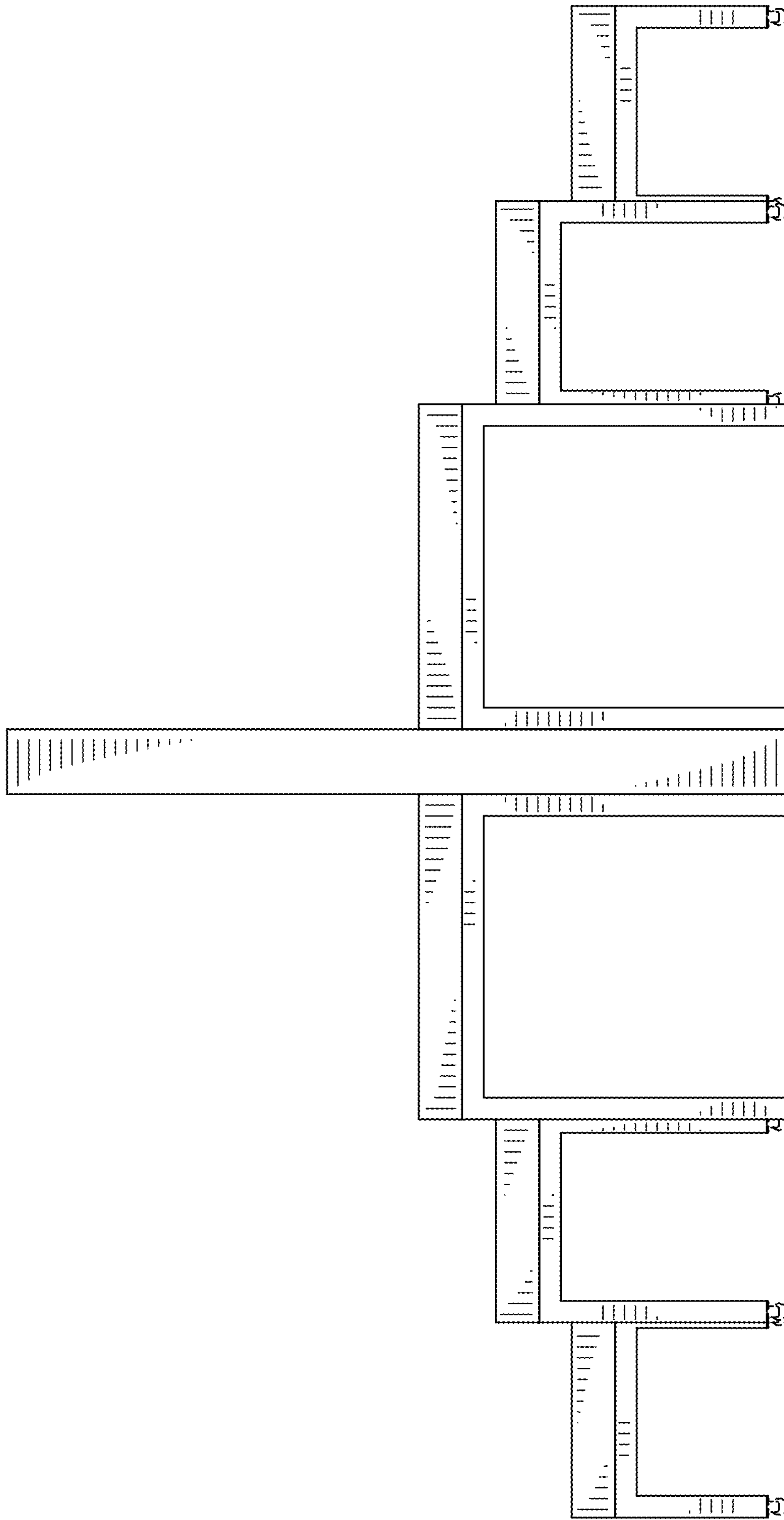

Fig. 10

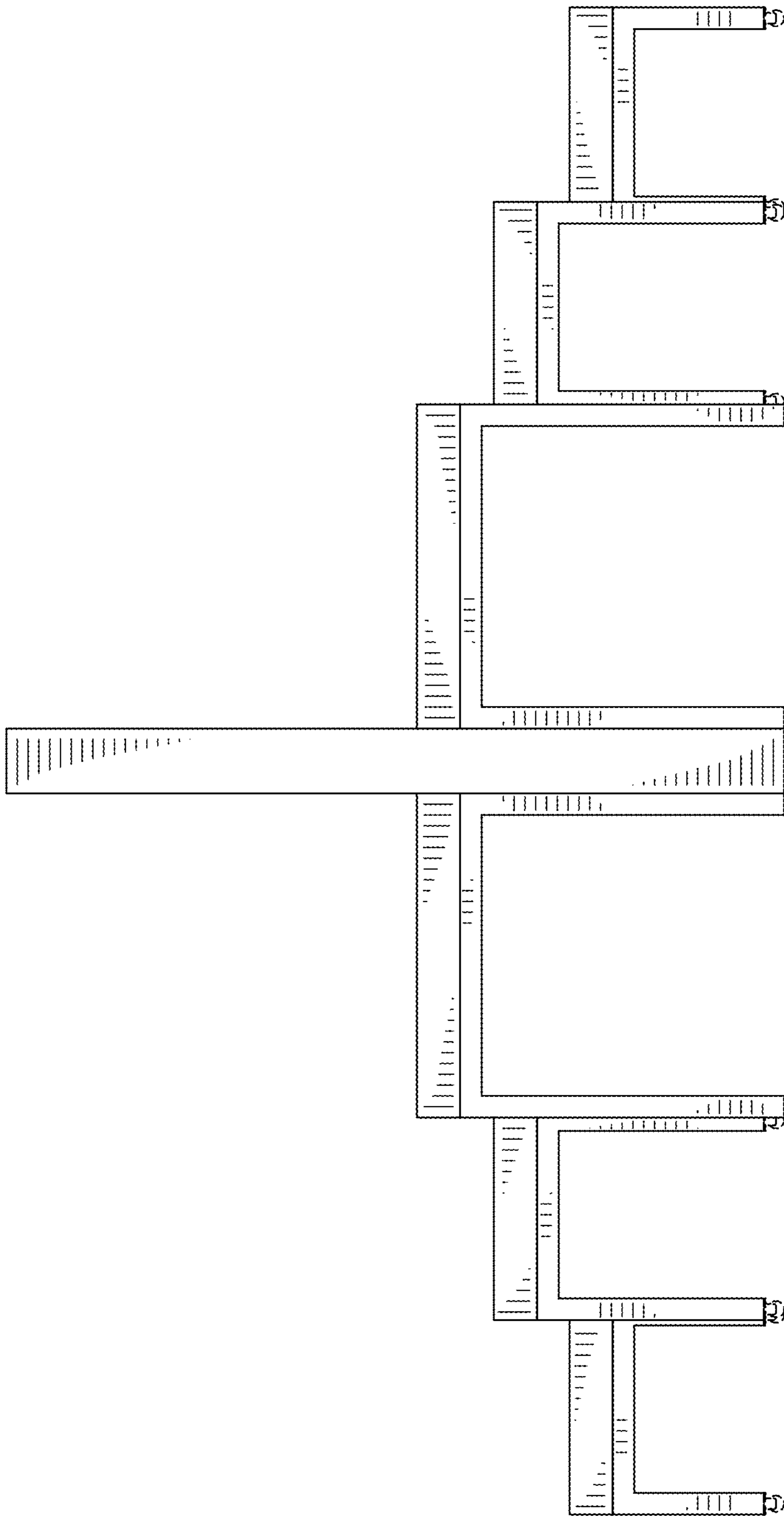

Fig. 11

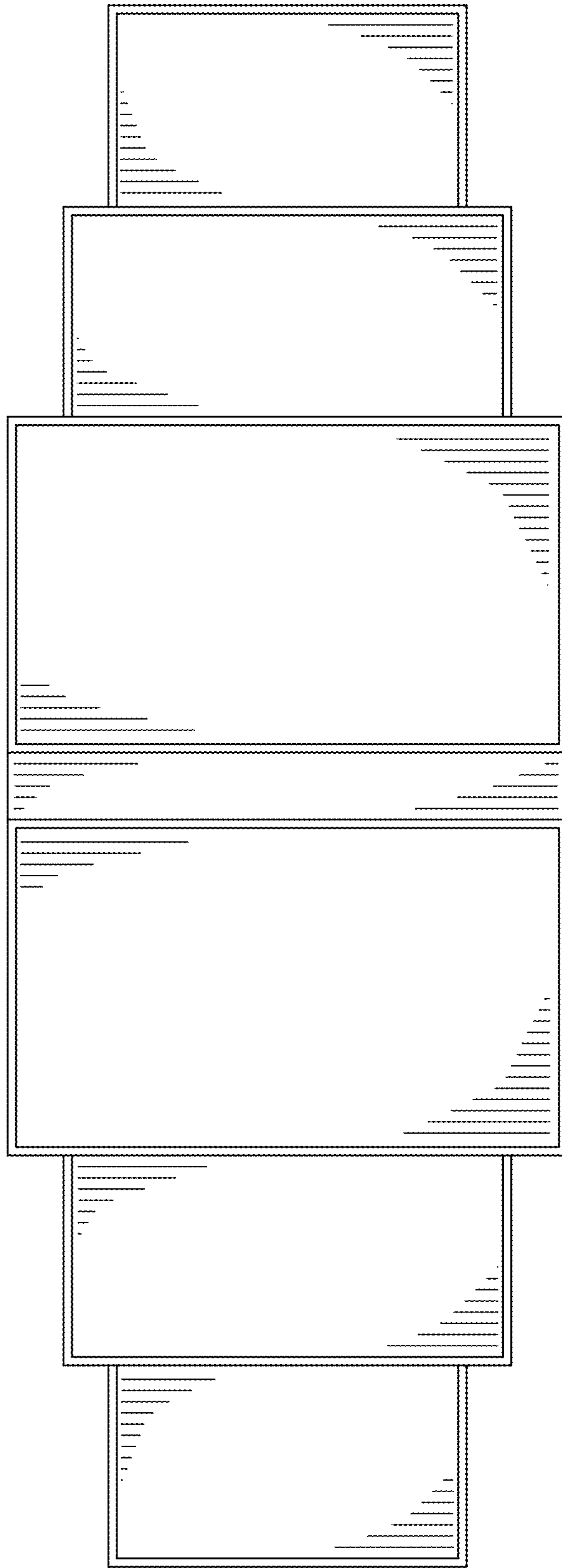

Fig. 12