



US00D794981S

(12) **United States Design Patent** (10) **Patent No.:** **US D794,981 S**
Roma et al. (45) **Date of Patent:** **** Aug. 22, 2017**

(54) **REMOVABLE MATTRESS COVER**

(71) Applicants: **John K. Roma**, Orchard Park, NY
(US); **Valerie Roma**, Orchard Park, NY
(US)

(72) Inventors: **John K. Roma**, Orchard Park, NY
(US); **Valerie Roma**, Orchard Park, NY
(US)

(**) Term: **15 Years**

(21) Appl. No.: **29/531,562**

(22) Filed: **Jun. 26, 2015**

(51) **LOC (10) Cl.** **06-09**

(52) **U.S. Cl.**
USPC **D6/596**

(58) **Field of Classification Search**
USPC D6/582-583, 587-592, 595-609,
D6/617-622; D21/803-809; D24/183
(Continued)

(56) **References Cited**

U.S. PATENT DOCUMENTS

2,400,731 A * 5/1946 Armstrong A47C 27/006
150/154
3,020,566 A * 2/1962 Anderson A47G 9/0246
5/496

(Continued)

Primary Examiner — Mary Ann Calabrese

Assistant Examiner — Jennifer L Rempfer

(74) *Attorney, Agent, or Firm* — Hodgson Russ LLP

(57) **CLAIM**

The ornamental design for a removable mattress cover, as shown and described.

DESCRIPTION

FIG. 1 is a front-left perspective view of a first embodiment removable mattress cover showing my new design, the rear-right perspective view being mirror-symmetrical thereto;

FIG. 2 is a left side view thereof;
FIG. 3 is a right side view thereof;
FIG. 4 is a front view thereof;
FIG. 5 is a rear view thereof;
FIG. 6 is a bottom view thereof;
FIG. 7 is a top view thereof;
FIG. 8 is an exploded perspective view showing the upper and lower portions of the removable mattress cover removed from exemplary internal components of a mattress, the opposite perspective view being mirror symmetrical thereto;
FIG. 9 is a detail view of a corner portion of the removable mattress cover being opened, the remaining three corners being symmetrical thereto;
FIG. 10 is a front-left perspective view of a second embodiment removable mattress cover showing my new design, the rear-right perspective view being mirror-symmetrical thereto;
FIG. 11 is a left side view thereof;
FIG. 12 is a right side view thereof;
FIG. 13 is a front view thereof;
FIG. 14 is a rear view thereof;
FIG. 15 is a bottom view thereof;
FIG. 16 is a top view thereof;
FIG. 17 is an exploded perspective view showing the upper and lower portions of the removable mattress cover removed from exemplary internal components of a mattress, the opposite perspective view being mirror symmetrical thereto; and,
FIG. 18 is a detail view of a corner portion of the removable mattress cover being opened, the remaining three corners being symmetrical thereto.

The broken lines illustrate unclaimed features that form no part of the claimed design. The removable mattress cover is shown with broken gaps to represent indeterminate length and width. The indeterminate portions of the article form no part of the claimed design. Patentability is based only on those portions of the removable mattress cover that are shown in solid lines.

1 Claim, 16 Drawing Sheets

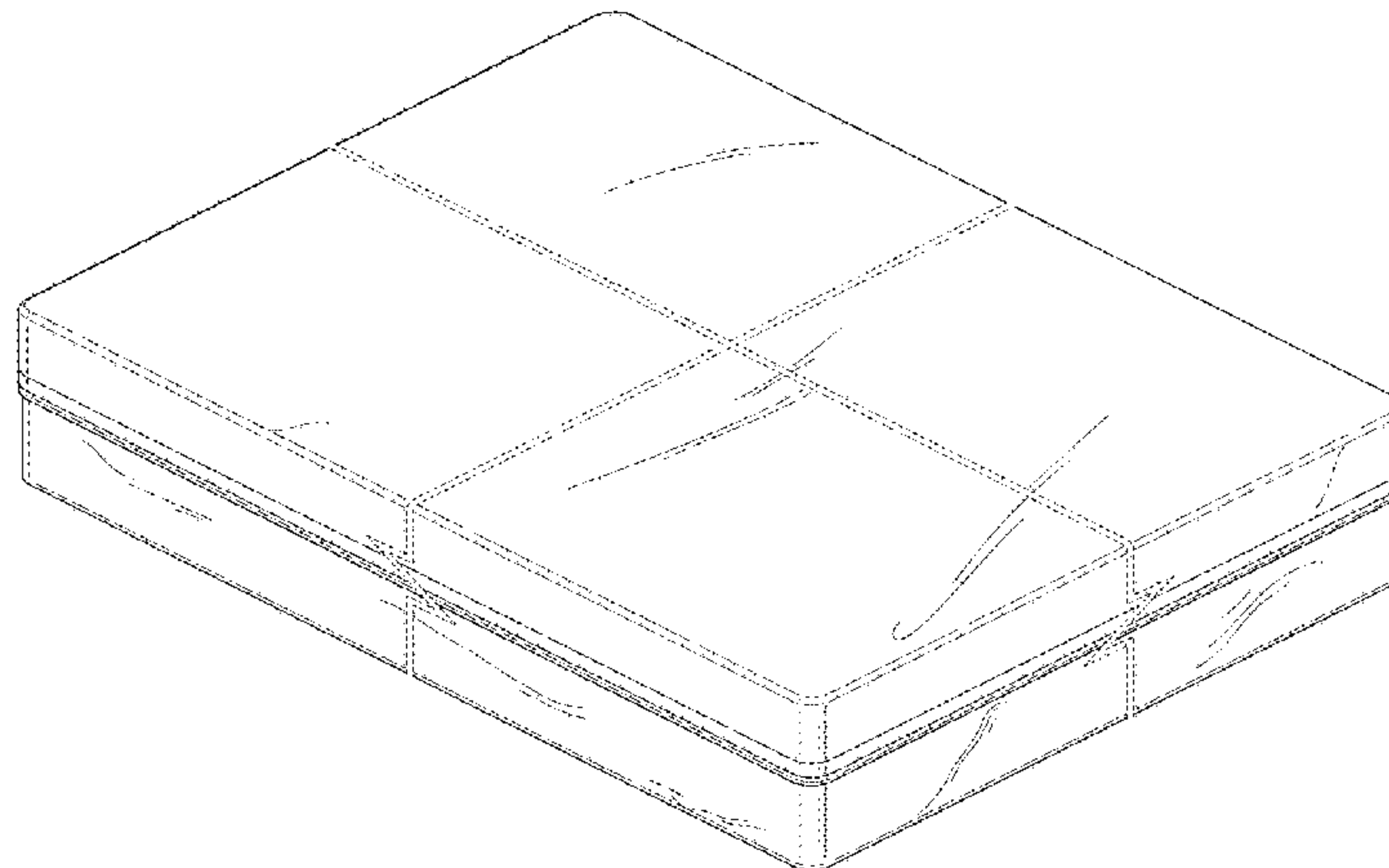

(58) **Field of Classification Search**

CPC A47G 9/00; A47G 2009/001; A47G
 2009/002; A47G 2009/003; A47G
 2009/005; A47G 2009/006; A47G 9/02;
 A47G 9/0207; A47G 9/0215; A47G
 9/0223; A47G 9/023; A47G 9/0238;
 A47G 9/0246; A47G 9/0253; A47G
 9/0261; A47G 9/06; A47G 9/062; A47G
 9/066; A47G 9/068; A47G 9/08; A47G
 2009/0276; A47G 9/0284; A47G 9/0292;
 A47G 9/04; A47G 9/10; A47C 27/22;
 A47C 21/02

See application file for complete search history.

(56) **References Cited**

U.S. PATENT DOCUMENTS

3,027,573 A * 4/1962 Bell, Jr. A47C 27/22
 5/500
 3,581,322 A * 6/1971 Marisco A47C 27/05
 5/699
 4,301,561 A * 11/1981 McLeod A47C 21/022
 5/496
 D313,140 S * 12/1990 Johnson D6/596
 5,118,553 A * 6/1992 Boisson A47G 9/0238
 24/381
 D338,796 S * 8/1993 Staudinger D6/596

5,465,440 A * 11/1995 Heptner A47G 9/0246
 5/495
 6,757,923 B2 * 7/2004 Sopher A47G 9/0246
 5/496
 6,859,962 B2 * 3/2005 Diak/Ghanem A47G 9/02
 5/484
 7,047,580 B2 * 5/2006 Finn A47C 31/105
 5/484
 D571,594 S * 6/2008 Klepy D6/595
 D593,788 S * 6/2009 Thompson D6/602
 D598,231 S * 8/2009 Thompson D6/602
 D629,242 S * 12/2010 Waite D6/603
 7,930,779 B2 * 4/2011 Marrache A47C 27/005
 5/496
 8,032,959 B2 * 10/2011 Rowson A47G 9/02
 5/488
 8,117,692 B1 * 2/2012 Richards A47C 31/105
 5/482
 D663,989 S * 7/2012 Steffey D6/602
 D700,791 S * 3/2014 Curtis D6/602
 D713,655 S * 9/2014 Blatt D6/596
 9,247,835 B2 * 2/2016 Blethen A47G 9/0246
 9,265,368 B2 * 2/2016 Blethen A47G 9/0238
 D756,688 S * 5/2016 Mikesell D6/603
 2002/0148047 A1 * 10/2002 Corzani A47C 27/006
 5/738
 2010/0251482 A1 * 10/2010 MacDonald A47G 9/02
 5/494
 2012/0204348 A1 * 8/2012 Bayer A47G 9/02
 5/413 R

* cited by examiner

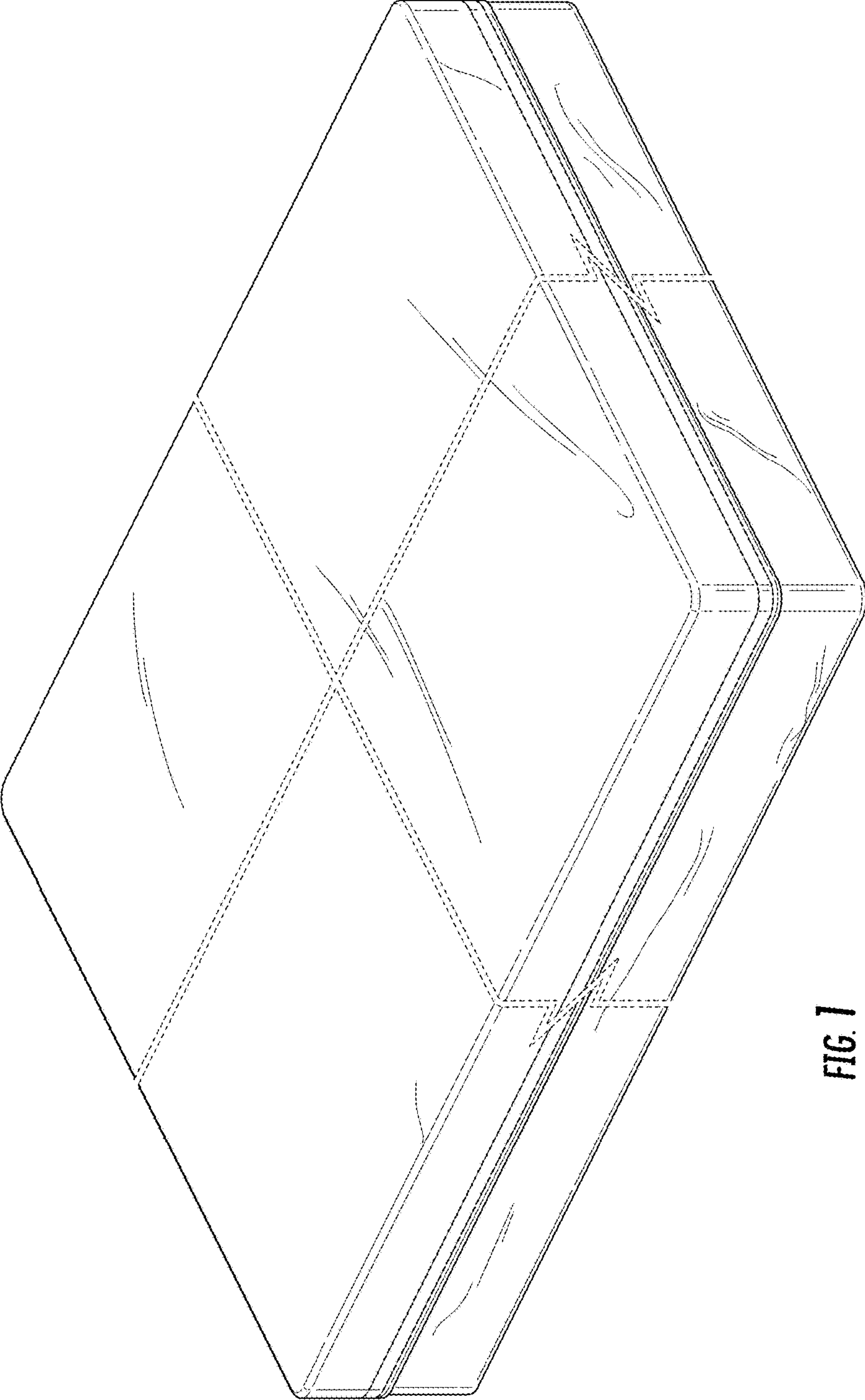

FIG. 1

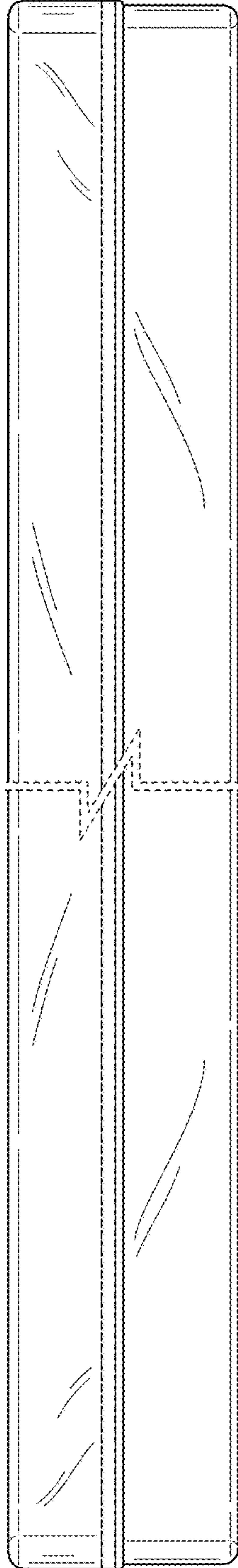

FIG. 2

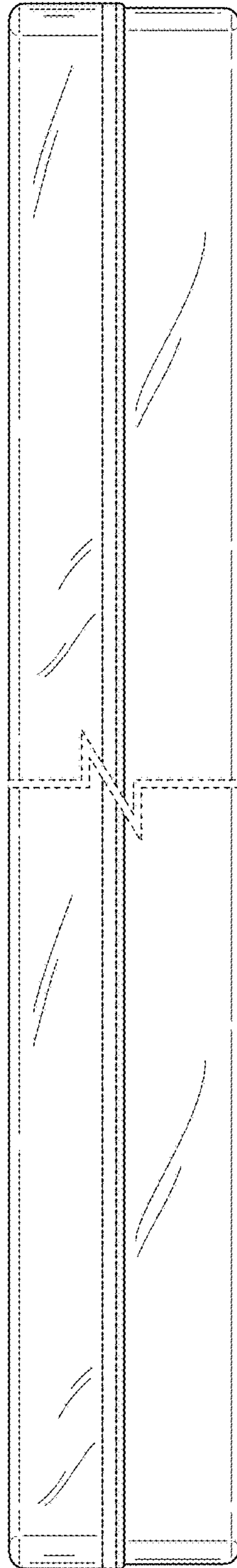

FIG. 3

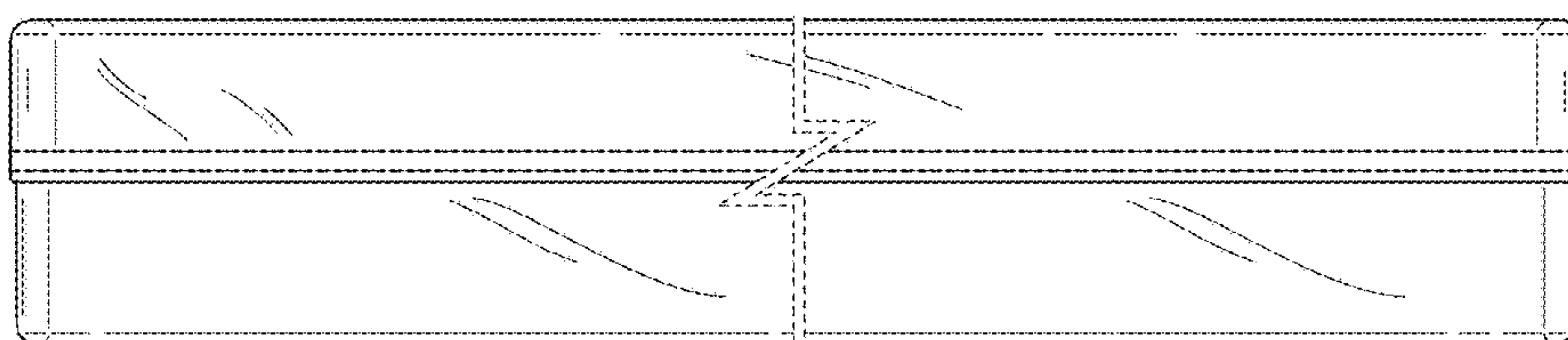

FIG. 4

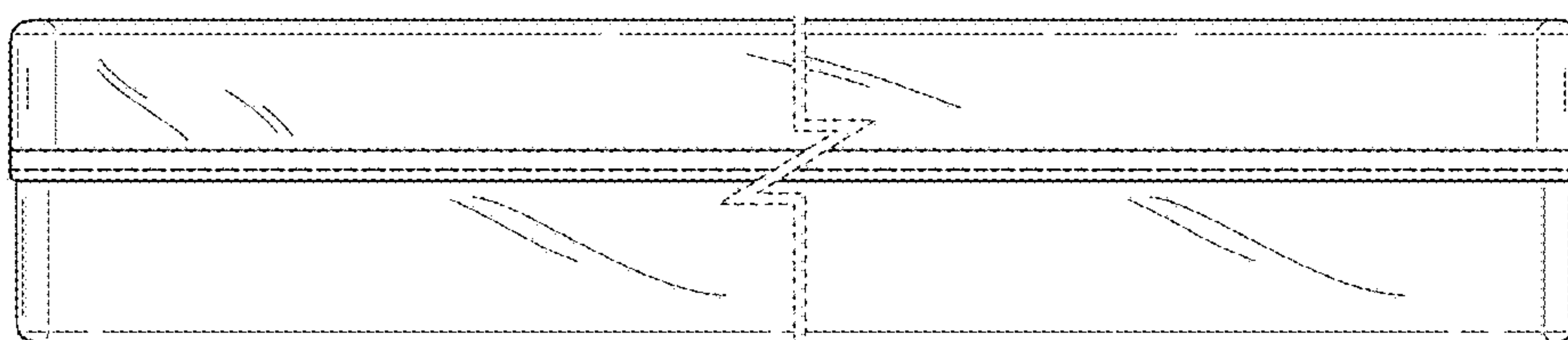

FIG. 5

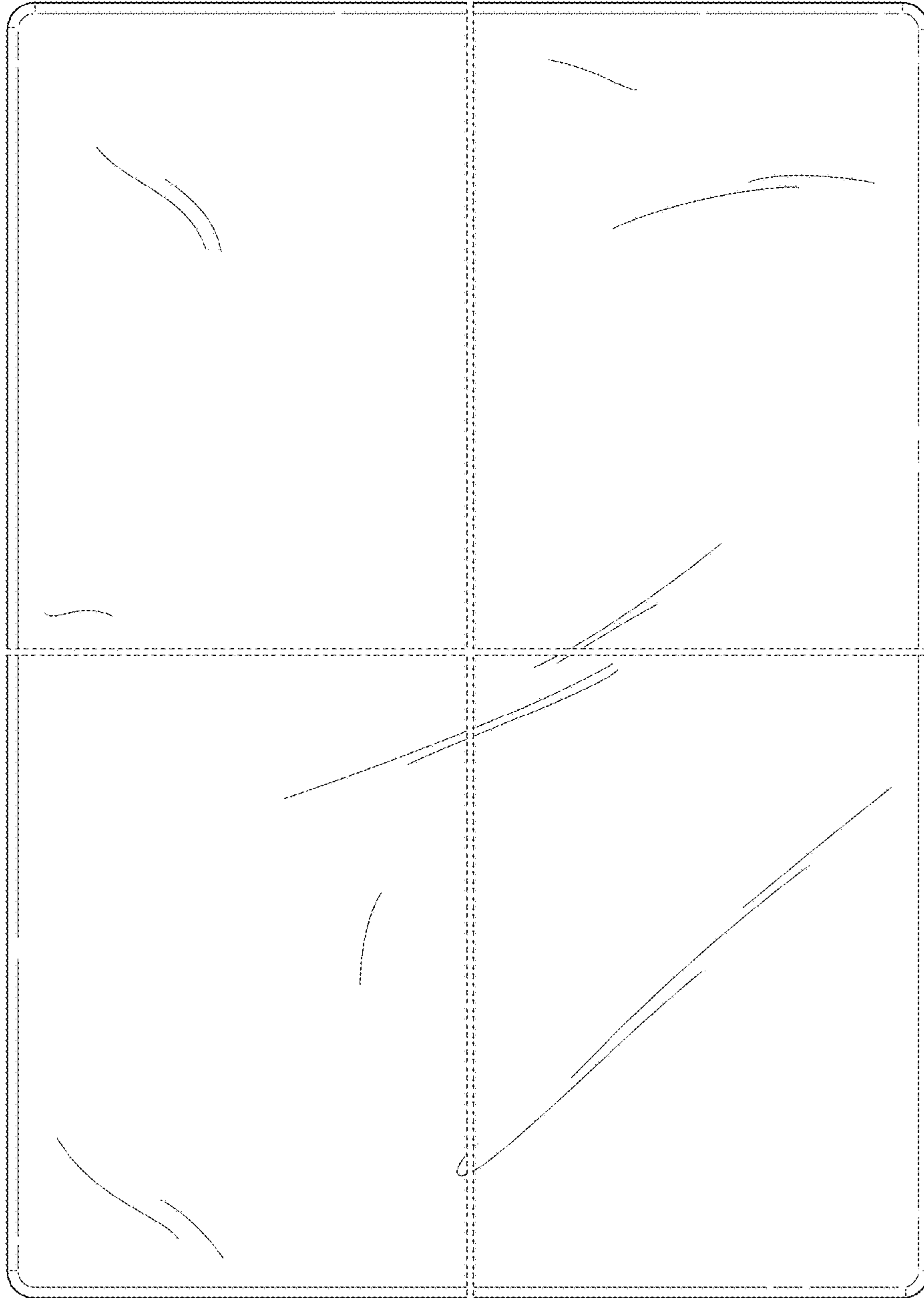

FIG. 6

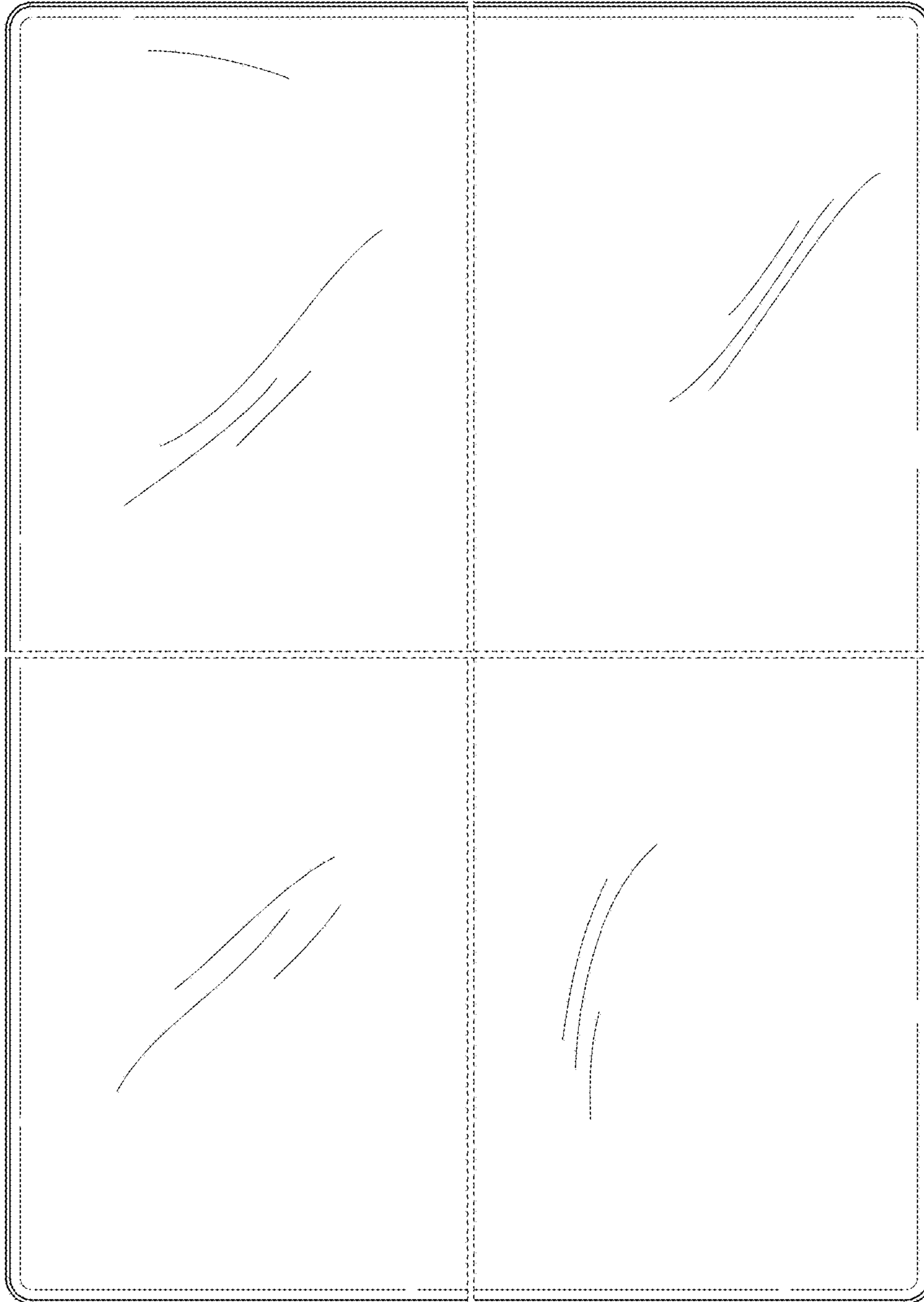

FIG. 7

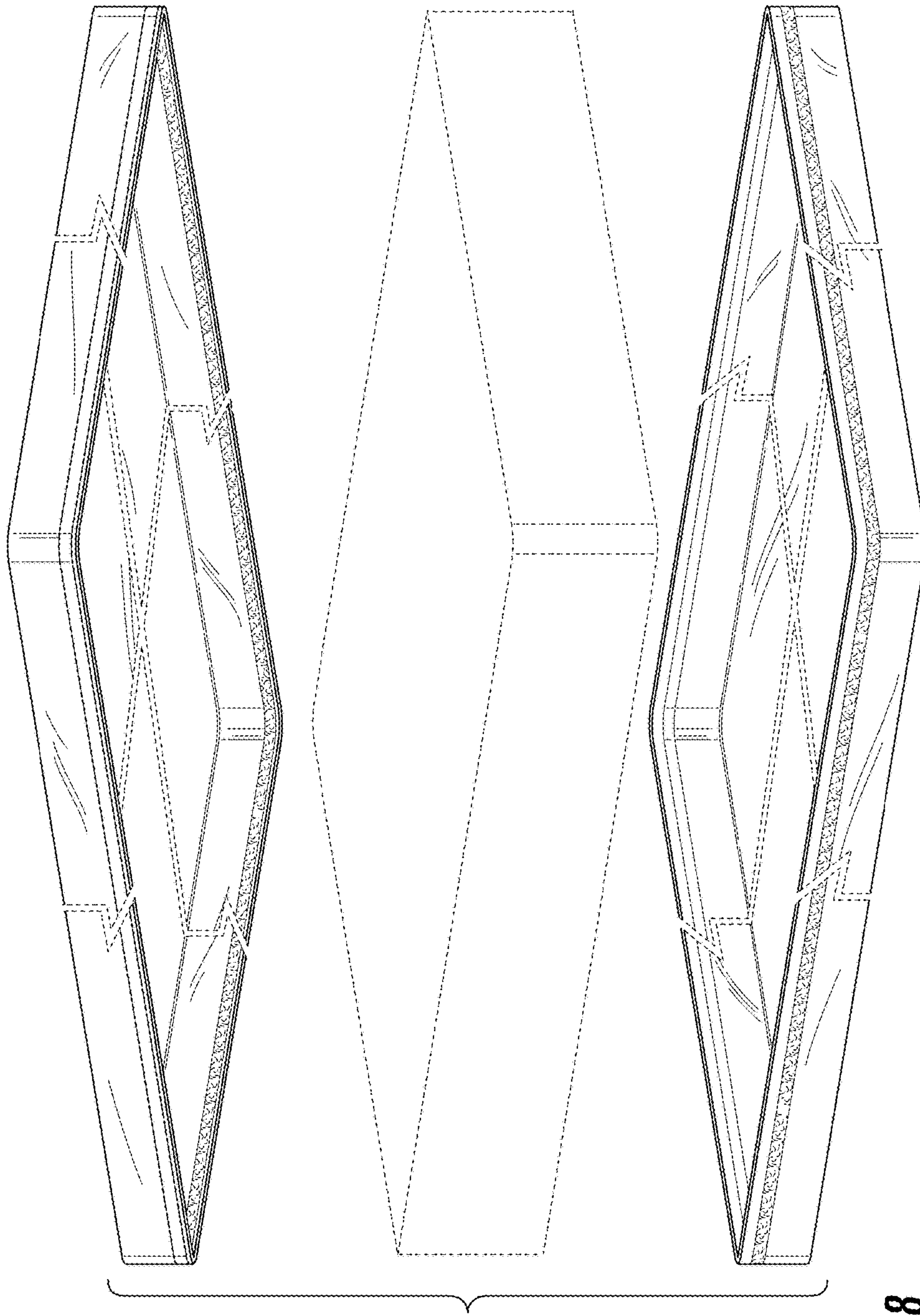

FIG. 8

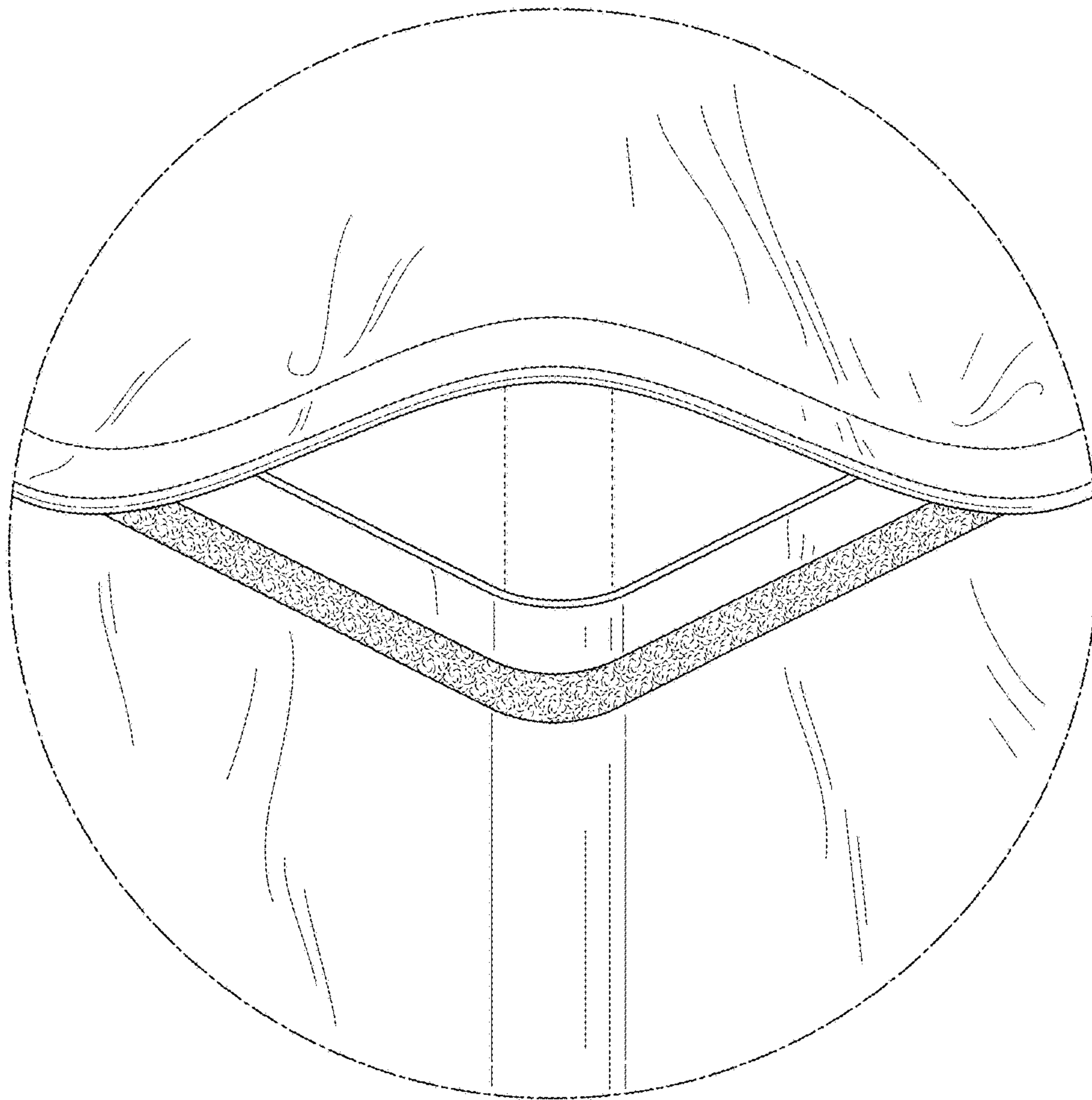

FIG. 9

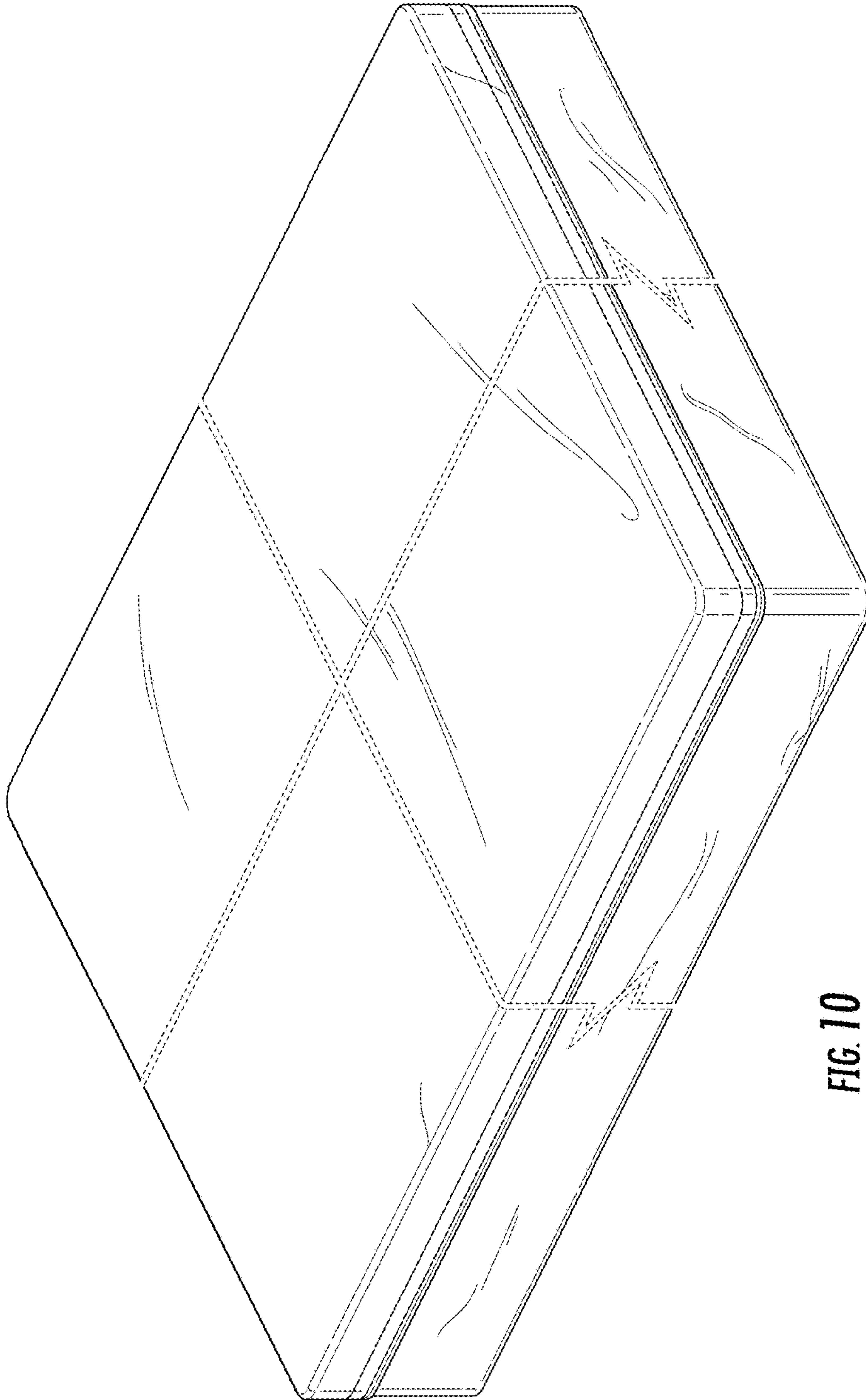

FIG. 10

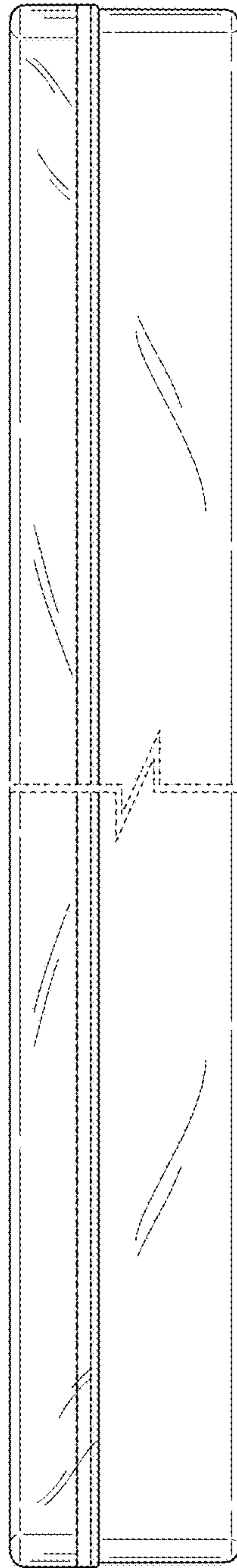

FIG. 11

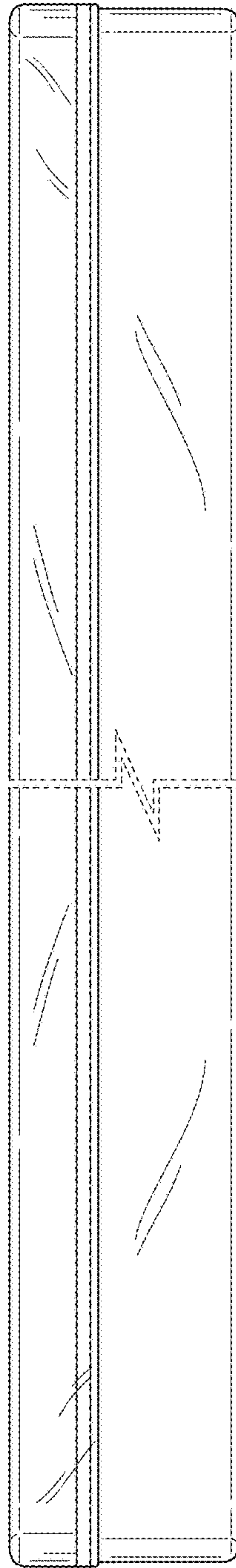

FIG. 12

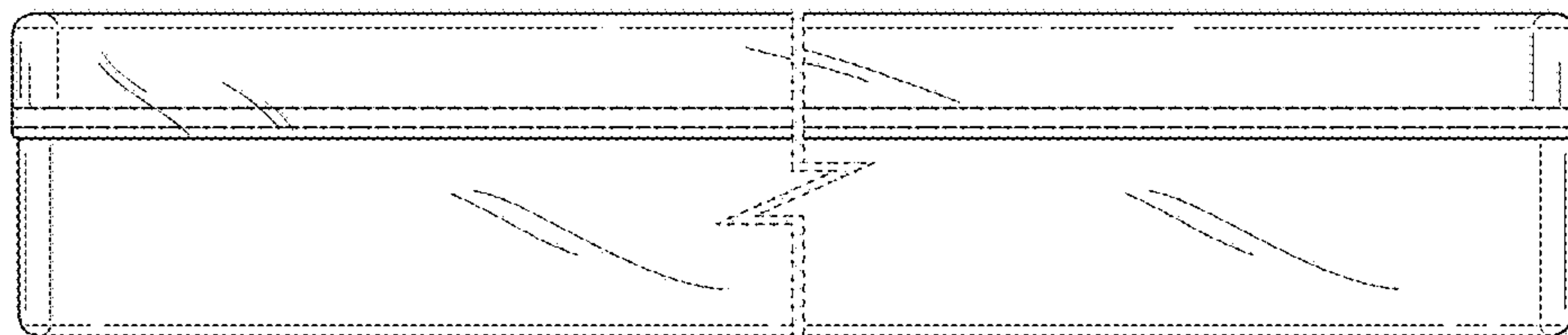

FIG. 13

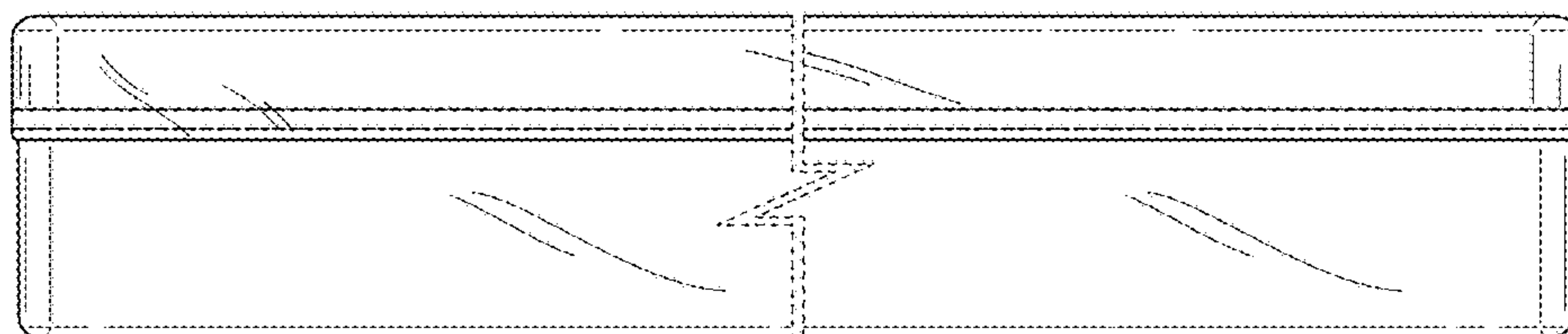

FIG. 14

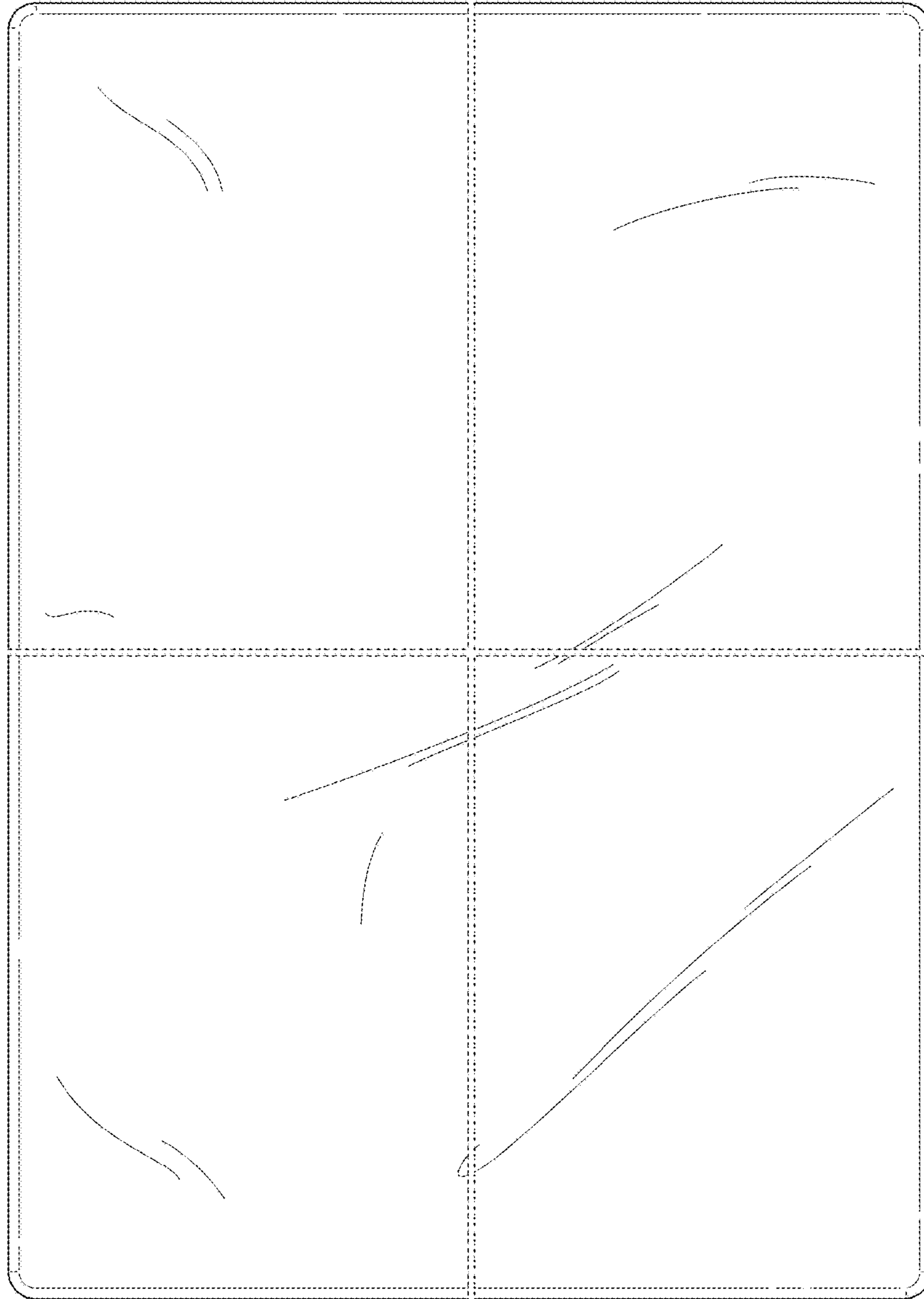

FIG. 15

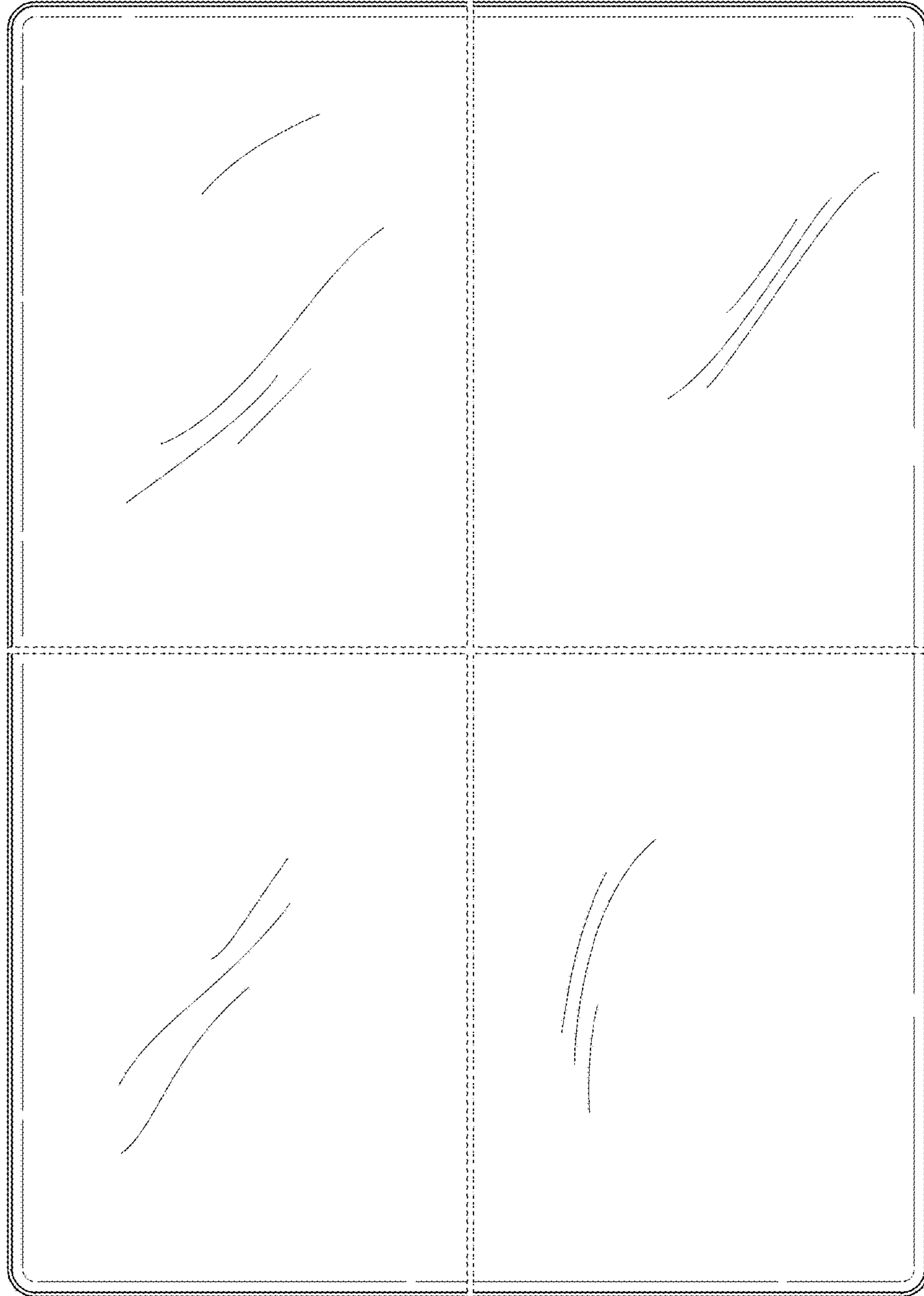

FIG. 16

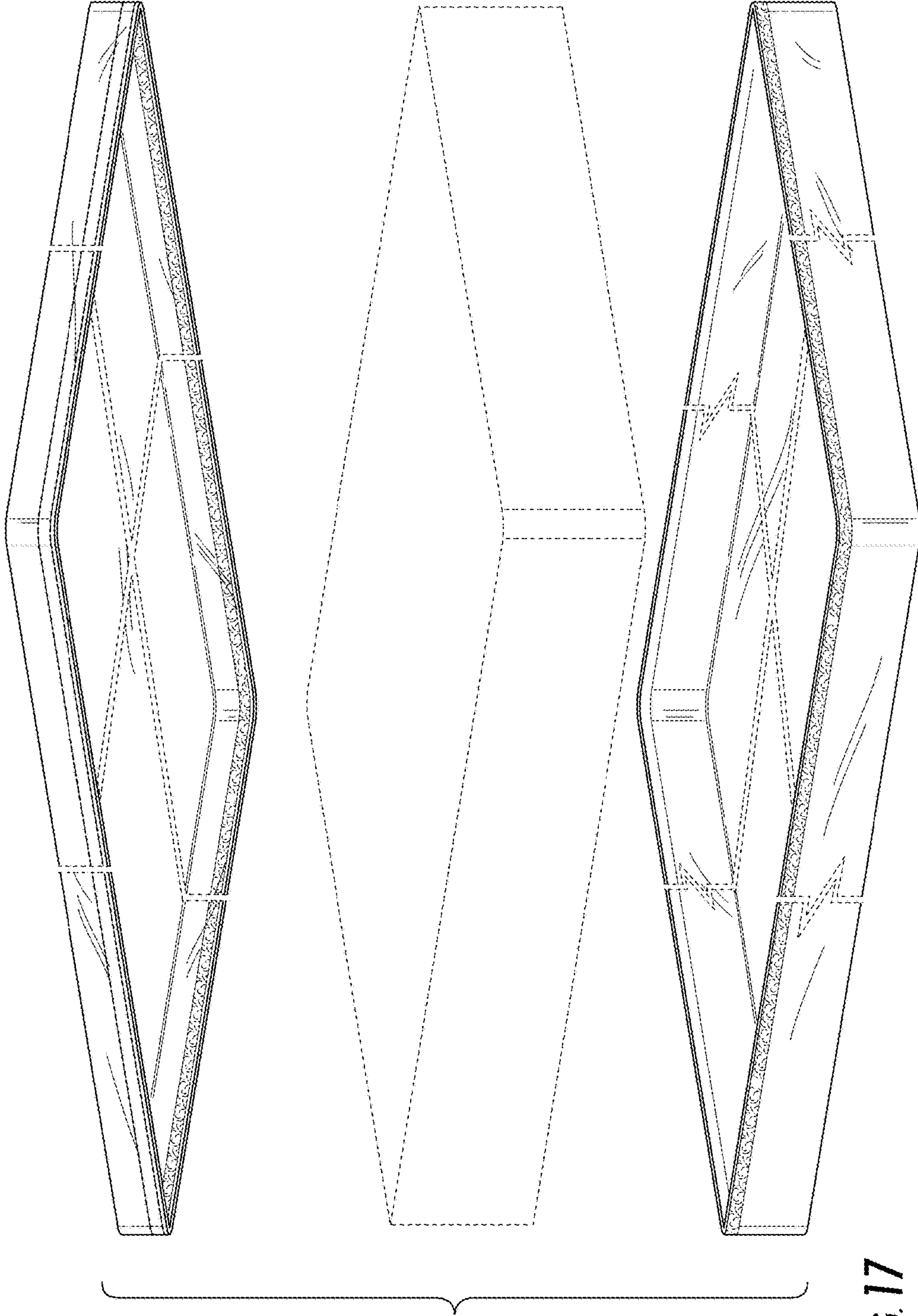

FIG. 17

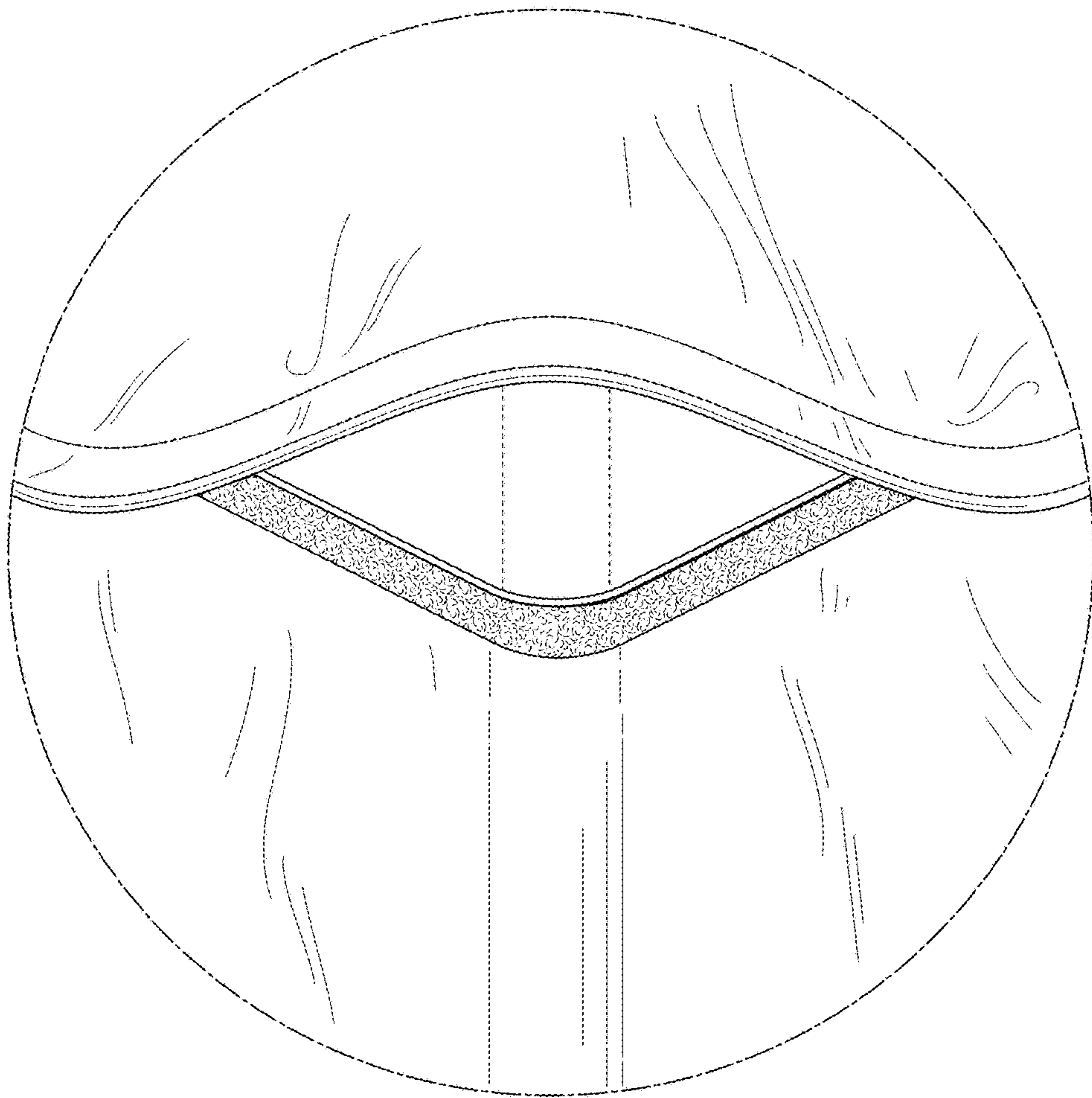

FIG. 18