



US00D794914S

(12) **United States Design Patent** (10) **Patent No.:** **US D794,914 S**
Auble (45) **Date of Patent:** **** Aug. 22, 2017**

- (54) **ACTIVITY SKIRT**
- (71) Applicant: **Cristy Lee Auble**, Flagstaff, AZ (US)
- (72) Inventor: **Cristy Lee Auble**, Flagstaff, AZ (US)
- (**) Term: **15 Years**
- (21) Appl. No.: **29/568,657**
- (22) Filed: **Jun. 20, 2016**
- (51) **LOC (10) Cl.** **02-02**
- (52) **U.S. Cl.**
USPC **D2/851; D2/731**
- (58) **Field of Classification Search**
USPC D2/851, 731, 735, 756, 752, 738; 2/212, 2/213
CPC ... A41D 1/14; A41D 1/22; A41D 1/16; A41D 11/00; A41D 13/012; A41D 13/1254; A41D 13/0015; A41D 15/02
See application file for complete search history.

2012/0090076 A1* 4/2012 Kenney A41D 15/02 2/212

* cited by examiner

Primary Examiner — Robin V Webster
Assistant Examiner — James Thorn, Sr.
(74) *Attorney, Agent, or Firm* — Invention To Patent Services; Alex Hobson

(57) **CLAIM**

The ornamental design for an activity skirt, as shown and described.

DESCRIPTION

FIG. 1 is a back view of an activity skirt;
 FIG. 2 is a front view of an activity skirt;
 FIG. 3 is a right view of an activity skirt;
 FIG. 4 is a left view of an activity skirt;
 FIG. 5 is a back view of an activity skirt with the skirt portion flipped up to show the shorts portion, for ease of illustration;
 FIG. 6 is a perspective back view of an activity skirt;
 FIG. 7 is a back view of an activity skirt;
 FIG. 8 is a front view of an activity skirt;
 FIG. 9 is a right view of an activity skirt;
 FIG. 10 is a left view of an activity skirt;
 FIG. 11 is a back view of an activity skirt with the skirt portion flipped up to show the shorts portion, for ease of illustration;
 FIG. 12 is a perspective back view of an activity skirt;
 FIG. 13 is a perspective front view of an activity skirt donned on a person;
 FIG. 14 is a perspective back view of an activity skirt donned on a person; and,
 FIG. 15 is a perspective side view of an activity skirt donned on a person.
 The activity skirt comprises a pleated skirt portion attached to a shorts portion. The person shown in FIGS. 13 to 15 forms no part of the claimed design.

(56) **References Cited**

U.S. PATENT DOCUMENTS

1,250,004	A *	12/1917	Philip	A41D 15/02
					2/213
2,791,779	A *	5/1957	Presson	A41D 1/14
					2/211
5,327,586	A *	7/1994	Evans	A41D 1/14
					2/211
5,802,619	A *	9/1998	Ralston	A41F 9/02
					2/220
6,009,558	A *	1/2000	Rosch	A41D 7/00
					2/212
6,282,723	B1 *	9/2001	Villegas	A41D 1/14
					2/211
D503,513	S *	4/2005	McCarthy	D2/735
D663,102	S *	7/2012	Hogg	D2/712
D712,632	S *	9/2014	Groh	D2/851
D735,972	S *	8/2015	Webster	D2/851
D756,070	S *	5/2016	Hershey	D2/851
D758,049	S *	6/2016	Molbeck	D2/851
2006/0010570	A1 *	1/2006	Villegas	A41D 1/14
					2/211

1 Claim, 15 Drawing Sheets

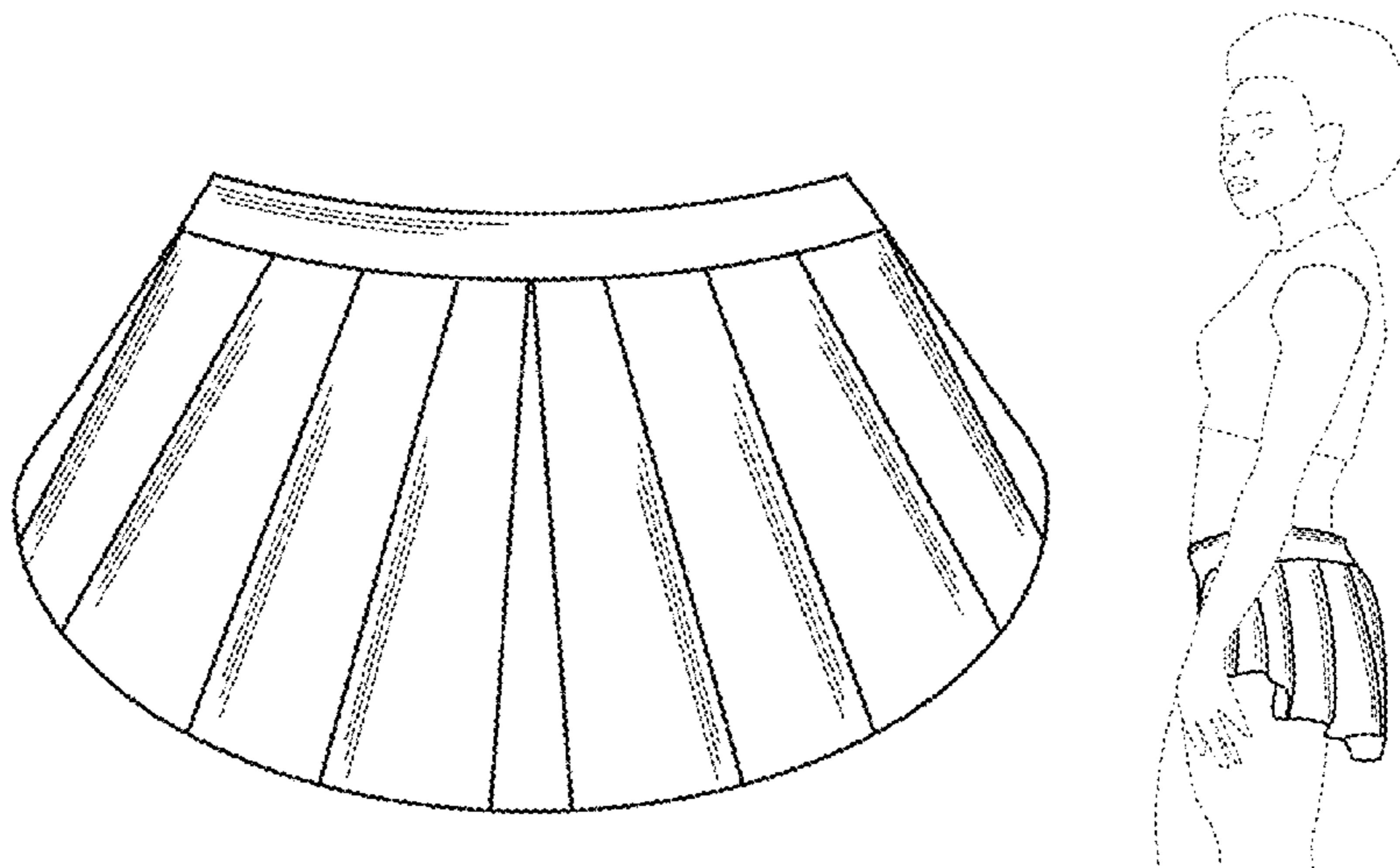

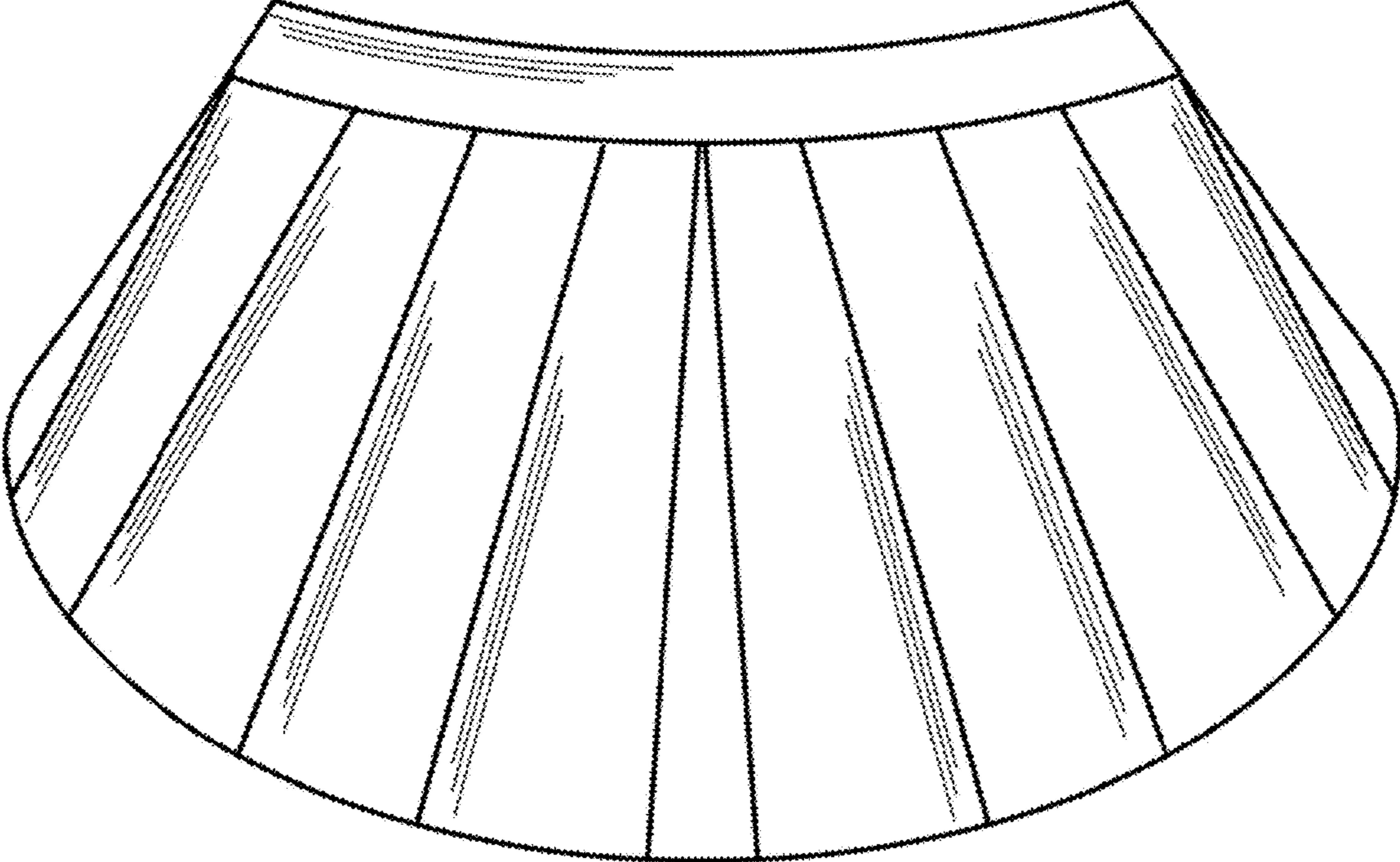

FIG. 1

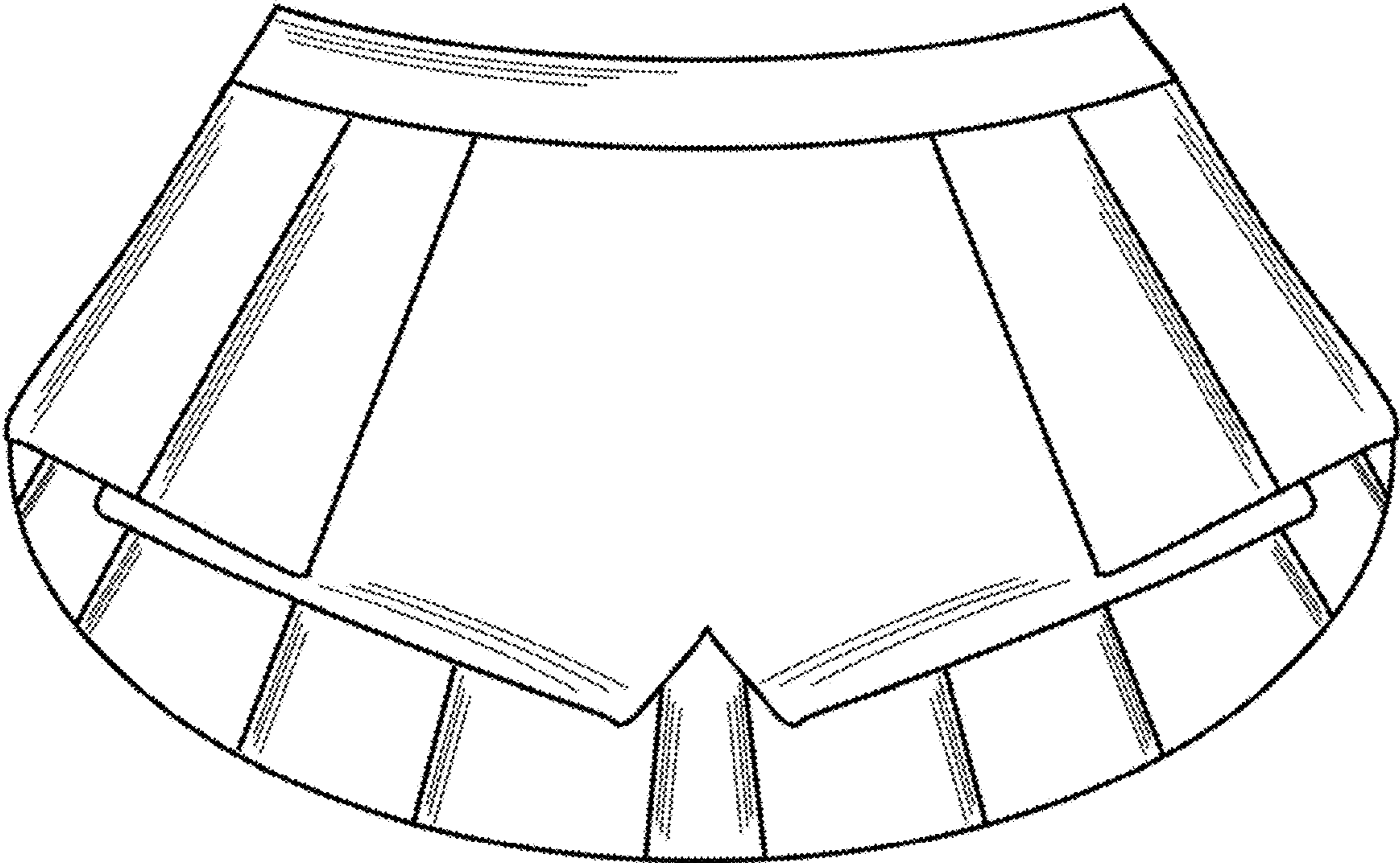

FIG. 2

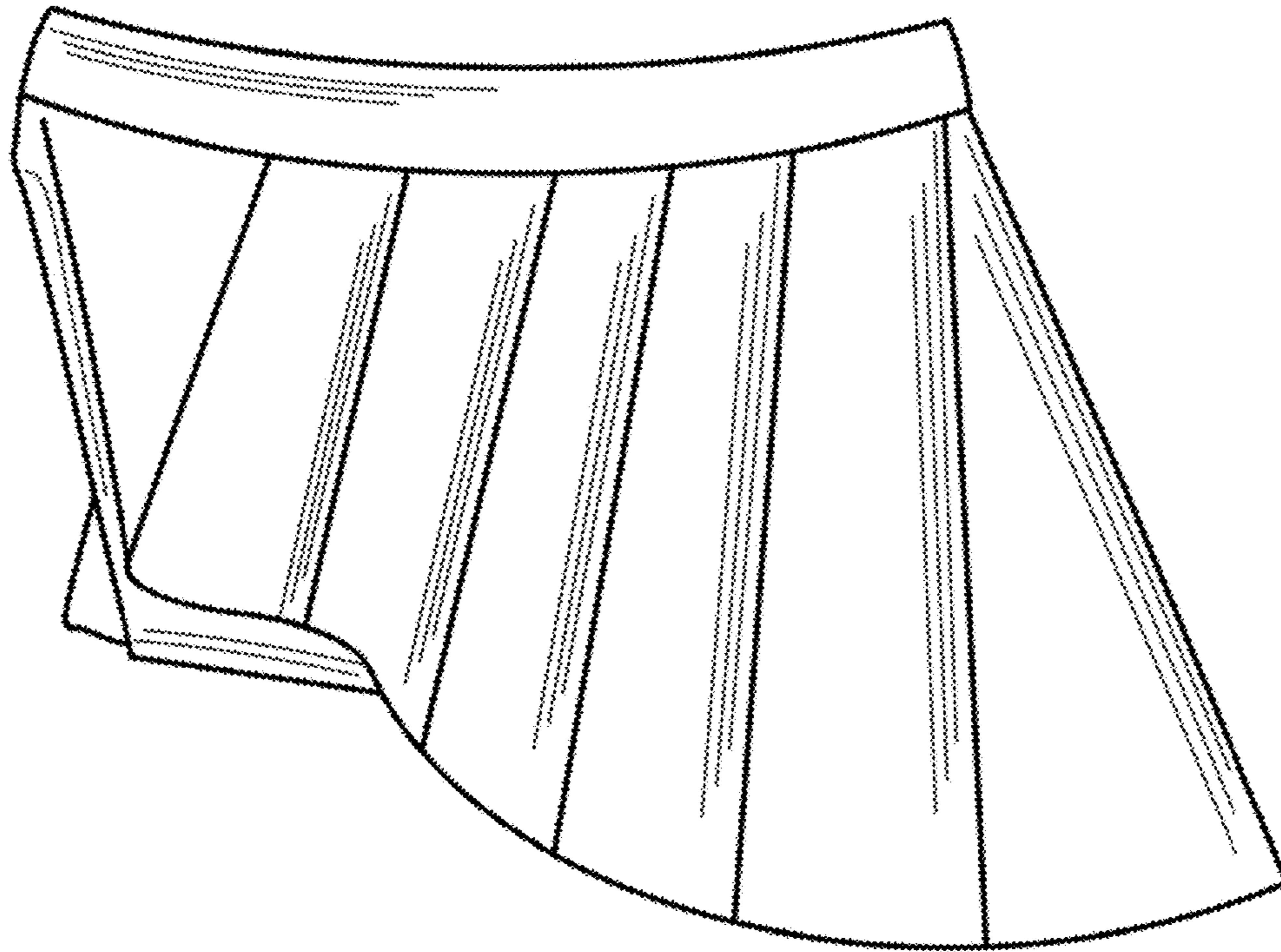

FIG. 3

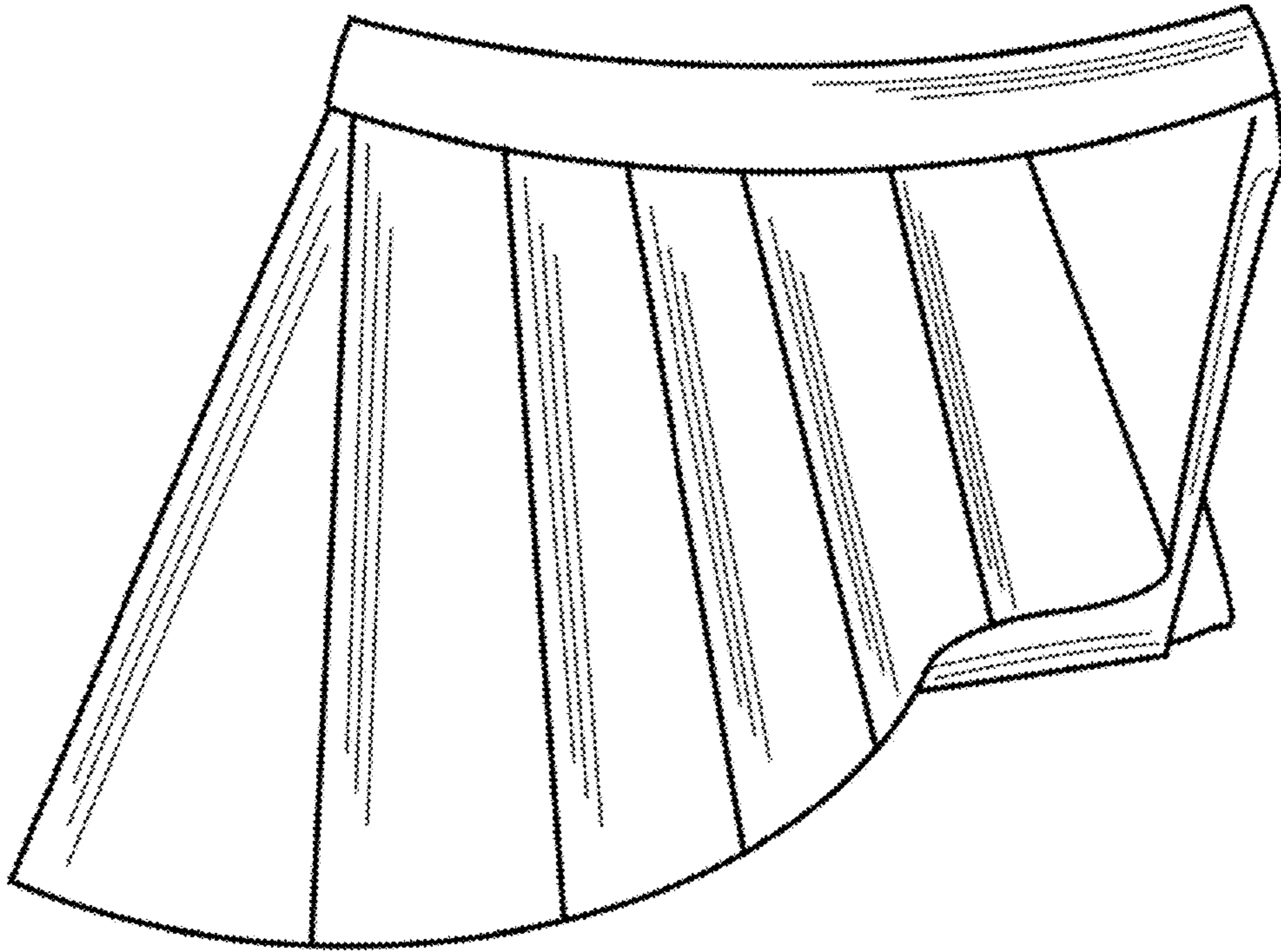

FIG. 4

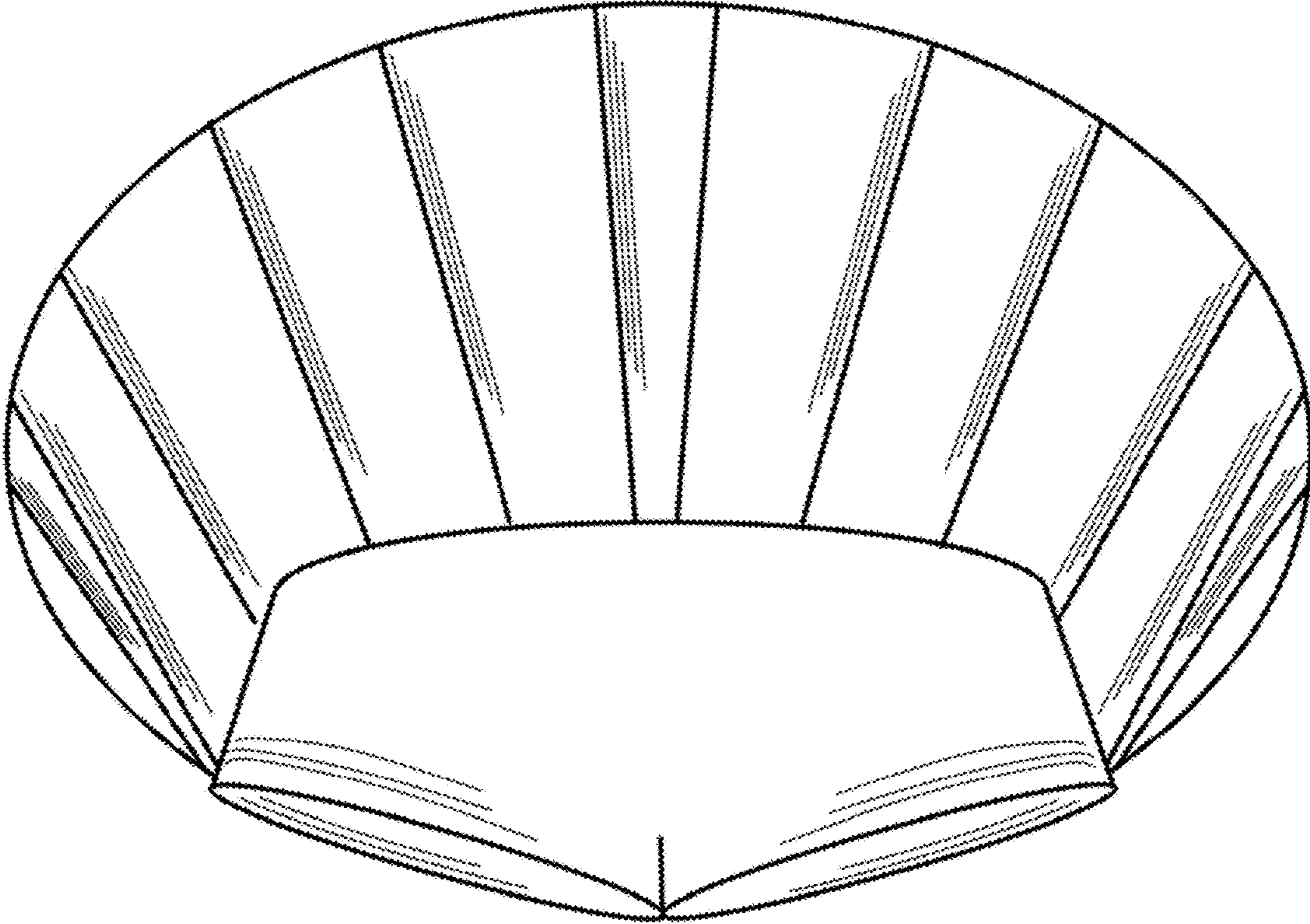

FIG. 5

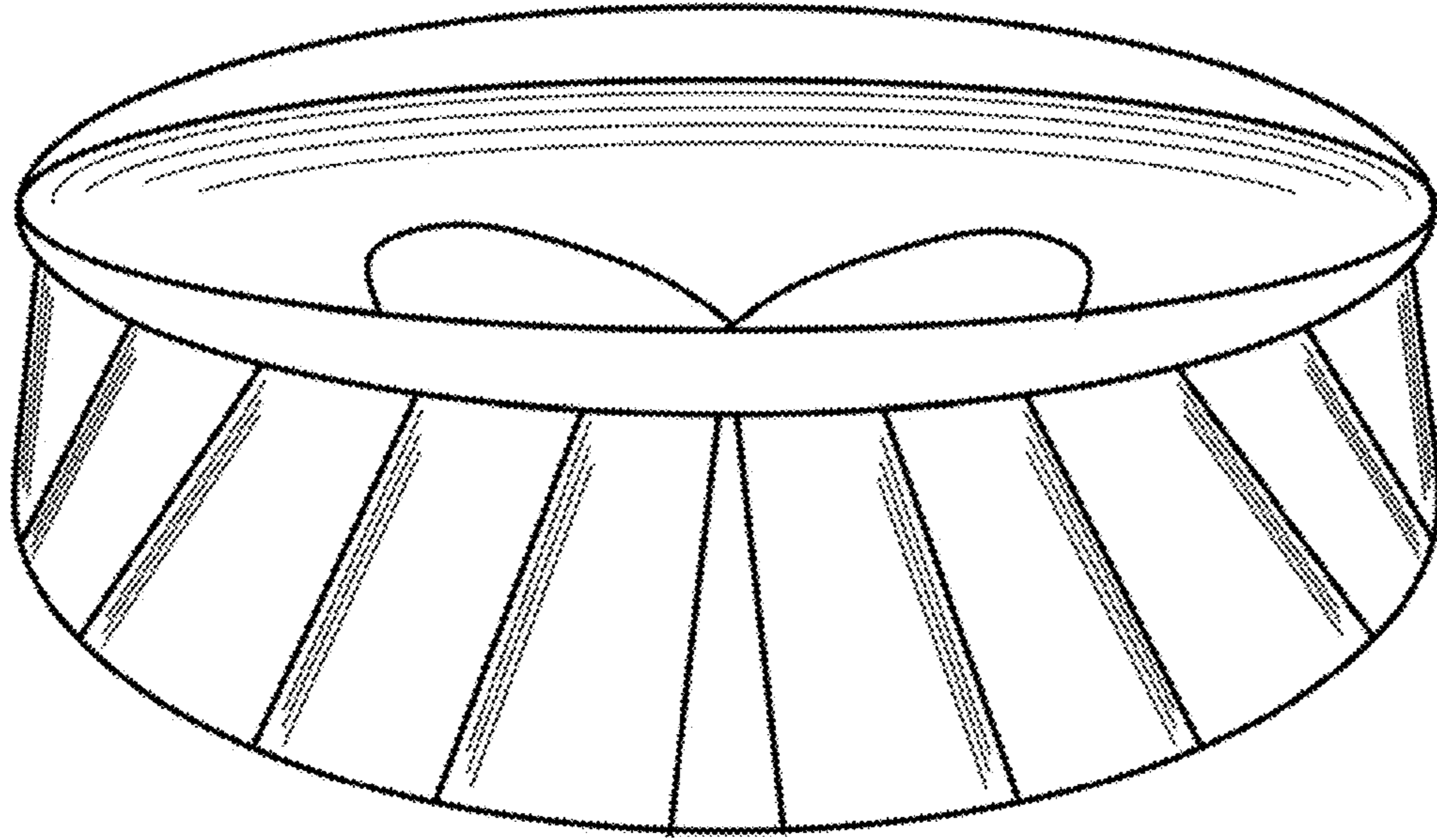

FIG. 6

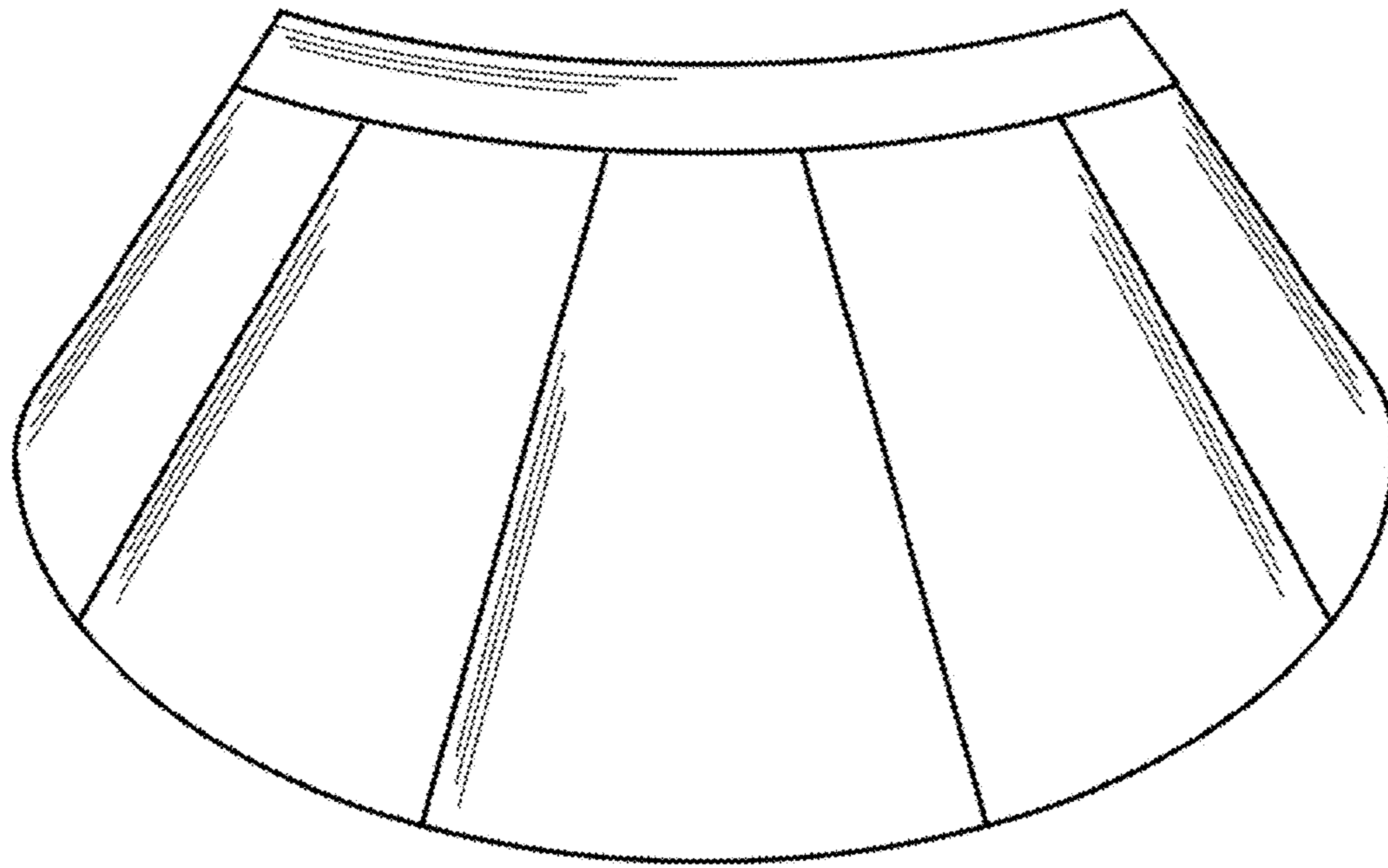

FIG. 7

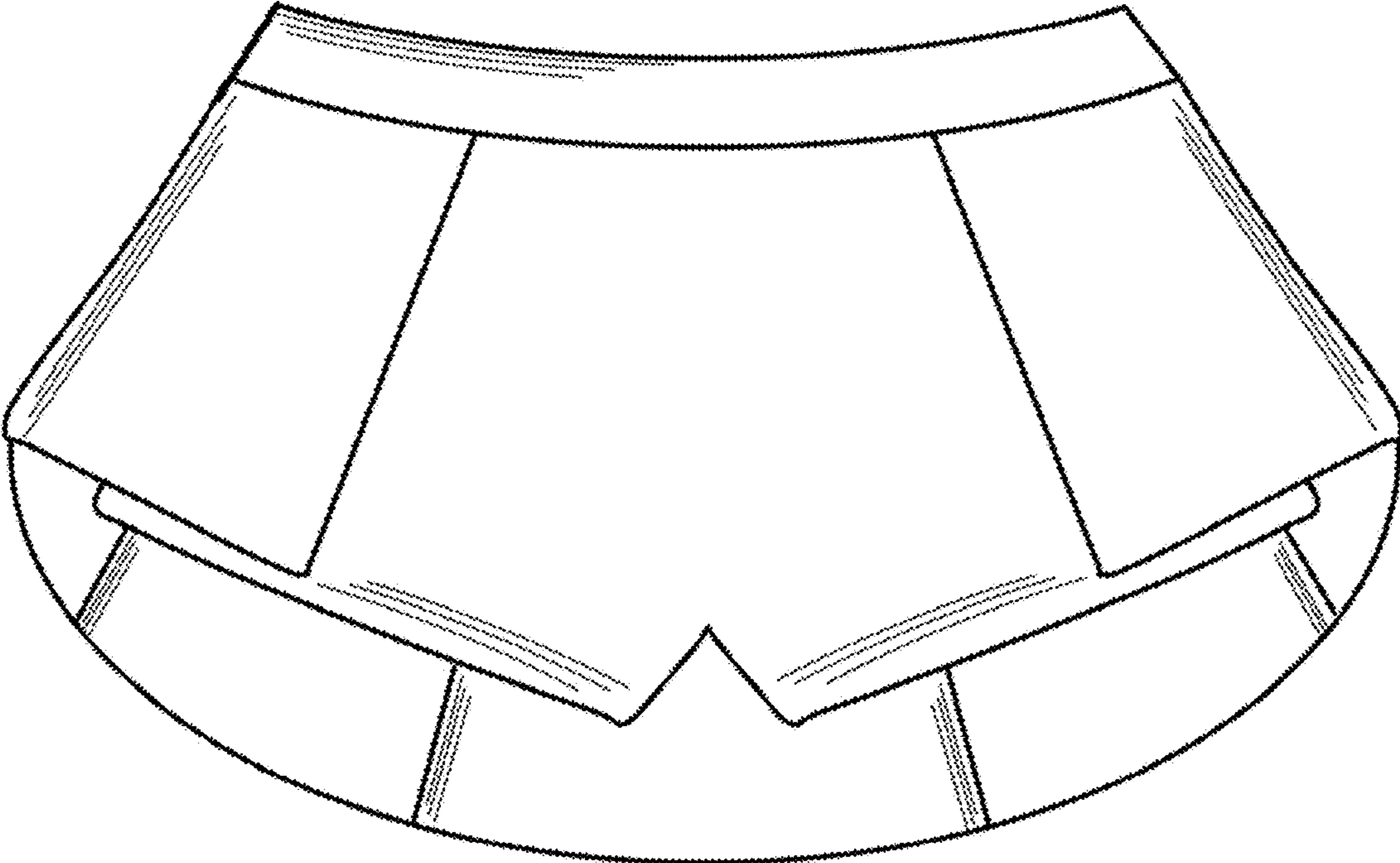

FIG. 8

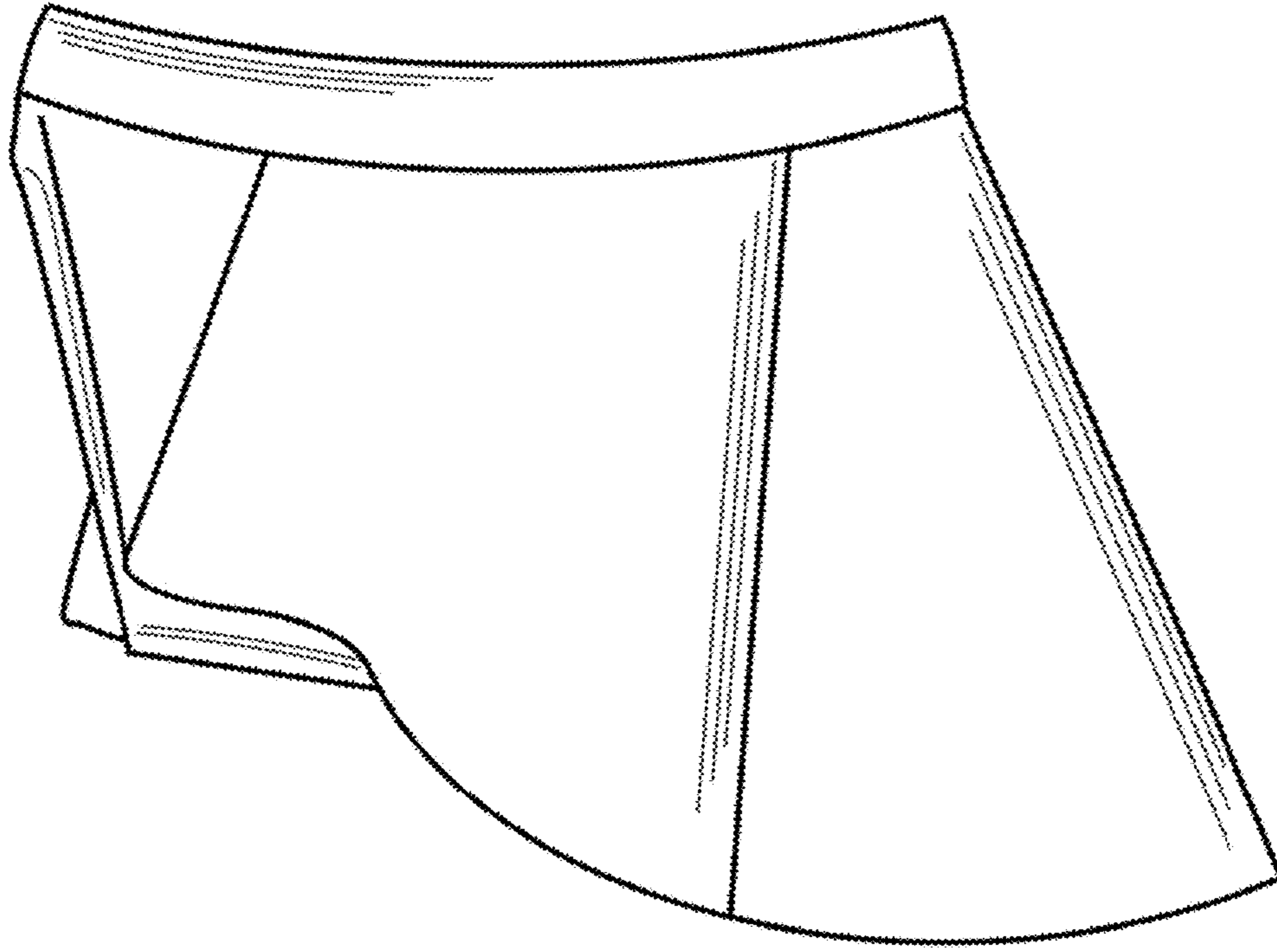

FIG. 9

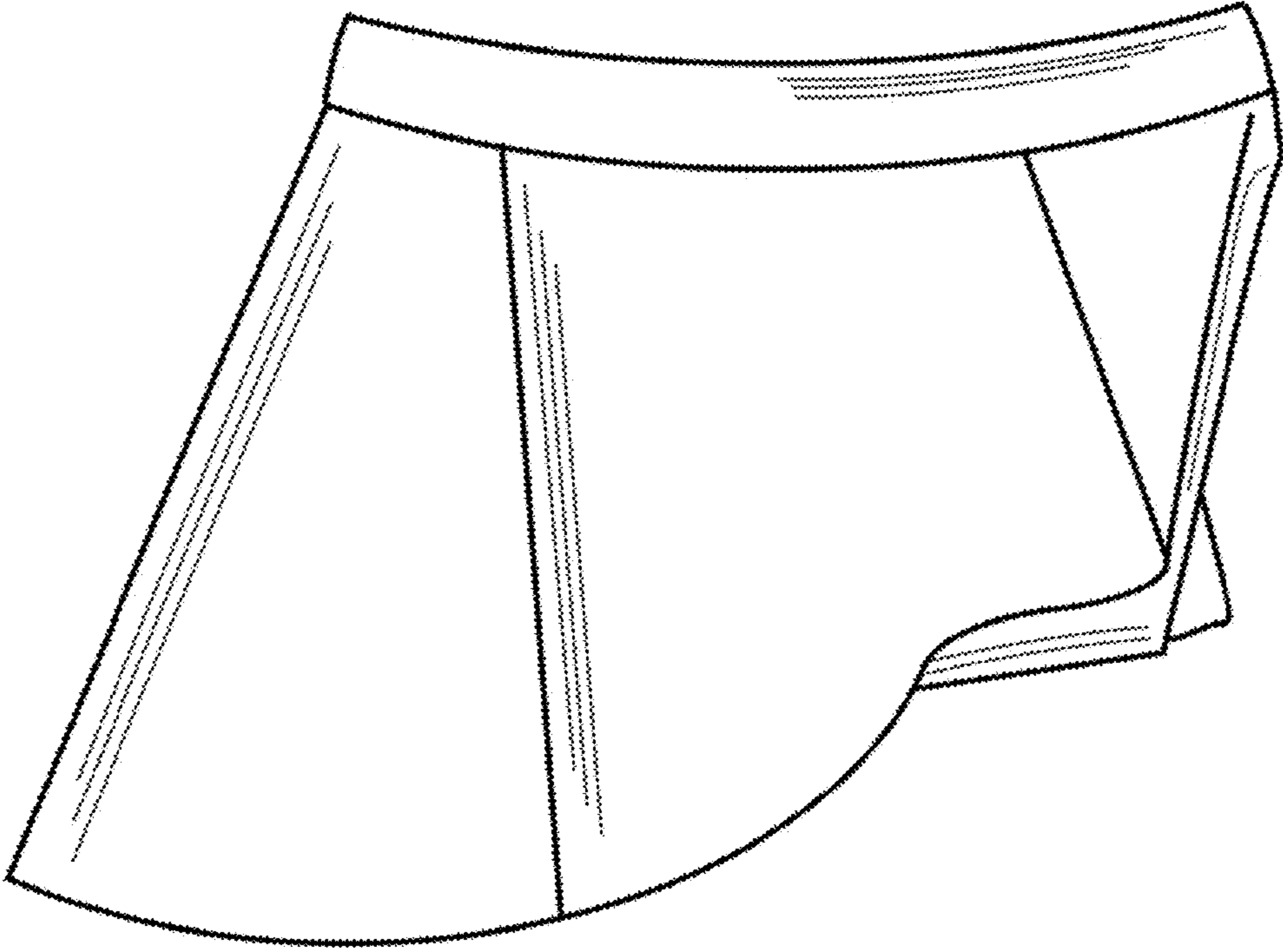

FIG. 10

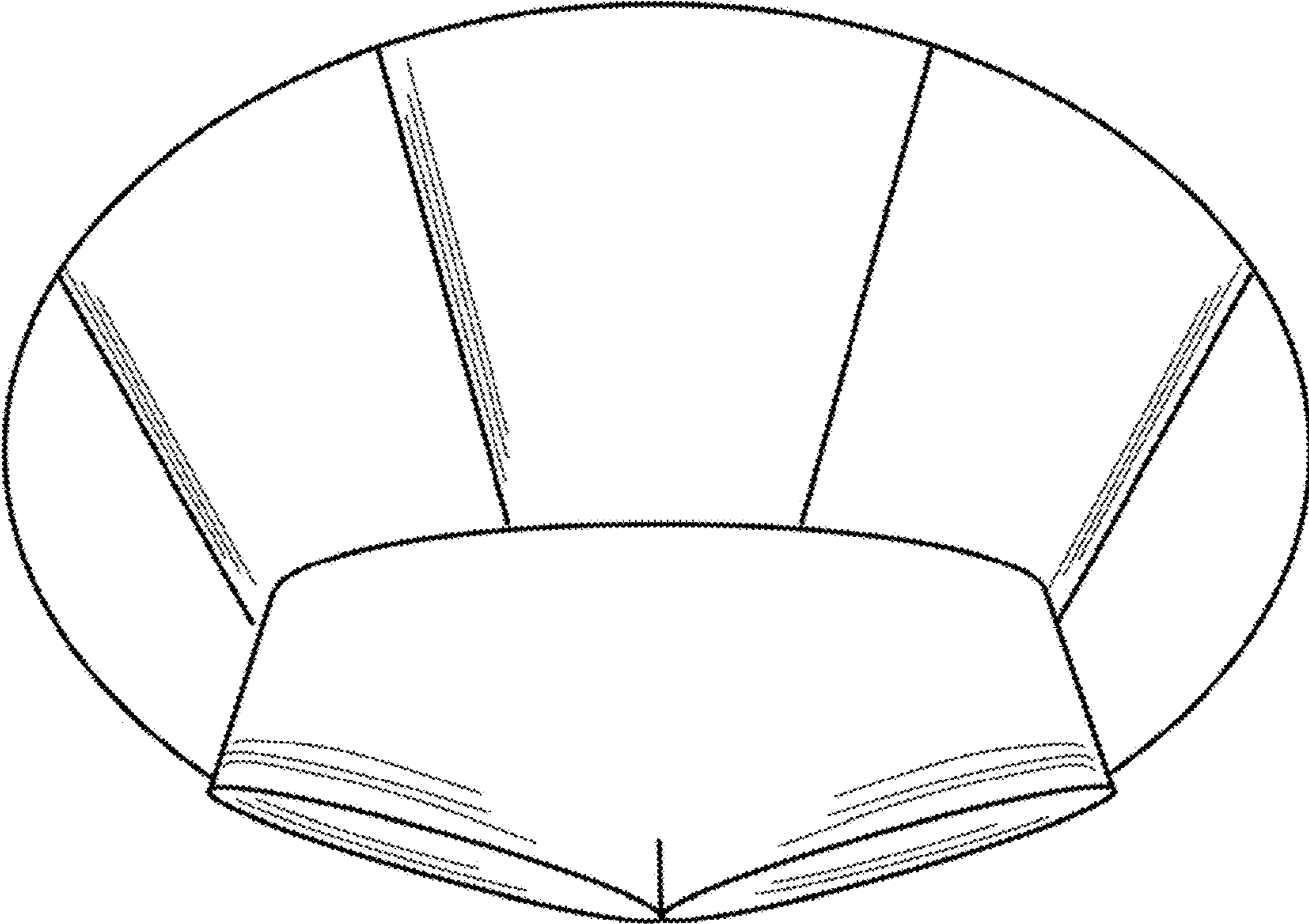

FIG. 11

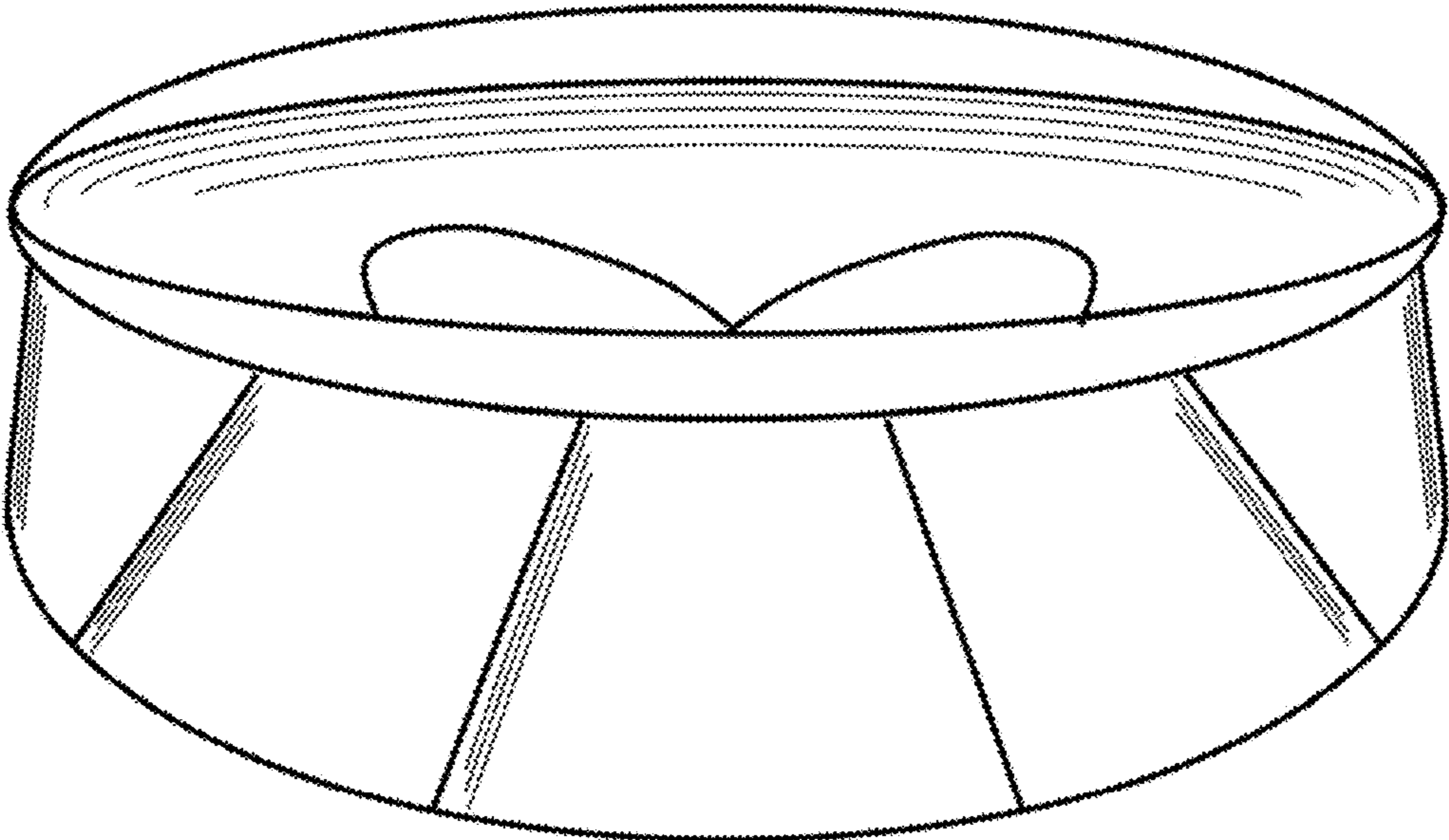

FIG. 12

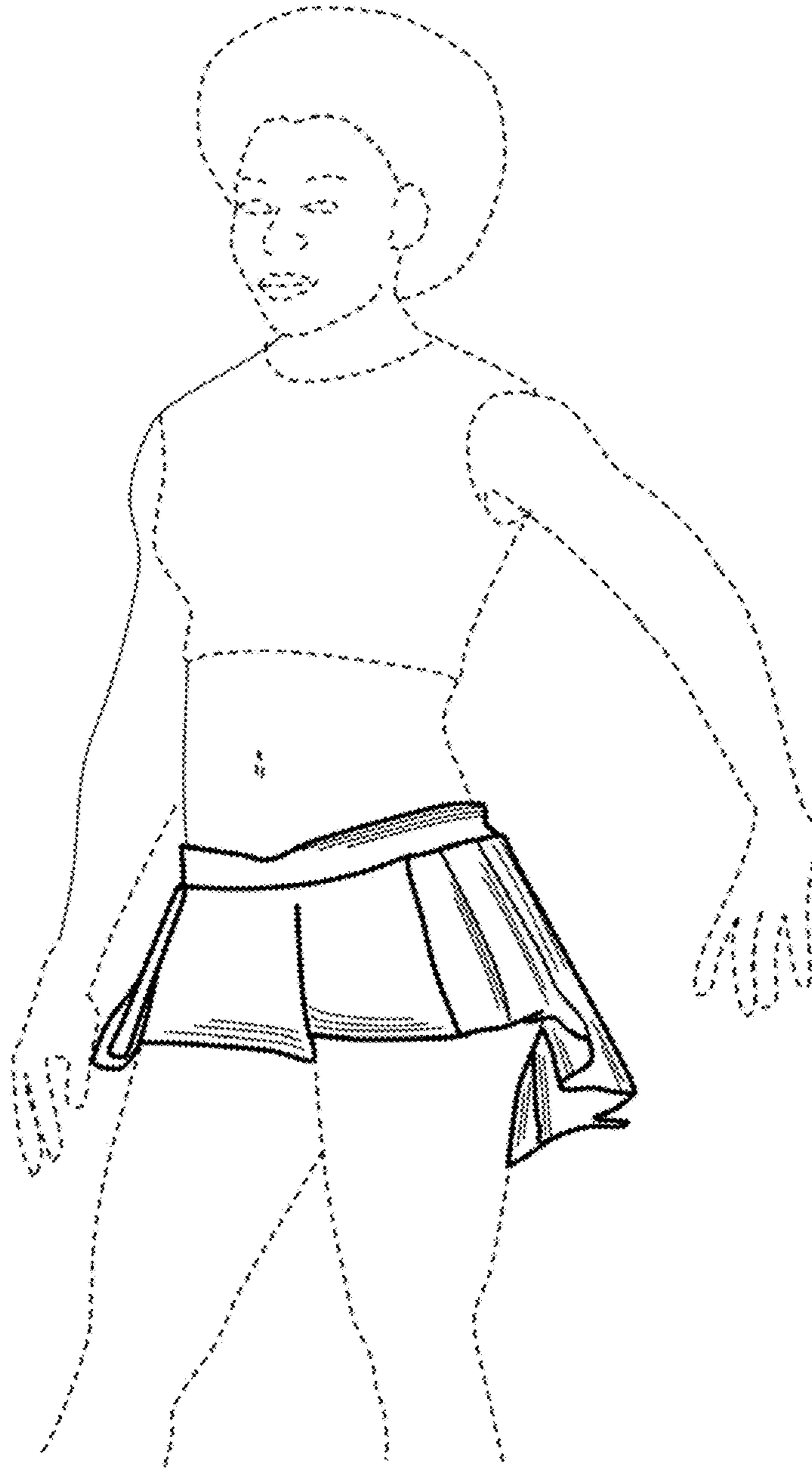

FIG. 13

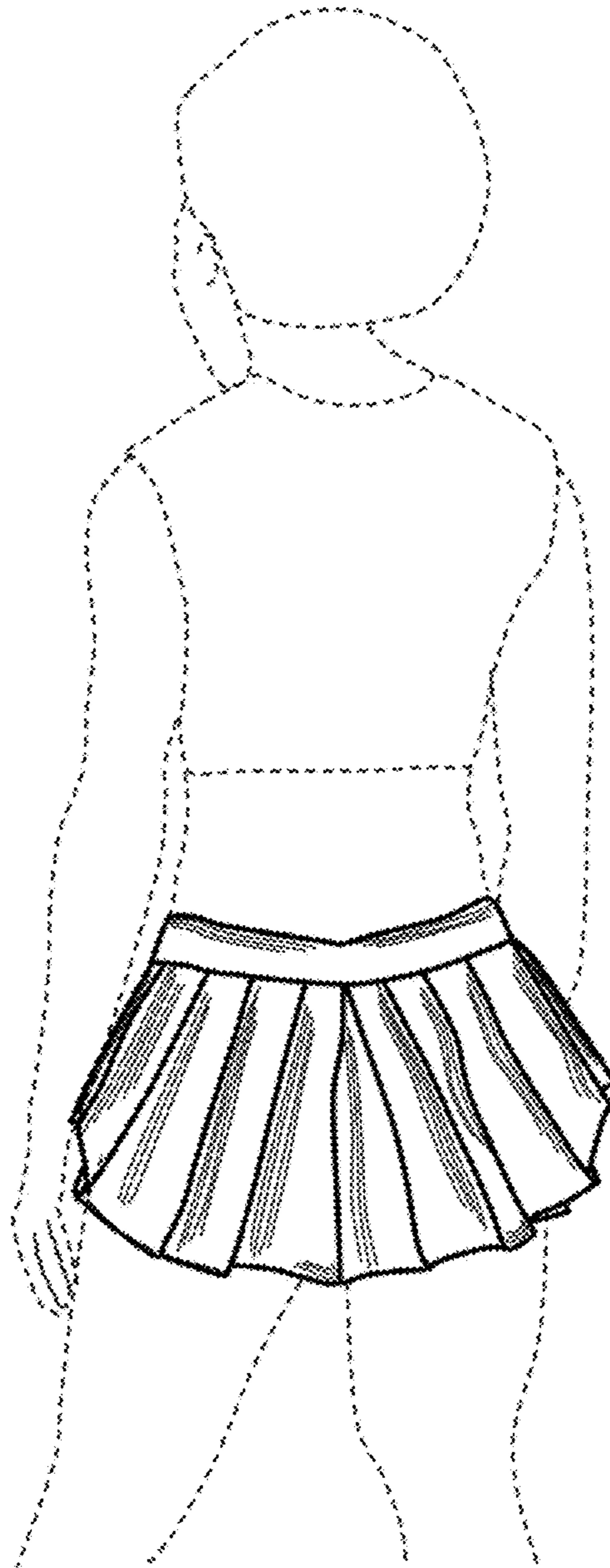

FIG. 14

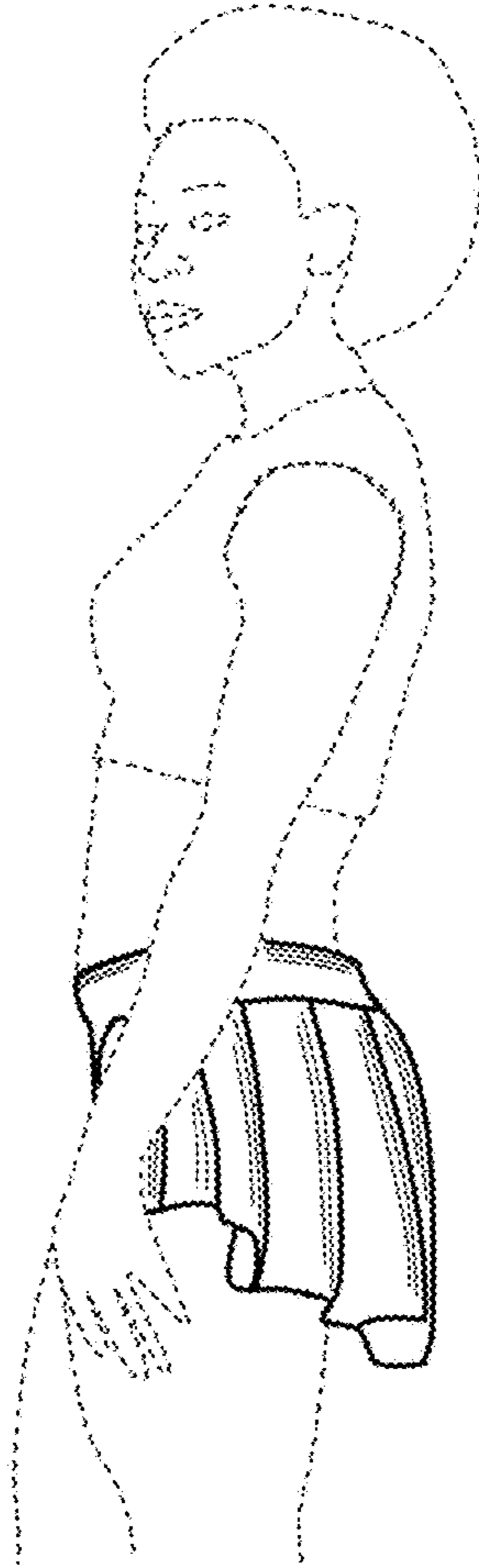

FIG. 15