



US00D794875S

(12) **United States Design Patent** (10) **Patent No.:** **US D794,875 S**
Hinze (45) **Date of Patent:** **** Aug. 15, 2017**

(54) **BOWL**

(57) **CLAIM**

(71) Applicant: **FUTURE CUPS GMBH & CO. KG,**
Hamburg (DE)

The ornamental design for a bowl, as shown and described.

(72) Inventor: **Jens Hinze,** Düsseldorf (DE)

DESCRIPTION

(**) Term: **15 Years**

(21) Appl. No.: **35/500,104**

(22) Filed: **May 15, 2015**

(80) **Hague Agreement Data**

Int. Filing Date: **May 15, 2015**

Int. Reg. No.: **DM/087193**

Int. Reg. Date: **May 15, 2015**

Int. Reg. Pub. Date: **Aug. 21, 2015**

(51) **LOC (10) Cl.** **30-03**

(52) **U.S. Cl.**

USPC **D30/129**

(58) **Field of Classification Search**

USPC D7/500, 505, 509, 538, 543, 545, 550.1,
D7/551.2, 554.3, 555, 560, 566, 571, 584,

(Continued)

(56) **References Cited**

U.S. PATENT DOCUMENTS

4,085,706 A * 4/1978 Evans A01K 5/0135
119/61.54

D294,531 S * 3/1988 Neunzig D30/130
(Continued)

OTHER PUBLICATIONS

“Snaxcup—Use Recommended Version 1.0.” SnaxCup., Dec. 1,
2014 [online], [retrieved on Mar. 17, 2017]. Retrieved from the
Internet <URL: <https://www.snaxcup-shop/>>.*

(Continued)

Primary Examiner — Darlington Ly

1.1 is a right side elevation view of a bowl showing my new design;

1.2 is a top plan view thereof;

1.3 is a front elevation view thereof; and

1.4 is a perspective view thereof.

2.1 is a right side elevation view of a bowl in accordance with a second embodiment;

2.2 is a top plan view thereof;

2.3 is a front elevation view thereof; and

2.4 is a perspective view thereof.

3.1 is a right side elevation view of a bowl in accordance with a third embodiment;

3.2 is a top plan view thereof;

3.3 is a front elevation view thereof; and

3.4 is a perspective view thereof.

4.1 is a right side elevation view of a bowl in accordance with a fourth embodiment;

4.2 is a top plan view thereof;

4.3 is a front elevation view thereof; and

4.4 is a perspective view thereof.

5.1 is a right side elevation view of a bowl in accordance with a fifth embodiment;

5.2 is a top plan view thereof;

5.3 is a front elevation view thereof; and

5.4 is a perspective view thereof.

6.1 is a right side elevation view of a bowl in accordance with a sixth embodiment;

6.2 is a top plan view thereof;

6.3 is a front elevation view thereof; and

6.4 is a perspective view thereof.

7.1 is a right side elevation view of a bowl in accordance with a seventh embodiment;

7.2 is a top plan view thereof;

7.3 is a front elevation view thereof; and

7.4 is a perspective view thereof.

(Continued)



8.1 is a right side elevation view of a bowl in accordance with an eighth embodiment;
8.2 is a top plan view thereof;
8.3 is a front elevation view thereof; and
8.4 is a perspective view thereof.

1 Claim, 32 Drawing Sheets

(58) **Field of Classification Search**

USPC D7/586; D3/304; D19/95, 107, 135;
D30/129; 220/574

CPC A47G 19/02; A47G 19/06; A47G 19/12;
A47G 23/06; A01K 5/0114; A01K
5/0142; B65D 1/34

See application file for complete search history.

(56) **References Cited**

U.S. PATENT DOCUMENTS

D373,052 S * 8/1996 Di Biase D7/553.6

D442,019 S * 5/2001 Wyche D7/354
D512,801 S * 12/2005 Kratzer D30/130
D523,185 S * 6/2006 Oliphant D30/129
D532,231 S * 11/2006 Kracke D6/536
D559,472 S * 1/2008 Abinanti D30/129
D659,914 S * 5/2012 Lipscomb D30/121
D679,548 S * 4/2013 Chen D7/545
D681,286 S * 4/2013 Namvong D30/129
D688,019 S * 8/2013 Lee D32/55
9,265,370 B2 * 2/2016 Kellow, Jr. A47G 19/065

OTHER PUBLICATIONS

Fay, Sean. "Hamburg Star Maxi Beister Invents the 'Snaxcup,' Secures European Patent." Bleacher Report., Dec. 4, 2014 [online], [retrieved on Mar. 17, 2017]. Retrieved from the Internet <URL: <http://bleacherreport.com/articles/2289155-hamburg-star-maxi-beister-invents-the-snaxcup-secures-european-patent>>.*

* cited by examiner

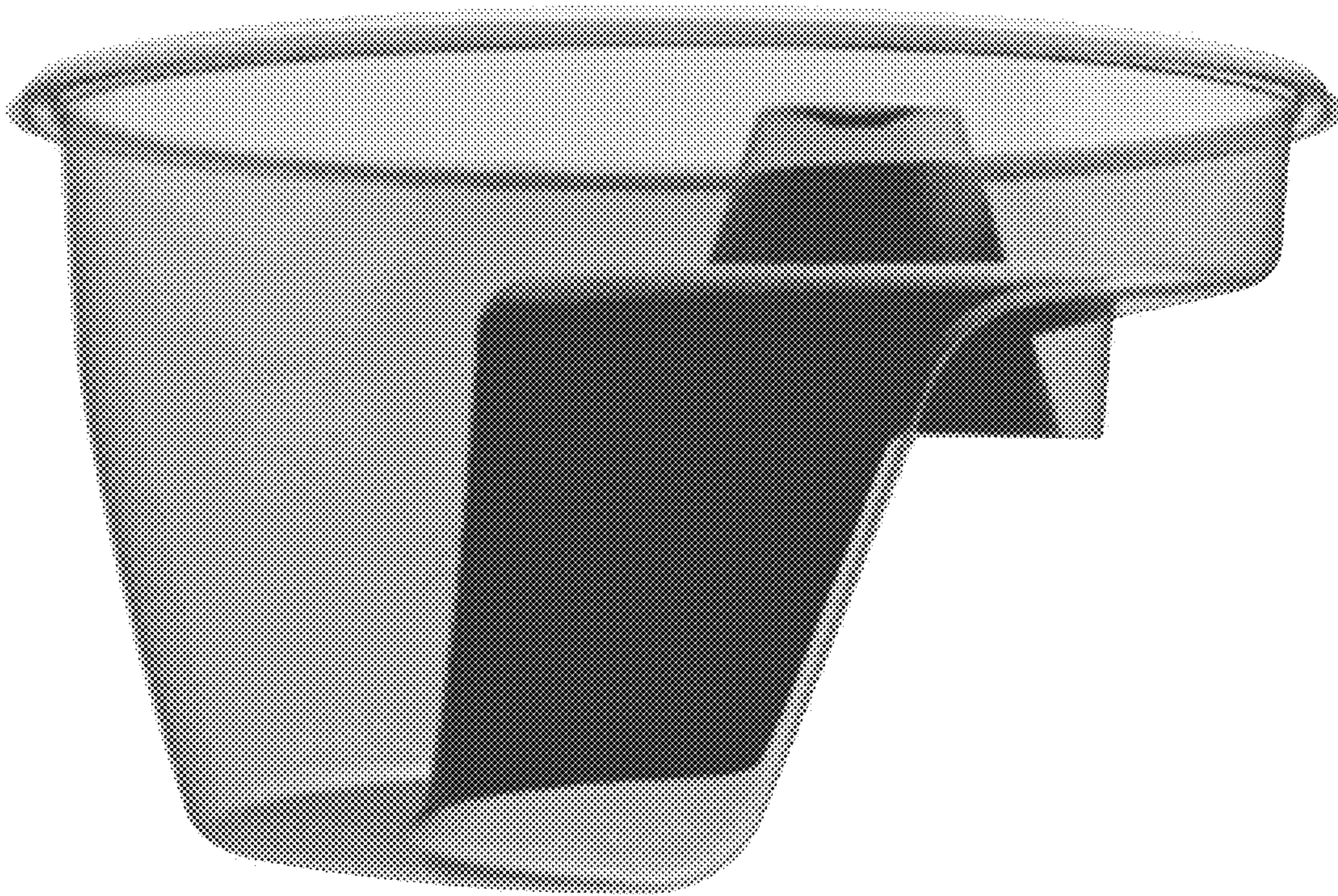

1.1



1.2

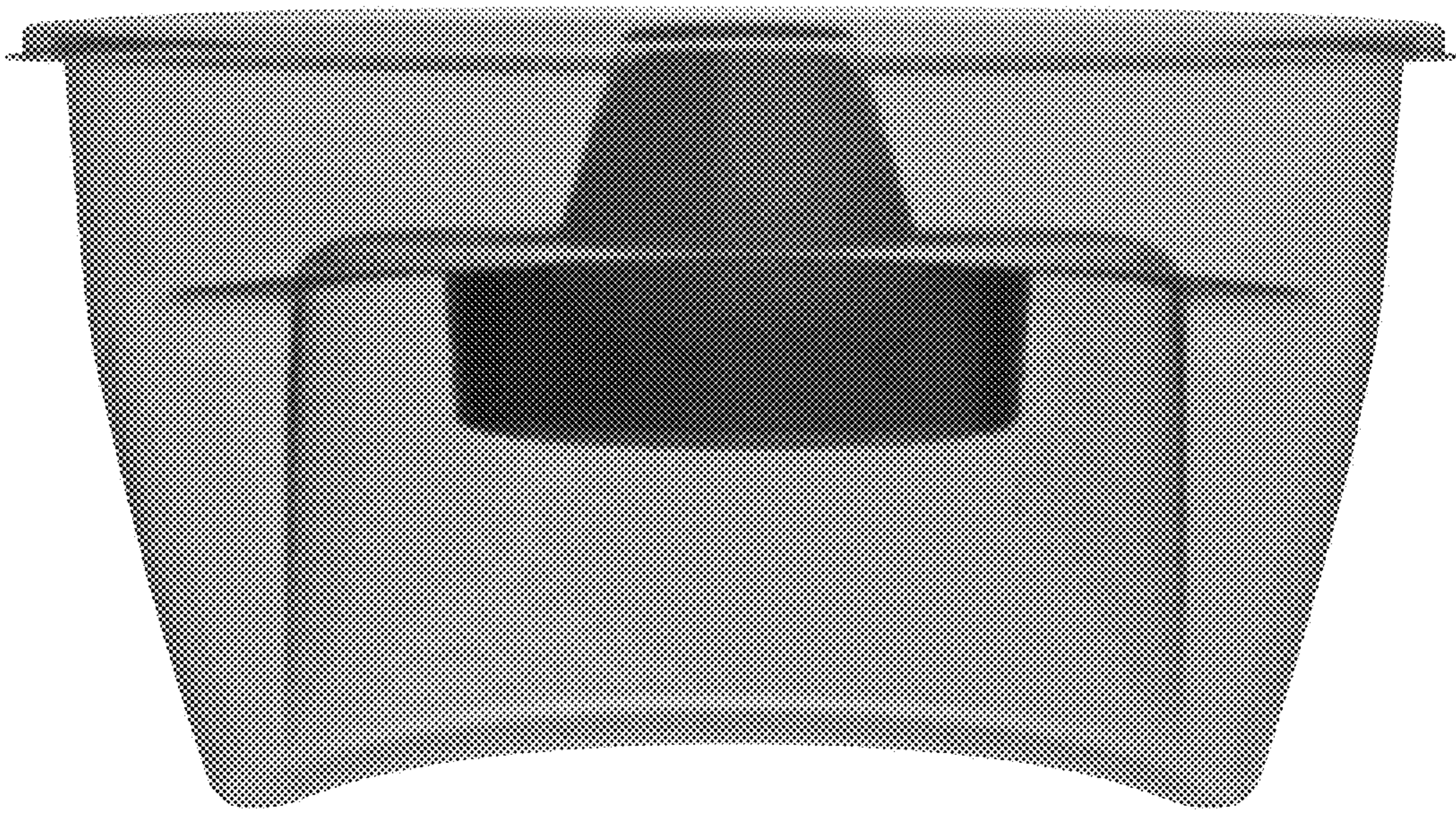

1.3

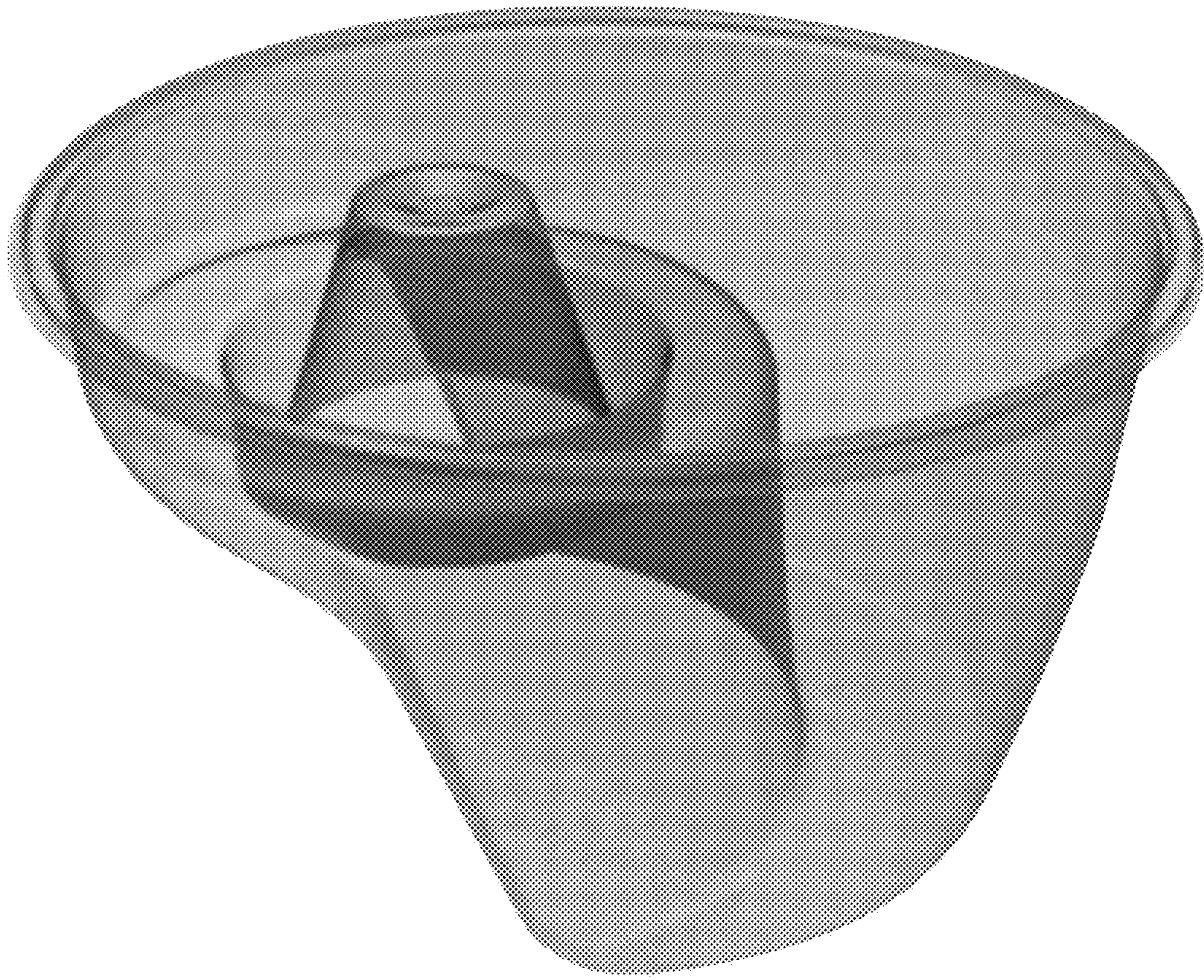

1.4



2.1



2.2

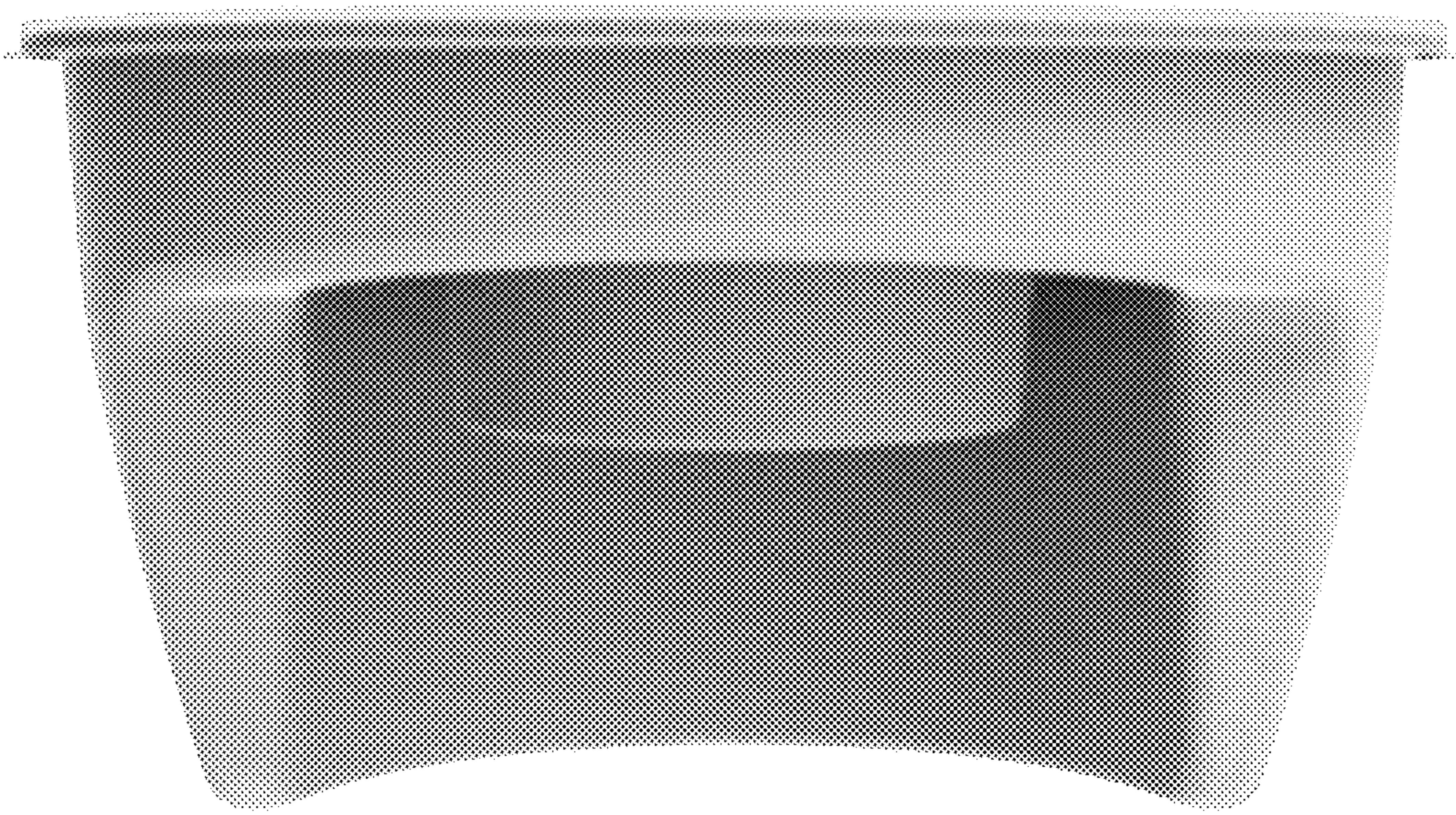

2.3



2.4

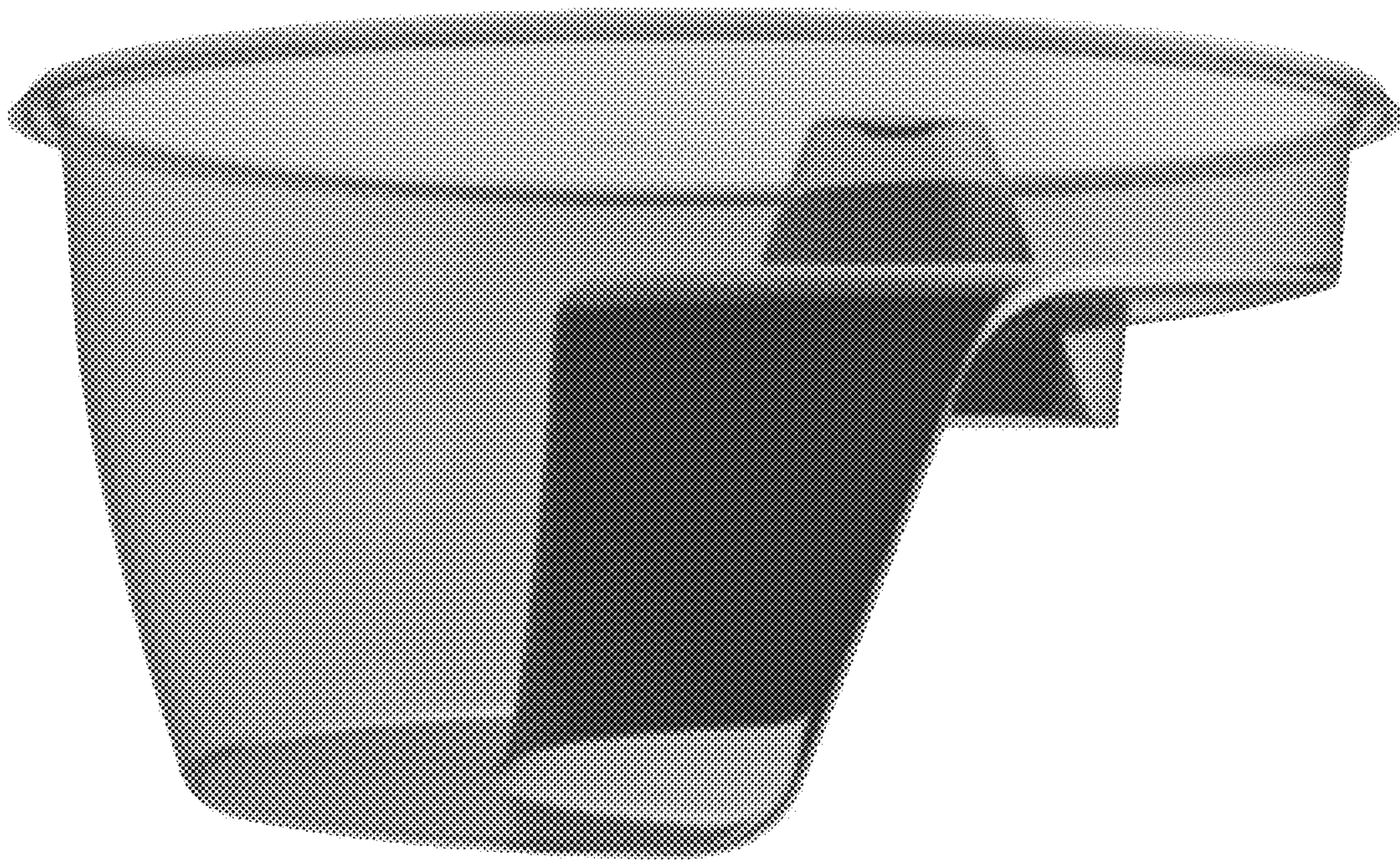

3.1

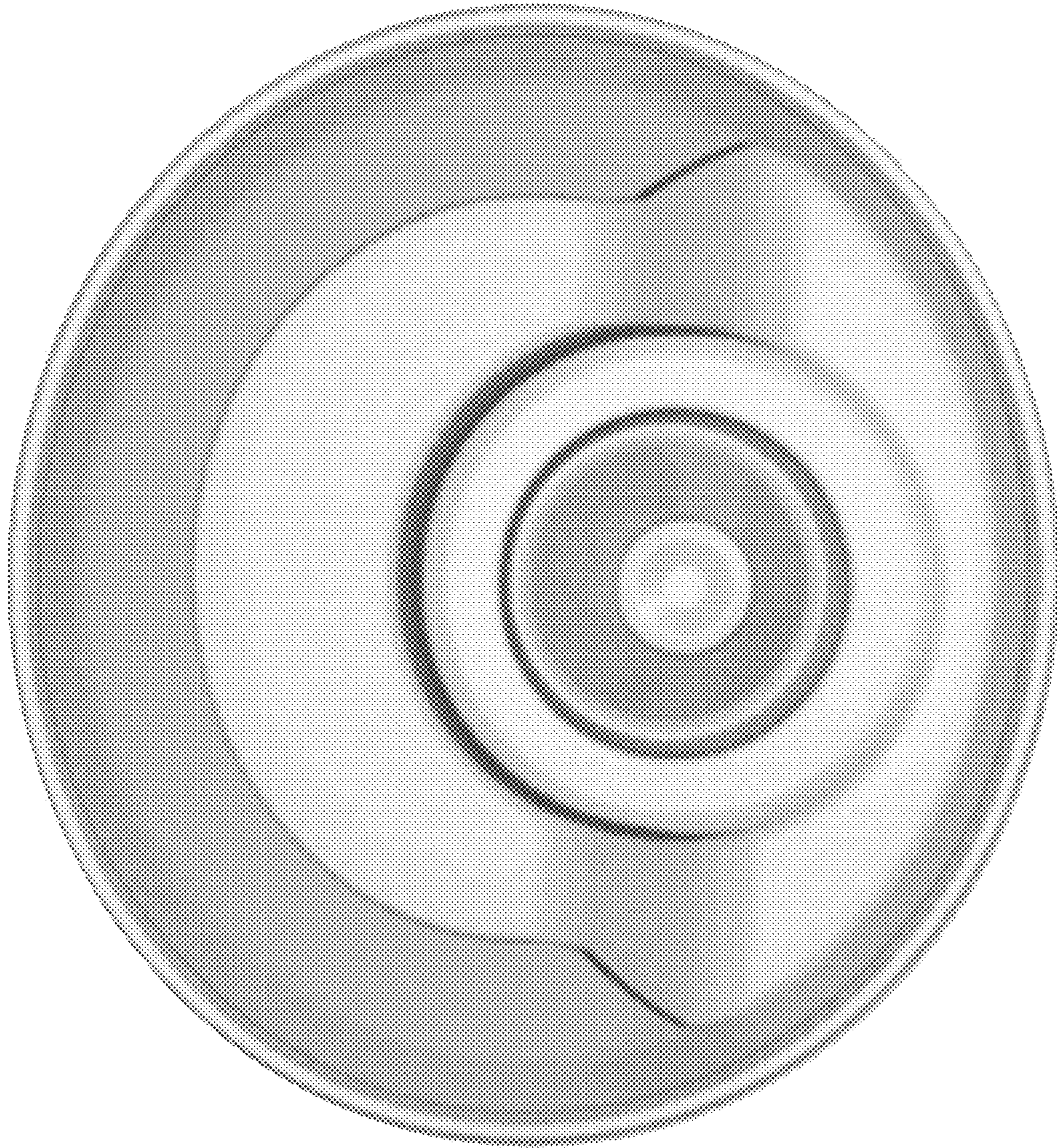

3.2

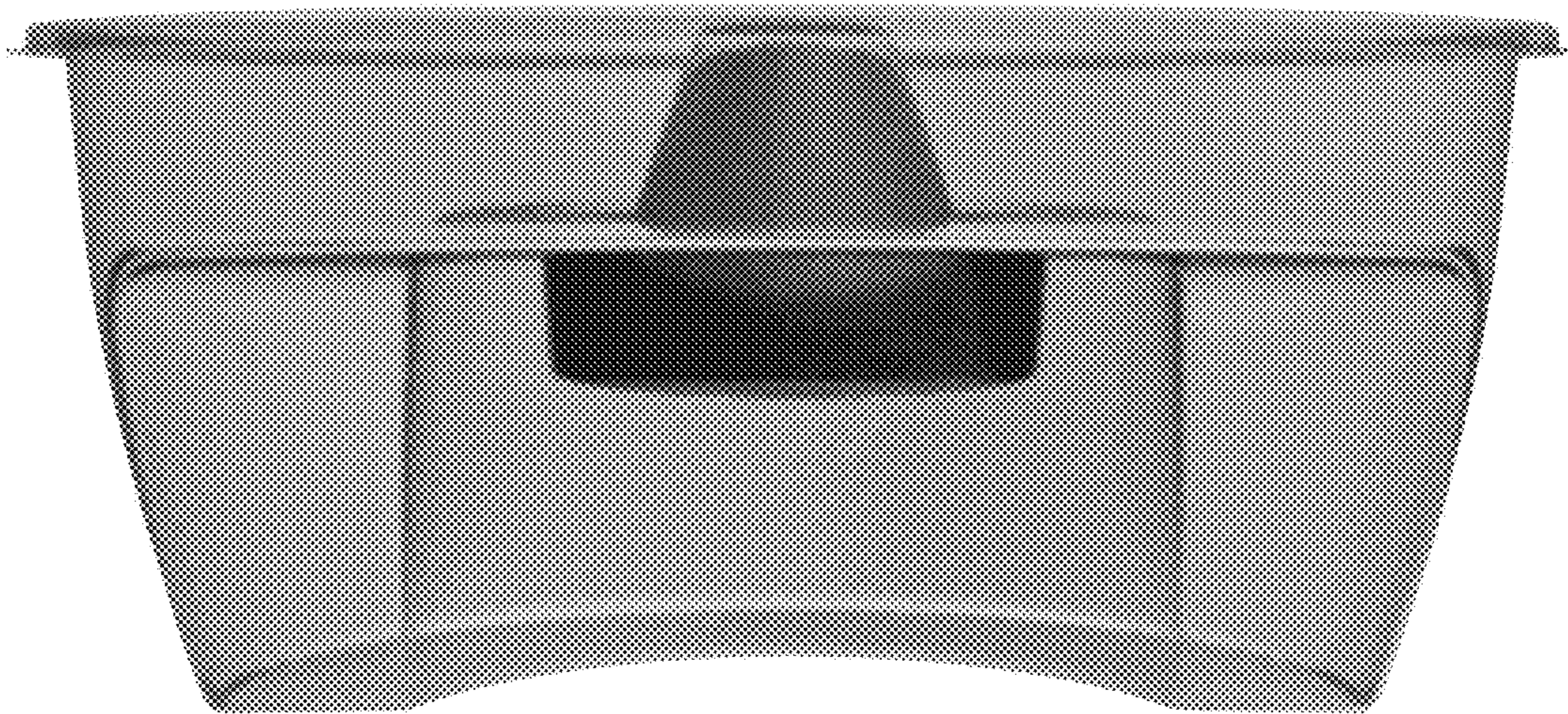

3.3

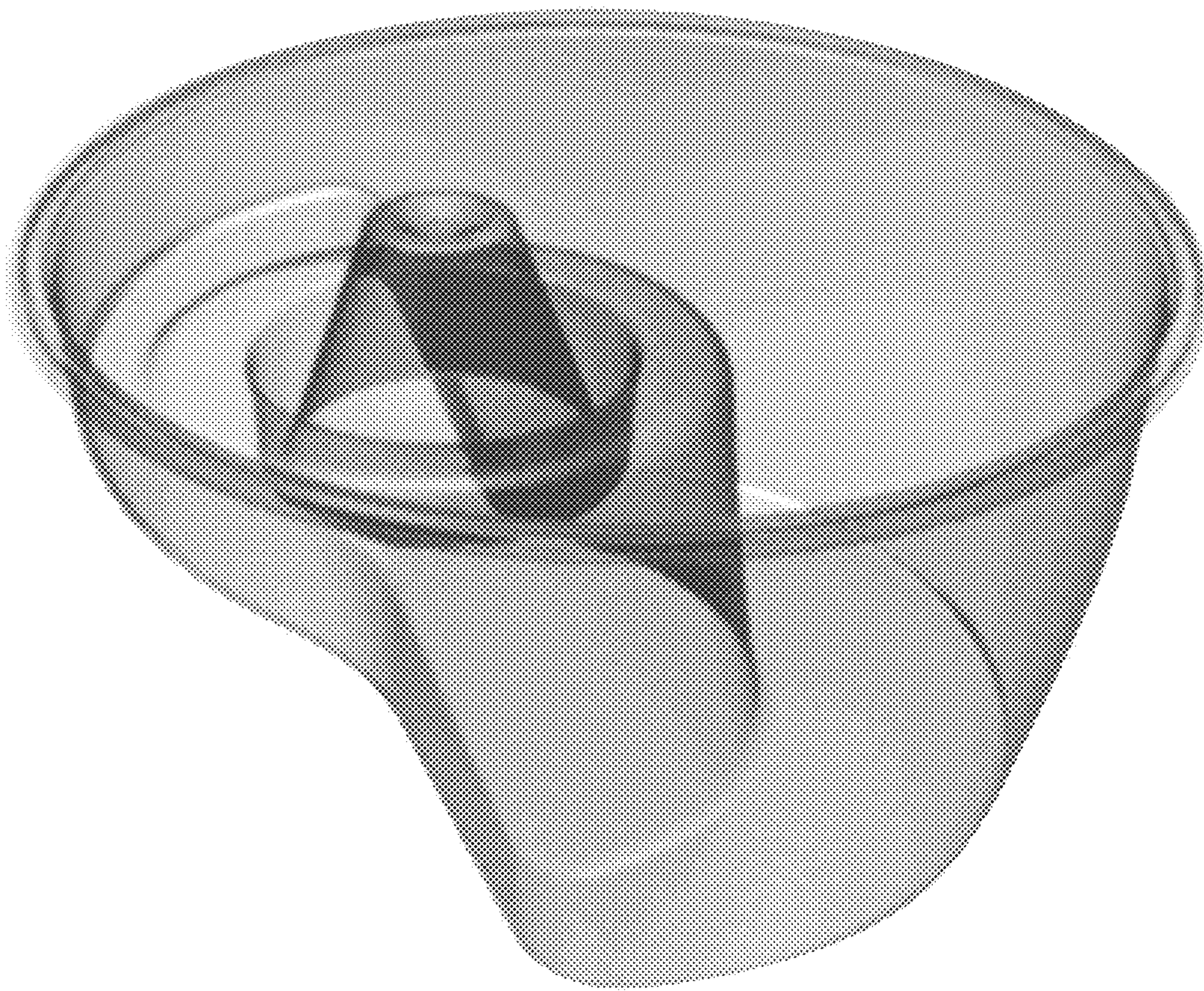

3.4

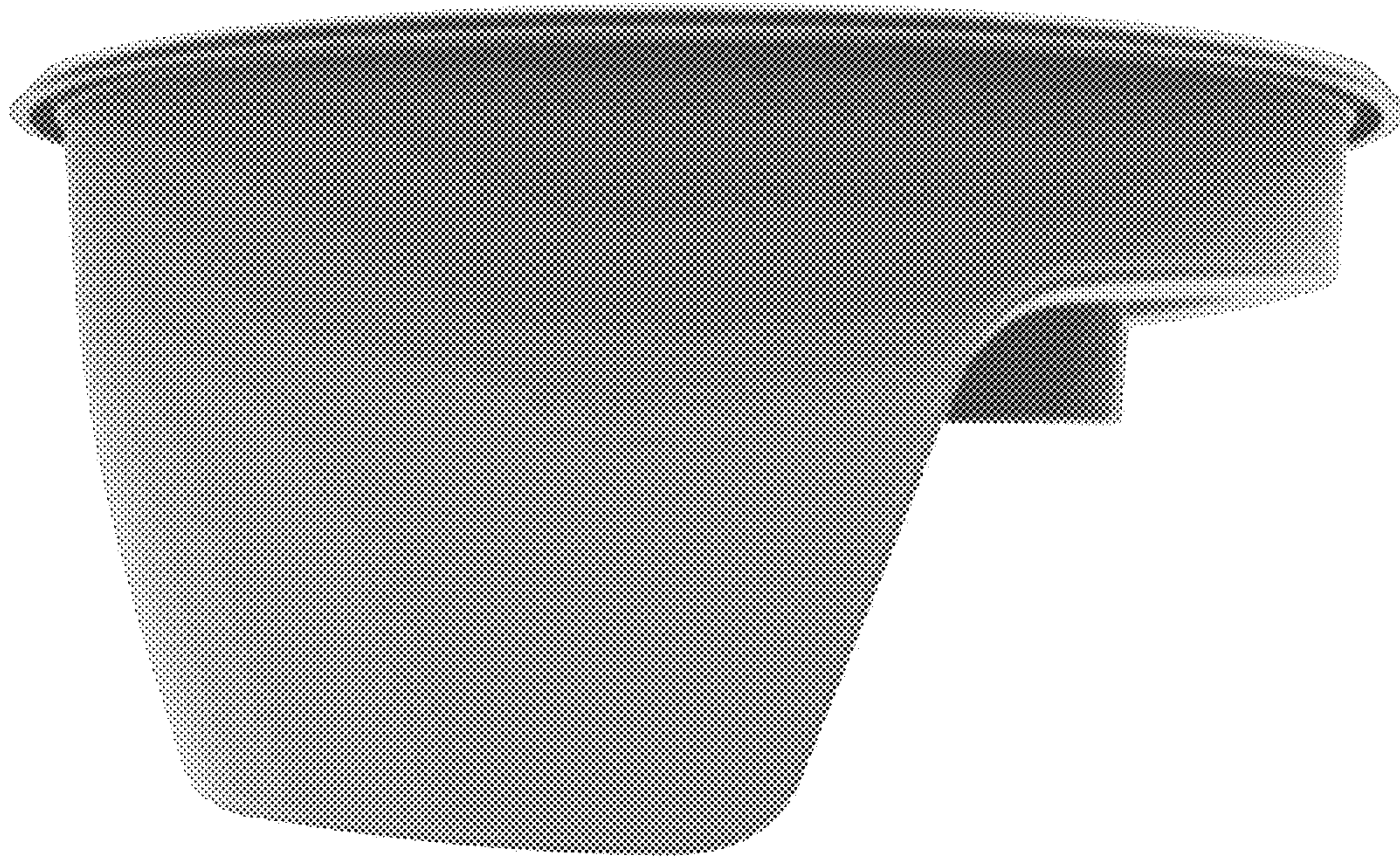

4.1

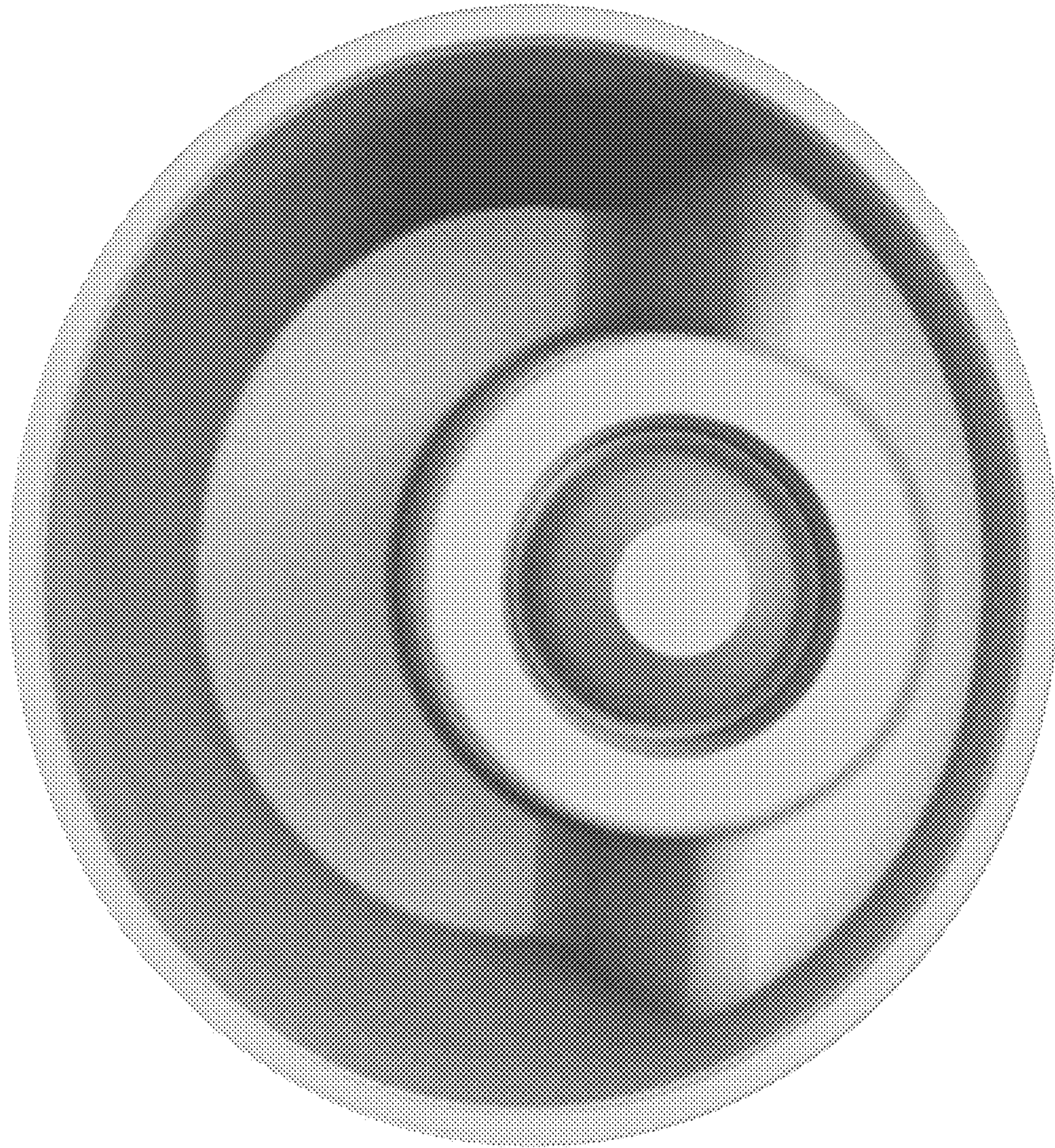

4.2

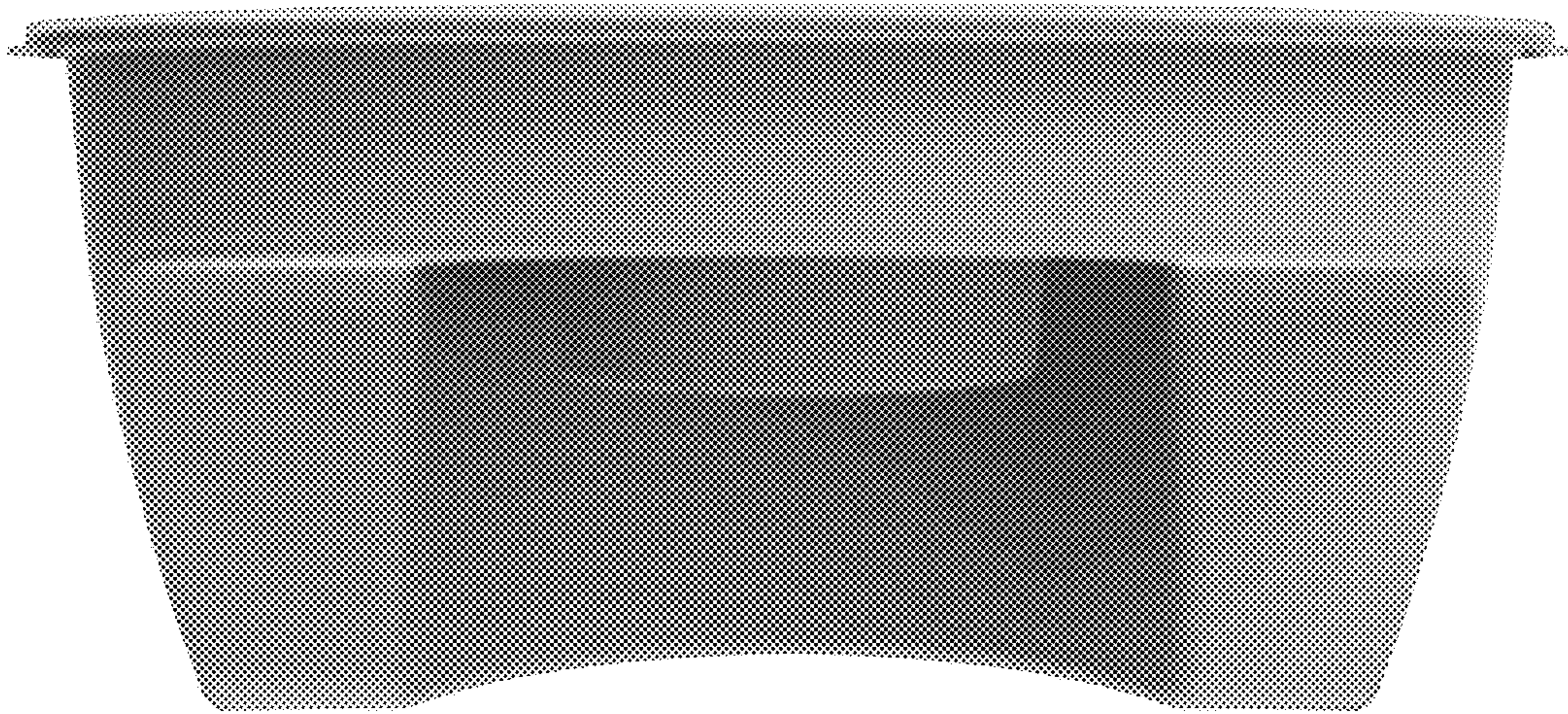

4.3



4.4

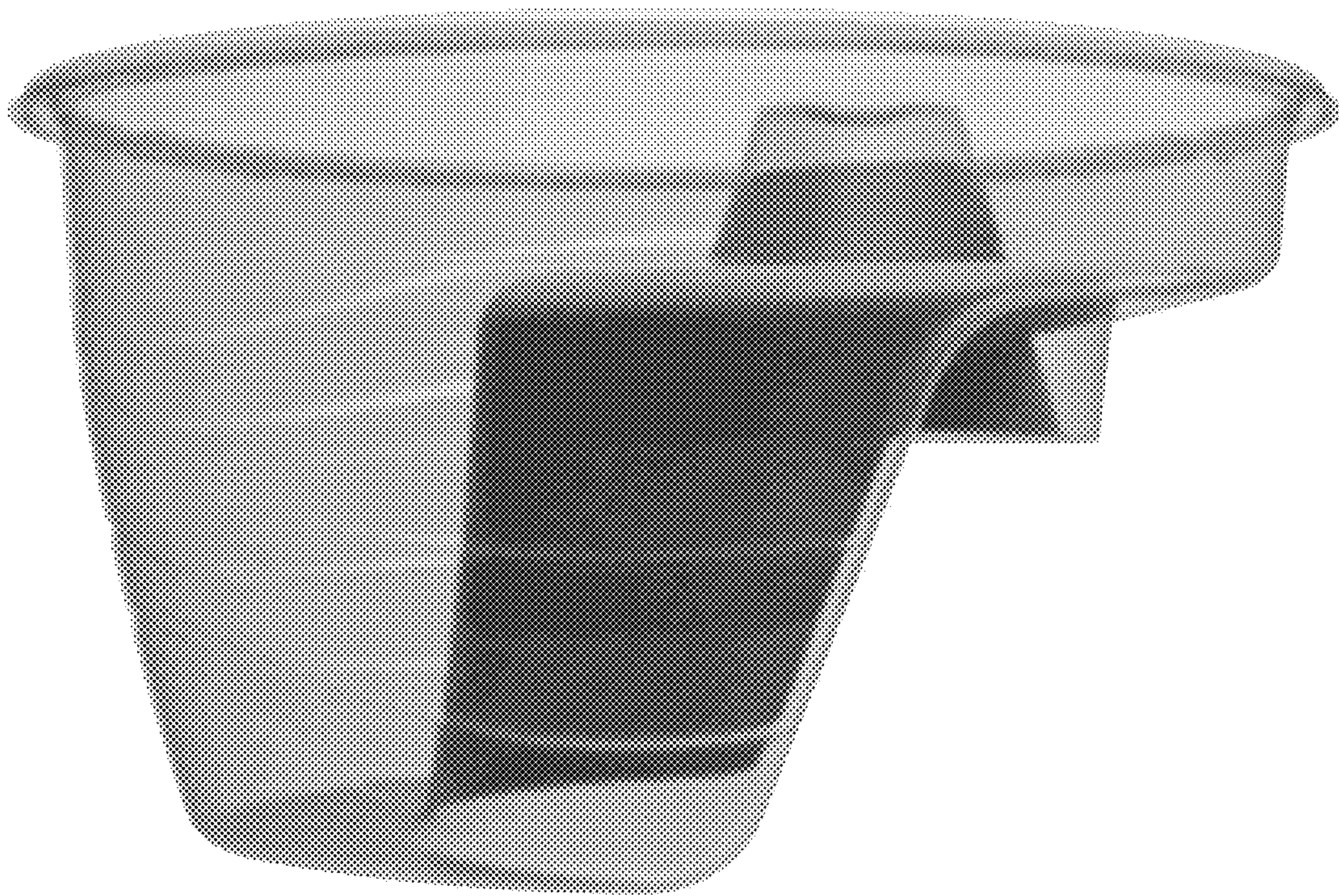

5.1

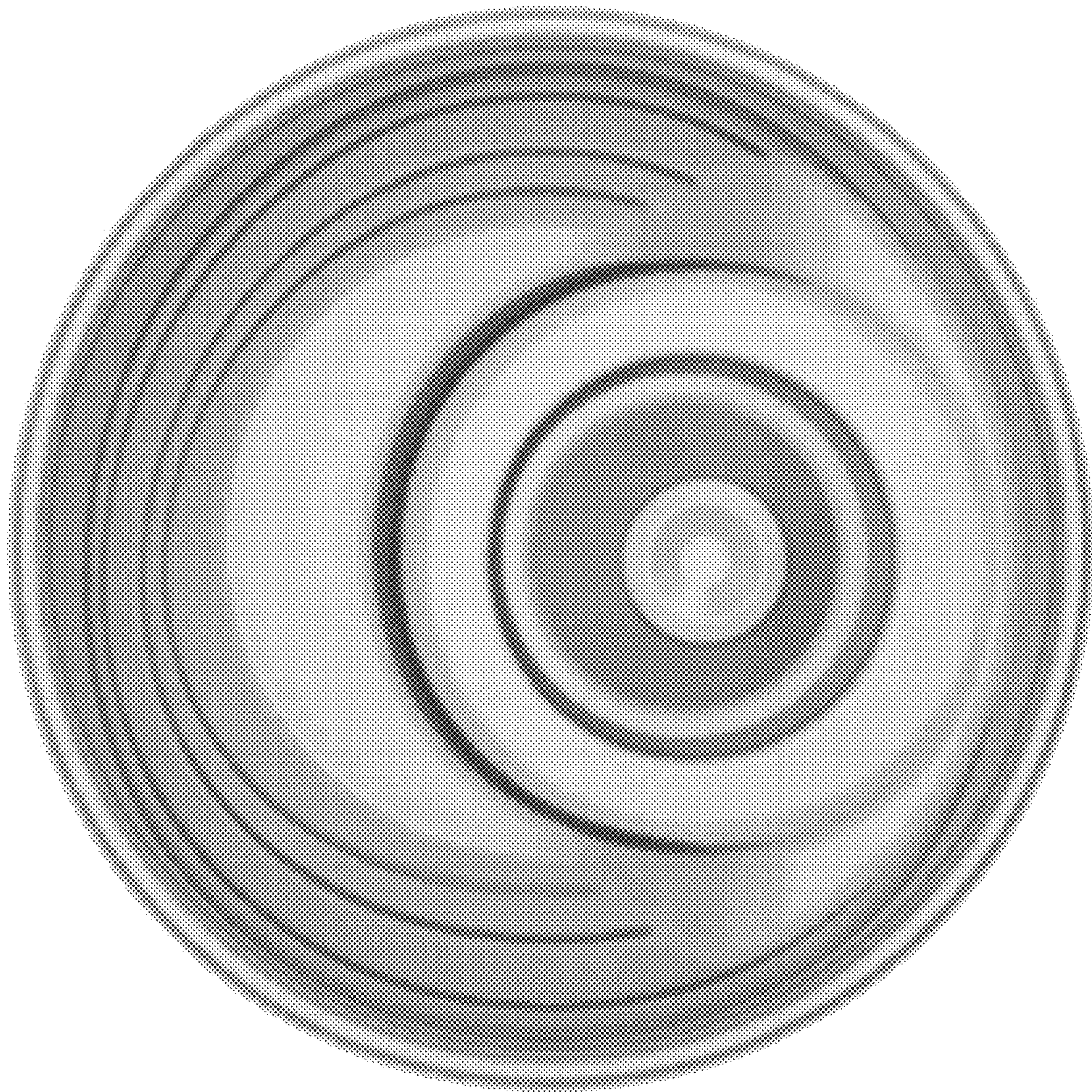

5.2

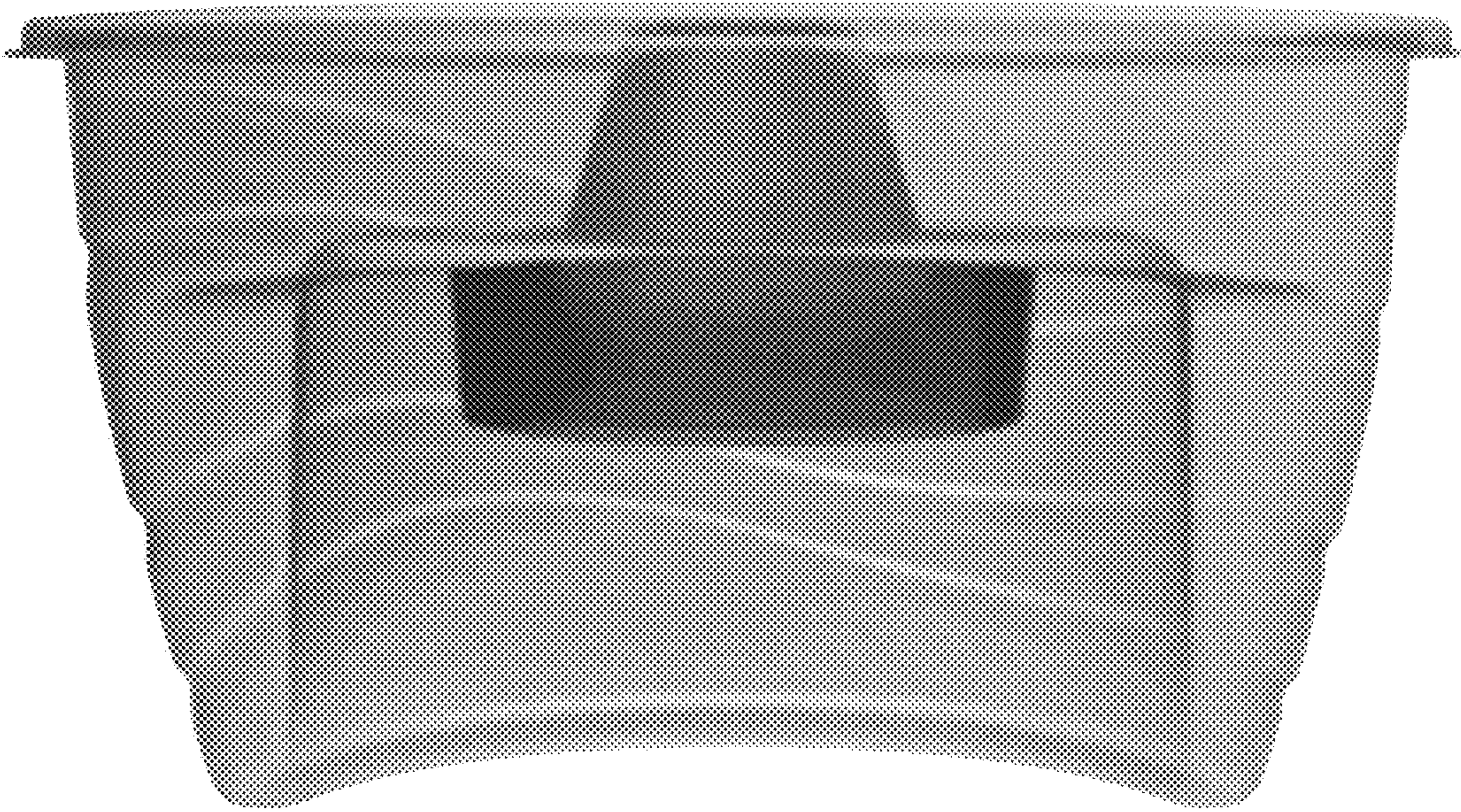

5.3

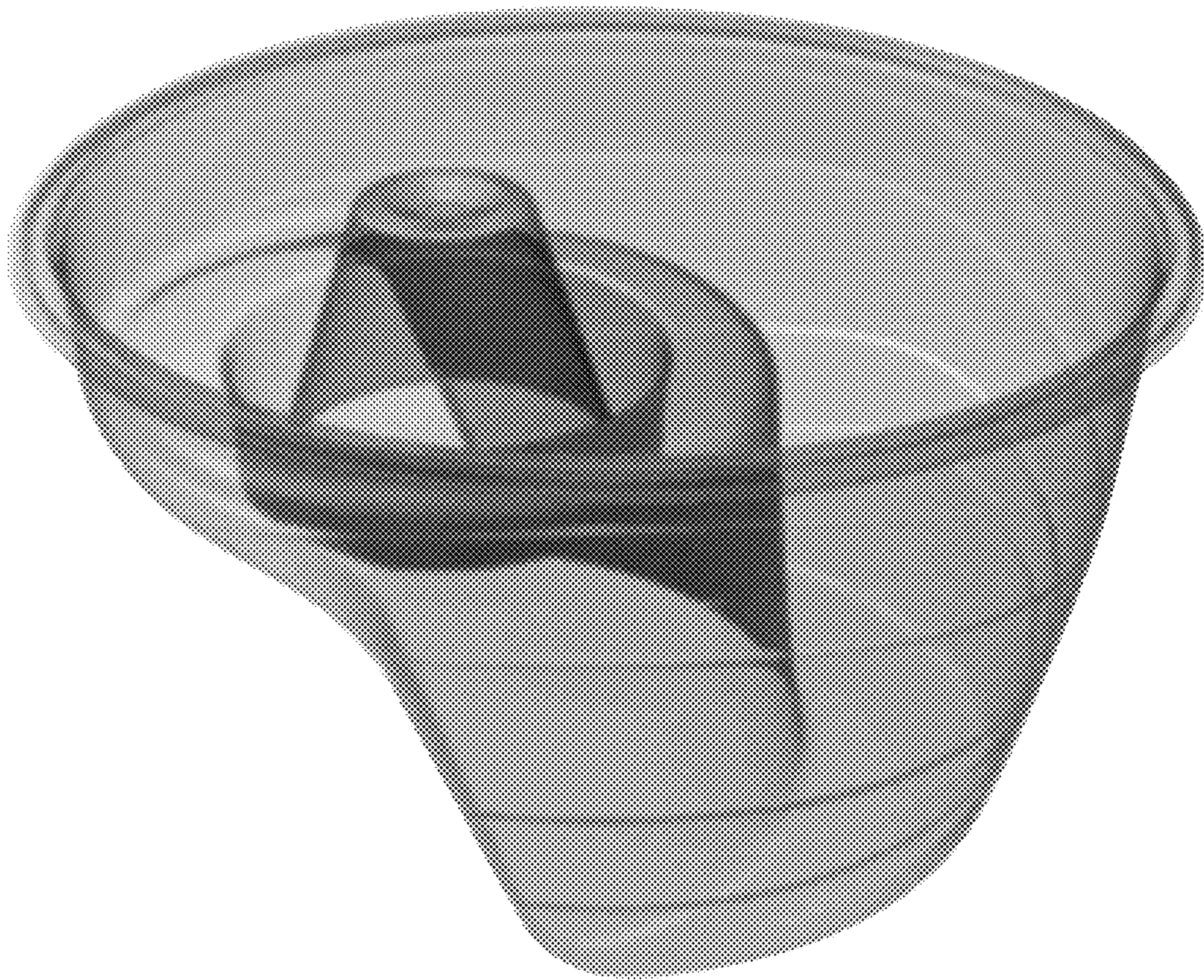

5.4



6.1



6.2

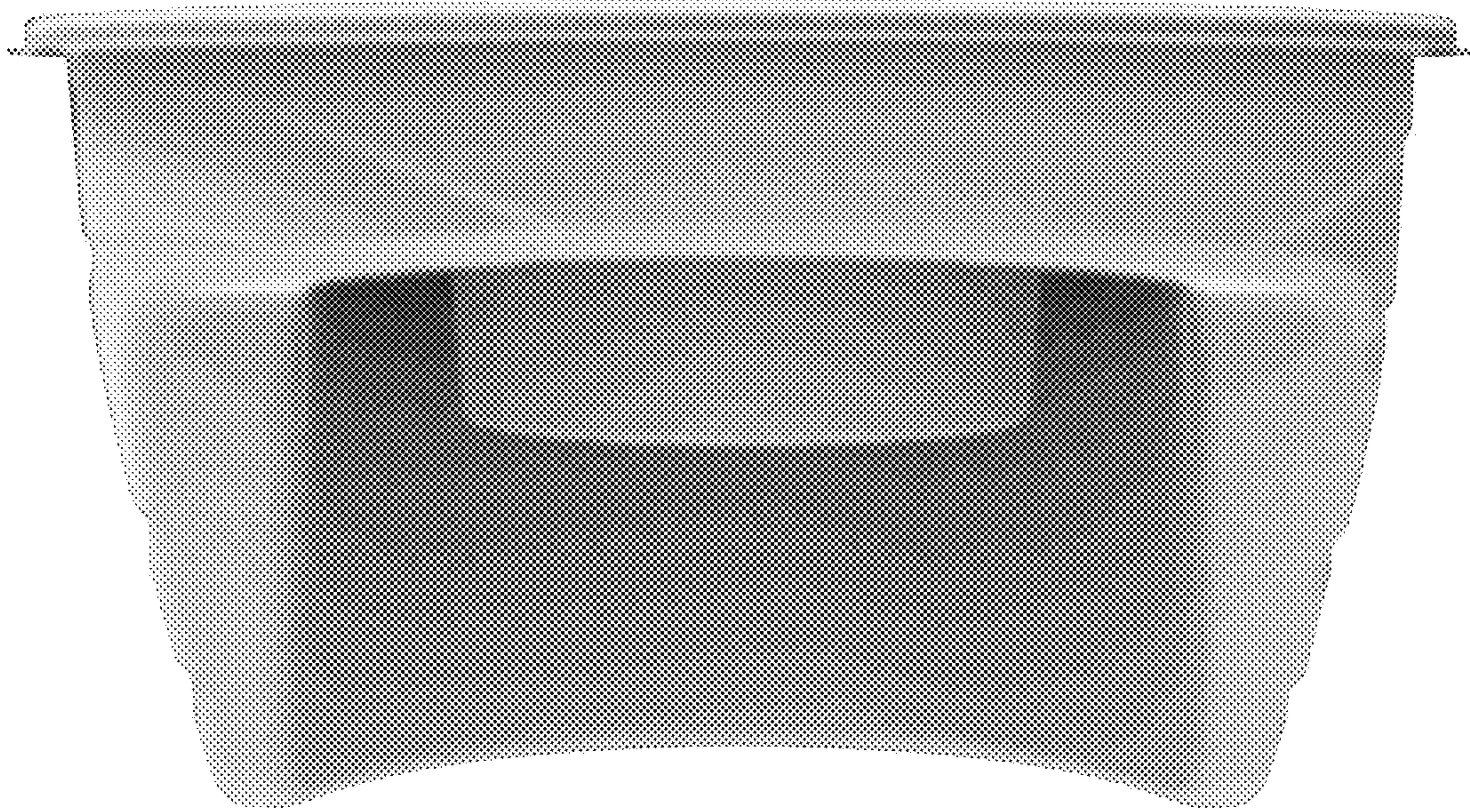

6.3



6.4

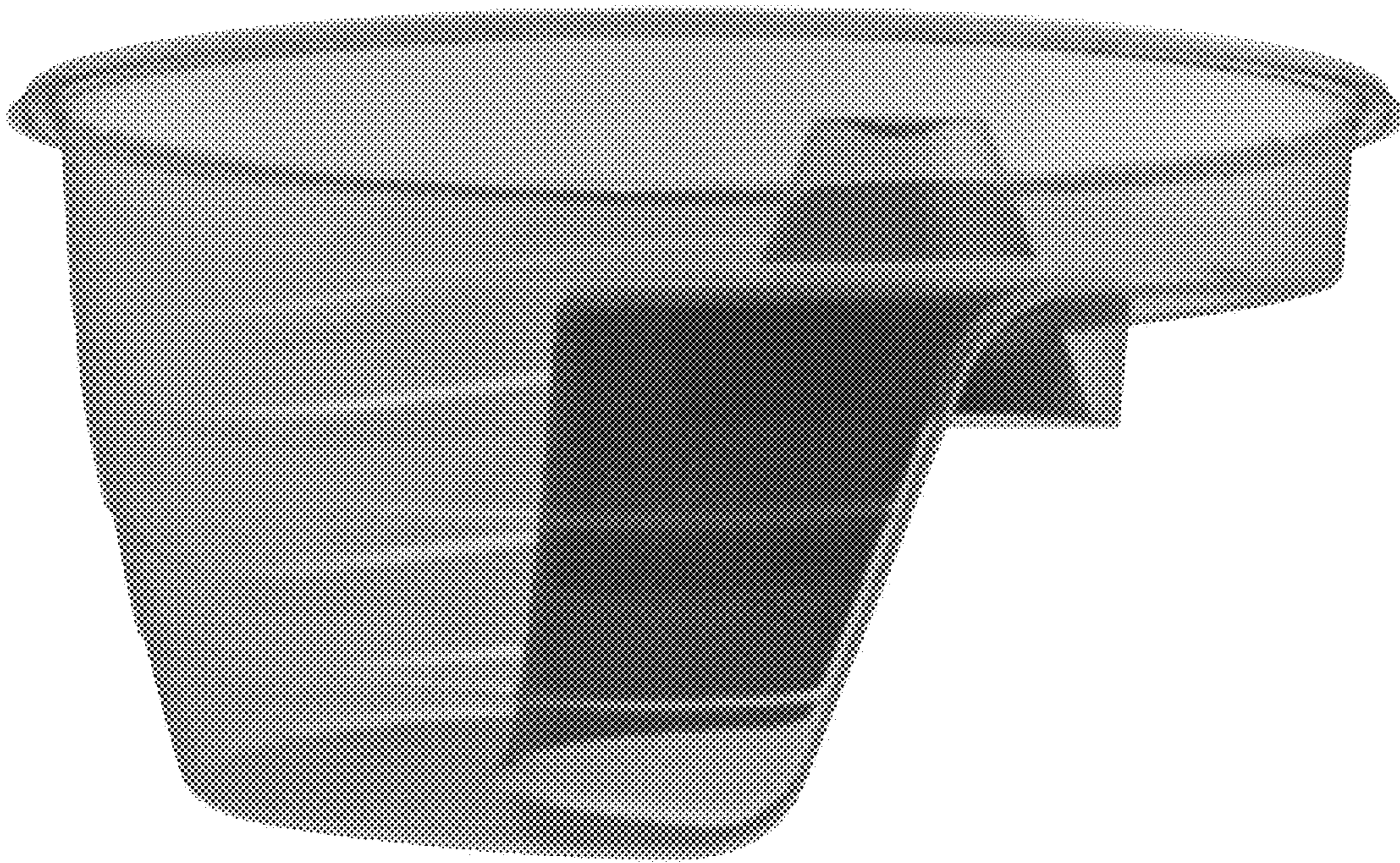

7.1

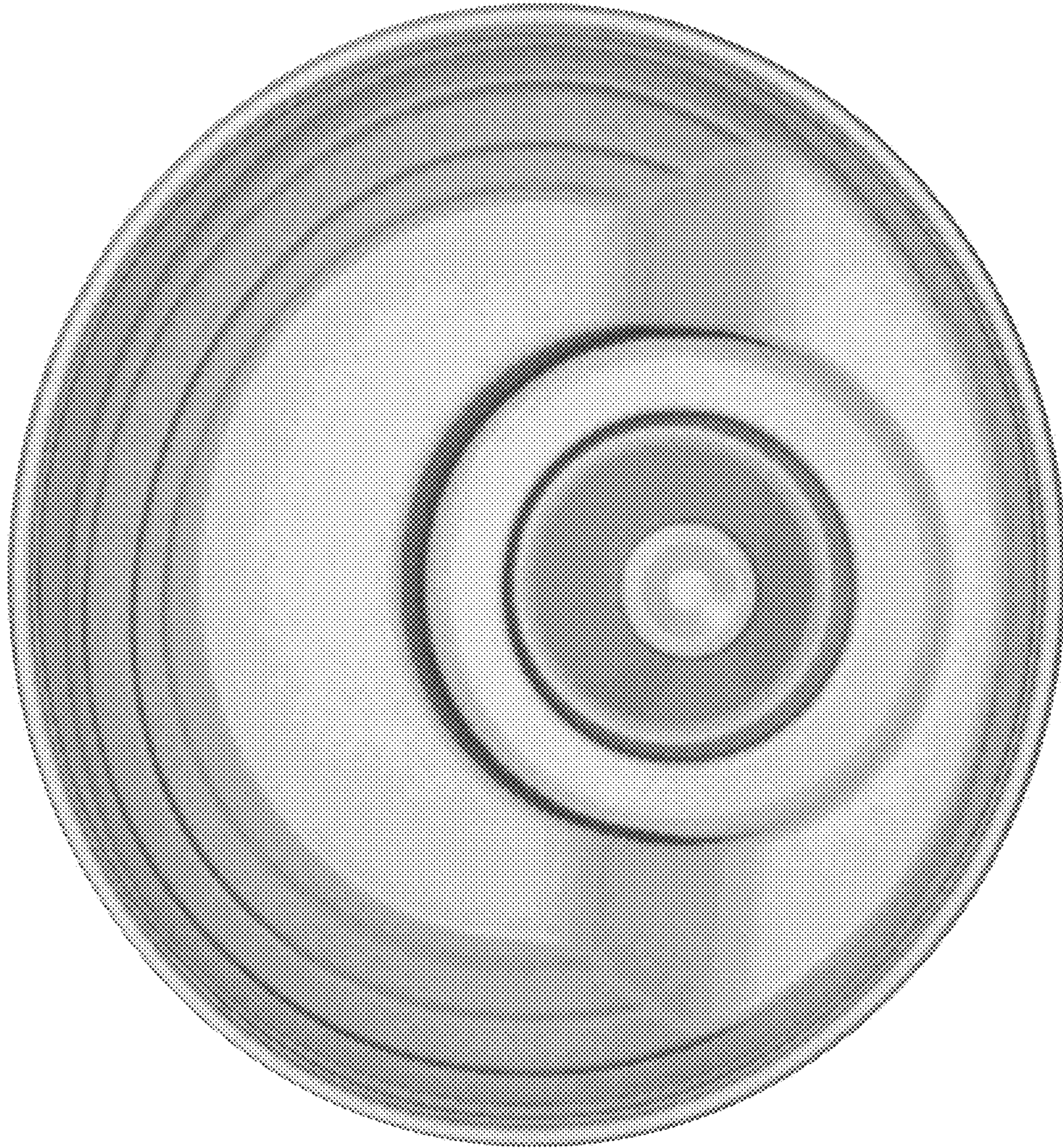

7.2

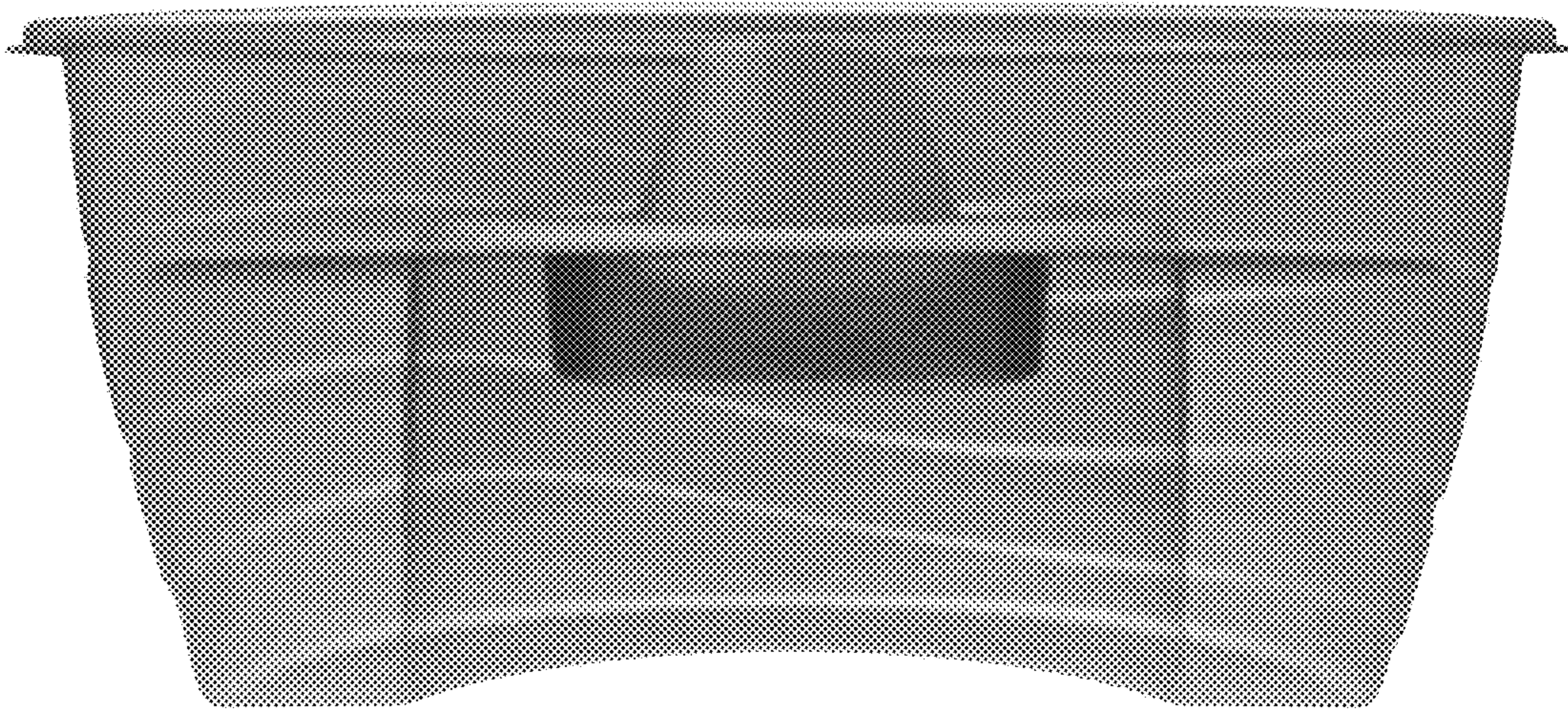

7.3

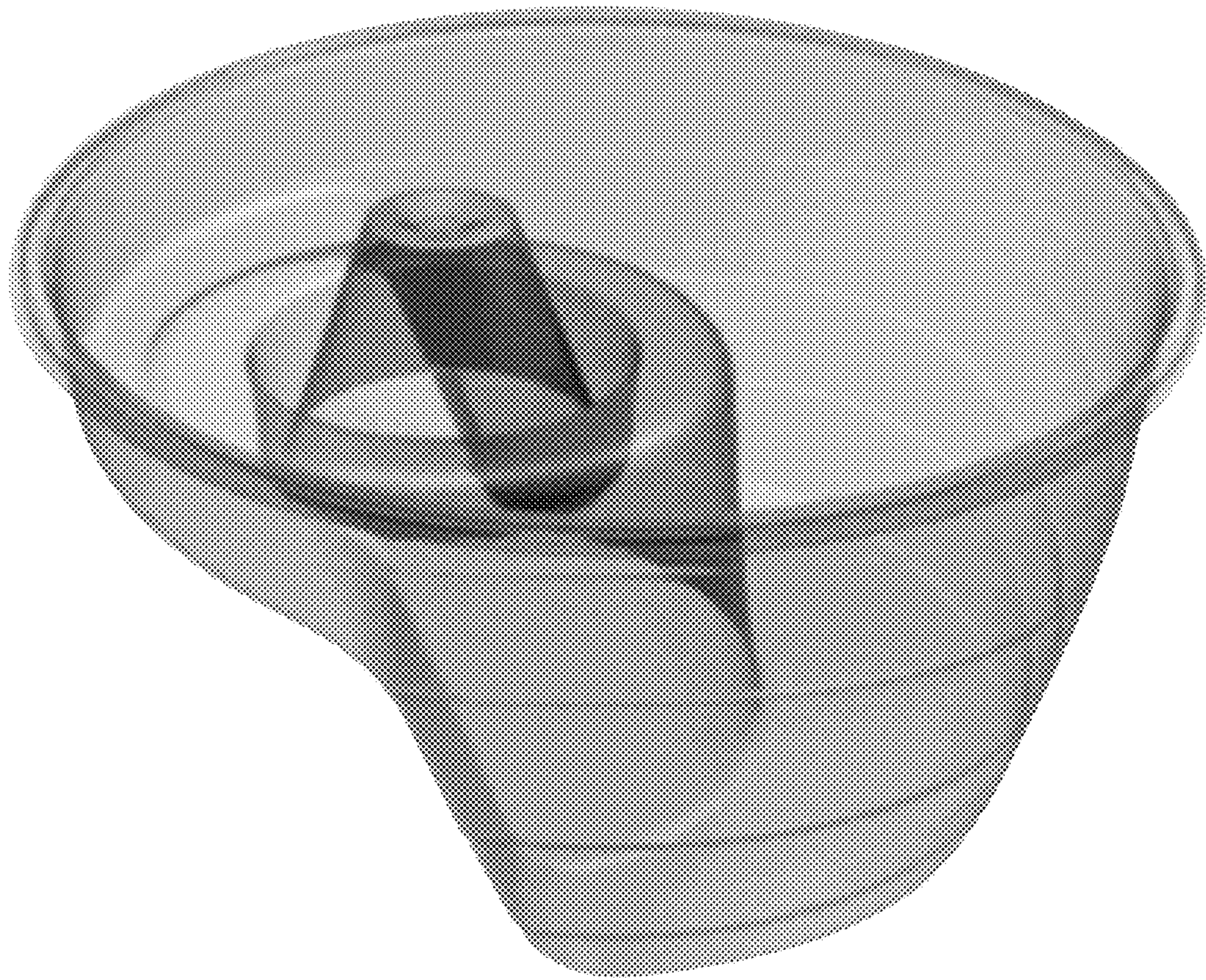

7.4

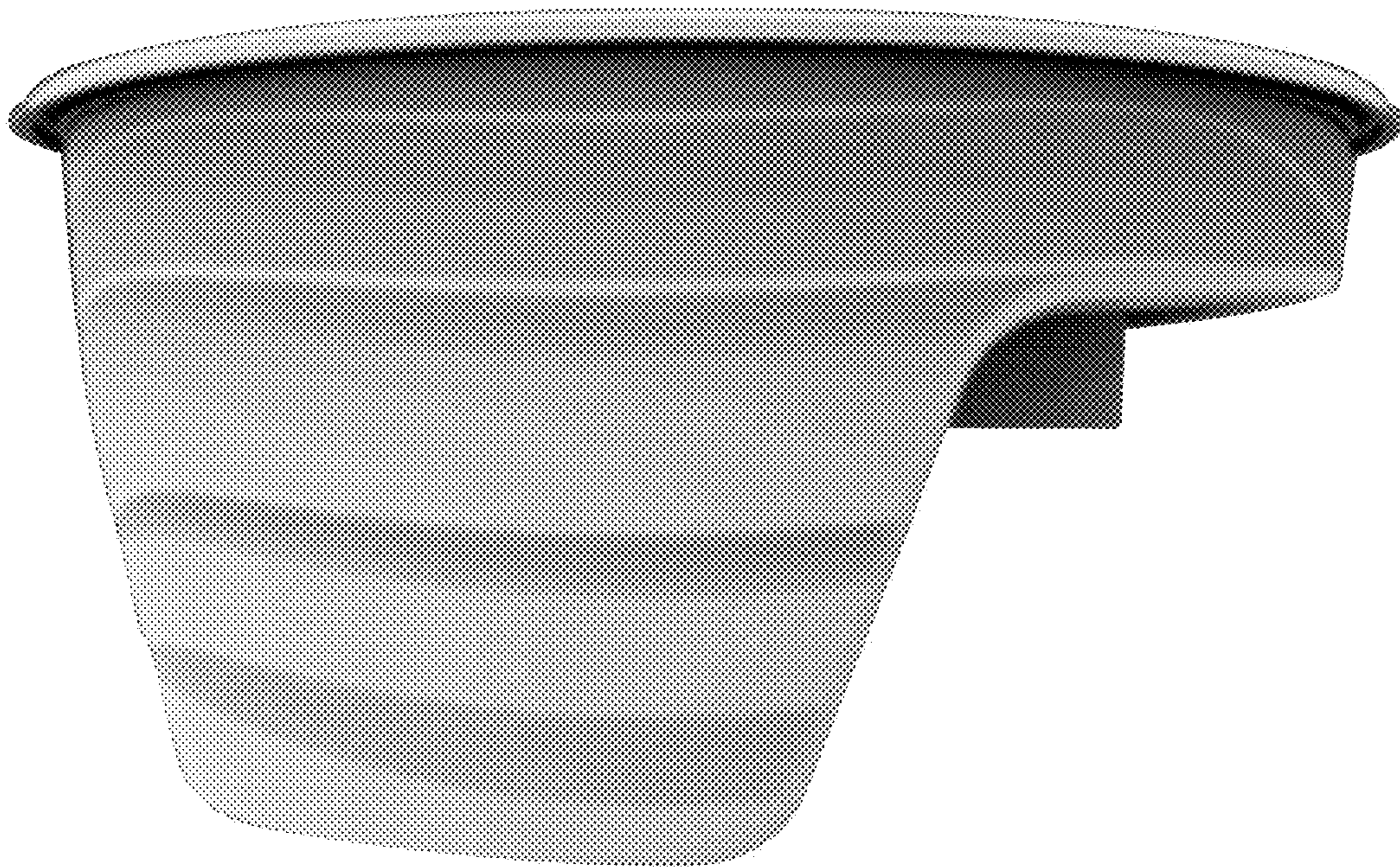

8.1

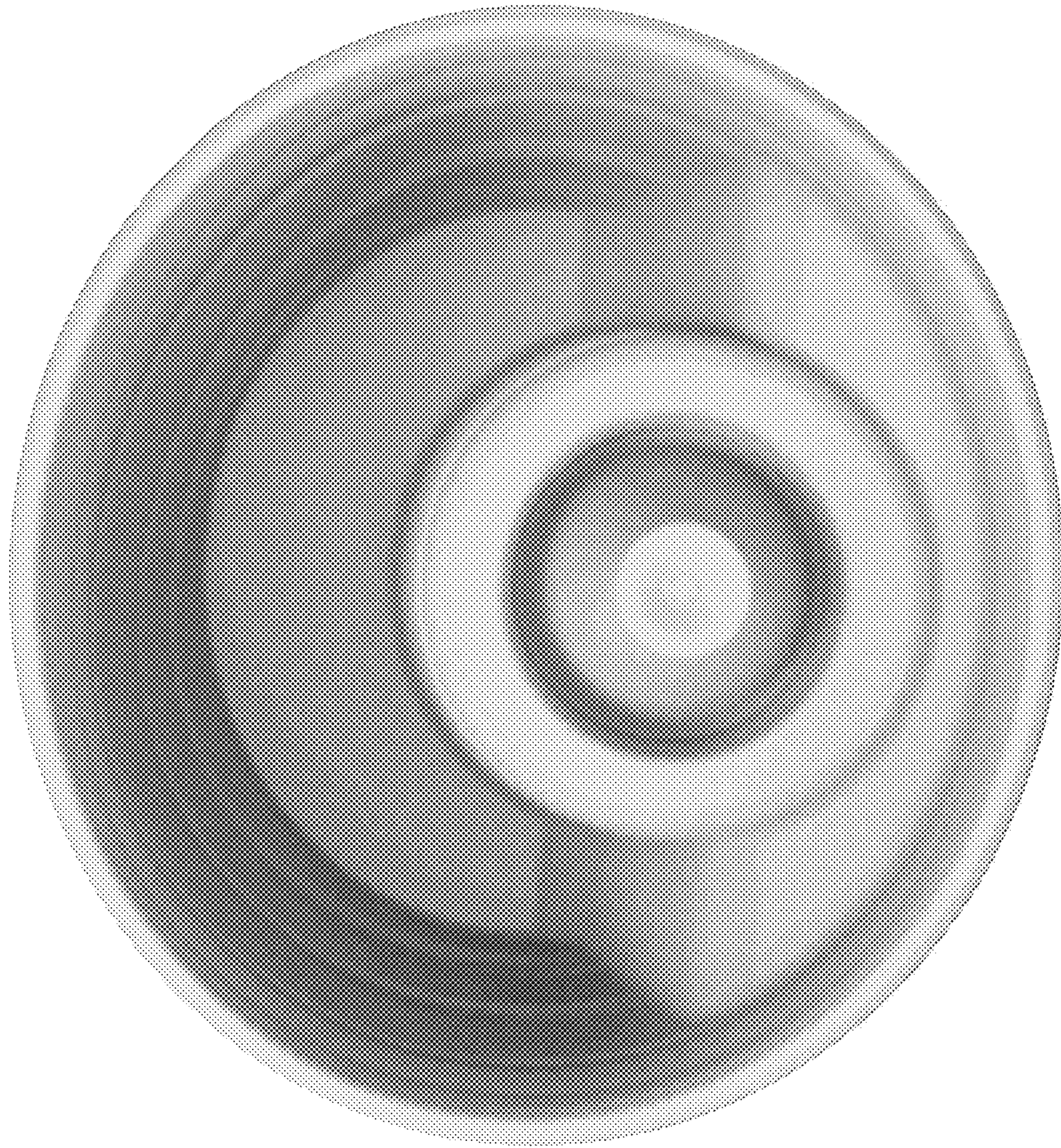

8.2

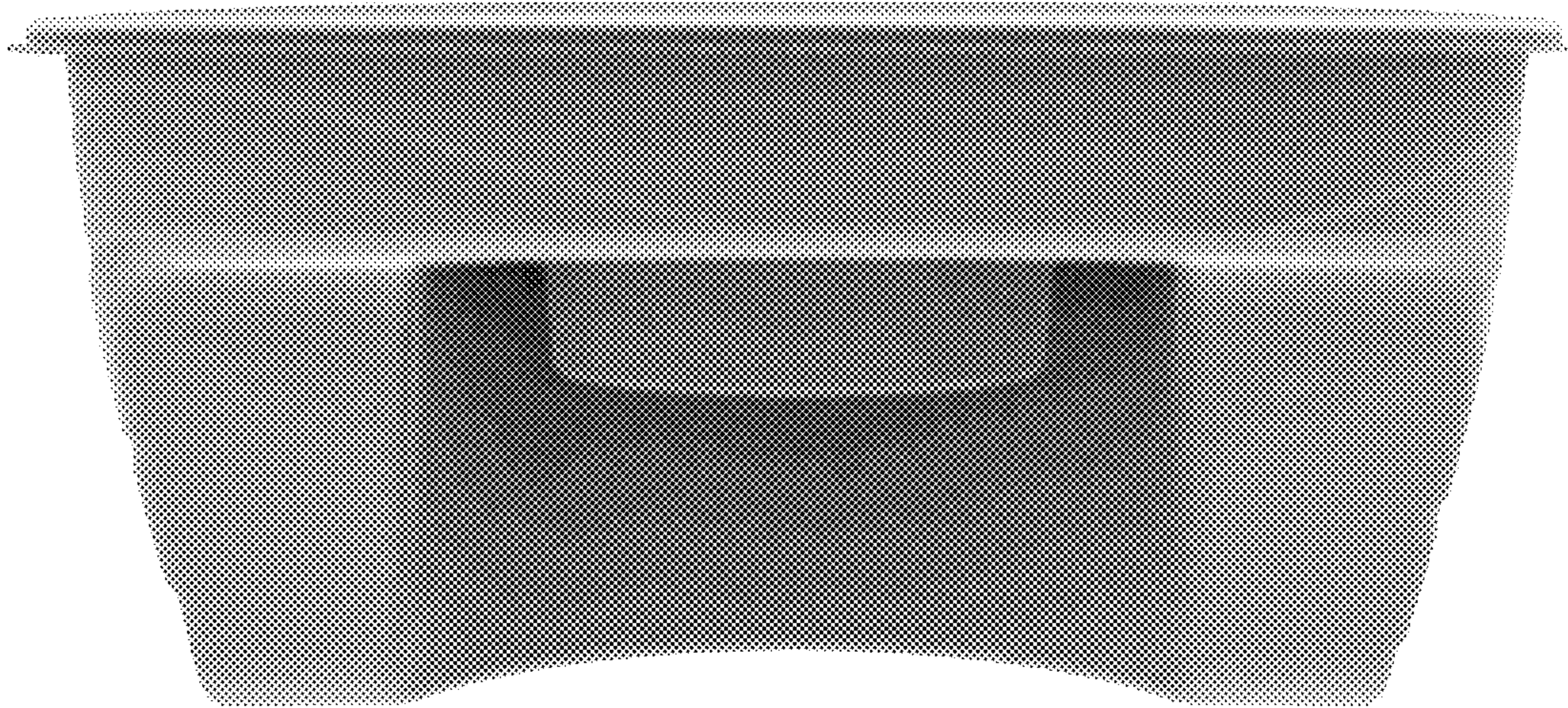

8.3



8.4